



FM Series

The compact FM Series foot switches are appropriate for light or medium duty and medical applications. With a wide range of options, this series offers a greater amount of flexibility, for a reasonable price.

<i>Application</i>	4
<i>FM1</i>	5
<i>FM1 ... U</i>	6
<i>FM2</i>	7
<i>FM3</i>	8
<i>FM3-Ergonomic</i>	9



PCFS-3M Series

Altech's new low cost foot switch is ideal for any light to medium duty application. The PCFS-3M has an electrical rating of 10A/1/2HP/125V AC, it can serve as a foot operated on/off switch for a wide range of motor driven and electrical devices.

<i>Application</i>	10
<i>PCFS-3M / PCFS-3MU</i> <i>(with and without guard)</i>	11



FK Series

The medium compact FK Series foot switches are ideal for light or medium duty applications, where there is no demand for high protection levels. It is a foot switch for low cost needs with a larger pedal than the FM Series.

<i>Application</i>	12
<i>FK1</i>	13



FL Series

The light medium size FL Series foot switches are used where heavy duty applications in hazardous environments require a corrosion-resistant, control device.

<i>Application</i>	14
<i>FL1</i>	15
<i>FL1 ... U</i>	16



FS Series

The heavy duty medium size FS Series foot switches are suitable for industrial and medical applications. A special safety switch is included with this line.

<i>Application</i>	18
<i>FS1</i>	19
<i>FS1 ... U</i>	20
<i>FS2</i>	21
<i>FS2 ... U</i>	22
<i>FS3</i>	23
<i>FS3 ... U</i>	24

Custom Designs

Altech Corp can design and manufacture a foot switch to meet needs.

<i>Custom Designs</i>	17
-----------------------------	----



Information

<i>Warnings</i>	25
<i>Series Features</i>	26-27
<i>Switch Specifications</i>	28
<i>Options</i>	29
<i>Terms & Conditions</i>	30



Please see page 25 in reference to the warning that applies to every application.

FM SERIES



The FM series foot switches are ideal for light or medium duty applications and especially medical applications. The compact, sturdy but small, ABS housing is designed to meet all the different contact and switch insert configurations.

This series has many features, such as maintained and two stage momentary contacts, two different colors, and two protection levels. It also offers a variety of flexibility and alternatives already in the standard versions. The wide range of options include:

- Protection levels IP 68 (Medical versions IEC 601-1 certified)
- Especially designed gold plated contacts for low current
- High current switch inserts
- Different cable entries/strain reliefs
- Other cable versions, with shield
- Custom colors for the guard, custom connectors.

The standard and optional features together provide various application possibilities:

Foot switches are typically used when hands-free operation is required or when the hands are needed to perform a separate task while the machine or device must be started or stopped, or the machine requires manipulation in other ways. Application examples would be:

- Conveyor belt in supermarket
- Sewing machine in textile factory
- Control of dentistry tools
- Operation of logical or digital signals

Warning

Please see page 25 in reference to the warning that applies to every application.



FM1

- Compact, one pedal foot switch

Standard Features

- Housing: Gray or black ABS body and pedal cover
- Protection Level: IP 43 and IP 65
- Switch Insert: Snap action microswitch, UL/CSA approved
 - Electrical Rating: 5A/125-250V AC (If used with appropriate cable, see cable chart on page 29)
 - Contact Types: Momentary, maintained, or two stage momentary
 - Circuit: SPDT-SB, DPDT-SB, 2x SPDT-SB
- Strain Relief: Vinyl sleeve
- Cable:
 - Multi conductor, PVC, SJT, 2 m (6 ft. - 6 in.)
 - Without Cable
- Temperature Range: -20°C up to +80°C (-4°F up to +176°F)



Ordering Information

Type	Catalog No.	Circuit Function	Electrical Ratings	Switch/Contact Type	Cable	Protection Level
FM1 ... L1						
FM1 SU1 L1	51.601	<input type="checkbox"/>	SPDT-SB	5A/250V AC	Snap Action, Momentary	None (Solderable) IP 43
FM1 SU2 L1	51.607	<input type="checkbox"/>	DPDT-SB	5A/250V AC	Snap Action, Momentary	None (Solderable) IP 43
FM1 SU1R L1	51.604	<input type="checkbox"/>	SPDT-SB	5A/250V AC	Snap Action, Maintained	None (Solderable) IP 43
FM1 SU2R L1	51.610	<input type="checkbox"/>	DPDT-SB	5A/250V AC	Snap Action, Maintained	None (Solderable) IP 43
FM1 SU1DSU1 L1	51.613	<input type="checkbox"/>	2x SPDT-SB	5A/250V AC	Snap Action, Two Stage Momentary	None (Solderable) IP 43
FM1 ... F1						
FM1 SU1 F1	51.602	<input type="checkbox"/>	SPDT-SB	5A/250V AC	Snap Action, Momentary	20 AWG/3 Cond. IP 43
FM1 SU2 F1	51.608	<input type="checkbox"/>	DPDT-SB	5A/250V AC	Snap Action, Momentary	20 AWG/6 Cond. IP 43
FM1 SU1R F1	51.605	<input type="checkbox"/>	SPDT-SB	5A/250V AC	Snap Action, Maintained	20 AWG/3 Cond. IP 43
FM1 SU2R F1	51.611	<input type="checkbox"/>	DPDT-SB	5A/250V AC	Snap Action, Maintained	20 AWG/6 Cond. IP 43
FM1 SU1DSU1 F1	51.614	<input type="checkbox"/>	2x SPDT-SB	5A/250V AC	Snap Action, Two Stage Momentary	20 AWG/6 Cond. IP 43
FM1 ... F2						
FM1 SU1 F2	51.603	<input type="checkbox"/>	SPDT-SB	5A/250V AC	Snap Action, Momentary	20 AWG/3 Cond. IP 65
FM1 SU2 F2	51.609	<input type="checkbox"/>	DPDT-SB	5A/250V AC	Snap Action, Momentary	20 AWG/6 Cond. IP 65
FM1 SU1R F2	51.606	<input type="checkbox"/>	SPDT-SB	5A/250V AC	Snap Action, Maintained	20 AWG/3 Cond. IP 65
FM1 SU2R F2	51.612	<input type="checkbox"/>	DPDT-SB	5A/250V AC	Snap Action, Maintained	20 AWG/6 Cond. IP 65
FM1 SU1DSU1 F2	51.615	<input type="checkbox"/>	2x SPDT-SB	5A/250V AC	Snap Action, Two Stage Momentary	20 AWG/6 Cond. IP 65

G Gray housing/cable

B Black housing/cable

Options

- Protection Level:
 - IP 67
- Switch Insert:
 - Gold plated contacts for low current applications
 - Electrical Rating: 0.1A/125V AC
 - Silver-Nickel plated contacts
 - Electrical Rating: 10.1A, (1/4HP)/125-250V AC
- Strain Relief:
 - Standard straight-through (IP 68)
 - Bend protection (IP 68)
 - Trumpet Pull/Bend protection (IP 68)
- Cable:
 - Shielded cable
 - Per customer specifications
- Connectors:
 - Per customer specifications
- IEC 60601-1 certified and UL 2601-1 recognized

Dimensions

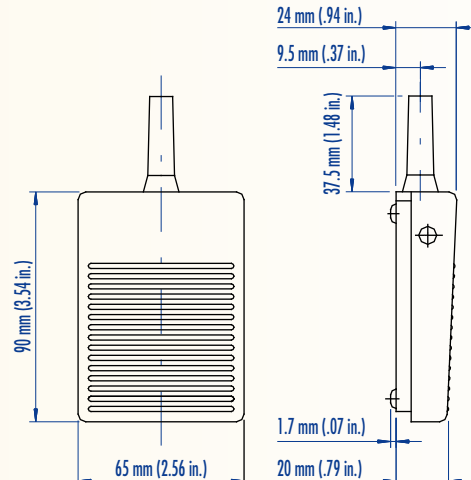

FM1 ... U

- Compact, one pedal foot switch with foot guard

Standard Features

- Housing: Gray or black ABS body and pedal cover
- Guard: Modern design with high quality steel construction and rubber mat, color: bright red
- Protection Level: IP 43 and IP 65
- Switch Insert: Snap action microswitch, UL/CSA approved
 - Electrical Rating: 5A/125-250V AC (If used with appropriate cable, see cable chart on page 29)
 - Contact Types: Momentary, maintained, or two stage momentary
 - Circuit: SPDT-SB, DPDT-SB, 2x SPDT-SB
- Strain Relief: Vinyl sleeve
- Cable:
 - Multi conductor, PVC, SJT, 2 m (6 ft. - 6 in.)
 - Without Cable
- Temperature Range: -20°C up to +80°C (-4°F up to +176°F)



Ordering Information

Type	Catalog No.	Circuit Function	Electrical Ratings	Switch/Contact Type	Cable	Protection Level
FM1 ... L1 U - with Foot Guard						
FM1 SU1 L1 U	51.651	SPDT-SB	5A/250V AC	Snap Action, Momentary	None (Solderable)	IP 43
FM1 SU2 L1 U	51.657	DPDT-SB	5A/250V AC	Snap Action, Momentary	None (Solderable)	IP 43
FM1 SU1R L1 U	51.654	SPDT-SB	5A/250V AC	Snap Action, Maintained	None (Solderable)	IP 43
FM1 SU2R L1 U	51.660	DPDT-SB	5A/250V AC	Snap Action, Maintained	None (Solderable)	IP 43
FM1 SU1DSU1 L1 U	51.663	2x SPDT-SB	5A/250V AC	Snap Action, Two Stage Momentary	None (Solderable)	IP 43
FM1 ... F1 U - with Foot Guard						
FM1 SU1 F1 U	51.652	SPDT-SB	5A/250V AC	Snap Action, Momentary	20 AWG/3 Cond.	IP 43
FM1 SU2 F1 U	51.658	DPDT-SB	5A/250V AC	Snap Action, Momentary	20 AWG/6 Cond.	IP 43
FM1 SU1R F1 U	51.655	SPDT-SB	5A/250V AC	Snap Action, Maintained	20 AWG/3 Cond.	IP 43
FM1 SU2R F1 U	51.661	DPDT-SB	5A/250V AC	Snap Action, Maintained	20 AWG/6 Cond.	IP 43
FM1 SU1DSU1 F1 U	51.664	2x SPDT-SB	5A/250V AC	Snap Action, Two Stage Momentary	20 AWG/6 Cond.	IP 43
FM1 ... F2 U - with Foot Guard						
FM1 SU1 F2 U	51.653	SPDT-SB	5A/250V AC	Snap Action, Momentary	20 AWG/3 Cond.	IP 65
FM1 SU2 F2 U	51.659	DPDT-SB	5A/250V AC	Snap Action, Momentary	20 AWG/6 Cond.	IP 65
FM1 SU1R F2 U	51.656	SPDT-SB	5A/250V AC	Snap Action, Maintained	20 AWG/3 Cond.	IP 65
FM1 SU2R F2 U	51.662	DPDT-SB	5A/250V AC	Snap Action, Maintained	20 AWG/6 Cond.	IP 65
FM1 SU1DSU1 F2 U	51.665	2x SPDT-SB	5A/250V AC	Snap Action, Two Stage Momentary	20 AWG/6 Cond.	IP 65

N Gray foot switch, Red guard

R Black foot switch, Red guard

Options

- Protection Level:
 - IP 67
- Switch Insert:
 - Gold plated contacts for low current applications
 - Electrical Rating: 0.1A/125V AC
 - Silver-Nickel plated contacts
 - Electrical Rating: 10.1A (1/4HP)/125-250V AC
- Strain Relief:
 - Standard straight-through (IP 68)
 - Bend protection (IP 68)
 - Trumpet Pull/Bend protection (IP 68)
- Cable:
 - Shielded cable
 - Per customer specifications
- Connectors:
 - Per customer specifications
- IEC 60601-1 certified and UL 2601-1 recognized
- Custom colors upon request

Dimensions

Note: For foot pedal dimensions, see page 5.



FM2

- Compact, two pedal foot switch

Standard Features

- Housing: Gray or black ABS body and pedal cover
- Protection Level: IP 43 and IP 65
- Switch Insert: Snap action microswitch, UL/CSA approved
 - Electrical Rating: 5A/125-250V AC (If used with appropriate cable, see cable chart on page 29)
 - Contact Types: Momentary, maintained, or two stage momentary
 - Circuit: SPDT-SB, DPDT-SB, 2x SPDT-SB
- Strain Relief: Vinyl sleeve
- Cable:
 - Multi conductor, PVC, SJT, 2 m (6 ft. - 6 in.)
 - Without Cable
- Temperature Range: -20°C up to +80°C (-4°F up to +176°F)



Ordering Information

Type	Catalog No.	Circuit Function	Electrical Ratings	Switch/Contact Type	Cable	Protection Level
FM2 ... L1						
FM2 SU1(2x) L1	51.701	SPDT-SB	5A/250V AC	Snap Action, Momentary	None (Solderable)	IP 43
FM2 SU2(2x) L1	51.711	DPDT-SB	5A/250V AC	Snap Action, Momentary	None (Solderable)	IP 43
FM2 SU1R(2x) L1	51.706	SPDT-SB	5A/250V AC	Snap Action, Maintained	None (Solderable)	IP 43
FM2 SU2R(2x) L1	51.716	DPDT-SB	5A/250V AC	Snap Action, Maintained	None (Solderable)	IP 43
FM2 SU1DSU1(2x) L1	51.721	2x SPDT-SB	5A/250V AC	Snap Action, Two Stage Momentary	None (Solderable)	IP 43
FM2 ... K1						
FM2 SU1(2x) K1	51.702	SPDT-SB	5A/250V AC	Snap Action, Momentary	None (Terminals)	IP 43
FM2 SU2(2x) K1	51.712	DPDT-SB	5A/250V AC	Snap Action, Momentary	None (Terminals)	IP 43
FM2 SU1R(2x) K1	51.707	SPDT-SB	5A/250V AC	Snap Action, Maintained	None (Terminals)	IP 43
FM2 SU2R(2x) K1	51.717	DPDT-SB	5A/250V AC	Snap Action, Maintained	None (Terminals)	IP 43
FM2 SU1DSU1(2x) K1	51.722	2x SPDT-SB	5A/250V AC	Snap Action, Two Stage Momentary	None (Terminals)	IP 43
FM2 ... F1						
FM2 SU1(2x) F1	51.704	SPDT-SB	5A/250V AC	Snap Action, Momentary	20 AWG/ 6 Cond.	IP 43
FM2 SU2(2x) F1	51.714	DPDT-SB	5A/250V AC	Snap Action, Momentary	20 AWG/12 Cond.	IP 43
FM2 SU1R(2x) F1	51.709	SPDT-SB	5A/250V AC	Snap Action, Maintained	20 AWG/ 6 Cond.	IP 43
FM2 SU2R(2x) F1	51.718	DPDT-SB	5A/250V AC	Snap Action, Maintained	20 AWG/12 Cond.	IP 43
FM2 SU1DSU1(2x) F1	51.724	2x SPDT-SB	5A/250V AC	Snap Action, Two Stage Momentary	20 AWG/12 Cond.	IP 43
FM2 ... K2						
FM2 SU1(2x) K2	51.703	SPDT-SB	5A/250V AC	Snap Action, Momentary	None (Terminals)	IP 65
FM2 SU2(2x) K2	51.713	DPDT-SB	5A/250V AC	Snap Action, Momentary	None (Terminals)	IP 65
FM2 SU1R(2x) K2	51.708	SPDT-SB	5A/250V AC	Snap Action, Maintained	None (Terminals)	IP 65
FM2 SU2R(2x) K2	51.718	DPDT-SB	5A/250V AC	Snap Action, Maintained	None (Terminals)	IP 65
FM2 SU1DSU1(2x) K2	51.723	2x SPDT-SB	5A/250V AC	Snap Action, Two Stage Momentary	None (Terminals)	IP 65
FM2 ... F2						
FM2 SU1(2x) F2	51.705	SPDT-SB	5A/250V AC	Snap Action, Momentary	20 AWG/ 6 Cond.	IP 65
FM2 SU2(2x) F2	51.715	DPDT-SB	5A/250V AC	Snap Action, Momentary	20 AWG/12 Cond.	IP 65
FM2 SU1R(2x) F2	51.710	SPDT-SB	5A/250V AC	Snap Action, Maintained	20 AWG/ 6 Cond.	IP 65
FM2 SU2R(2x) F2	51.720	DPDT-SB	5A/250V AC	Snap Action, Maintained	20 AWG/12 Cond.	IP 65
FM2 SU1DSU1(2x) F2	51.725	2x SPDT-SB	5A/250V AC	Snap Action, Two Stage Momentary	20 AWG/12 Cond.	IP 65

- G Gray housing/cable
- B Black housing/cable

Options

- Protection Level: - IP 67
- Switch Insert:
 - Gold plated contacts for low current applications
 - Electrical Rating: 0.1A/125V AC
 - Silver-Nickel plated contacts
 - Electrical Rating: 10.1A (1/4HP)/125-250V AC
- Strain Relief:
 - Standard straight-through (IP 68)
 - Bend protection (IP 68)
 - Trumpet Pull/Bend protection (IP 68)
- Cable:
 - Shielded cable
 - Per customer specifications
- Connectors:
 - Per customer specifications
- IEC 60601-1 certified and UL 2601-1 recognized
- Aluminum base plate with rubber mat
- Different switch inserts for each pedal

Dimensions

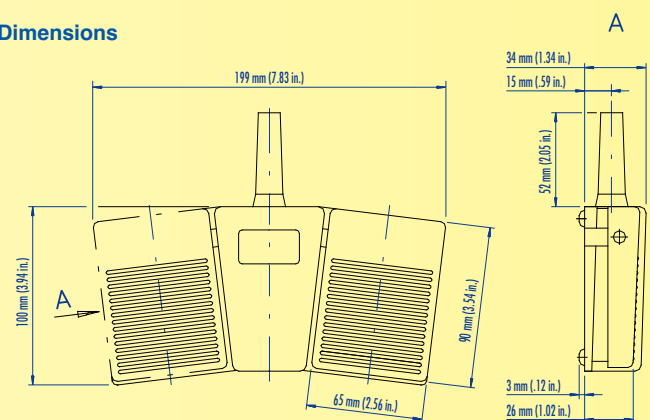

FM3

- Compact, three pedal foot switch

Standard Features

- Housing: Gray or black ABS body and pedal cover
- Base Plate: Die Cast Aluminum, PVC Conduit
- Protection Level: IP 43 and IP 65
- Switch Insert: Snap action microswitch, UL/CSA approved
 - Electrical Rating: 5A/ 125-250V AC (If used with appropriate cable, see cable chart on page 29)
 - Contact Types: Momentary, maintained, or two stage momentary
 - Circuit: SPDT-SB, DPDT-SB, 2x SPDT-SB
- Strain Relief: Vinyl sleeve
- Cable:
 - Multi conductor, PVC, SJT, 2 m (6 ft. - 6 in.)
 - Without Cable
- Temperature Range: -20°C up to +80°C (-4°F up to +176°F)



Ordering Information

Type	Catalog No.	Circuit Function	Electrical Ratings	Switch/Contact Type	Cable	Protection Level
FM3 ... L1						
FM3 SU1 (3x) L1	51.801	SPDT-SB	5A/250V AC	Snap Action, Momentary	None (Solderable)	IP 43
FM3 SU2 (3x) L1	51.811	DPDT-SB	5A/250V AC	Snap Action, Momentary	None (Solderable)	IP 43
FM3 SU1R (3x) L1	51.806	SPDT-SB	5A/250V AC	Snap Action, Maintained	None (Solderable)	IP 43
FM3 SU2R (3x) L1	51.816	DPDT-SB	5A/250V AC	Snap Action, Maintained	None (Solderable)	IP 43
FM3 SU1DSU1 (3x) L1	51.821	2x SPDT-SB	5A/250V AC	Snap Action, Two Stage Momentary	None (Solderable)	IP 43
FM3 ... K1						
FM3 SU1 (3x) K1	51.802	SPDT-SB	5A/250V AC	Snap Action, Momentary	None (Terminals)	IP 43
FM3 SU2 (3x) K1	51.812	DPDT-SB	5A/250V AC	Snap Action, Momentary	None (Terminals)	IP 43
FM3 SU1R (3x) K1	51.807	SPDT-SB	5A/250V AC	Snap Action, Maintained	None (Terminals)	IP 43
FM3 SU2R (3x) K1	51.817	DPDT-SB	5A/250V AC	Snap Action, Maintained	None (Terminals)	IP 43
FM3 SU1DSU1 (3x) K1	51.822	2x SPDT-SB	5A/250V AC	Snap Action, Two Stage Momentary	None (Terminals)	IP 43
FM3 ... F1						
FM3 SU1 (3x) F1	51.804	SPDT-SB	5A/250V AC	Snap Action, Momentary	20 AWG/ 9 Cond.	IP 43
FM3 SU2 (3x) F1	51.814	DPDT-SB	5A/250V AC	Snap Action, Momentary	22 AWG/18 Cond.	IP 43
FM3 SU1R (3x) F1	51.809	SPDT-SB	5A/250V AC	Snap Action, Maintained	20 AWG/ 9 Cond.	IP 43
FM3 SU2R (3x) F1	51.819	DPDT-SB	5A/250V AC	Snap Action, Maintained	22 AWG/18 Cond.	IP 43
FM3 SU1DSU1 (3x) F1	51.824	2x SPDT-SB	5A/250V AC	Snap Action, Two Stage Momentary	22 AWG/18 Cond.	IP 43
FM3 ... K2						
FM3 SU1 (3x) K2	51.803	SPDT-SB	5A/250V AC	Snap Action, Momentary	None (Terminals)	IP 65
FM3 SU2 (3x) K2	51.813	DPDT-SB	5A/250V AC	Snap Action, Momentary	None (Terminals)	IP 65
FM3 SU1R (3x) K2	51.808	SPDT-SB	5A/250V AC	Snap Action, Maintained	None (Terminals)	IP 65
FM3 SU2R (3x) K2	51.818	DPDT-SB	5A/250V AC	Snap Action, Maintained	None (Terminals)	IP 65
FM3 SU1DSU1 (3x) K2	51.823	2x SPDT-SB	5A/250V AC	Snap Action, Two Stage Momentary	None (Terminals)	IP 65
FM3 ... F2						
FM3 SU1 (3x) F2	51.805	SPDT-SB	5A/250V AC	Snap Action, Momentary	20 AWG/ 9 Cond.	IP 65
FM3 SU2 (3x) F2	51.815	DPDT-SB	5A/250V AC	Snap Action, Momentary	22 AWG/18 Cond.	IP 65
FM3 SU1R (3x) F2	51.810	SPDT-SB	5A/250V AC	Snap Action, Maintained	20 AWG/ 9 Cond.	IP 65
FM3 SU2R (3x) F2	51.820	DPDT-SB	5A/250V AC	Snap Action, Maintained	22 AWG/18 Cond.	IP 65
FM3 SU1DSU1 (3x) F2	51.825	2x SPDT-SB	5A/250V AC	Snap Action, Two Stage Momentary	22 AWG/18 Cond.	IP 65

G Gray housing/cable

B Black housing/cable

Options

- Protection Level:
 - IP 67
- Switch Insert:
 - Gold plated contacts for low current applications
 - Electrical Rating: 0.1A/125V AC
 - Silver-Nickel plated contacts
 - Electrical Rating: 10.1A (1/4HP)/125-250V AC
- Strain Relief:
 - Standard straight-through (IP 68)
 - Bend protection (IP 68)
 - Trumpet Pull/Bend protection (IP 68)
- Cable:
 - Shielded cable
 - Per customer specifications
- Connectors:
 - Per customer specifications
- IEC 60601-1 certified and UL 2601-1 recognized
- Different switch inserts for each pedal
- Also available with four or more pedals

Dimensions



ALTECH CORP®, 35 ROYAL ROAD, FLEMINGTON, NJ 08822-6000 • 908.806.9400

FM3 - Ergonomic

- Compact, three pedal foot switch

Standard Features

- Housing: Gray or black ABS body and pedal cover
- Base Plate: Die Cast Aluminum with rubber mat
- Protection Level: IP 43 and IP 65
- Switch Insert: Snap action microswitch, UL/CSA approved
 - Electrical Rating: 5A/125-250V AC (If used with appropriate cable, see cable chart on page 29)
 - Contact Types: Momentary, maintained, or two stage momentary
 - Circuit: SPDT-SB, DPDT-SB, 2x SPDT-SB
- Strain Relief: Vinyl sleeve
- Cable: - Multi conductor, PVC, SJT, 2 m (6 ft. - 6 in.)
- Temperature Range: -20°C up to +80°C (-4°F up to +176°F)



Ordering Information

Type	Catalog No.	Circuit Function	Electrical Ratings	Switch/Contact Type	Cable	Protection Level
FM3 ... F1						
FM3 SU1 (3x) F1	51.864 <input type="checkbox"/>	SPDT-SB	5A/250V AC	Snap Action, Momentary	20 AWG/ 9 Cond.	IP 43
FM3 SU2 (3x) F1	51.874 <input type="checkbox"/>	DPDT-SB	5A/250V AC	Snap Action, Momentary	22 AWG/18 Cond.	IP 43
FM3 SU1R (3x) F1	51.869 <input type="checkbox"/>	SPDT-SB	5A/250V AC	Snap Action, Maintained	20 AWG/ 9 Cond.	IP 43
FM3 SU2R (3x) F1	51.879 <input type="checkbox"/>	DPDT-SB	5A/250V AC	Snap Action, Maintained	22 AWG/18 Cond.	IP 43
FM3 SU1DSU1 (3x) F1	51.884 <input type="checkbox"/>	2x SPDT-SB	5A/250V AC	Snap Action, Two Stage Momentary	22 AWG/18 Cond.	IP 43
FM3 ... F2						
FM3 SU1 (3x) F2	51.865 <input type="checkbox"/>	SPDT-SB	5A/250V AC	Snap Action, Momentary	20 AWG/ 9 Cond.	IP 65
FM3 SU2 (3x) F2	51.875 <input type="checkbox"/>	DPDT-SB	5A/250V AC	Snap Action, Momentary	22 AWG/18 Cond.	IP 65
FM3 SU1R (3x) F2	51.870 <input type="checkbox"/>	SPDT-SB	5A/250V AC	Snap Action, Maintained	20 AWG/ 9 Cond.	IP 65
FM3 SU2R (3x) F2	51.880 <input type="checkbox"/>	DPDT-SB	5A/250V AC	Snap Action, Maintained	22 AWG/18 Cond.	IP 65
FM3 SU1DSU1 (3x) F2	51.885 <input type="checkbox"/>	2x SPDT-SB	5A/250V AC	Snap Action, Two Stage Momentary	22 AWG/18 Cond.	IP 65

- G Gray housing/cable
- B Black housing/cable

Options

- Protection Level: - IP 67
- Switch Insert: - Gold plated contacts for low current applications
 - Electrical Rating: 0.1A/125V AC
 - Silver-Nickel plated contacts
 - Electrical Rating: 10.1A (1/4HP)/125-250V AC
- Strain Relief: - Standard straight-through (IP 68)
 - Bend protection (IP 68)
 - Trumpet Pull/Bend protection (IP 68)
- Cable: - Shielded cable
 - Per customer specifications
- Connectors: - Per customer specifications
- IEC 60601-1 certified and UL 2601-1 recognized
- Different switch inserts for each pedal

Dimensions



PCFS-3M SERIES



Altech's new low cost foot switch is ideal for any light to medium duty application. The PCFS-3M has an electrical rating of 10A (1/2HP)/125V AC, it can serve as a foot operated on/off switch for a wide range of motor driven and electrical devices.

Characteristics:

The virtually indestructible steel housing meets even more challenging demands of every day applications. The steel guard comes standard in red or orange and provides an affordable "safeguarding" of the foot switch. The guard is interchangeable with the FM1 series foot switch which makes this configuration a perfect fit for more cost sensitive applications.

Application Examples:

- Operation of logic signals
- Coil winding machines
- Photo lab equipment
- Sewing machines
- Packaging equipment
- Conveyor belts
- Imprinting equipment
- CNC machines

Warning

Please see page 25 in reference to the warning that applies to every application.



PCFS-3M



- Compact, one pedal foot switch with and without guard

Standard Features

- Housing: Black steel body and pedal cover
- Guard: Modern design with high quality steel construction and rubber mat, color: bright red or orange
- Protection Level: IP 20
- Switch Insert: Snap action microswitch, UL/CSA approved
Electrical Rating: 10A (1/2HP)/125V AC (If used with appropriate cable, see cable chart on page 29)
Contact Types: Momentary
Circuit: SPDT-SB or 1n.o.
- Strain Relief: Built-in
- Cable: - Without Cable
- Multi conductor, SJOOW
- Temperature Range: -20°C up to +80°C (-4°F up to +176°F)



51.001B



51.051OR



51.051R



Ordering Information

Catalog No.	Circuit Function	Electrical Rating	Guard Color	Cable Length (Size)	Screw Terminal	Quick Connect	Protection Level
PCFS-3M (No Cable)							
51.001B	SPDT-SB	10A(1/2HP)/125V AC	None	None (Terminals)	X		IP 20
51.002B	SPDT-SB	10A(1/2HP)/125V AC	None	None (Terminals)		X	IP 20
PCFS-3MU (with guard)							
51.051R	SPDT-SB	10A(1/2HP)/125V AC	Red	None (Terminals)	X		IP 20
51.052R	SPDT-SB	10A(1/2HP)/125V AC	Red	None (Terminals)		X	IP 20
51.051OR	SPDT-SB	10A(1/2HP)/125V AC	Orange	None (Terminals)	X		IP 20
51.052OR	SPDT-SB	10A(1/2HP)/125V AC	Orange	None (Terminals)		X	IP 20
PCFS-3M with cable (3 Conductor)							
51.012B	1n.o.	10A(1/2HP)/125V AC	None	2m/6.6ft (18AWG)	X		IP 20
51.013B	1n.o.	10A(1/2HP)/125V AC	None	2m/6.6ft (18AWG)		X	IP 20
51.015B	1n.o.	10A(1/2HP)/125V AC	None	5m/16.4ft (18AWG)	X		IP 20
51.016B	1n.o.	10A(1/2HP)/125V AC	None	5m/16.4ft (18AWG)		X	IP 20
PCFS-3MU (with guard)							
51.062R	1n.o.	10A(1/2HP)/125V AC	Red	2m/6.6ft (18AWG)	X		IP 20
51.063R	1n.o.	10A(1/2HP)/125V AC	Red	2m/6.6ft (18AWG)		X	IP 20
51.065R	1n.o.	10A(1/2HP)/125V AC	Red	5m/16.4ft (18AWG)	X		IP 20
51.066R	1n.o.	10A(1/2HP)/125V AC	Red	5m/16.4ft (18AWG)		X	IP 20
51.062OR	1n.o.	10A(1/2HP)/125V AC	Orange	2m/6.6ft (18AWG)	X		IP 20
51.063OR	1n.o.	10A(1/2HP)/125V AC	Orange	2m/6.6ft (18AWG)		X	IP 20
51.065OR	1n.o.	10A(1/2HP)/125V AC	Orange	5m/16.4ft (18AWG)	X		IP 20
51.066OR	1n.o.	10A(1/2HP)/125V AC	Orange	5m/16.4ft (18AWG)		X	IP 20
PCFS-3M with cable (4 Conductor)							
51.022B	SPDT-SB	10A(1/2HP)/125V AC	None	2m/6.6ft (18AWG)	X		IP 20
51.023B	SPDT-SB	10A(1/2HP)/125V AC	None	2m/6.6ft (18AWG)		X	IP 20
51.025B	SPDT-SB	10A(1/2HP)/125V AC	None	5m/16.4ft (18AWG)	X		IP 20
51.026B	SPDT-SB	10A(1/2HP)/125V AC	None	5m/16.4ft (18AWG)		X	IP 20
PCFS-3MU (with guard)							
51.072R	SPDT-SB	10A(1/2HP)/125V AC	Red	2m/6.6ft (18AWG)	X		IP 20
51.073R	SPDT-SB	10A(1/2HP)/125V AC	Red	2m/6.6ft (18AWG)		X	IP 20
51.075R	SPDT-SB	10A(1/2HP)/125V AC	Red	5m/16.4ft (18AWG)	X		IP 20
51.076R	SPDT-SB	10A(1/2HP)/125V AC	Red	5m/16.4ft (18AWG)		X	IP 20
51.072OR	SPDT-SB	10A(1/2HP)/125V AC	Orange	2m/6.6ft (18AWG)	X		IP 20
51.073OR	SPDT-SB	10A(1/2HP)/125V AC	Orange	2m/6.6ft (18AWG)		X	IP 20
51.075OR	SPDT-SB	10A(1/2HP)/125V AC	Orange	5m/16.4ft (18AWG)	X		IP 20
51.076OR	SPDT-SB	10A(1/2HP)/125V AC	Orange	5m/16.4ft (18AWG)		X	IP 20

Options

- Color of guard
- Cable: - Shielded cable
- Per customer specifications
- Connectors: - Per customer specifications

Dimensions



Guard

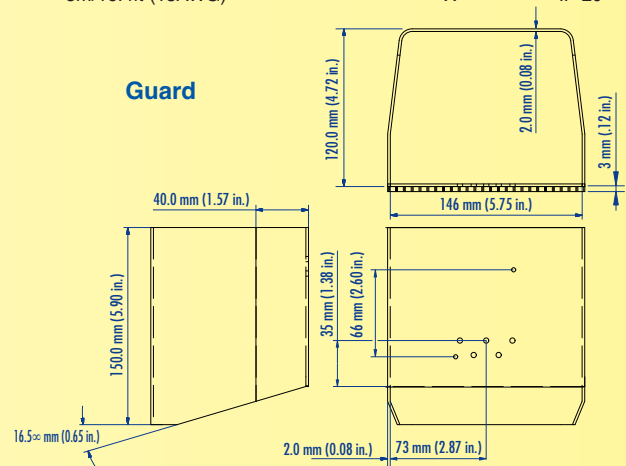

FK SERIES



The FK series foot switches are suitable for light and medium duty applications. The medium size, sturdy ABS housing fits up to 3 snap action microswitches rated up to 10A (1/2HP)/250V AC. The momentary and two stage momentary contact types cover almost every demand.

With the optional strain reliefs, cables and connectors and the larger pedal, the FK series is a low cost alternative, where no high protection levels are required. This series covers the range between the FM series and the FS series. This foot switch will fit numerous applications, including the following:

- Medical equipment (tablet sorter, labeling machines etc.)
- Dictation machines
- Photo laboratory equipment
- Medium industrial machines (storage and retrieval systems, sewing and textile machines, etc.)

 **Warning**

Please see page 25 in reference to the warning that applies to every application.



FK1

- Medium size, one pedal foot switch

Standard Features

- Housing: Gray or black ABS body and pedal cover
- Protection Level: IP 43
- Switch Insert: Snap action microswitch, UL/CSA approved
Electrical Rating: 10A (1/2HP)/125-250V AC (If used with appropriate cable, see cable chart on page 29)
Contact Types: Momentary, two stage momentary
Circuit: SPDT-SB, DPDT-SB, 2x SPDT-SB
- Strain Relief: Vinyl sleeve
- Cable: - Multi conductor, PVC, SJT, 2 m (6 ft. - 6 in.)
- Without Cable
- Temperature Range: -20°C up to +80°C (-4°F up to +176°F)



DIN



Ordering Information

Type Protection	Catalog No.	Circuit	Electrical	Switch/Contact	Cable	Level
FK1 ... L		Function	Ratings	Type		
FK1 SU1 L	51.901 <input type="checkbox"/>	SPDT-SB	10A (1/2HP)/250V AC	Snap Action, Momentary	None (Solderable)	IP 43
FK1 SU2 L	51.904 <input type="checkbox"/>	DPDT-SB	10A (1/2HP)/250V AC	Snap Action, Momentary	None (Solderable)	IP 43
FK1 SU1DSU1 L	51.907 <input type="checkbox"/>	2x SPDT-SB	10A (1/2HP)/250V AC	Snap Action, Two Stage Momentary	None (Solderable)	IP 43
FK1 ... K						
FK1 SU1 K	51.902 <input type="checkbox"/>	SPDT-SB	10A (1/2HP)/250V AC	Snap Action, Momentary	None (Terminals)	IP 43
FK1 SU2 K	51.905 <input type="checkbox"/>	DPDT-SB	10A (1/2HP)/250V AC	Snap Action, Momentary	None (Terminals)	IP 43
FK1 SU1DSU1 K	51.908 <input type="checkbox"/>	2x SPDT-SB	10A (1/2HP)/250V AC	Snap Action, Two Stage Momentary	None (Terminals)	IP 43
FK1 ... F						
FK1 SU1 F	51.903 <input type="checkbox"/>	SPDT-SB	10A (1/2HP)/250V AC	Snap Action, Momentary	18 AWG/3 Cond.	IP 43
FK1 SU1R F	51.906 <input type="checkbox"/>	DPDT-SB	10A (1/2HP)/250V AC	Snap Action, Momentary	18 AWG/6 Cond.	IP 43
FK1 SU1DSU1 F	51.909 <input type="checkbox"/>	2x SPDT-SB	10A (1/2HP)/250V AC	Snap Action, Two Stage Momentary	18 AWG/6 Cond.	IP 43

Gray housing/cable

Black housing/cable

Options

- 3 Switch Inserts available upon request
- Strain Relief:
 - Second vinyl sleeve
 - Standard straight-through (IP 68)
 - Bend protection (IP 68)
 - Trumpet Pull/Bend Protection (IP 68)
- Cable:
 - Shielded cable
 - Per customer specifications
- Connectors:
 - Per customer specifications
- Foot Guard also available

Dimensions



FL SERIES



The FL series foot switches are appropriate for heavy duty applications in hazardous and demanding environments. The foot switch with the Polyamide 6.6 housing shows the same sturdy body as the FS series, but with the advantage of resistance against water, oil, and certain acids and chemicals, which enables a longer life expectancy. The foot guard consists of die cast aluminum, to sustain all safety requirements.

The FL series offers considerable flexibility with the combination of slow make-break and snap action switch inserts, with the contact types momentary, maintained and two stage momentary and the choice of different potentiometer values. Human safety and machine protection can be provided by adding of Anti-Trip lever and foot guard. These items prevent the foot switch from accidentally actuating the machine function. Different strain reliefs, cables, connectors and custom colors are also available.

The main applications of this non-corrosive foot switch are “wet” industrial environments, drilling processes, and in the food industry, where the environment has to be cleaned regularly with cleaning detergent.

Warning

Please see page 25 in reference to the warning that applies to every application.



FL1

- Light medium size, one pedal foot switch

Standard Features

- Housing: Polyamide 6.6 body, cover and pedal
Colors: Gray body, red cover and black pedal
Anti-Trip: Die cast aluminum pedal and lever in gray (available on some models)
- Protection Level: IP 65
- Switch Insert: Snap action or slow make-break
Silver alloy contact material
Electrical Rating: 10A/500V AC (If used with appropriate cable, see cable chart on page 29)
Contact Types: Momentary, maintained, or two stage momentary
Circuit: SPDT-SB; DPDT-DB; 10k Ohm, 2.0W
Potentiometer with SPDT-SB microswitch
- Cable Entry: Threaded hole (M20)
- Temperature Range: -30°C up to +80°C (-22°F up to +176°F)



Ordering Information

Type	Catalog No.	Circuit Function	Electrical Ratings	Switch/Contact Type	Anti-Trip	Cable Screw Terminals	Protection Level
FL1							
FL1 U1	51.401	SPDT-DB	10A/500V AC	Slow make-break, Momentary		X	IP 65
FL1 U1R	51.402	SPDT-DB	10A/500V AC	Slow make-break, Maintained		X	IP 65
FL1 U1S	51.403	SPDT-DB	10A/500V AC	Slow make-break, Momentary	X	X	IP 65
FL1 U1RS	51.404	SPDT-DB	10A/500V AC	Slow make-break, Maintained	X	X	IP 65
FL1 SU1	51.405	SPDT-DB	10A/500V AC	Snap Action, Momentary		X	IP 65
FL1 SU1R	51.406	SPDT-DB	10A/500V AC	Snap Action, Maintained		X	IP 65
FL1 SU1S	51.407	SPDT-DB	10A/500V AC	Snap Action, Momentary	X	X	IP 65
FL1 SU1RS	51.408	SPDT-DB	10A/500V AC	Snap Action, Maintained	X	X	IP 65
FL1 U2	51.409	DPDT-DB	10A/500V AC	Slow make-break, Momentary*		X	IP 65
FL1 U1DU1	51.410	2x SPDT-DB	10A/500V AC	Slow make-break, Two Stage Momentary		X	IP 65
FL1 U2S	51.411	DPDT-DB	10A/500V AC	Slow make-break, Momentary*	X	X	IP 65
FL1 U1DU1S	51.412	2x SPDT-DB	10A/500V AC	Slow make-break, Two Stage Momentary	X	X	IP 65
FL1 SU2	51.413	DPDT-DB	10A/500V AC	Snap Action, Momentary*		X	IP 65
FL1 SU1DSU1	51.414	2x SPDT-DB	10A/500V AC	Snap Action, Two Stage Momentary		X	IP 65
FL1 SU2S	51.415	DPDT-DB	10A/500V AC	Snap Action, Momentary*	X	X	IP 65
FL1 SU1DSU1S	51.416	2x SPDT-DB	10A/500V AC	Snap Action, Two Stage Momentary	X	X	IP 65
FL1 SU1P10 L	51.417	10k Ohm, 2.0W Potentiometer with SPDT-SB Microswitch (5A/250V AC)				Solder Tabs	IP 65

[R] Gray body, red cover and black (Anti-Trip: gray) pedal

Options

- Switch Insert:
 - Gold plated contacts for low current applications
 - Electrical Rating: Max. Power Consumption: 12.5mW at max. 25mA or max. 25V DC
- Strain Relief:
 - Standard straight-through (IP 68)
 - Bend protection (IP 68)
 - Trumpet Pull/Bend protection (IP 68)
- Cable:
 - Multi conductor, PVC, SJT
 - Multi conductor, PVC, SJT, shielded
 - Per customer specifications
- Connectors:
 - Per customer specifications
- IEC 601-1 certified
- Other potentiometer values available upon request
- Custom colors available upon request
- Foot rest also available

Dimensions



* Maintained contacts available upon request

FL1 ... U

- Light medium size, one pedal foot switch with guard

Standard Features

- Housing: Polyamide 6.6 body and pedal
- Guard: Die cast aluminum
 - Colors: Gray body, red guard and black pedal
 - Anti-Trip: Die cast aluminum pedal and lever in gray (available on some models)
- Protection Level: IP 65
- Switch Insert: Snap action or slow make-break
 - Silver alloy contact material
 - Electrical Rating: 10A/500V AC (If used with appropriate cable, see cable chart on page 29)
 - Contact Types: Momentary, maintained, or two stage momentary
 - Circuit: SPDT-DB; DPDT-DB; 10k Ohm, 2.0W Potentiometer with SPDT-SB microswitch
- Cable Entry: Threaded hole (M20)
- Temperature Range: -30°C up to +80°C (-22°F up to +176°F)



DIN



Ordering Information

Type	Catalog No.	Circuit Function	Electrical Ratings	Switch/Contact Type	Anti-Trip	Cable Screw Terminals	Protection Level
FL1 ... U - with Foot Guard							
FL1 U1 U	51.451	SPDT-DB	10A/500V AC	Slow make-break, Momentary		X	IP 65
FL1 U1R U	51.452	SPDT-DB	10A/500V AC	Slow make-break, Maintained		X	IP 65
FL1 U1S U	51.453	SPDT-DB	10A/500V AC	Slow make-break, Momentary	X	X	IP 65
FL1 U1RS U	51.454	SPDT-DB	10A/500V AC	Slow make-break, Maintained	X	X	IP 65
FL1 SU1 U	51.455	SPDT-DB	10A/500V AC	Snap Action, Momentary		X	IP 65
FL1 SU1R U	51.456	SPDT-DB	10A/500V AC	Snap Action, Maintained		X	IP 65
FL1 SU1S U	51.457	SPDT-DB	10A/500V AC	Snap Action, Momentary	X	X	IP 65
FL1 SU1RS U	51.458	SPDT-DB	10A/500V AC	Snap Action, Maintained	X	X	IP 65
FL1 U2 U	51.459	DPDT-DB	10A/500V AC	Slow make-break, Momentary*		X	IP 65
FL1 U1DU1 U	51.460	2x SPDT-DB	10A/500V AC	Slow make-break, Two Stage Momentary		X	IP 65
FL1 U2S U	51.461	DPDT-DB	10A/500V AC	Slow make-break, Momentary*	X	X	IP 65
FL1 U1DU1S U	51.462	2x SPDT-DB	10A/500V AC	Slow make-break, Two Stage Momentary	X	X	IP 65
FL1 SU2 U	51.463	DPDT-DB	10A/500V AC	Snap Action, Momentary*		X	IP 65
FL1 SU1DSU1 U	51.464	2x SPDT-DB	10A/500V AC	Snap Action, Two Stage Momentary		X	IP 65
FL1 SU2S U	51.465	DPDT-DB	10A/500V AC	Snap Action, Momentary*	X	X	IP 65
FL1 SU1DSU1S U	51.466	2x SPDT-DB	10A/500V AC	Snap Action, Two Stage Momentary	X	X	IP 65
FL1 SU1P10 L U	51.467	10k Ohm, 2.0W Potentiometer with SPDT-SB Microswitch (5A/250V AC)				Solder Tabs	IP 65

[R] Gray body, red cover and black (Anti-Trip: gray) pedal

Options

- Switch Insert:
 - Gold plated contacts for low current applications
 - Electrical Rating: Max. Power Consumption: 12.5mW at max. 25mA or max. 25V DC
- Strain Relief:
 - Standard straight-through (IP 68)
 - Bend protection (IP 68)
 - Trumpet Pull/Bend protection (IP 68)
- Cable:
 - Multi conductor, PVC, SJT
 - Multi conductor, PVC, SJT, shielded
 - Per customer specifications
- Connectors:
 - Per customer specifications
- IEC 601-1 certified
- Other potentiometer values available upon request
- Custom colors available upon request
- Foot rest also available

Dimensions

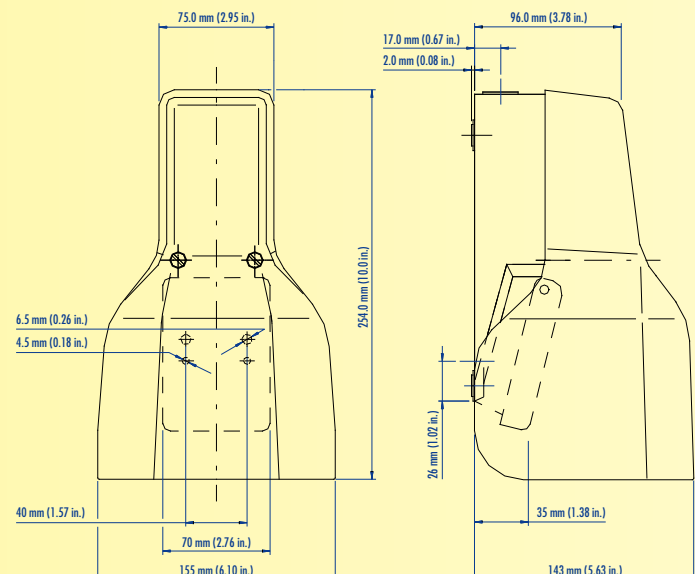

* Maintained contacts available upon request

ALTECH CORP®, 35 ROYAL ROAD, FLEMINGTON, NJ 08822-6000 • 908.806.9400

Altech Custom Designs



Foot switches for medical applications require unique designs for safety, reliability and hygiene. Almost every foot switch is a custom product. Altech is a leader in designing these medical foot switches that combine the unique requirements needed for these demanding applications. Altech's design department has designed foot switches to meet a doctor's preferences such as an actuation force from 0.5 lbs. to 50 lbs. Sometimes it is as simple as a cable length change, a totally different cable, or a special connector. Here are some of the existing designs:

- FM1 was molded using a special white ABS material
- FM2 required an aluminum base plate with blue and yellow pedal covers
- FM3 is ergonomically designed for an ENT doctor
- FS3+1 was mounted on an aluminum plate, which connects to an FS1 with 1 cable exit

The foot switch on the right shows an innovative concept created by our design department. This takes the foot switch to a totally different level incorporating new ideas and blending them into modern equipment designs.

Altech Corp can design and manufacture a foot switch to meet needs. Give us an opportunity to quote on your requirements!

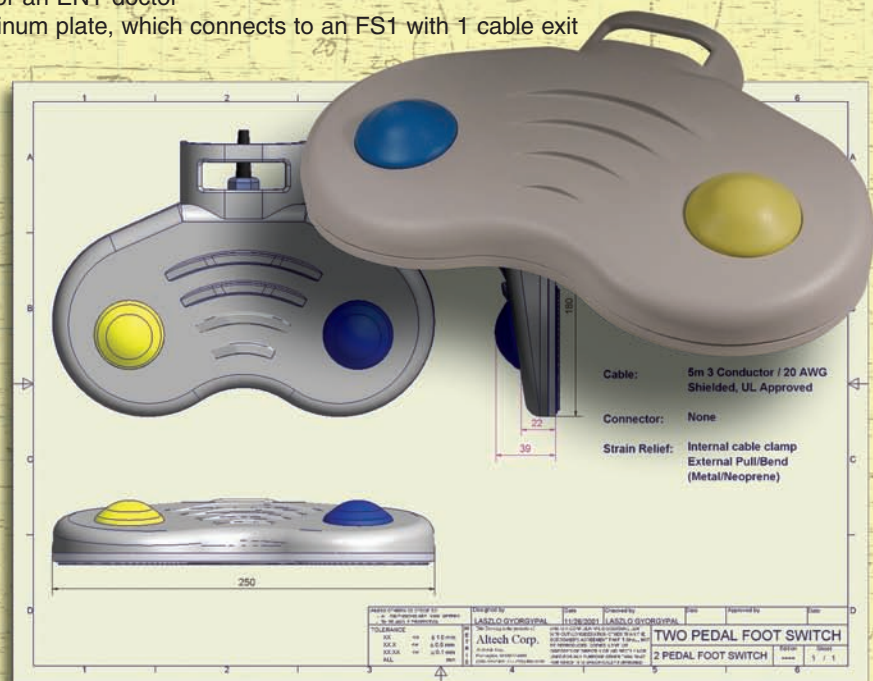

FS SERIES



The heavy duty, medium size FS series foot switches are primarily used in industrial and medical applications. Due to the sturdy design of the die cast aluminum housing, the foot switch is an exceptional value for strict environments. This compact design offers a lot of versatility:

- Every combination of slow make-break and snap action switch inserts with momentary, maintained and two stage momentary contact types are possible. Different potentiometer values are also available.
- Additional safety features like a foot guard, Anti-Trip lever and especially two safety foot switch versions complete this line.
- The optional medical versions and explosion protected foot switches meet the requirements of either IEC 601-1 or EEX d ||C T6, and come with appropriate strain relief and 3 meter (10 ft.) cable.
- The foot switch can be customized with a wide range of options, including cables, connectors, colors, and foot rests.

The typical industrial applications include:

- ironing machines
- construction machinery
- sand blasting machines
- bending machines
- machine tools
- medical equipment



Warning

Please see page 25 in reference to the warning that applies to every application.

FS1

- Heavy duty medium size, one pedal foot switch

Standard Features

- Housing: Die cast aluminum body and cover with Polyamide 6.6 pedal
Colors: Gray body, red cover and black pedal
Anti-Trip: Die cast aluminum pedal and lever in gray (available on some models)
- Protection Level: IP 65
- Switch Insert: Snap action or slow make-break
Silver alloy contact material
Electrical Rating: 10A/500V AC (If used with appropriate cable, see cable chart on page 29)
Contact Types: Momentary, maintained, or two stage momentary
Circuit: SPDT-DB; DPDT-DB; 10k Ohm, 2.0W Potentiometer with SPDT-SB microswitch
- Cable Entry: Threaded hole (M20)
- Temperature Range: -30°C up to +80°C (-22°F up to +176°F)



Ordering Information

Type	Catalog No.	Circuit Function	Electrical Ratings	Switch/Contact Type	Anti-Trip	Cable Screw Terminals	Protection Level
FS1							
FS1 U1	51.101	SPDT-DB	10A/500V AC	Slow make-break, Momentary		X	IP 65
FS1 U1R	51.102	SPDT-DB	10A/500V AC	Slow make-break, Maintained		X	IP 65
FS1 U1S	51.103	SPDT-DB	10A/500V AC	Slow make-break, Momentary	X	X	IP 65
FS1 U1RS	51.104	SPDT-DB	10A/500V AC	Slow make-break, Maintained	X	X	IP 65
FS1 SU1	51.105	SPDT-DB	10A/500V AC	Snap Action, Momentary		X	IP 65
FS1 SU1R	51.106	SPDT-DB	10A/500V AC	Snap Action, Maintained		X	IP 65
FS1 SU1S	51.107	SPDT-DB	10A/500V AC	Snap Action, Momentary	X	X	IP 65
FS1 SU1RS	51.108	SPDT-DB	10A/500V AC	Snap Action, Maintained	X	X	IP 65
FS1 U2	51.109	DPDT-DB	10A/500V AC	Slow make-break, Momentary*		X	IP 65
FS1 U1DU1	51.110	2x SPDT-DB	10A/500V AC	Slow make-break, Two Stage Momentary		X	IP 65
FS1 U2S	51.111	DPDT-DB	10A/500V AC	Slow make-break, Momentary*	X	X	IP 65
FS1 U1DU1S	51.112	2x SPDT-DB	10A/500V AC	Slow make-break, Two Stage Momentary	X	X	IP 65
FS1 SU2	51.113	DPDT-DB	10A/500V AC	Snap Action, Momentary*		X	IP 65
FS1 SU1DSU1	51.114	2x SPDT-DB	10A/500V AC	Snap Action, Two Stage Momentary		X	IP 65
FS1 SU2S	51.115	DPDT-DB	10A/500V AC	Snap Action, Momentary*	X	X	IP 65
FS1 SU1DSU1S	51.116	2x SPDT-DB	10A/500V AC	Snap Action, Two Stage Momentary	X	X	IP 65
FS1 SU1P10 L	51.117	10k Ohm, 2.0W Potentiometer with SPDT-SB Microswitch (5A/250V AC)				Solder Tabs	IP 65

 Gray body, red cover and black (Anti-Trip: gray) pedal

Options

- Protection Level: - Ex - Explosion protected
- Switch Insert: - Gold plated contacts for low current applications
Electrical Rating: Max. Power Consumption: 12.5mW at max. 25mA or max. 25V DC
- Strain Relief: - Standard straight-through (IP 68)
- Bend protection (IP 68)
- Trumpet Pull/Bend protection (IP 68)
- Cable: - Multi conductor, PVC, SJT
- Multi conductor, PVC, SJT, shielded
- Per customer specifications
- Connectors: - Per customer specifications
- IEC 601-1 certified
- Other potentiometer values available upon request
- Custom colors available upon request
- Foot rest also available

Dimensions



* Maintained contacts available upon request

FS1 ... U

- Heavy duty medium size, one pedal foot switch

Standard Features

- **Housing:** Die cast aluminum body and Polyamide 6.6 pedal
- **Guard:** Die cast aluminum
 - Colors: Gray body, red guard and black pedal
 - Anti-Trip: Die cast aluminum pedal and lever in gray (available on some models)
- **Protection Level:** IP 65
- **Switch Insert:** Snap action or slow make-break
 - Silver alloy contact material
 - Electrical Rating: 10A/500V AC (If used with appropriate cable, see cable chart on page 29)
 - Contact Types: Momentary, maintained, or two stage momentary
 - Circuit: SPDT-DB; DBDT-DB; 10k Ohm, 2.0W Potentiometer with SPDT-SB microswitch
- **Cable Entry:** Threaded hole (M20)
- **Temperature Range:** -30°C up to +80°C (-22°F up to +176°F)



Ordering Information

Type	Catalog No.	Circuit Function	Electrical Ratings	Switch/Contact Type	Anti-Trip	Cable Screw Terminals	Protection Level
FS1 ... U - with Foot Guard							
FS1 U1 U	51.151	SPDT-DB	10A/500V AC	Slow make-break, Momentary		X	IP 65
FS1 U1R U	51.152	SPDT-DB	10A/500V AC	Slow make-break, Maintained		X	IP 65
FS1 U1S U	51.153	SPDT-DB	10A/500V AC	Slow make-break, Momentary	X	X	IP 65
FS1 U1RS U	51.154	SPDT-DB	10A/500V AC	Slow make-break, Maintained	X	X	IP 65
FS1 SU1 U	51.155	SPDT-DB	10A/500V AC	Snap Action, Momentary		X	IP 65
FS1 SU1R U	51.156	SPDT-DB	10A/500V AC	Snap Action, Maintained		X	IP 65
FS1 SU1S U	51.157	SPDT-DB	10A/500V AC	Snap Action, Momentary	X	X	IP 65
FS1 SU1RS U	51.158	SPDT-DB	10A/500V AC	Snap Action, Maintained	X	X	IP 65
FS1 U2 U	51.159	DPDT-DB	10A/500V AC	Slow make-break, Momentary*		X	IP 65
FS1 U1DU1 U	51.160	2x SPDT-DB	10A/500V AC	Slow make-break, Two Stage Momentary		X	IP 65
FS1 U2S U	51.161	DPDT-DB	10A/500V AC	Slow make-break, Momentary*	X	X	IP 65
FS1 U1DU1S U	51.162	2x SPDT-DB	10A/500V AC	Slow make-break, Two Stage Momentary	X	X	IP 65
FS1 SU2 U	51.163	DPDT-DB	10A/500V AC	Snap Action, Momentary*		X	IP 65
FS1 SU1DSU1 U	51.164	2x SPDT-DB	10A/500V AC	Snap Action, Two Stage Momentary		X	IP 65
FS1 SU2S U	51.165	DPDT-DB	10A/500V AC	Snap Action, Momentary*	X	X	IP 65
FS1 SU1DSU1S U	51.166	2x SPDT-DB	10A/500V AC	Snap Action, Two Stage Momentary	X	X	IP 65
FS1 SU1P10 L U	51.167	10k Ohm, 2.0W Potentiometer with SPDT-SB Microswitch				Solder Tabs	IP 65
FS1 ... V U - Safety Foot Switch with Guard							
FS1 S1DO1 V U	51.197	SPDT-DB	10A/500V AC	Normal: Slow make-break, Momentary Safety: Maintained, Manual reset		X	IP 65
FS1 S2DO2 V U	51.198	DPDT-DB	10A/500V AC	Normal: Slow make-break, Momentary Safety: Maintained, Manual reset		X	IP 65
FS1 U1DU1 V U	51.199	Two Stage 2x SPDT-DB	10A/500V AC	Normal: Slow make-break, Momentary Safety: Maintained, Manual reset		X	IP 65

[R] Gray body, red cover and black (Anti-Trip: gray) pedal

Options

- **Protection Level:** - Ex - Explosion protected
- **Switch Insert:** - Gold plated contacts for low current applications
 - Electrical Rating: Max. Power Consumption: 12.5mW at max. 25mA or max. 25V DC
- **Strain Relief:**
 - Standard straight-through (IP 68)
 - Bend protection (IP 68)
 - Trumpet Pull/Bend protection (IP 68)
- **Cable:**
 - Multi conductor, PVC, SJT
 - Multi conductor, PVC, SJT, shielded
 - Per customer specifications
- **Connectors:** - Per customer specifications
- IEC 601-1 certified
- Die cast aluminum pedal
- Other potentiometer values available upon request
- Custom colors available upon request
- Foot rest also available

* Maintained contacts available upon request



FS2

- Heavy duty medium size, two pedal foot switch

Standard Features

- Housing: Die cast aluminum body and cover with Polyamide 6.6 pedals
- Colors: Gray body, red cover and black pedals
- Anti-Trip: Die cast aluminum pedal and lever in gray (available on some models)
- Protection Level: IP 65
- Switch Insert: Snap action or slow make-break
Silver alloy contact material
- Electrical Rating: 10A/500V AC (If used with appropriate cable, see cable chart on page 29)
- Contact Types: Momentary, maintained, or two stage momentary
- Circuit: SPDT-DB; DPDT-DB
- Cable Entry: Three threaded holes (M20)
- Temperature Range: -30°C up to +80°C (-22°F up to +176°F)



Ordering Information

Type	Catalog No.	Circuit Function	Electrical Ratings	Switch/Contact Type	Anti-Trip	Cable Screw Terminals	Protection Level
FS2							
FS2 U1 (2x)	51.201	<input type="checkbox"/> SPDT-DB	10A/500V AC	Slow make-break, Momentary		X	IP 65
FS2 U1R (2x)	51.202	<input type="checkbox"/> SPDT-DB	10A/500V AC	Slow make-break, Maintained		X	IP 65
FS2 U1S (2x)	51.203	<input type="checkbox"/> SPDT-DB	10A/500V AC	Slow make-break, Momentary	X	X	IP 65
FS2 U1RS (2x)	51.204	<input type="checkbox"/> SPDT-DB	10A/500V AC	Slow make-break, Maintained	X	X	IP 65
FS2 SU1 (2x)	51.205	<input type="checkbox"/> SPDT-DB	10A/500V AC	Snap Action, Momentary		X	IP 65
FS2 SU1R (2x)	51.206	<input type="checkbox"/> SPDT-DB	10A/500V AC	Snap Action, Maintained		X	IP 65
FS2 SU1S (2x)	51.207	<input type="checkbox"/> SPDT-DB	10A/500V AC	Snap Action, Momentary	X	X	IP 65
FS2 SU1RS (2x)	51.208	<input type="checkbox"/> SPDT-DB	10A/500V AC	Snap Action, Maintained	X	X	IP 65
FS2 U2 (2x)	51.209	<input type="checkbox"/> DPDT-DB	10A/500V AC	Slow make-break, Momentary*		X	IP 65
FS2 U1DU1 (2x)	51.210	<input type="checkbox"/> 2x SPDT-DB	10A/500V AC	Slow make-break, Two Stage Momentary		X	IP 65
FS2 U2S (2x)	51.211	<input type="checkbox"/> DPDT-DB	10A/500V AC	Slow make-break, Momentary*	X	X	IP 65
FS2 U1DU1S (2x)	51.212	<input type="checkbox"/> 2x SPDT-DB	10A/500V AC	Slow make-break, Two Stage Momentary	X	X	IP 65
FS2 SU2 (2x)	51.213	<input type="checkbox"/> DPDT-DB	10A/500V AC	Snap Action, Momentary*		X	IP 65
FS2 SU1DSU1(2x)	51.214	<input type="checkbox"/> 2x SPDT-DB	10A/500V AC	Snap Action, Two Stage Momentary		X	IP 65
FS2 SU2S (2x)	51.215	<input type="checkbox"/> DPDT-DB	10A/500V AC	Snap Action, Momentary*	X	X	IP 65
FS2 SU1DSU1S (2x)	51.216	<input type="checkbox"/> 2x SPDT-DB	10A/500V AC	Snap Action, Two Stage Momentary	X	X	IP 65

Gray body, red cover and black (Anti-Trip: gray) pedal

Options

- Protection Level: - Ex - Explosion protected
- Switch Insert: - Gold plated contacts for low current applications
Electrical Rating: Max. Power Consumption: 12.5mW at max. 25mA or max. 25V DC
- Strain Relief: - Standard straight-through (IP 68)
- Bend protection (IP 68)
- Trumpet Pull/Bend protection (IP 68)
- Cable: - Multi conductor, PVC, SJT
- Multi conductor, PVC, SJT, shielded
- Per customer specifications
- Connectors: - Per customer specifications
- IEC 601-1 certified
- Die cast aluminum pedal
- Potentiometer available upon request
- Custom colors available upon request
- Combination of different switch inserts

Dimensions



* Maintained contacts available upon request

FS2 ... U

- Heavy duty medium size, two pedal foot switch with guard

Standard Features

- Housing: Die cast aluminum body with Polyamide 6.6 pedals
- Guard: Die cast aluminum
 - Colors: Gray body, red guard and black pedals
 - Anti-Trip: Die cast aluminum pedal and lever in gray (available on some models)
- Protection Level: IP 65
- Switch Insert: Snap action or slow make-break
 - Silver alloy contact material
 - Electrical Rating: 10A/500V AC (If used with appropriate cable, see cable chart on page 29)
 - Contact Types: Momentary, maintained, or two stage momentary
 - Circuit: SPDT-DB; DPDT-DB
- Cable Entry: Three threaded holes (M20)
- Temperature Range: -30°C up to +80°C (-22°F up to +176°F)



Ordering Information

Type	Catalog No.	Circuit Function	Electrical Ratings	Switch/Contact Type	Anti-Trip	Cable Screw Terminals	Protection Level
FS2 ... U - with Foot Guard							
FS2 U1 (2x) U	51.251	SPDT-DB	10A/500V AC	Slow make-break, Momentary		X	IP 65
FS2 U1R (2x) U	51.252	SPDT-DB	10A/500V AC	Slow make-break, Maintained		X	IP 65
FS2 U1S (2x) U	51.253	SPDT-DB	10A/500V AC	Slow make-break, Momentary	X	X	IP 65
FS2 U1RS (2x) U	51.254	SPDT-DB	10A/500V AC	Slow make-break, Maintained	X	X	IP 65
FS2 SU1 (2x) U	51.255	SPDT-DB	10A/500V AC	Snap Action, Momentary		X	IP 65
FS2 SU1R (2x) U	51.256	SPDT-DB	10A/500V AC	Snap Action, Maintained		X	IP 65
FS2 SU1S (2x) U	51.257	SPDT-DB	10A/500V AC	Snap Action, Momentary	X	X	IP 65
FS2 SU1RS (2x) U	51.258	SPDT-DB	10A/500V AC	Snap Action, Maintained	X	X	IP 65
FS2 U2 (2x) U	51.259	DPDT-DB	10A/500V AC	Slow make-break, Momentary*		X	IP 65
FS2 U1DU1 (2x) U	51.260	2x SPDT-DB	10A/500V AC	Slow make-break, Two Stage Momentary		X	IP 65
FS2 U2S (2x) U	51.261	DPDT-DB	10A/500V AC	Slow make-break, Momentary*	X	X	IP 65
FS2 U1DU1S (2x) U	51.262	2x SPDT-DB	10A/500V AC	Slow make-break, Two Stage Momentary	X	X	IP 65
FS2 SU2 (2x) U	51.263	DPDT-DB	10A/500V AC	Snap Action, Momentary*		X	IP 65
FS2 SU1DSU1 (2x) U	51.264	2x SPDT-DB	10A/500V AC	Snap Action, Two Stage Momentary		X	IP 65
FS2 SU2S (2x) U	51.265	DPDT-DB	10A/500V AC	Snap Action, Momentary*	X	X	IP 65
FS2 SU1DSU1S (2x) U	51.266	2x SPDT-DB	10A/500V AC	Snap Action, Two Stage Momentary	X	X	IP 65

FS2 ... V U - Safety Foot Switch with Guard

FS2 S1DO1 V(2x) U	51.297	SPDT-DB	10A/500V AC	Normal: Slow make-break, Momentary Safety: Maintained, Manual reset		X	IP 65
FS2 S2DO2 V(2x) U	51.298	DPDT-DB	10A/500V AC	Normal: Slow make-break, Momentary Safety: Maintained, Manual reset		X	IP 65
FS2 U1DU1 V(2x) U	51.299	Two Stage 2x SPDT-DB	10A/500V AC	Normal: Slow make-break, Momentary Safety: Maintained, Manual reset		X	IP 65

Gray body, red cover and black (Anti-Trip: gray) pedal

Options

- Protection Level: - Ex - Explosion protected
- Switch Insert: - Gold plated contacts for low current applications
 - Electrical Rating: Max. Power Consumption: 12.5mW at max. 25mA or 25V DC
- Strain Relief: - Standard straight-through (IP 68)
 - Bend protection (IP 68)
 - Trumpet Pull/Bend protection (IP 68)
- Cable: - Multi conductor, PVC, SJT
 - Multi conductor, PVC, SJT, shielded
 - Per customer specifications
- Connectors: - Per customer specifications
- IEC 601-1 certified
- Die cast aluminum pedal
- Potentiometer available upon request
- Custom colors available upon request
- Combination of different switch inserts

* Maintained contacts available upon request

Dimensions



ALTECH CORP®, 35 ROYAL ROAD, FLEMINGTON, NJ 08822-6000 • 908.806.9400

FS3

- Heavy duty medium size, three pedal foot switch

Standard Features

- Housing: Die cast aluminum body and cover with Polyamide 6.6 pedals
Colors: Gray body, red cover and black pedals
Anti-Trip: Die cast aluminum pedal and lever in gray (available on some models)
- Protection Level: IP 65
- Switch Insert: Snap action or slow make-break
Silver alloy contact material
Electrical Rating: 10A/500V AC (If used with appropriate cable, see cable chart on page 29)
Contact Types: Momentary, maintained, or two stage momentary
Circuit: SPDT-DB; DPDT-DB
- Cable Entry: Three threaded holes (M20)
- Temperature Range: -30°C up to +80°C (-22°F up to +176°F)



Ordering Information

Type	Catalog No.	Circuit Function	Electrical Ratings	Switch/Contact Type	Anti-Trip	Cable Screw Terminals	Protection Level
FS3							
FS3 U1 (3x)	51.301	<input type="checkbox"/> SPDT-DB	10A/500V AC	Slow make-break, Momentary		X	IP 65
FS3 U1R (3x)	51.302	<input type="checkbox"/> SPDT-DB	10A/500V AC	Slow make-break, Maintained		X	IP 65
FS3 U1S (3x)	51.303	<input type="checkbox"/> SPDT-DB	10A/500V AC	Slow make-break, Momentary	X	X	IP 65
FS3 U1RS (3x)	51.304	<input type="checkbox"/> SPDT-DB	10A/500V AC	Slow make-break, Maintained	X	X	IP 65
FS3 SU1 (3x)	51.305	<input type="checkbox"/> SPDT-DB	10A/500V AC	Snap Action, Momentary		X	IP 65
FS3 SU1R (3x)	51.306	<input type="checkbox"/> SPDT-DB	10A/500V AC	Snap Action, Maintained		X	IP 65
FS3 SU1S (3x)	51.307	<input type="checkbox"/> SPDT-DB	10A/500V AC	Snap Action, Momentary	X	X	IP 65
FS3 SU1RS (3x)	51.308	<input type="checkbox"/> SPDT-DB	10A/500V AC	Snap Action, Maintained	X	X	IP 65
FS3 U2 (3x)	51.309	<input type="checkbox"/> DPDT-DB	10A/500V AC	Slow make-break, Momentary*		X	IP 65
FS3 U1DU1 (3x)	51.310	<input type="checkbox"/> 2x SPDT-DB	10A/500V AC	Slow make-break, Two Stage Momentary		X	IP 65
FS3 U2S (3x)	51.311	<input type="checkbox"/> DPDT-DB	10A/500V AC	Slow make-break, Momentary*	X	X	IP 65
FS3 U1DU1S (3x)	51.312	<input type="checkbox"/> 2x SPDT-DB	10A/500V AC	Slow make-break, Two Stage Momentary	X	X	IP 65
FS3 SU2 (3x)	51.313	<input type="checkbox"/> DPDT-DB	10A/500V AC	Snap Action, Momentary*		X	IP 65
FS3 SU1DSU1 (3x)	51.314	<input type="checkbox"/> 2x SPDT-DB	10A/500V AC	Snap Action, Two Stage Momentary		X	IP 65
FS3 SU2S (3x)	51.315	<input type="checkbox"/> DPDT-DB	10A/500V AC	Snap Action, Momentary*	X	X	IP 65
FS3 SU1DSU1S (3x)	51.316	<input type="checkbox"/> 2x SPDT-DB	10A/500V AC	Snap Action, Two Stage Momentary	X	X	IP 65

Gray body, red cover and black (Anti-Trip: gray) pedal

Options

- Protection Level: - Ex - Explosion protected
- Switch Insert: - Gold plated contacts for low current applications
Electrical Rating: Max. Power Consumption: 12.5mW at max. 25mA or max. 25V DC
- Strain Relief: - Standard straight-through (IP 68)
- Bend protection (IP 68)
- Trumpet Pull/Bend protection (IP 68)
- Cable: - Multi conductor, PVC, SJT
- Multi conductor, PVC, SJT, shielded
- Per customer specifications
- Connectors: - Per customer specifications
- IEC 601-1 certified
- Die cast aluminum pedal
- Potentiometer available upon request
- Custom colors available upon request
- Combination of different switch inserts

Dimensions



* Maintained contacts available upon request

FS3 ... U

- Heavy duty medium size, three pedal foot switch with guard

Standard Features

- Housing: Die cast aluminum body and Polyamide 6.6 pedals
- Guard: Die cast aluminum
 - Colors: Gray body, red guard and black pedals
 - Anti-Trip: Die cast aluminum pedal and lever in gray (available on some models)
- Protection Level: IP 65
- Switch Insert: Snap action or slow make-break
 - Silver alloy contact material
- Electrical Rating: 10A/500V AC (If used with appropriate cable, see cable chart on page 29)
- Contact Types: Momentary, maintained, or two stage momentary
- Circuit: SPDT-DB; DPDT-DB
- Cable Entry: Three threaded holes (M20)
- Temperature Range: -30°C up to +80°C (-22°F up to +176°F)



Ordering Information

Type	Catalog No.	Circuit Function	Electrical Ratings	Switch/Contact Type	Anti-Trip	Cable Screw Terminals	Protection Level
FS3 ... U - with Foot Guard							
FS3 U1 (3x) U	51.351	SPDT-DB	10A/500V AC	Slow make-break, Momentary		X	IP 65
FS3 U1R (3x) U	51.352	SPDT-DB	10A/500V AC	Slow make-break, Maintained		X	IP 65
FS3 U1S (3xs) U	51.353	SPDT-DB	10A/500V AC	Slow make-break	X	X	IP 65
FS3 U1RS (3x) U	51.354	SPDT-DB	10A/500V AC	Slow make-break, Maintained	X	X	IP 65
FS3 SU1 (3x) U	51.355	SPDT-DB	10A/500V AC	Snap Action, Momentary		X	IP 65
FS3 SU1R (3x) U	51.356	SPDT-DB	10A/500V AC	Snap Action, Maintained		X	IP 65
FS3 SU1S (3x) U	51.357	SPDT-DB	10A/500V AC	Snap Action	X	X	IP 65
FS3 SU1RS (3x) U	51.358	SPDT-DB	10A/500V AC	Snap Action, Maintained	X	X	IP 65
FS3 U2 (3x) U	51.359	DPDT-DB	10A/500V AC	Slow make-break, Momentary*		X	IP 65
FS3 U1DU1 (3x) U	51.360	2x SPDT-DB	10A/500V AC	Slow make-break, Two Stage Momentary		X	IP 65
FS3 U2S (3x) U	51.361	DPDT-DB	10A/500V AC	Slow make-break, Momentary*	X	X	IP 65
FS3 U1DU1S (3x) U	51.362	2x SPDT-DB	10A/500V AC	Slow make-break, Two Stage Momentary	X	X	IP 65
FS3 SU2 (3x) U	51.363	DPDT-DB	10A/500V AC	Snap Action, Momentary*		X	IP 65
FS3 SU1DSU1 (3x) U	51.364	2x SPDT-DB	10A/500V AC	Snap Action, Two Stage Momentary		X	IP 65
FS3 SU2S (3x) U	51.365	DPDT-DB	10A/500V AC	Snap Action, Momentary*	X	X	IP 65
FS3 SU1DSU1S (3x) U	51.366	2x SPDT-DB	10A/500V AC	Snap Action, Two Stage Momentary	X	X	IP 65

Gray body, red cover and black (Anti-Trip: gray) pedal

Options

- Protection Level: - Ex - Explosion protected
- Switch Insert: - Gold plated contacts for low current applications
 - Electrical Rating: Max. Power Consumption: 12.5mW at max. 25mA or max. 25V DC
- Strain Relief: - Standard straight-through (IP 68)
 - Bend protection (IP 68)
 - Trumpet Pull/Bend protection (IP 68)
- Cable: - Multi conductor, PVC, SJT
 - Multi conductor, PVC, SJT, shielded
 - Per customer specifications
- Connectors: - Per customer specifications
- IEC 601-1 certified
- Die cast aluminum pedal
- Potentiometer available upon request
- Custom colors available upon request
- Combination of different switch inserts

Dimensions



* Maintained contacts available upon request

WARNING for General Applications

The use of foot switches on machines, which do not have “point of operation” and “pinch point” protection can cause serious injuries to the operator!

The point of operation and pinch point guarding devices should be properly installed before a foot switch is used. The foot controls should be utilized so that it is impossible for the operator’s hands and fingers to remain within the point of operation during the machine cycle.

Point of operation - The point or area of the machine or the equipment where the work piece or material is positioned and work is being performed during any process such as forming, cutting, welding, punching, shearing, assembling, riveting, etc.

Pinch point - Any point at which it is possible for a portion of the body to be caught and injured between moving machine or equipment or work piece parts.

Additional WARNING for Medical Applications

Medical environments have high demands for safety and hygiene. The use of inadequate foot switches can cause serious injuries to the user and patient! The Altech/ASA foot switches meet the requirements of IEC 60601-1 for medical electrical equipment.



- **Protection Level IP 68 (Immersion in water)**
- **Limited voltage rating to 25V~ (AC)/60V --- (DC)**
- **UL/CSA, VDE approved switch insert**
- **Installed cable with special pull/bend protection strain relief**
- **Special durability inspection and drop test of housing**
- **Alternative colors to differentiate this special application**

The **IEC 60601-1** certification for this special application is issued by TÜV Essen/RWTÜV. This organization is a Notified Body by the European Union and has Governmental accreditation for all types of certification plans for Medical Devices.

Nevertheless, it is the responsibility of the user to select the suitable foot switch for his application. Altech can only make suggestions for the proper use in special applications. Otherwise the correct installation and wiring of the foot switch should comply with all Federal, State and Local safety and health regulations.

FEATURES APPLICABLE TO THE FS SERIES

Safety Foot Switch



To prevent accidents, Altech/ASA has included a special safety foot switch in its line. The concept is based on an extensive survey, which indicated that, in case of an accident the user depresses the foot pedal even harder instead of releasing the pedal. This special safety foot switch is designed to compensate for this emergency situation, by breaking electrical contact when the pedal is completely depressed. It has modified, two stage momentary contact types, with a manual reset button.

Safety Foot Switch Functions

“OFF”



Step 1: The pedal is not depressed. The contacts are open. The machine is turned off.

“ON”



Step 2: To start the machine, the pedal must be depressed until the “pressure point”, where resistance is noticeable.

“EMERGENCY -
OFF”



Step 3: In an emergency, if the pedal is depressed beyond the pressure point, the machine will stop. Beyond the pressure point, the contacts are locked in the “OFF” - Position. The machine cannot operate at this time.

Note: The machine can also be stopped, by releasing the pedal instead of depressing harder. (Back to Step 1)

“RESET”



Step 4: The push button on the side of the foot switch must be pushed by hand to enable the foot switch to start the machine function again.

“ON”



Step 5: Return to condition described in Step 2.

The safety foot switch is available in the one and two pedal heavy duty with guard versions. See pages 20 and 22 for more information on the FS1 ... U and FS2 ... U Series.

FEATURES APPLICABLE TO THE FL AND FS SERIES *

Foot Guards

Foot Guards are used to prevent accidentally actuating the foot switch by falling objects such as parts and tools.

Most European accident prevention standards such as the German Berufsgenossenschaft (BG) (similar function to OSHA) require foot guards for many applications. In addition there is a special space under the guard, where certain devices such as, emergency off switches and contactors can be mounted.



Foot Rests

Ergonomically designed foot rests help reduce fatigue that may set in after operating a foot switch for an extended period of time.

Foot rests are available on the one pedal versions of the FL and FS series, with or without a guard.



Anti-Trip Lever Mechanism

(Prevents the pedal from accidental actuation)



Step 1: To depress the pedal, the Anti-Trip lever must be pushed forward. Otherwise, a spring loaded mechanism holds the lever in position.



Step 2: After the lever is pushed forward, the pedal can be easily depressed.



Step 3: Immediately after releasing the pedal, the spring loaded mechanism brings the lever back to its starting position.

The maximum human safety and machine protection is provided by the combination of Anti-Trip lever mechanism and Foot Guards!

Potentiometers

Foot switches can be ordered with built-in potentiometers to change speed, etc. Typical applications include:

- Coil Winding Machines
- Machine Tools
- Medical Facilities
- Pumps
- Sewing Machines
- Welding Machines

Function: In the "OFF" position the potentiometer is at "zero". A microswitch connected in series to the potentiometer will only provide a voltage to the potentiometer once the foot switch has been activated.



The standard resistance of the potentiometer foot switch is 10k Ohm which provides a proportional signal depending on the position of the foot pedal (Resistances of 100 Ohm to 20k Ohm are also available). Potentiometers are available for the FL and

FS Series.

Two Stage Function

The following describes the mechanical operation of two momentary contact types:

Stage 1: To activate the first momentary contact, depress the pedal until resistance is noticeable.

Stage 2: To activate the second momentary contact, press the pedal beyond the resistance point.

Both functions are now turned on. By releasing the pedal, the functions will be turned off in reversed direction.



* The two stage function is applicable to all foot switches.

SWITCH SPECIFICATIONS

Contact Types

• Momentary

To start the function, press the pedal.
Release the pedal to stop.
(Press to start - Release to stop)

• Maintained

To start the function, press the pedal. After releasing the pedal, the contacts remain in the "ON" position unless the user presses and releases the pedal again.



Switch Types

• Slow make-break

With double throw contacts where the moving contact, in transferring, interrupts one circuit before establishing the other.

• Snap Action

The action of moving contact members that transfer from one position to another at a speed which is essentially independent of actuator speed.

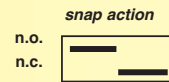

Contact Configuration

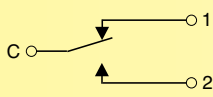
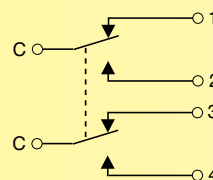
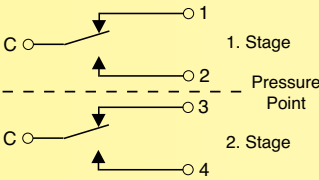
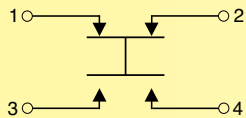
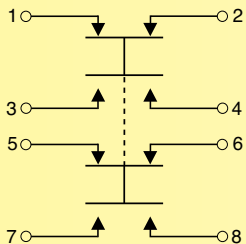
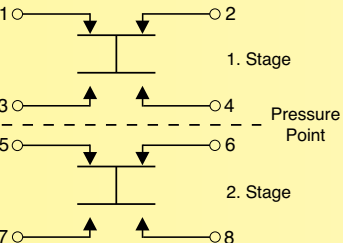
Foot Switch	Circuit Function	Contact Symbol	Other common expressions used	Description
FM Series & FK Series	SPDT-SB (Single Pole, Double Throw, Single Break)		<ul style="list-style-type: none"> • Form C • Break, Make • Changeover 	With a SPDT-SB contact, one circuit opens at almost the same time another circuit closes. The contact can also be wired as a n.o. (contacts C and 2) or a n.c. (contacts C and 1).
	DPDT-SB (Double Pole, Double Throw, Single Break)		<ul style="list-style-type: none"> • Form CC • 2x Break, Make • 2x Changeover 	Twice the function of a SPDT-SB.
	2x SPDT-SB (2x Single Pole, Double Throw, Single Break)		<ol style="list-style-type: none"> 1. Stage SPDT-SB* 2. Stage SPDT-SB* <p>(* Form C; Break, Make; Changeover)</p>	1 SPDT-SB contact before the pressure point and 1 SPDT-SB contact beyond the pressure point.
FL Series & FS Series	SPDT-DB (Single Pole, Double Throw, Double Break)		<ul style="list-style-type: none"> • Form Z • 1 n.o. / 1 n.c. 	Contacts 1 and 2 are the 1 n.c. Contacts 3 and 4 are the 1 n.o.
	DPDT-DB (Double Pole, Double Throw, Double Break)		<ul style="list-style-type: none"> • Form ZZ • 2 n.o. / 2 n.c. 	Contacts 1, 2 and 5, 6 are 2 n.c. Contacts 3, 4 and 7, 8 are 2 n.o.
	2x SPDT-DB		<ol style="list-style-type: none"> 1. Stage SPDT-DB* 2. Stage SPDT-DB* <p>(* Form Z)</p> <ul style="list-style-type: none"> • 2x 1 n.o. / 1 n.c. 	Contacts 1 and 2 are n.c., contacts 3 and 4 are n.o., before the pressure point. Contacts 5 and 6 are n.c., contacts 7 and 8 are n.o., beyond the pressure point.

OPTIONS

IEC 60601-1

International Standard for medical electrical equipment. General requirements for safety.



Medical environments have high demands on safety and hygiene. The certification for this special application is issued by TÜV

Essen/RWTÜV. This organization is a Notified Body by the European Union and has Governmental accreditation for all types of certification plans for Medical Devices. The Altech/ASA foot switches meet the requirements of IEC 60601-1 for medical electrical equipment.

- **Protection Level IP 68**
- **Limited voltage rating to 25V~ (AC)/60V=== (DC)**
- **UL/CSA, VDE approved switch insert**
- **Installed cable with special pull/bend protection strain relief**
- **Special durability inspection and drop test of housing**
- **Alternative colors to differentiate this special application**

The IEC 60601-1 certified foot switches are available in the FM, FL, and FS series.



Explosion Protected - EX

In many industries and environments explosion protected foot switches are required.

Applications include, but are not limited to:

- **Petrochemical Industries**
- **Chemical Industries**
- **Plastic Molding Machines**
- **Printing Machinery**
- **Converting Machines**
- **Wood Processing Machinery**
- **Food Processing Industries**

Altech/ASA foot switches use the principle of flame proof enclosures. Possible explosions are contained inside the foot switch and cannot cause any damage outside.

Altech/ASA Explosion Protected foot switches use special switch inserts which meet the EEX, d, IIC and T6 classifications and can be used in zone 1 and 2 applications to DIN VDE 0165.

EEX = Ex protected to European EN 50014
d = Flameproof enclosure
IIC = Explosion group IIC
T6 = Temperature class 6

Due to the increased safety requirements Altech/ASA EX - Foot switches are always delivered complete with a 3 meter (10 ft.) cable and an EX approved strain relief.

Explosion protected foot switches are only available in the FS Series.

Cable Chart

Foot Switch	AWG Size/ No. of Cond.	Voltage Rating/V	Current Carrying Capacity/Amp.	Overall Diameter		Material	Applications
				Inches	mm		
FM Series, FK Series, PCFS-3M Series	20/2	300	8	.200 - .265	5.08 - 6.73	SJT - Plastic SJO - Neoprene SJTO - Plastic SJOOW - Plastic	Light and medium duty service such as small tools, small motors, sound, office, and medical equipment, etc.
	20/3	300	8	.210 - .292	5.33 - 7.42		
	20/4	300	8	.240 - .322	6.10 - 8.18		
	20/6	300	7	.260 - .381	6.60 - 9.68		
	20/9	300	7	.317 - .439	8.05 - 11.15		
	20/12	300	7	.338 - .478	8.59 - 12.14		
	20/20	300	5	.430 - .561	10.92 - 14.25		
	18/2	300	10	.230 - .301	5.84 - 7.65		
	18/3	300	10	.242 - .318	6.15 - 8.08		
18/4	300	7	.254 - .330	6.45 - 8.38			
FL Series & FS Series	18/2	600	10	.335 - .375	8.51 - 9.53	ST - Plastic SO - Neoprene STO - Plastic SJOOW - Plastic	Heavy duty service such as heavy tools, industrial equipment controls, industrial machinery, medical equipment, etc.
	18/3	600	10	.360 - .390	9.14 - 9.91		
	18/4	600	7	.385 - .420	9.78 - 10.67		
	16/2	600	13	.340 - .400	8.64 - 10.16		
	16/3	600	13	.355 - .420	9.02 - 10.67		
16/4	600	10	.390 - .450	9.91 - 11.43			
This cable chart is only to be used as a guide. If the conditions of use vary (i.e., high temperature, hazardous environments, etc.) the normal cable should not be used. Please contact Altech for special applications.							Note: SJO, SJTO, SO, STO, and SJOOW are resistant against oil, grease, and acid.

Компания «Океан Электроники» предлагает заключение долгосрочных отношений при поставках импортных электронных компонентов на взаимовыгодных условиях!

Наши преимущества:

- Поставка оригинальных импортных электронных компонентов напрямую с производств Америки, Европы и Азии, а так же с крупнейших складов мира;
- Широкая линейка поставок активных и пассивных импортных электронных компонентов (более 30 млн. наименований);
- Поставка сложных, дефицитных, либо снятых с производства позиций;
- Оперативные сроки поставки под заказ (от 5 рабочих дней);
- Экспресс доставка в любую точку России;
- Помощь Конструкторского Отдела и консультации квалифицированных инженеров;
- Техническая поддержка проекта, помощь в подборе аналогов, поставка прототипов;
- Поставка электронных компонентов под контролем ВП;
- Система менеджмента качества сертифицирована по Международному стандарту ISO 9001;
- При необходимости вся продукция военного и аэрокосмического назначения проходит испытания и сертификацию в лаборатории (по согласованию с заказчиком);
- Поставка специализированных компонентов военного и аэрокосмического уровня качества (Xilinx, Altera, Analog Devices, Intersil, Interpoint, Microsemi, Actel, Aeroflex, Peregrine, VPT, Syfer, Eurofarad, Texas Instruments, MS Kennedy, Miteq, Cobham, E2V, MA-COM, Hittite, Mini-Circuits, General Dynamics и др.);

Компания «Океан Электроники» является официальным дистрибьютором и эксклюзивным представителем в России одного из крупнейших производителей разъемов военного и аэрокосмического назначения «JONHON», а так же официальным дистрибьютором и эксклюзивным представителем в России производителя высокотехнологичных и надежных решений для передачи СВЧ сигналов «FORSTAR».



JONHON

«JONHON» (основан в 1970 г.)

Разъемы специального, военного и аэрокосмического назначения:

(Применяются в военной, авиационной, аэрокосмической, морской, железнодорожной, горно- и нефтедобывающей отраслях промышленности)

«FORSTAR» (основан в 1998 г.)

ВЧ соединители, коаксиальные кабели, кабельные сборки и микроволновые компоненты:

(Применяются в телекоммуникациях гражданского и специального назначения, в средствах связи, РЛС, а так же военной, авиационной и аэрокосмической отраслях промышленности).



Телефон: 8 (812) 309-75-97 (многоканальный)

Факс: 8 (812) 320-03-32

Электронная почта: ocean@oceanchips.ru

Web: <http://oceanchips.ru/>

Адрес: 198099, г. Санкт-Петербург, ул. Калинина, д. 2, корп. 4, лит. А