

### FEATURES

- Low phase noise, phase-locked loop (PLL)
  - On-chip VCO tunes from 1.4 GHz to 1.8 GHz
  - Supports external 3.3 V/5 V VCO/VCXO to 2.4 GHz
  - 1 differential or 2 single-ended reference inputs
  - Accepts CMOS, LVPECL, or LVDS references to 250 MHz
  - Accepts 16.62 MHz to 33.3 MHz crystal for reference input
  - Optional reference clock doubler
  - Reference monitoring capability
  - Auto and manual reference switchover/holdover modes, with selectable revertive/nonrevertive switching
  - Glitch-free switchover between references
  - Automatic recovery from holdover
  - Digital or analog lock detect, selectable
  - Optional zero delay operation
- Twelve 800 MHz LVDS outputs divided into 4 groups
  - Each group of 3 has a 1-to-32 divider with phase delay
  - Additive broadband jitter as low as 242 fs rms
  - Channel-to-channel skew grouped outputs <60 ps
  - Each LVDS output can be configured as 2 CMOS outputs (for  $f_{OUT} \leq 250$  MHz)
- Automatic synchronization of all outputs on power-up
- Manual synchronization of outputs as needed
- SPI- and I<sup>2</sup>C-compatible serial control port
- 64-lead LFCSP
- Nonvolatile EEPROM stores configuration settings

### APPLICATIONS

- Low jitter, low phase noise clock distribution
- Clock generation and translation for SONET, 10G<sub>FC</sub>, and other 10 Gbps protocols
- Forward error correction (G.710)
- Clocking high speed ADCs, DACs, DDSs, DDCs, DUCs, MxFEs
- High performance wireless transceivers
- ATE and high performance instrumentation
- Broadband infrastructures

### GENERAL DESCRIPTION

The AD9522-4<sup>1</sup> provides a multioutput clock distribution function with subpicosecond jitter performance, along with an on-chip PLL and VCO. The on-chip VCO tunes from 1.4 GHz to 1.8 GHz. An external 3.3 V/5 V VCO/VCXO of up to 2.4 GHz can also be used.

<sup>1</sup>The AD9522 is used throughout this data sheet to refer to all the members of the AD9522 family. However, when AD9522-4 is used, it is referring to that specific member of the AD9522 family.

#### Rev. 0

Information furnished by Analog Devices is believed to be accurate and reliable. However, no responsibility is assumed by Analog Devices for its use, nor for any infringements of patents or other rights of third parties that may result from its use. Specifications subject to change without notice. No license is granted by implication or otherwise under any patent or patent rights of Analog Devices. Trademarks and registered trademarks are the property of their respective owners.

### FUNCTIONAL BLOCK DIAGRAM

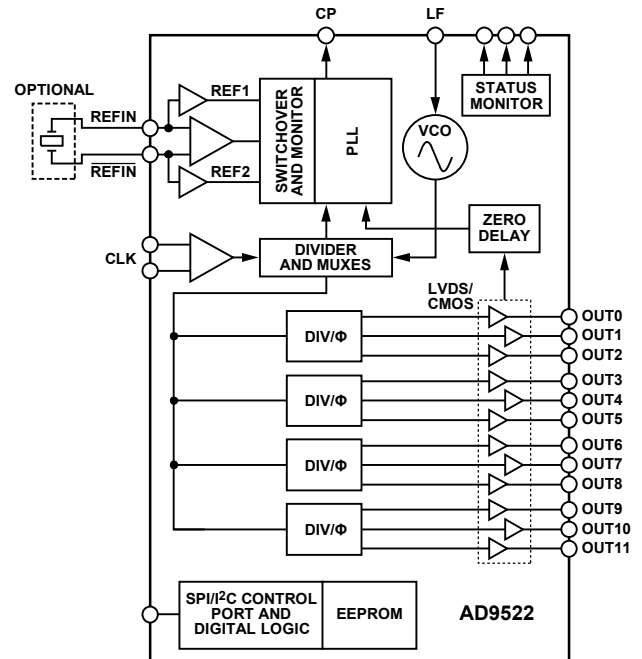

Figure 1.

The AD9522 serial interface supports both SPI and I<sup>2</sup>C ports. An in-package EEPROM can be programmed through the serial interface and store user-defined register settings for power-up and chip reset.

The AD9522 features 12 LVDS outputs in four groups. Any of the 800 MHz LVDS outputs can be reconfigured as two 250 MHz CMOS outputs.

Each group of outputs has a divider that allows both the divide ratio (from 1 to 32) and the phase (coarse delay) to be set.

The AD9522 is available in a 64-lead LFCSP and can be operated from a single 3.3 V supply. The external VCO can have an operating voltage up to 5.5 V.

The AD9522 is specified for operation over the standard industrial range of -40°C to +85°C.

The AD9520-4 is an equivalent part to the AD9522-4 featuring LVPECL/CMOS drivers instead of LVDS/CMOS drivers.

## TABLE OF CONTENTS

Features .....	1	Mode 1: Clock Distribution or External VCO < 1600 MHz .....	29
Applications .....	1	Mode 2: High Frequency Clock Distribution—CLK or External VCO > 1600 MHz .....	31
General Description .....	1	Phase-Locked Loop (PLL) .....	33
Functional Block Diagram .....	1	Configuration of the PLL .....	33
Revision History .....	3	Phase Frequency Detector (PFD) .....	33
Specifications .....	4	Charge Pump (CP) .....	34
Power Supply Requirements .....	4	On-Chip VCO .....	34
PLL Characteristics .....	4	PLL External Loop Filter .....	34
Clock Inputs .....	7	PLL Reference Inputs .....	34
Clock Outputs .....	7	Reference Switchover .....	35
Timing Characteristics .....	8	Reference Divider R .....	35
Timing Diagrams .....	8	VCO/VCXO Feedback Divider N: P, A, B, R .....	35
Clock Output Additive Phase Noise (Distribution Only; VCO Divider Not Used) .....	9	Digital Lock Detect (DLD) .....	37
Clock Output Absolute Phase Noise (Internal VCO Used) ..	10	Analog Lock Detect (ALD) .....	37
Clock Output Absolute Time Jitter (Clock Generation Using Internal VCO) .....	10	Current Source Digital Lock Detect (CSDLD) .....	37
Clock Output Absolute Time Jitter (Clock Cleanup Using Internal VCO) .....	10	External VCXO/VCO Clock Input (CLK/CLK) .....	38
Clock Output Absolute Time Jitter (Clock Generation Using External VCXO) .....	11	Holdover .....	38
Clock Output Additive Time Jitter (VCO Divider Not Used) .....	11	External/Manual Holdover Mode .....	38
Clock Output Additive Time Jitter (VCO Divider Used) .....	12	Automatic/Internal Holdover Mode .....	38
Serial Control Port—SPI Mode .....	12	Frequency Status Monitors .....	40
Serial Control Port—I <sup>2</sup> C Mode .....	13	VCO Calibration .....	41
PD, SYNC, and RESET Pins .....	14	Zero Delay Operation .....	42
Serial Port Setup Pins: SP1, SP0 .....	14	Internal Zero Delay Mode .....	42
LD, STATUS, and REFMON Pins .....	14	External Zero Delay Mode .....	42
Power Dissipation .....	15	Clock Distribution .....	43
Absolute Maximum Ratings .....	16	Operation Modes .....	43
Thermal Resistance .....	16	Clock Frequency Division .....	44
ESD Caution .....	16	VCO Divider .....	44
Pin Configuration and Function Descriptions .....	17	Channel Dividers .....	44
Typical Performance Characteristics .....	20	Synchronizing the Outputs—SYNC Function .....	46
Terminology .....	25	LVDS Output Drivers .....	47
Detailed Block Diagram .....	26	CMOS Output Drivers .....	48
Theory of Operation .....	27	Reset Modes .....	48
Operational Configurations .....	27	Power-On Reset .....	48
Mode 0: Internal VCO and Clock Distribution .....	27	Hardware Reset via the RESET Pin .....	48
		Soft Reset via the Serial Port .....	48
		Soft Reset to Settings in EEPROM when EEPROM Pin = 0 via the Serial Port .....	48

Power-Down Modes .....	48	SPI MSB/LSB First Transfers .....	54
Chip Power-Down via $\overline{PD}$ .....	48	EEPROM Operations .....	57
PLL Power-Down.....	49	Writing to the EEPROM .....	57
Distribution Power-Down .....	49	Reading from the EEPROM .....	57
Individual Clock Output Power-Down.....	49	Programming the EEPROM Buffer Segment.....	58
Individual Clock Channel Power-Down .....	49	Register Section Definition Group .....	58
Serial Control Port .....	50	IO_UPDATE (Operational Code 0x80) .....	58
SPI/I <sup>2</sup> C Port Selection .....	50	End-of-Data (Operational Code 0xFF) .....	58
I <sup>2</sup> C Serial Port Operation.....	50	Pseudo-End-of-Data (Operational Code 0xFE).....	58
I <sup>2</sup> C Bus Characteristics.....	50	Thermal Performance.....	60
Data Transfer Process .....	51	Register Map .....	61
Data Transfer Format .....	52	Register Map Descriptions.....	66
I <sup>2</sup> C Serial Port Timing.....	52	Applications Information.....	80
SPI Serial Port Operation.....	53	Frequency Planning Using the AD9522 .....	80
Pin Descriptions.....	53	Using the AD9522 Outputs for ADC Clock Applications ....	80
SPI Mode Operation.....	53	LVDS Clock Distribution.....	80
Communication Cycle—Instruction Plus Data.....	53	CMOS Clock Distribution.....	81
Write .....	53	Outline Dimensions.....	82
Read .....	53	Ordering Guide .....	82
SPI Instruction Word (16 Bits).....	54		

## REVISION HISTORY

10/08—Revision 0: Initial Version

# AD9522-4

## SPECIFICATIONS

Typical (typ) is given for  $V_S = 3.3\text{ V} \pm 5\%$ ;  $V_S \leq V_{CP} \leq 5.25\text{ V}$ ;  $T_A = 25^\circ\text{C}$ ;  $R_{SET} = 4.12\text{ k}\Omega$ ;  $C_{PRSET} = 5.1\text{ k}\Omega$ , unless otherwise noted. Minimum (min) and maximum (max) values are given over full  $V_S$  and  $T_A$  ( $-40^\circ\text{C}$  to  $+85^\circ\text{C}$ ) variation.

### POWER SUPPLY REQUIREMENTS

Table 1.

Parameter	Min	Typ	Max	Unit	Test Conditions/Comments
$V_S$	3.135	3.3	3.465	V	$3.3\text{ V} \pm 5\%$
VCP	$V_S$		5.25	V	This is nominally 3.3 V to $5.0\text{ V} \pm 5\%$
RSET Pin Resistor		4.12		k $\Omega$	Sets internal biasing currents; connect to ground
CPRSET Pin Resistor		5.1		k $\Omega$	Sets internal CP current range, nominally 4.8 mA ( $CP\_I_{sb} = 600\text{ }\mu\text{A}$ ); actual current can be calculated by $CP\_I_{sb} = 3.06/C_{PRSET}$ ; connect to ground
BYPASS Pin Capacitor		220		nF	Bypass for internal LDO regulator; necessary for LDO stability; connect to ground

### PLL CHARACTERISTICS

Table 2.

Parameter	Min	Typ	Max	Unit	Test Conditions/Comments
VCO (ON-CHIP)					
Frequency Range	1400		1800	MHz	See Figure 13
VCO Gain ( $K_{VCO}$ )		35		MHz/V	See Figure 8
Tuning Voltage ( $V_T$ )	0.5		$V_{CP} - 0.5$	V	$V_{CP} \leq V_S$ when using internal VCO
Frequency Pushing (Open-Loop)		1		MHz/V	
Phase Noise @ 1 kHz Offset		-66		dBc/Hz	LVDS output; $f_{VCO} = 1600\text{ MHz}$ ; $f_{OUT} = 533\text{ MHz}$
Phase Noise @ 100 kHz Offset		-120		dBc/Hz	LVDS output; $f_{VCO} = 1600\text{ MHz}$ ; $f_{OUT} = 533\text{ MHz}$
Phase Noise @ 1 MHz Offset		-137		dBc/Hz	LVDS output; $f_{VCO} = 1600\text{ MHz}$ ; $f_{OUT} = 533\text{ MHz}$
REFERENCE INPUTS					
Differential Mode (REFIN, $\overline{\text{REFIN}}$ )					
Input Frequency	0		250	MHz	Differential mode (can accommodate single-ended input by ac grounding undriven input) Frequencies below about 1 MHz should be dc-coupled; be careful to match $V_{CM}$ (self-bias voltage)
Input Sensitivity		280		mV p-p	
Self-Bias Voltage, REFIN	1.35	1.60	1.75	V	Self-bias voltage of REFIN <sup>1</sup>
Self-Bias Voltage, $\overline{\text{REFIN}}$	1.30	1.50	1.60	V	Self-bias voltage of $\overline{\text{REFIN}}$ <sup>1</sup>
Input Resistance, REFIN	4.0	4.8	5.9	k $\Omega$	Self-biased <sup>1</sup>
Input Resistance, $\overline{\text{REFIN}}$	4.4	5.3	6.4	k $\Omega$	Self-biased <sup>1</sup>
Dual Single-Ended Mode (REF1, REF2)					
Input Frequency (AC-Coupled with DC Offset Off)	10		250	MHz	Slew rate must be $> 50\text{ V}/\mu\text{s}$
Input Frequency (AC-Coupled with DC Offset On)			250	MHz	Slew rate must be $> 50\text{ V}/\mu\text{s}$ , and input amplitude sensitivity specification must be met; see input sensitivity
Input Frequency (DC-Coupled)	0		250	MHz	Slew rate $> 50\text{ V}/\mu\text{s}$ ; CMOS levels
Input Sensitivity (AC-Coupled with DC Offset Off)	0.55		3.28	V p-p	$V_{IH}$ should not exceed $V_S$
Input Sensitivity (AC-Coupled with DC Offset On)	1.5		2.78	V p-p	$V_{IH}$ should not exceed $V_S$
Input Logic High, DC Offset Off	2.0			V	
Input Logic Low, DC Offset Off			0.8	V	
Input Current	-100		+100	$\mu\text{A}$	
Input Capacitance		2		pF	Each pin, REFIN (REF1)/ $\overline{\text{REFIN}}$ (REF2)

Parameter	Min	Typ	Max	Unit	Test Conditions/Comments
Crystal Oscillator Crystal Resonator Frequency Range Maximum Crystal Motional Resistance	16.62		33.33 30	MHz $\Omega$	
PHASE/FREQUENCY DETECTOR (PFD) PFD Input Frequency  Reference Input Clock Doubler Frequency Antibacklash Pulse Width	0.004		100 45 50	MHz MHz MHz	Antibacklash pulse width = 1.3 ns, 2.9 ns Antibacklash pulse width = 6.0 ns Antibacklash pulse width = 1.3 ns, 2.9 ns
		1.3 2.9 6.0		ns ns ns	0x017[1:0] = 01b 0x017[1:0] = 00b; 0x017[1:0] = 11b 0x017[1:0] = 10b
CHARGE PUMP (CP) $I_{CP}$ Sink/Source High Value  Low Value  Absolute Accuracy CPRSET Range $I_{CP}$ High Impedance Mode Leakage Sink-and-Source Current Matching  $I_{CP}$ vs. $V_{CP}$ $I_{CP}$ vs. Temperature	2.7	4.8 0.60 2.5 1 1 1.5 2	10	mA mA % k $\Omega$ nA % % %	Programmable With CPRSET = 5.1 k $\Omega$ ; higher $I_{CP}$ is possible by changing CPRSET With CPRSET = 5.1 k $\Omega$ ; lower $I_{CP}$ is possible by changing CPRSET Charge pump voltage set to $V_{CP}/2$  $0.5 V < V_{CP} < V_{CP} - 0.5 V$ ; $V_{CP}$ is the voltage on the CP (charge pump) pin; $V_{CP}$ is the voltage on the VCP power supply pin $0.5 V < V_{CP} < V_{CP} - 0.5 V$ $V_{CP} = V_{CP}/2 V$
PRESCALER (PART OF N DIVIDER) Prescaler Input Frequency P = 1 FD P = 2 FD P = 3 FD P = 2 DM (2/3) P = 4 DM (4/5) P = 8 DM (8/9) P = 16 DM (16/17) P = 32 DM (32/33) Prescaler Output Frequency			300 600 900 600 1000 2400 3000 3000	MHz MHz MHz MHz MHz MHz MHz MHz	A, B counter input frequency (prescaler input frequency divided by P)
PLL N DIVIDER DELAY 000 001 010 011 100 101 110 111		Off 385 504 623 743 866 989 1112		ps ps ps ps ps ps ps ps	Register 0x019[2:0]; see Table 52
PLL R DIVIDER DELAY 000 001 010 011 100 101 110 111		Off 365 486 608 730 852 976 1101		ps ps ps ps ps ps ps ps	Register 0x019[5:3]; see Table 52

# AD9522-4

Parameter	Min	Typ	Max	Unit	Test Conditions/Comments
<b>PHASE OFFSET IN ZERO DELAY</b>					
Phase Offset (REF-to-LVDS Clock Output Pins) in Internal Zero Delay Mode	1890	2348	3026	ps	REF refers to REF $\overline{\text{IN}}$ (REF1)/REF $\overline{\text{IN}}$ (REF2) When N delay and R delay are bypassed
Phase Offset (REF-to-LVDS Clock Output Pins) in Internal Zero Delay Mode	900	1217	1695	ps	When N delay = Setting 111 and R delay is bypassed
Phase Offset (REF-to-CLK Input Pins) in External Zero Delay Mode	318	677	1085	ps	When N delay and R delay are bypassed
Phase Offset (REF-to-CLK Input Pins) in External Zero Delay Mode	-329	+33	+360	ps	When N delay = Setting 011 and R delay is bypassed
<b>NOISE CHARACTERISTICS</b>					
In-Band Phase Noise of the Charge Pump/ Phase Frequency Detector (In-Band Means Within the LBW of the PLL)					The PLL in-band phase noise floor is estimated by measuring the in-band phase noise at the output of the VCO and subtracting 20 log(N) (where N is the value of the N divider)
@ 500 kHz PFD Frequency		-165		dBc/Hz	
@ 1 MHz PFD Frequency		-162		dBc/Hz	
@ 10 MHz PFD Frequency		-152		dBc/Hz	
@ 50 MHz PFD Frequency		-144		dBc/Hz	
PLL Figure of Merit (FOM)		-222		dBc/Hz	Reference slew rate > 0.5 V/ns; FOM + 10 log( $f_{\text{PFD}}$ ) is an approximation of the PFD/CP in-band phase noise (in the flat region) inside the PLL loop bandwidth; when running closed-loop, the phase noise, as observed at the VCO output, is increased by 20 log(N); PLL figure of merit decreases with decreasing slew rate; see Figure 12
<b>PLL DIGITAL LOCK DETECT WINDOW<sup>2</sup></b>					
Lock Threshold (Coincidence of Edges)					Signal available at the LD, STATUS, and REFMON pins when selected by appropriate register settings; lock detect window settings can be varied by changing the CPRSET resistor
Low Range (ABP 1.3 ns, 2.9 ns)		3.5		ns	Selected by 0x017[1:0] and 0x018[4] (this is the threshold to go from unlock to lock)
High Range (ABP 1.3 ns, 2.9 ns)		7.5		ns	0x017[1:0] = 00b, 01b, 11b; 0x018[4] = 1b
High Range (ABP 6.0 ns)		3.5		ns	0x017[1:0] = 00b, 01b, 11b; 0x018[4] = 0b
Unlock Threshold (Hysteresis) <sup>2</sup>					Selected by 0x017[1:0] and 0x018[4] (this is the threshold to go from lock to unlock)
Low Range (ABP 1.3 ns, 2.9 ns)		7		ns	0x017[1:0] = 00b, 01b, 11b; 0x018[4] = 1b
High Range (ABP 1.3 ns, 2.9 ns)		15		ns	0x017[1:0] = 00b, 01b, 11b; 0x018[4] = 0b
High Range (ABP 6.0 ns)		11		ns	0x017[1:0] = 10b; 0x018[4] = 0b

<sup>1</sup> The REF $\overline{\text{IN}}$  and  $\overline{\text{REFIN}}$  self-bias points are offset slightly to avoid chatter on an open input condition.

<sup>2</sup> For reliable operation of the digital lock detect, the period of the PFD frequency must be greater than the unlock-after-lock time.

## CLOCK INPUTS

Table 3.

Parameter	Min	Typ	Max	Unit	Test Conditions/Comments
CLOCK INPUTS (CLK, $\overline{\text{CLK}}$ )					
Input Frequency	0 <sup>1</sup>		2.4	GHz	Differential input
	0 <sup>1</sup>		1.6	GHz	High frequency distribution (VCO divider)
Input Sensitivity, Differential		150		mV p-p	Distribution only (VCO divider bypassed); this is the frequency range supported by the channel divider
Input Level, Differential			2	V p-p	Measured at 2.4 GHz; jitter performance is improved with slew rates > 1 V/ns
Input Common-Mode Voltage, $V_{\text{CM}}$	1.3	1.57	1.8	V	Larger voltage swings can turn on the protection diodes and can degrade jitter performance
Input Common-Mode Range, $V_{\text{CMR}}$	1.3		1.8	V	Self-biased; enables ac coupling
Input Sensitivity, Single-Ended		150		mV p-p	With 200 mV p-p signal applied; dc-coupled
Input Resistance	3.9	4.7	5.7	k $\Omega$	CLK ac-coupled; $\overline{\text{CLK}}$ ac-bypassed to RF ground
Input Capacitance		2		pF	Self-biased

<sup>1</sup> Below about 1 MHz, the input should be dc-coupled. Care should be taken to match  $V_{\text{CM}}$ .

## CLOCK OUTPUTS

Table 4.

Parameter	Min	Typ	Max	Unit	Test Conditions/Comments
LVDS CLOCK OUTPUTS					
OUT0, OUT1, OUT2, OUT3, OUT4, OUT5, OUT6, OUT7, OUT8, OUT9, OUT10, OUT11					Termination = 100 $\Omega$ across differential pair
Output Frequency, Maximum	800			MHz	Differential (OUT, $\overline{\text{OUT}}$ )
Output Differential Voltage, $V_{\text{OD}}$	247	360	454	mV	The AD9522 outputs toggle at higher frequencies, but the output amplitude may not meet the $V_{\text{OD}}$ specification
Delta $V_{\text{OD}}$			25	mV	See Figure 21
Output Offset Voltage, $V_{\text{OS}}$	1.125	1.25	1.375	V	
Delta $V_{\text{OS}}$			25	mV	
Short-Circuit Current, $I_{\text{SA}}$ , $I_{\text{SB}}$		14	24	mA	Output shorted to GND
CMOS CLOCK OUTPUTS					
OUT0A, OUT0B, OUT1A, OUT1B, OUT2A, OUT2B, OUT3A, OUT3B, OUT4A, OUT4B, OUT5A, OUT5B, OUT6A, OUT6B, OUT7A, OUT7B, OUT8A, OUT8B, OUT9A, OUT9B, OUT10A, OUT10B, OUT11A, OUT11B					Single-ended; termination = 10 pF
Output Frequency			250	MHz	See Figure 22
Output Voltage High, $V_{\text{OH}}$	VS - 0.1			V	@ 1 mA load
Output Voltage Low, $V_{\text{OL}}$			0.1	V	@ 1 mA load
Output Voltage High, $V_{\text{OH}}$	2.7			V	@ 10 mA load
Output Voltage Low, $V_{\text{OL}}$			0.5	V	@ 10 mA load

# AD9522-4

## TIMING CHARACTERISTICS

Table 5.

Parameter	Min	Typ	Max	Unit	Test Conditions/Comments
<b>LVDS OUTPUT RISE/FALL TIMES</b>					
Output Rise Time, $t_{RP}$		150	350	ps	Termination = 100 $\Omega$ across differential pair 20% to 80%, measured differentially
Output Fall Time, $t_{FP}$		150	350	ps	
<b>PROPAGATION DELAY, <math>t_{LVDS}</math>, CLK-TO-LVDS OUTPUT</b>					
For All Divide Values	1866	2313	2812	ps	High frequency clock distribution configuration Clock distribution configuration
Variation with Temperature	1808	2245	2740	ps	
		1		ps/ $^{\circ}$ C	
<b>OUTPUT SKEW, LVDS OUTPUTS<sup>1</sup></b>					
LVDS Outputs That Share the Same Divider		7	60	ps	Termination = 100 $\Omega$ across differential pair
LVDS Outputs on Different Dividers		19	162	ps	
All LVDS Outputs Across Multiple Parts			432	ps	
<b>CMOS OUTPUT RISE/FALL TIMES</b>					
Output Rise Time, $t_{RC}$		625	835	ps	Termination = open 20% to 80%; $C_{LOAD} = 10$ pF
Output Fall Time, $t_{FC}$		625	800	ps	
<b>PROPAGATION DELAY, <math>t_{CMOS}</math>, CLK-TO-CMOS OUTPUT</b>					
For All Divide Values	1913	2400	2950	ps	Clock distribution configuration
Variation with Temperature		2		ps/ $^{\circ}$ C	
<b>OUTPUT SKEW, CMOS OUTPUTS<sup>1</sup></b>					
CMOS Outputs That Share the Same Divider		10	55	ps	
All CMOS Outputs on Different Dividers		27	230	ps	
All CMOS Outputs Across Multiple Parts			500	ps	
<b>OUTPUT SKEW, LVDS-TO-CMOS OUTPUT<sup>1</sup></b>					
Outputs That Share the Same Divider	-31	+152	+495	ps	All settings identical; different logic type LVDS to CMOS on the same part
Outputs That Are on Different Dividers	-193	+160	+495	ps	

<sup>1</sup> The output skew is the difference between any two similar delay paths while operating at the same voltage and temperature.

### Timing Diagrams

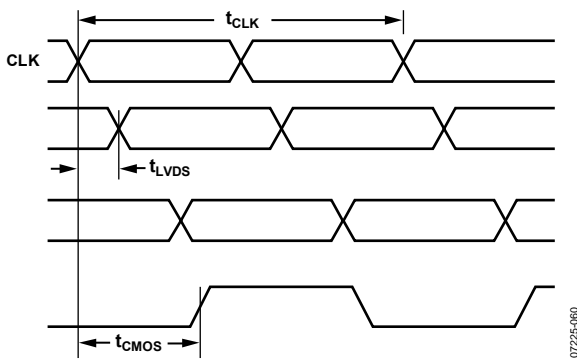

Figure 2. CLK/ $\overline{\text{CLK}}$  to Clock Output Timing, DIV = 1

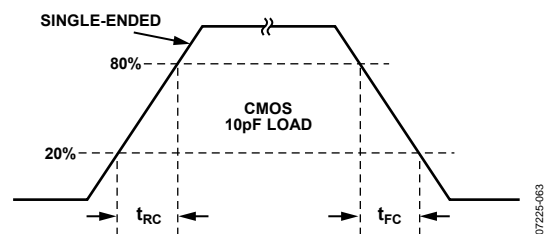

Figure 4. CMOS Timing, Single-Ended, 10 pF Load

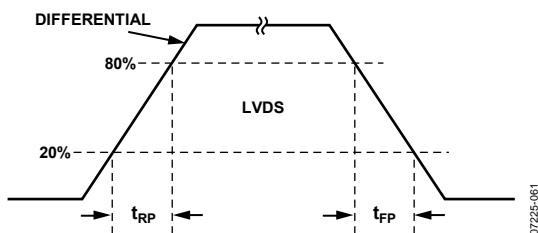

Figure 3. LVDS Timing, Differential



**CLOCK OUTPUT ADDITIVE PHASE NOISE (DISTRIBUTION ONLY; VCO DIVIDER NOT USED)**

Table 6.

Parameter	Min	Typ	Max	Unit	Test Conditions/Comments
CLK-TO-LVDS ADDITIVE PHASE NOISE CLK = 1.6 GHz, Output = 800 MHz Divider = 2					Distribution section only; does not include PLL and VCO Input slew rate > 1 V/ns
@ 10 Hz Offset		-100		dBc/Hz	
@ 100 Hz Offset		-110		dBc/Hz	
@ 1 kHz Offset		-117		dBc/Hz	
@ 10 kHz Offset		-126		dBc/Hz	
@ 100 kHz Offset		-134		dBc/Hz	
@ 1 MHz Offset		-137		dBc/Hz	
@ 10 MHz Offset		-147		dBc/Hz	
@ 100 MHz Offset		-148		dBc/Hz	
CLK = 1 GHz, Output = 200 MHz Divider = 5					Input slew rate > 1 V/ns
@ 10 Hz Offset		-111		dBc/Hz	
@ 100 Hz Offset		-123		dBc/Hz	
@ 1 kHz Offset		-132		dBc/Hz	
@ 10 kHz Offset		-141		dBc/Hz	
@ 100 kHz Offset		-146		dBc/Hz	
@ 1 MHz Offset		-150		dBc/Hz	
>10 MHz Offset		-156		dBc/Hz	
CLK-TO-CMOS ADDITIVE PHASE NOISE CLK = 1 GHz, Output = 500 MHz Divider = 2					Distribution section only; does not include PLL and VCO Input slew rate > 1 V/ns
@ 10 Hz Offset		-102		dBc/Hz	
@ 100 Hz Offset		-114		dBc/Hz	
@ 1 kHz Offset		-122		dBc/Hz	
@ 10 kHz Offset		-129		dBc/Hz	
@ 100 kHz Offset		-135		dBc/Hz	
@ 1 MHz Offset		-140		dBc/Hz	
>10 MHz Offset		-150		dBc/Hz	
CLK = 1 GHz, Output = 50 MHz Divider = 20					Input slew rate > 1 V/ns
@ 10 Hz Offset		-125		dBc/Hz	
@ 100 Hz Offset		-136		dBc/Hz	
@ 1 kHz Offset		-144		dBc/Hz	
@ 10 kHz Offset		-152		dBc/Hz	
@ 100 kHz Offset		-157		dBc/Hz	
@ 1 MHz Offset		-160		dBc/Hz	
>10 MHz Offset		-164		dBc/Hz	

# AD9522-4

## CLOCK OUTPUT ABSOLUTE PHASE NOISE (INTERNAL VCO USED)

Table 7.

Parameter	Min	Typ	Max	Unit	Test Conditions/Comments
LVDS ABSOLUTE PHASE NOISE					Internal VCO; VCO divider = 3; LVDS output and for loop bandwidths < 1 kHz
VCO = 1.8 GHz; Output = 600 MHz					
@ 1 kHz Offset		-64		dBc/Hz	
@ 10 kHz Offset		-93		dBc/Hz	
@ 100 kHz Offset		-116		dBc/Hz	
@ 1 MHz Offset		-135		dBc/Hz	
@ 10 MHz Offset		-148		dBc/Hz	
@ 40 MHz Offset		-151		dBc/Hz	
VCO = 1.6 GHz; Output = 533 MHz					
@ 1 kHz Offset		-66		dBc/Hz	
@ 10 kHz Offset		-96		dBc/Hz	
@ 100 kHz Offset		-120		dBc/Hz	
@ 1 MHz Offset		-137		dBc/Hz	
@ 10 MHz Offset		-149		dBc/Hz	
@ 40 MHz Offset		-151		dBc/Hz	
VCO = 1.4 GHz; Output = 467 MHz					
@ 1 kHz Offset		-71		dBc/Hz	
@ 10 kHz Offset		-101		dBc/Hz	
@ 100 kHz Offset		-124		dBc/Hz	
@ 1 MHz Offset		-140		dBc/Hz	
@ 10 MHz Offset		-150		dBc/Hz	
@ 40 MHz Offset		-152		dBc/Hz	

## CLOCK OUTPUT ABSOLUTE TIME JITTER (CLOCK GENERATION USING INTERNAL VCO)

Table 8.

Parameter	Min	Typ	Max	Unit	Test Conditions/Comments
LVDS OUTPUT ABSOLUTE TIME JITTER					Application example based on a typical setup where the reference source is clean, so a wider PLL loop bandwidth is used; reference = 15.36 MHz; R DIV = 1
VCO = 1475 MHz; LVDS = 245.76 MHz; PLL LBW = 55 kHz		127		fs rms	Integration BW = 200 kHz to 10 MHz
		285		fs rms	Integration BW = 12 kHz to 20 MHz
VCO = 1475 MHz; LVDS = 122.88 MHz; PLL LBW = 55 kHz		145		fs rms	Integration BW = 200 kHz to 10 MHz
		299		fs rms	Integration BW = 12 kHz to 20 MHz
VCO = 1475 MHz; LVDS = 61.44 MHz; PLL LBW = 55 kHz		194		fs rms	Integration BW = 200 kHz to 10 MHz
		351		fs rms	Integration BW = 12 kHz to 20 MHz

## CLOCK OUTPUT ABSOLUTE TIME JITTER (CLOCK CLEANUP USING INTERNAL VCO)

Table 9.

Parameter	Min	Typ	Max	Unit	Test Conditions/Comments
LVDS OUTPUT ABSOLUTE TIME JITTER					Application example based on a typical setup where the reference source is jittery, so a narrower PLL loop bandwidth is used; reference = 19.44 MHz; R DIV = 162
VCO = 1400 MHz; LVDS = 155.52 MHz; PLL LBW = 1.8 kHz		372		fs rms	Integration BW = 12 kHz to 20 MHz
VCO = 1475 MHz; LVDS = 122.88 MHz; PLL LBW = 1.8 kHz		418		fs rms	Integration BW = 12 kHz to 20 MHz

**CLOCK OUTPUT ABSOLUTE TIME JITTER (CLOCK GENERATION USING EXTERNAL VCXO)**

Table 10.

Parameter	Min	Typ	Max	Unit	Test Conditions/Comments
LVDS OUTPUT ABSOLUTE TIME JITTER					Application example based on a typical setup using an external 245.76 MHz VCXO (Toyocom TCO-2112); reference = 15.36 MHz; R DIV = 1
LVDS = 245.76 MHz; PLL LBW = 125 Hz		87		fs rms	Integration BW = 200 kHz to 5 MHz
		108		fs rms	Integration BW = 200 kHz to 10 MHz
		146		fs rms	Integration BW = 12 kHz to 20 MHz
LVDS = 122.88 MHz; PLL LBW = 125 Hz		120		fs rms	Integration BW = 200 kHz to 5 MHz
		151		fs rms	Integration BW = 200 kHz to 10 MHz
		207		fs rms	Integration BW = 12 kHz to 20 MHz
LVDS = 61.44 MHz; PLL LBW = 125 Hz		157		fs rms	Integration BW = 200 kHz to 5 MHz
		210		fs rms	Integration BW = 200 kHz to 10 MHz
		295		fs rms	Integration BW = 12 kHz to 20 MHz

**CLOCK OUTPUT ADDITIVE TIME JITTER (VCO DIVIDER NOT USED)**

Table 11.

Parameter	Min	Typ	Max	Unit	Test Conditions/Comments
LVDS OUTPUT ADDITIVE TIME JITTER					Distribution section only; does not include PLL and VCO; measured at rising edge of clock signal
CLK = 622.08 MHz Any LVDS Output = 622.08 MHz Divide Ratio = 1		69		fs rms	Integration bandwidth = 12 kHz to 20 MHz
CLK = 622.08 MHz Any LVDS Output = 155.52 MHz Divide Ratio = 4		116		fs rms	Integration bandwidth = 12 kHz to 20 MHz
CLK = 100 MHz Any LVDS Output = 100 MHz Divide Ratio = 1		263		fs rms	Calculated from SNR of ADC method Broadband jitter
CLK = 500 MHz Any LVDS Output = 100 MHz Divide Ratio = 5		242		fs rms	Calculated from SNR of ADC method Broadband jitter
CMOS OUTPUT ADDITIVE TIME JITTER					Distribution section only; does not include PLL and VCO
CLK = 200 MHz Any CMOS Output Pair = 100 MHz Divide Ratio = 2		289		fs rms	Calculated from SNR of ADC method Broadband jitter

# AD9522-4

## CLOCK OUTPUT ADDITIVE TIME JITTER (VCO DIVIDER USED)

Table 12.

Parameter	Min	Typ	Max	Unit	Test Conditions/Comments
LVDS OUTPUT ADDITIVE TIME JITTER  CLK = 500 MHz; VCO DIV = 5; LVDS = 100 MHz; Bypass Channel Divider; Duty-Cycle Correction = On		248		fs rms	Distribution section only; does not include PLL and VCO; uses rising edge of clock signal Calculated from SNR of ADC method (broadband jitter)
CMOS OUTPUT ADDITIVE TIME JITTER  CLK = 200 MHz; VCO DIV = 2; CMOS = 100 MHz; Bypass Channel Divider; Duty-Cycle Correction = Off		290		fs rms	Distribution section only; does not include PLL and VCO; uses rising edge of clock signal Calculated from SNR of ADC method (broadband jitter)
CLK = 200 MHz; VCO DIV = 1; CMOS = 100 MHz; Bypass Channel Divider; Duty-Cycle Correction = Off		288		fs rms	Calculated from SNR of ADC method (broadband jitter)

## SERIAL CONTROL PORT—SPI MODE

Table 13.

Parameter	Min	Typ	Max	Unit	Test Conditions/Comments
$\overline{\text{CS}}$ (INPUT)  Input Logic 1 Voltage Input Logic 0 Voltage Input Logic 1 Current Input Logic 0 Current  Input Capacitance	2.0		0.8 3	V V $\mu\text{A}$ $\mu\text{A}$	$\overline{\text{CS}}$ has an internal 30 k $\Omega$ pull-up resistor  The minus sign indicates that current is flowing out of the AD9522, which is due to the internal pull-up resistor
		-110		$\mu\text{A}$	
SCLK (INPUT) IN SPI MODE  Input Logic 1 Voltage Input Logic 0 Voltage Input Logic 1 Current Input Logic 0 Current Input Capacitance	2.0		0.8 110 1	V V $\mu\text{A}$ $\mu\text{A}$	SCLK has an internal 30 k $\Omega$ pull-down resistor in SPI mode, but not in I <sup>2</sup> C mode
		2		$\mu\text{A}$ pF	
SDIO (WHEN AN INPUT IN BIDIRECTIONAL MODE)  Input Logic 1 Voltage Input Logic 0 Voltage Input Logic 1 Current Input Logic 0 Current Input Capacitance	2.0		0.8 1 1	V V $\mu\text{A}$ $\mu\text{A}$	
		2		$\mu\text{A}$ pF	
SDIO, SDO (OUTPUTS)  Output Logic 1 Voltage Output Logic 0 Voltage	2.7		0.4	V V	
TIMING  Clock Rate (SCLK, 1/ $t_{\text{SCLK}}$ ) Pulse Width High, $t_{\text{HIGH}}$ Pulse Width Low, $t_{\text{LOW}}$ SDIO to SCLK Setup, $t_{\text{DS}}$ SCLK to SDIO Hold, $t_{\text{DH}}$ SCLK to Valid SDIO and SDO, $t_{\text{DV}}$ $\overline{\text{CS}}$ to SCLK Setup and Hold, $t_{\text{S}}$ , $t_{\text{C}}$ $\overline{\text{CS}}$ Minimum Pulse Width High, $t_{\text{PWH}}$			25 16 16 4 0 11 2 3	MHz ns ns ns ns ns ns ns	

SERIAL CONTROL PORT—I<sup>2</sup>C MODE

Table 14.

Parameter	Min	Typ	Max	Unit	Test Conditions/Comments
SDA, SCL (WHEN INPUTTING DATA)					
Input Logic 1 Voltage	$0.7 \times VS$			V	
Input Logic 0 Voltage			$0.3 \times VS$	V	
Input Current with an Input Voltage Between $0.1 \times VS$ and $0.9 \times VS$	-10		+10	$\mu A$	
Hysteresis of Schmitt Trigger Inputs	$0.015 \times VS$			V	
Pulse Width of Spikes That Must Be Suppressed by the Input Filter, $t_{SPIKE}$			50	ns	
SDA (WHEN OUTPUTTING DATA)					
Output Logic 0 Voltage at 3 mA Sink Current			0.4	V	
Output Fall Time from $V_{IH_{MIN}}$ to $V_{IL_{MAX}}$ with a Bus Capacitance from 10 pF to 400 pF	$20 + 0.1 C_b$		250	ns	$C_b$ = capacitance of one bus line in pF
TIMING					
Clock Rate (SCL, $f_{I2C}$ )			400	kHz	Note that all I <sup>2</sup> C timing values refer to $V_{IH_{MIN}}$ ( $0.3 \times VS$ ) and $V_{IL_{MAX}}$ levels ( $0.7 \times VS$ )  This is a minor deviation from the original I <sup>2</sup> C specification of 100 ns minimum  This is a minor deviation from the original I <sup>2</sup> C specification of 0 ns minimum <sup>1</sup>
Bus Free Time Between a Stop and Start Condition, $t_{IDLE}$	1.3			$\mu s$	
Setup Time for a Repeated Start Condition, $t_{SET;STR}$	0.6			$\mu s$	
Hold Time (Repeated) Start Condition (After This Period, the First Clock Pulse Is Generated), $t_{HLD;STR}$	0.6			$\mu s$	
Setup Time for Stop Condition, $t_{SET;STP}$	0.6			$\mu s$	
Low Period of the SCL Clock, $t_{LOW}$	1.3			$\mu s$	
High Period of the SCL Clock, $t_{HIGH}$	0.6			$\mu s$	
SCL, SDA Rise Time, $t_{RISE}$	$20 + 0.1 C_b$		300	ns	
SCL, SDA Fall Time, $t_{FALL}$	$20 + 0.1 C_b$		300	ns	
Data Setup Time, $t_{SET;DAT}$	120			ns	
Data Hold Time, $t_{HLD;DAT}$	140		880	ns	
Capacitive Load for Each Bus Line, $C_b$			400	pF	

<sup>1</sup> According to the original I<sup>2</sup>C specification, an I<sup>2</sup>C master must also provide a minimum hold time of 300 ns for the SDA signal to bridge the undefined region of the SCL falling edge.

# AD9522-4

## PD, SYNC, AND RESET PINS

Table 15.

Parameter	Min	Typ	Max	Unit	Test Conditions/Comments
INPUT CHARACTERISTICS					Each of these pins has a 30 kΩ internal pull-up resistor
Logic 1 Voltage	2.0			V	The minus sign indicates that current is flowing out of the AD9522, which is due to the internal pull-up resistor
Logic 0 Voltage			0.8	V	
Logic 1 Current			1	μA	
Logic 0 Current			-110	μA	
Capacitance		2		pF	
RESET TIMING					
Pulse Width Low	50			ns	
RESET Inactive to Start of Register Programming	100			ns	
SYNC TIMING					
Pulse Width Low	1.3			ns	High speed clock is CLK input signal

## SERIAL PORT SETUP PINS: SP1, SP0

Table 16.

Parameter	Min	Typ	Max	Unit	Test Conditions/Comments
SP1, SP0					These pins do not have internal pull-up/pull-down resistors
Logic Level 0			$0.25 \times VS$	V	VS is the voltage on the VS pin
Logic Level ½	$0.4 \times VS$		$0.65 \times VS$	V	User can float these pins to obtain Logic Level ½; if floating this pin, user should connect a capacitor to ground
Logic Level 1	$0.8 \times VS$			V	

## LD, STATUS, AND REFMON PINS

Table 17.

Parameter	Min	Typ	Max	Unit	Test Conditions/Comments
OUTPUT CHARACTERISTICS					When selected as a digital output (CMOS); there are other modes in which these pins are not CMOS digital outputs; see Table 52, 0x017, 0x01A, and 0x01B
Output Voltage High, $V_{OH}$	2.7			V	
Output Voltage Low, $V_{OL}$			0.4	V	
MAXIMUM TOGGLE RATE		100		MHz	Applies when mux is set to any divider or counter output, or PFD up/down pulse; also applies in analog lock detect mode; usually debug mode only; beware that spurs can couple to output when any of these pins are toggling
ANALOG LOCK DETECT					
Capacitance		3		pF	On-chip capacitance; used to calculate RC time constant for analog lock detect readback; use a pull-up resistor
REF1, REF2, AND VCO FREQUENCY STATUS MONITOR					
Normal Range	1.02			MHz	Frequency above which the monitor indicates the presence of the reference
Extended Range	8			kHz	Frequency above which the monitor indicates the presence of the reference
LD PIN COMPARATOR					
Trip Point		1.6		V	
Hysteresis		260		mV	

## POWER DISSIPATION

Table 18.

Parameter	Min	Typ	Max	Unit	Test Conditions/Comments
POWER DISSIPATION, CHIP					Does not include power dissipated in external resistors; all LVDS outputs terminated with 100 $\Omega$ across differential pair; all CMOS outputs have 10 pF capacitive loading
Power-On Default		0.88	1.0	W	No clock; no programming; default register values
PLL Locked; One LVDS Output Enabled		0.54	0.63	W	$f_{REF} = 25$ MHz; $f_{OUT} = 250$ MHz; VCO = 1500 MHz; VCO divider = 2; one LVDS output and output divider enabled; zero delay off; $I_{CP} = 4.8$ mA
PLL Locked; One CMOS Output Enabled		0.55	0.66	W	$f_{REF} = 25$ MHz; $f_{OUT} = 62.5$ MHz; VCO = 1500 MHz; VCO divider = 2; one CMOS output and output divider enabled; zero delay off; $I_{CP} = 4.8$ mA
Distribution Only Mode; VCO Divider On; One LVDS Output Enabled		0.36	0.43	W	$f_{CLK} = 2.4$ GHz; $f_{OUT} = 200$ MHz; VCO divider = 2; one LVDS output and output divider enabled; zero delay off
Distribution Only Mode; VCO Divider Off; One LVDS Output Enabled		0.33	0.4	W	$f_{CLK} = 2.4$ GHz; $f_{OUT} = 200$ MHz; VCO divider bypassed; one LVDS output and output divider enabled; zero delay off
Maximum Power, Full Operation		1.1	1.3	W	PLL on; internal VCO = 1500 MHz; VCO divider = 2; all channel dividers on; 12 LVDS outputs @ 125 MHz; zero delay on
$\overline{PD}$ Power-Down		35	50	mW	$\overline{PD}$ pin pulled low; does not include power dissipated in termination resistors
$\overline{PD}$ Power-Down, Maximum Sleep		27	43	mW	$\overline{PD}$ pin pulled low; PLL power-down, 0x010[1:0] = 01b; power-down SYNC, 0x230[2] = 1b; power-down distribution reference, 0x230[1] = 1b
VCP Supply		8	2.3	mW	PLL operating; typical closed-loop configuration
POWER DELTAS, INDIVIDUAL FUNCTIONS					Power delta when a function is enabled/disabled
VCO Divider On/Off		33	43	mW	VCO divider not used
REFIN (Differential) Off		25	31	mW	Delta between reference input off and differential reference input mode
REF1, REF2 (Single-Ended) On/Off		16	22	mW	Delta between reference inputs off and one singled-ended reference enabled; double this number if both REF1 and REF2 are powered up
VCO On/Off		60	95	mW	Internal VCO disabled; CLK input selected
PLL Dividers and Phase Detector On/Off		54	67	mW	PLL off to PLL on, normal operation; no reference enabled
LVDS Channel		118	146	mW	No LVDS output on to one LVDS output on; channel divider set to 1
LVDS Driver		11	15	mW	Second LVDS output turned on, same channel
CMOS Channel		120	154	mW	No CMOS output on to one CMOS output on; channel divider set to 1; $f_{OUT} = 62.5$ MHz and 10 pF of capacitive loading
CMOS Driver On/Off		16	30	mW	Additional CMOS outputs within the same channel turned on
Channel Divider Enabled		33	40	mW	Delta between divider bypassed (divide-by-1) and divide-by-2 to divide-by-32
Zero Delay Block On/Off		30	35	mW	

## ABSOLUTE MAXIMUM RATINGS

Table 19.

Parameter or Pin	With Respect to	Rating
VS	GND	-0.3 V to +3.6 V
VCP, CP	GND	-0.3 V to +5.8 V
REFIN, $\overline{\text{REFIN}}$	GND	-0.3 V to VS + 0.3 V
RSET, LF, BYPASS	GND	-0.3 V to VS + 0.3 V
CPRSET	GND	-0.3 V to VS + 0.3 V
CLK, $\overline{\text{CLK}}$	GND	-0.3 V to VS + 0.3 V
CLK	$\overline{\text{CLK}}$	-1.2 V to +1.2 V
SCLK/SCL, SDIO/SDA, SDO, $\overline{\text{CS}}$	GND	-0.3 V to VS + 0.3 V
OUT0, $\overline{\text{OUT0}}$ , OUT1, $\overline{\text{OUT1}}$ , OUT2, $\overline{\text{OUT2}}$ , OUT3, $\overline{\text{OUT3}}$ , OUT4, $\overline{\text{OUT4}}$ , OUT5, $\overline{\text{OUT5}}$ , OUT6, $\overline{\text{OUT6}}$ , OUT7, $\overline{\text{OUT7}}$ , OUT8, $\overline{\text{OUT8}}$ , OUT9, $\overline{\text{OUT9}}$ , OUT10, $\overline{\text{OUT10}}$ , OUT11, $\overline{\text{OUT11}}$	GND	-0.3 V to VS + 0.3 V
$\overline{\text{SYNC}}$ , $\overline{\text{RESET}}$ , $\overline{\text{PD}}$	GND	-0.3 V to VS + 0.3 V
REFMON, STATUS, LD	GND	-0.3 V to VS + 0.3 V
SP0, SP1, EEPROM	GND	-0.3 V to VS + 0.3 V
Junction Temperature <sup>1</sup>		150°C
Storage Temperature Range		-65°C to +150°C
Lead Temperature (10 sec)		300°C

<sup>1</sup> See Table 20 for  $\theta_{JA}$ .

Stresses above those listed under Absolute Maximum Ratings may cause permanent damage to the device. This is a stress rating only; functional operation of the device at these or any other conditions above those indicated in the operational section of this specification is not implied. Exposure to absolute maximum rating conditions for extended periods may affect device reliability.

### THERMAL RESISTANCE

Thermal impedance measurements were taken on a JEDEC JESD51-5 2S2P test board in still air in accordance with JEDEC JESD51-2. See the Thermal Performance section for more details.

Table 20.

Package Type	$\theta_{JA}$	Unit
64-Lead LFCSP (CP-64-4)	22	°C/W

### ESD CAUTION



**ESD (electrostatic discharge) sensitive device.** Charged devices and circuit boards can discharge without detection. Although this product features patented or proprietary protection circuitry, damage may occur on devices subjected to high energy ESD. Therefore, proper ESD precautions should be taken to avoid performance degradation or loss of functionality.



# PIN CONFIGURATION AND FUNCTION DESCRIPTIONS

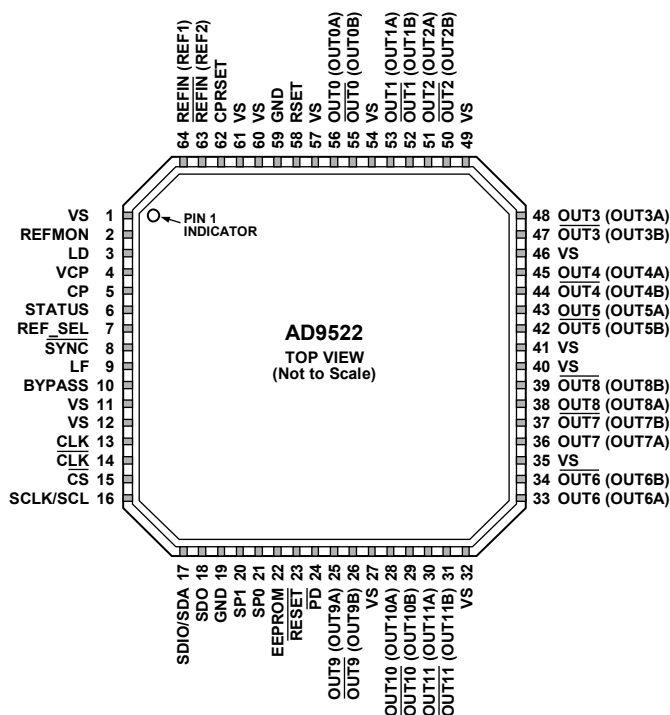

NOTES  
1. EXPOSED DIE PAD MUST BE CONNECTED TO GND.

Figure 5. Pin Configuration

07225-003

Table 21. Pin Function Descriptions

Pin No.	Input/Output	Pin Type	Mnemonic	Description
1, 11, 12, 27, 32, 35, 40, 41, 46, 49, 54, 57, 60, 61	I	Power	VS	3.3 V Power Pins.
2	O	3.3 V CMOS	REFMON	Reference Monitor (Output). This pin has multiple selectable outputs.
3	O	3.3 V CMOS	LD	Lock Detect (Output). This pin has multiple selectable outputs.
4	I	Power	VCP	Power Supply for Charge Pump (CP); $VS < VCP < 5.0V$ . VCP must still be connected to 3.3 V if the PLL is not used.
5	O	Loop filter	CP	Charge Pump (Output). This pin connects to an external loop filter. This pin can be left unconnected if the PLL is not used.
6	O	3.3 V CMOS	STATUS	Programmable Status Output.
7	I	3.3 V CMOS	REF_SEL	Reference Select. It selects REF1 (low) or REF2 (high). This pin has an internal 30 kΩ pull-down resistor.
8	I	3.3 V CMOS	SYNC	Manual Synchronizations and Manual Holdover. This pin initiates a manual synchronization and is used for manual holdover. Active low. This pin has an internal 30 kΩ pull-up resistor.
9	I	Loop filter	LF	Loop Filter (Input). It connects internally to the VCO control voltage node.
10	O	Loop filter	BYPASS	This pin is for bypassing the LDO to ground with a 220 nF capacitor. This pin can be left unconnected if the PLL is not used.
13	I	Differential clock input	CLK	Along with $\overline{CLK}$ , this pin is the differential input for the clock distribution section.
14	I	Differential clock input	$\overline{CLK}$	Along with CLK, this pin is the differential input for the clock distribution section. If a single-ended input is connected to the CLK pin, connect a 0.1 μF bypass capacitor from this pin to ground.

# AD9522-4

Pin No.	Input/Output	Pin Type	Mnemonic	Description
15	I	3.3 V CMOS	$\overline{CS}$	Serial Control Port Chip Select; Active Low. This pin has an internal 30 k $\Omega$ pull-up resistor.
16	I	3.3 V CMOS	SCLK/SCL	Serial Control Port Clock Signal. This pin has an internal 30 k $\Omega$ pull-down resistor in SPI mode but is high impedance in I <sup>2</sup> C mode.
17	I/O	3.3 V CMOS	SDIO/SDA	Serial Control Port Bidirectional Serial Data In/Out.
18	O	3.3 V CMOS	SDO	Serial Control Port Unidirectional Serial Data Out.
19, 59	I	GND	GND	Ground Pins.
20	I	Three-level logic	SP1	Select SPI or I <sup>2</sup> C as the serial interface port and select the I <sup>2</sup> C slave address in I <sup>2</sup> C mode. Three-level logic. This pin is internally biased for the open logic level.
21	I	Three-level logic	SP0	Select SPI or I <sup>2</sup> C as the serial interface port and select the I <sup>2</sup> C slave address in I <sup>2</sup> C mode. Three-level logic. This pin is internally biased for the open logic level.
22	I	3.3 V CMOS	EEPROM	Setting this pin high selects the register values stored in the internal EEPROM to be loaded at reset and/or power-up. Setting this pin low causes the AD9522 to load the hard-coded default register values at power-up/reset. This pin has an internal 30 k $\Omega$ pull-down resistor.
23	I	3.3 V CMOS	$\overline{RESET}$	Chip Reset, Active Low. This pin has an internal 30 k $\Omega$ pull-up resistor.
24	I	3.3 V CMOS	$\overline{PD}$	Chip Power-Down, Active Low. This pin has an internal 30 k $\Omega$ pull-up resistor.
25	O	LVDS or CMOS	OUT9 (OUT9A)	Clock Output. This pin can be configured as one side of a differential LVDS output or as a single-ended CMOS output.
26	O	LVDS or CMOS	$\overline{OUT9}$ (OUT9B)	Clock Output. This pin can be configured as one side of a differential LVDS output or as a single-ended CMOS output.
28	O	LVDS or CMOS	OUT10 (OUT10A)	Clock Output. This pin can be configured as one side of a differential LVDS output or as a single-ended CMOS output.
29	O	LVDS or CMOS	$\overline{OUT10}$ (OUT10B)	Clock Output. This pin can be configured as one side of a differential LVDS output or as a single-ended CMOS output.
30	O	LVDS or CMOS	OUT11 (OUT11A)	Clock Output. This pin can be configured as one side of a differential LVDS output or as a single-ended CMOS output.
31	O	LVDS or CMOS	$\overline{OUT11}$ (OUT11B)	Clock Output. This pin can be configured as one side of a differential LVDS output or as a single-ended CMOS output.
33	O	LVDS or CMOS	OUT6 (OUT6A)	Clock Output. This pin can be configured as one side of a differential LVDS output or as a single-ended CMOS output.
34	O	LVDS or CMOS	$\overline{OUT6}$ (OUT6B)	Clock Output. This pin can be configured as one side of a differential LVDS output or as a single-ended CMOS output.
36	O	LVDS or CMOS	OUT7 (OUT7A)	Clock Output. This pin can be configured as one side of a differential LVDS output or as a single-ended CMOS output.
37	O	LVDS or CMOS	$\overline{OUT7}$ (OUT7B)	Clock Output. This pin can be configured as one side of a differential LVDS output or as a single-ended CMOS output.
38	O	LVDS or CMOS	OUT8 (OUT8A)	Clock Output. This pin can be configured as one side of a differential LVDS output or as a single-ended CMOS output.
39	O	LVDS or CMOS	$\overline{OUT8}$ (OUT8B)	Clock Output. This pin can be configured as one side of a differential LVDS output or as a single-ended CMOS output.
42	O	LVDS or CMOS	$\overline{OUT5}$ (OUT5B)	Clock Output. This pin can be configured as one side of a differential LVDS output or as a single-ended CMOS output.
43	O	LVDS or CMOS	OUT5 (OUT5A)	Clock Output. This pin can be configured as one side of a differential LVDS output or as a single-ended CMOS output.
44	O	LVDS or CMOS	$\overline{OUT4}$ (OUT4B)	Clock Output. This pin can be configured as one side of a differential LVDS output or as a single-ended CMOS output.
45	O	LVDS or CMOS	OUT4 (OUT4A)	Clock Output. This pin can be configured as one side of a differential LVDS output or as a single-ended CMOS output.

Pin No.	Input/Output	Pin Type	Mnemonic	Description
47	O	LVDS or CMOS	$\overline{\text{OUT3}}$ (OUT3B)	Clock Output. This pin can be configured as one side of a differential LVDS output or as a single-ended CMOS output.
48	O	LVDS or CMOS	OUT3 (OUT3A)	Clock Output. This pin can be configured as one side of a differential LVDS output or as a single-ended CMOS output.
50	O	LVDS or CMOS	$\overline{\text{OUT2}}$ (OUT2B)	Clock Output. This pin can be configured as one side of a differential LVDS output or as a single-ended CMOS output.
51	O	LVDS or CMOS	OUT2 (OUT2A)	Clock Output. This pin can be configured as one side of a differential LVDS output or as a single-ended CMOS output.
52	O	LVDS or CMOS	$\overline{\text{OUT1}}$ (OUT1B)	Clock Output. This pin can be configured as one side of a differential LVDS output or as a single-ended CMOS output.
53	O	LVDS or CMOS	OUT1 (OUT1A)	Clock Output. This pin can be configured as one side of a differential LVDS output or as a single-ended CMOS output.
55	O	LVDS or CMOS	$\overline{\text{OUT0}}$ (OUT0B)	Clock Output. This pin can be configured as one side of a differential LVDS output or as a single-ended CMOS output.
56	O	LVDS or CMOS	OUT0 (OUT0A)	Clock Output. This pin can be configured as one side of a differential LVDS output or as a single-ended CMOS output.
58	O	Current set resistor	RSET	Clock Distribution Current Set Resistor. Connect a 4.12 k $\Omega$ resistor from this pin to GND.
62	O	Current set resistor	CPRSET	Charge Pump Current Set Resistor. Connect a 5.1 k $\Omega$ resistor from this pin to GND. This resistor can be omitted if the PLL is not used.
63	I	Reference input	$\overline{\text{REFIN}}$ (REF2)	Along with REF $\overline{\text{IN}}$ , this is the differential input for the PLL reference. Alternatively, this pin is a single-ended input for REF2.
64	I	Reference input	REFIN (REF1)	Along with $\overline{\text{REFIN}}$ , this is the differential input for the PLL reference. Alternatively, this pin is a single-ended input for REF1.
EPAD		GND	GND	The exposed die pad must be connected to GND.

TYPICAL PERFORMANCE CHARACTERISTICS



07225-108

Figure 6. Total Current vs. Frequency, CLK-to-Output (PLL Off), Channel and VCO Divider Bypassed, LVDS Outputs Terminated 100Ω Across Differential Pair

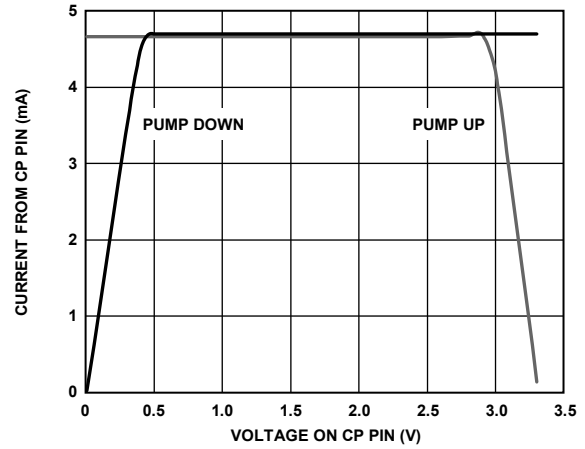

07225-111

Figure 9. Charge Pump Characteristics @ VCP = 3.3 V

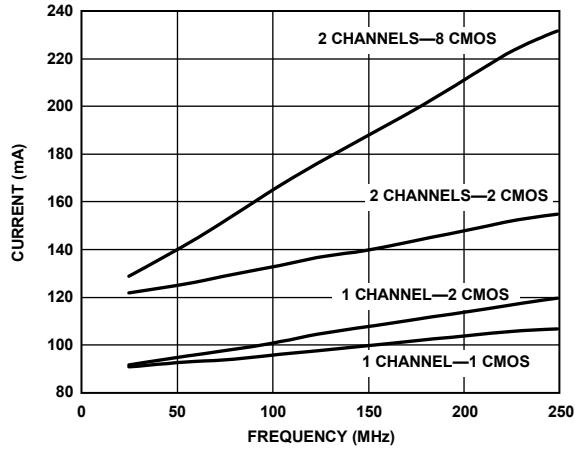

07225-109

Figure 7. Total Current vs. Frequency, CLK-to-Output (PLL Off), Channel and VCO Divider Bypassed, CMOS Outputs with 10 pF Load

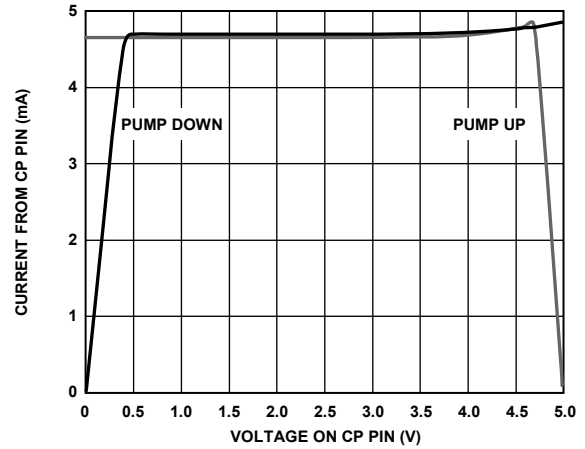

07225-112

Figure 10. Charge Pump Characteristics @ VCP = 5.0 V

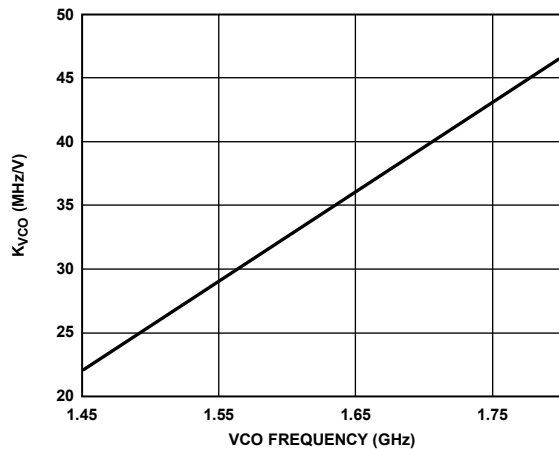

07225-010

Figure 8.  $K_{VCO}$  vs. VCO Frequency

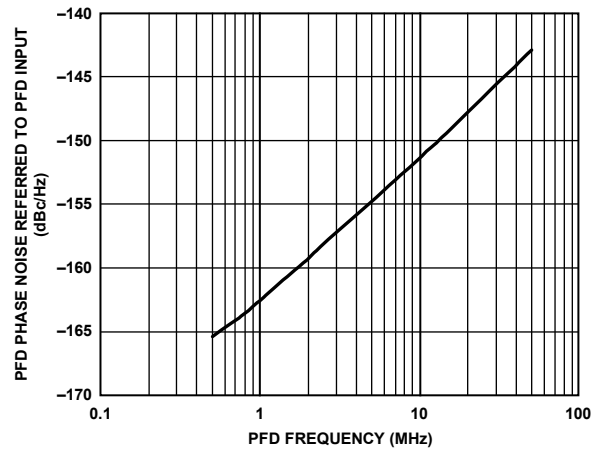

07225-013

Figure 11. PFD Phase Noise Referred to PFD Input vs. PFD Frequency

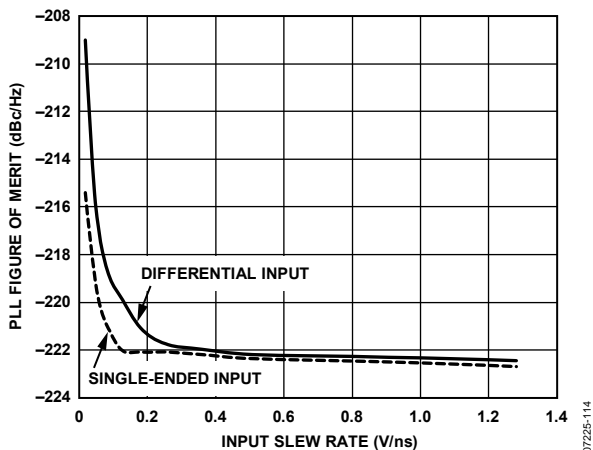

Figure 12. PLL Figure of Merit (FOM) vs. Slew Rate at REFIN/REFIN

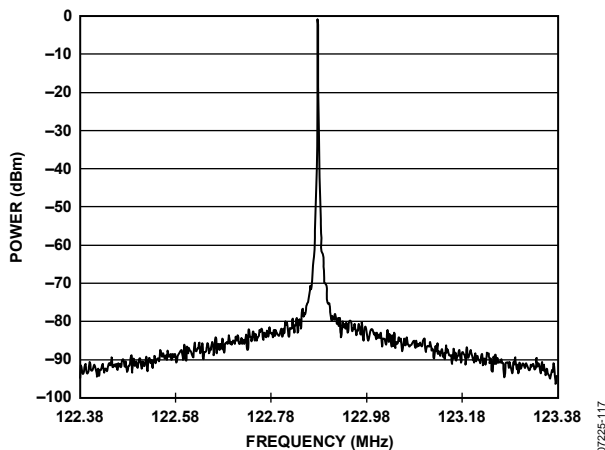

Figure 15. Output Spectrum, LVDS; 122.88 MHz; PFD = 15.36 MHz; LBW = 127 kHz;  $I_{CP} = 3.0$  mA;  $f_{VCO} = 1475$  MHz

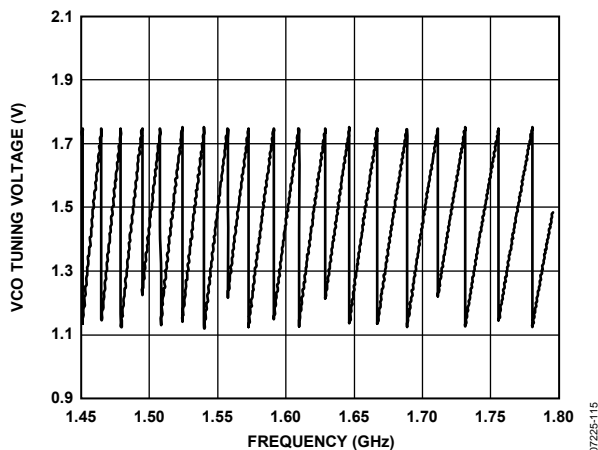

Figure 13. VCO Tuning Voltage vs. Frequency

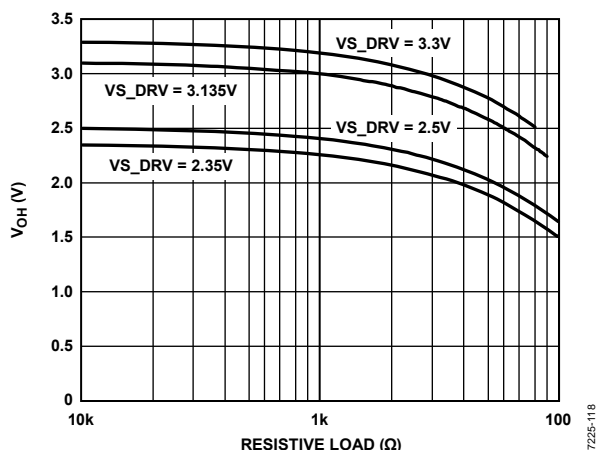

Figure 16. CMOS Output  $V_{OH}$  (Static) vs.  $R_{LOAD}$  (to Ground)

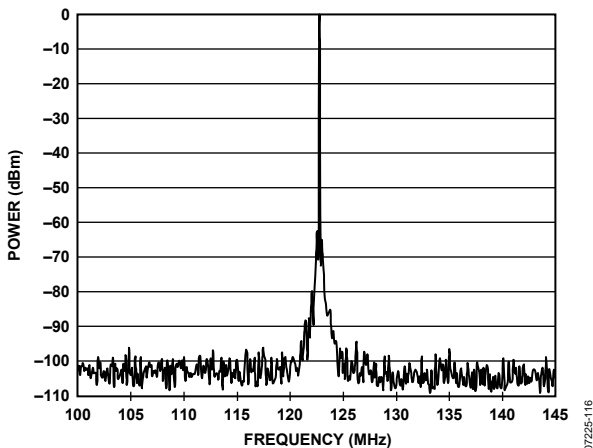

Figure 14. PFD/CP Spurs; 122.88 MHz; PFD = 15.36 MHz; LBW = 127 kHz;  $I_{CP} = 3.0$  mA;  $f_{VCO} = 1475$  MHz

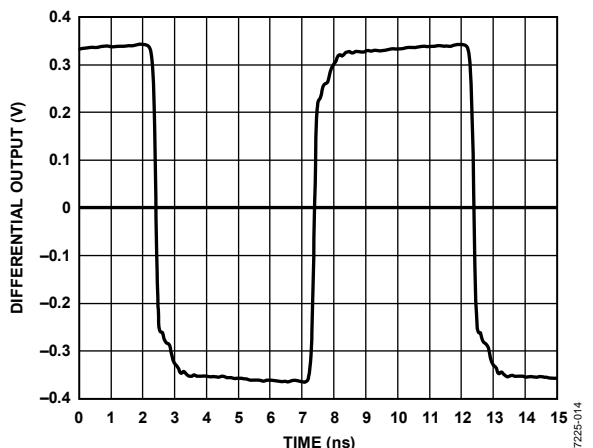

Figure 17. LVDS Output (Differential) @ 100 MHz Output Terminated 100  $\Omega$  Across Differential Pair

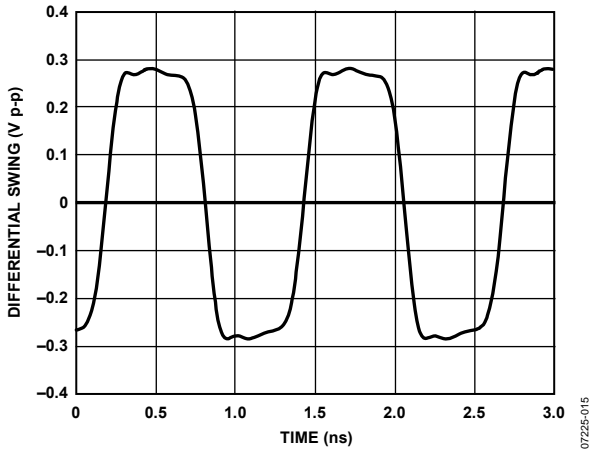

Figure 18. LVDS Differential Voltage Swing @ 800 MHz Output Terminated 100 Ω Across Differential Pair

07225-015

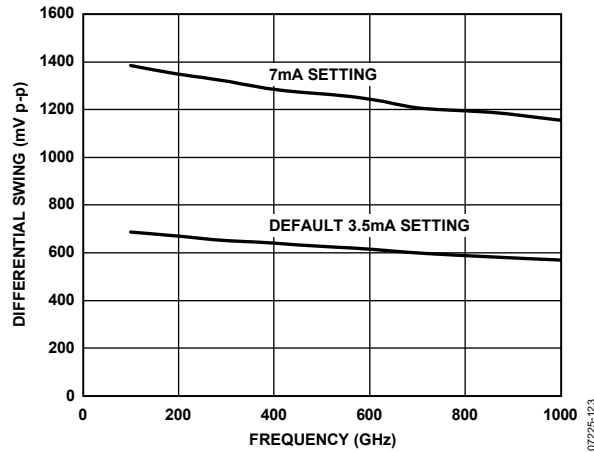

Figure 21. LVDS Differential Voltage Swing vs. Frequency Output Terminated 100 Ω Across Differential Pair

07225-123

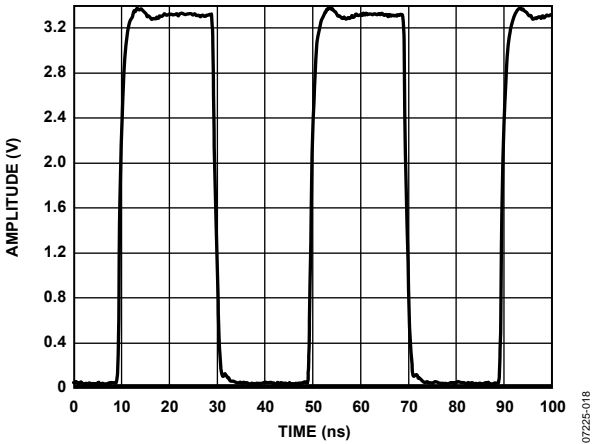

Figure 19. CMOS Output with 10 pF Load @ 25 MHz

07225-018

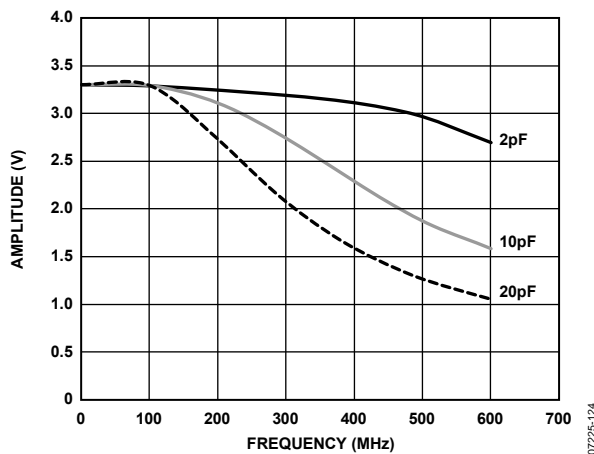

Figure 22. CMOS Output Swing vs. Frequency and Capacitive Load

07225-124

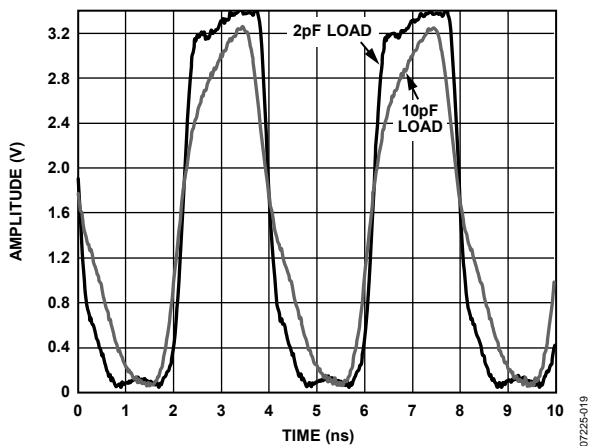

Figure 20. CMOS Output with 2 pF and 10 pF Load @ 250 MHz

07225-019

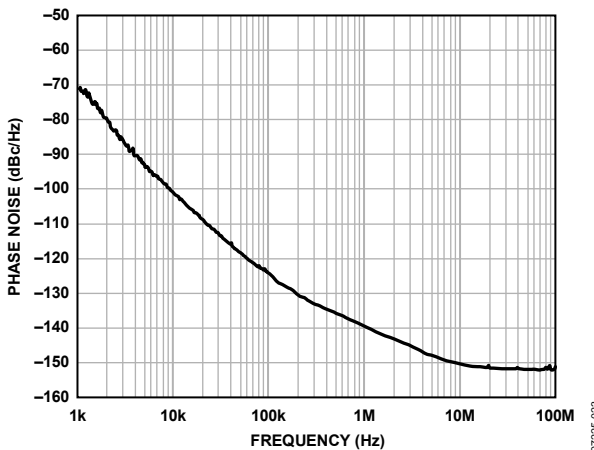

Figure 23. Internal VCO Phase Noise (Absolute), LVDS Output @ 467 MHz

07225-023

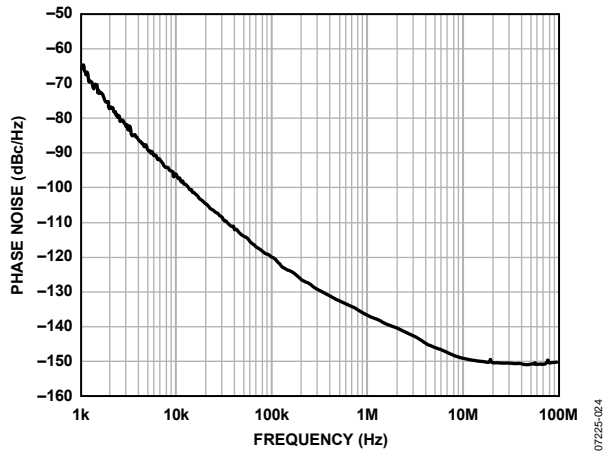

Figure 24. Internal VCO Phase Noise (Absolute), LVDS Output @ 533 MHz

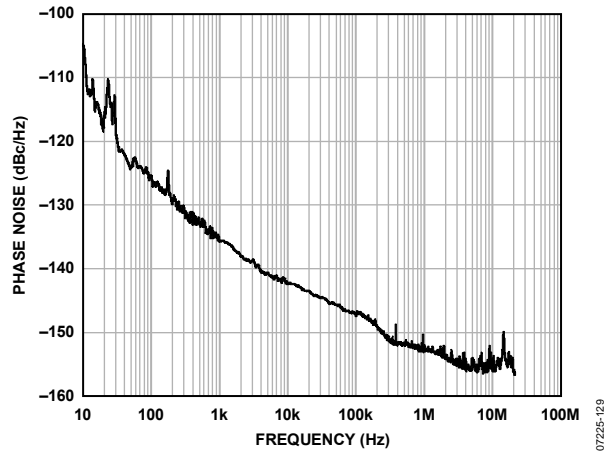

Figure 27. Additive (Residual) Phase Noise, CLK-to-LVDS @ 200 MHz, Divide-by-5

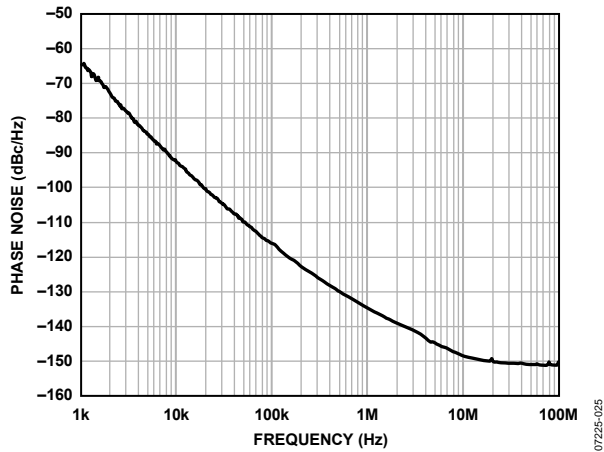

Figure 25. Internal VCO Phase Noise (Absolute), LVDS Output @ 600 MHz

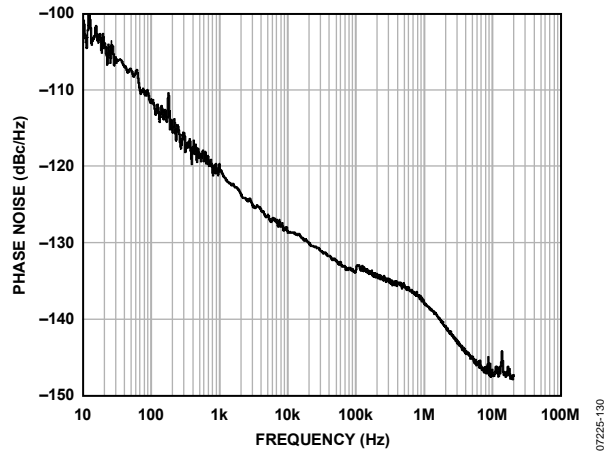

Figure 28. Additive (Residual) Phase Noise, CLK-to-LVDS @ 800 MHz, Divide-by-1

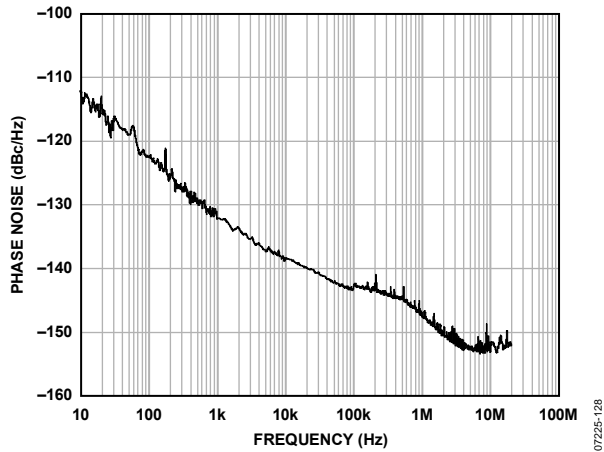

Figure 26. Additive (Residual) Phase Noise, CLK-to-LVDS @ 245.76 MHz, Divide-by-1

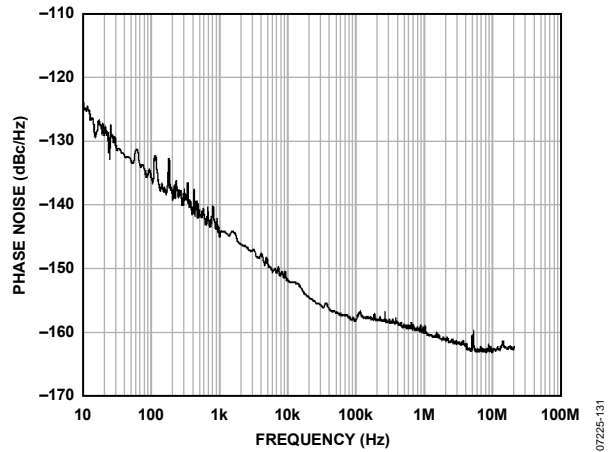

Figure 29. Additive (Residual) Phase Noise, CLK-to-CMOS @ 50 MHz, Divide-by-20

# AD9522-4

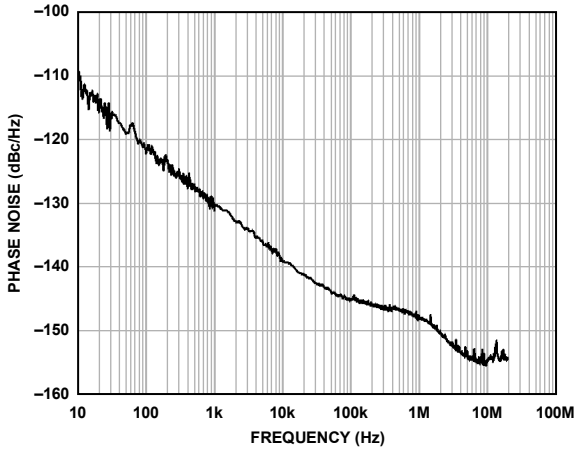

Figure 30. Additive (Residual) Phase Noise, CLK-to-CMOS @ 250 MHz, Divide-by-4

07225-132

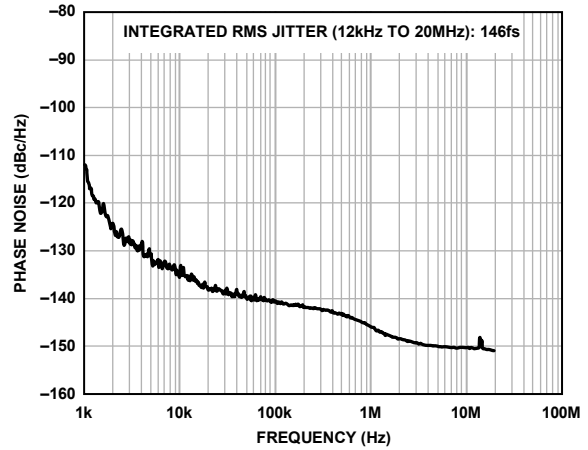

Figure 33. Phase Noise (Absolute), External VCXO (Toyocom TCO-2112) @ 245.76 MHz; PFD = 15.36 MHz; LBW = 250 Hz; LVDS Output = 245.76 MHz

07225-135

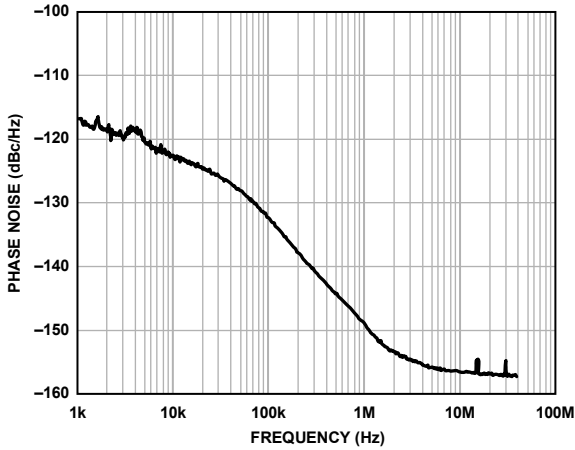

Figure 31. Phase Noise (Absolute) Clock Generation; Internal VCO @ 1475 MHz; PFD = 15.36 MHz; LBW = 40 kHz; LVDS Output = 122.88 MHz

07225-033

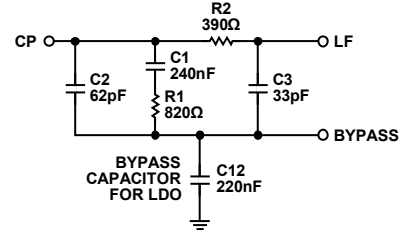

Figure 34. PLL Loop Filter Used for Clock Generation Plot (See Figure 31)

07225-234

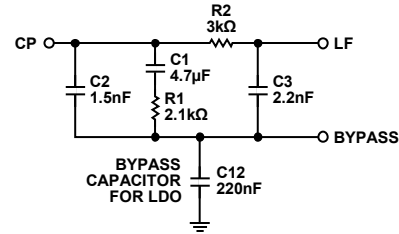

Figure 35. PLL Loop Filter Used for Clock Cleanup Plot (See Figure 32)

07225-235

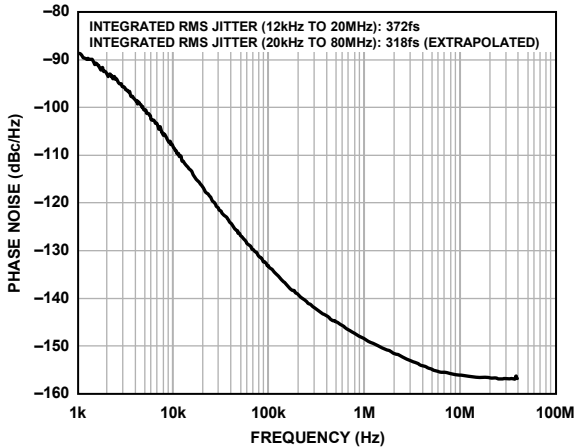

Figure 32. Phase Noise (Absolute) Clock Cleanup; Internal VCO @ 1400 MHz; PFD = 120 kHz; LBW = 1.84 kHz; LVDS Output = 155.52 MHz

07225-034



## TERMINOLOGY

### Phase Jitter and Phase Noise

An ideal sine wave can be thought of as having a continuous and even progression of phase with time from 0° to 360° for each cycle. Actual signals, however, display a certain amount of variation from ideal phase progression over time. This phenomenon is called phase jitter. Although many causes can contribute to phase jitter, one major cause is random noise, which is characterized statistically as Gaussian (normal) in distribution.

This phase jitter leads to a spreading out of the energy of the sine wave in the frequency domain, producing a continuous power spectrum. This power spectrum is usually reported as a series of values whose units are dBc/Hz at a given offset in frequency from the sine wave (carrier). The value is a ratio (expressed in decibels) of the power contained within a 1 Hz bandwidth with respect to the power at the carrier frequency. For each measurement, the offset from the carrier frequency is also given.

It is meaningful to integrate the total power contained within some interval of offset frequencies (for example, 10 kHz to 10 MHz). This is called the integrated phase noise over that frequency offset interval and can be readily related to the time jitter due to the phase noise within that offset frequency interval.

Phase noise has a detrimental effect on the performance of ADCs, DACs, and RF mixers. It lowers the achievable dynamic range of the converters and mixers, although they are affected in somewhat different ways.

### Time Jitter

Phase noise is a frequency domain phenomenon. In the time domain, the same effect is exhibited as time jitter. When observing a sine wave, the time of successive zero crossings varies. In a square wave, the time jitter is a displacement of the edges from their ideal (regular) times of occurrence. In both cases, the variations in timing from the ideal are the time jitter. Because these variations are random in nature, the time jitter is specified in seconds root mean square (rms) or 1 sigma of the Gaussian distribution.

Time jitter that occurs on a sampling clock for a DAC or an ADC decreases the signal-to-noise ratio (SNR) and dynamic range of the converter. A sampling clock with the lowest possible jitter provides the highest performance from a given converter.

### Additive Phase Noise

Additive phase noise is the amount of phase noise that is attributable to the device or subsystem being measured. The phase noise of any external oscillators or clock sources is subtracted. This makes it possible to predict the degree to which the device impacts the total system phase noise when used in conjunction with the various oscillators and clock sources, each of which contributes its own phase noise to the total. In many cases, the phase noise of one element dominates the system phase noise. When there are multiple contributors to phase noise, the total is the square root of the sum of squares of the individual contributors.

### Additive Time Jitter

Additive time jitter is the amount of time jitter that is attributable to the device or subsystem being measured. The time jitter of any external oscillators or clock sources is subtracted. This makes it possible to predict the degree to which the device impacts the total system time jitter when used in conjunction with the various oscillators and clock sources, each of which contributes its own time jitter to the total. In many cases, the time jitter of the external oscillators and clock sources dominates the system time jitter.

DETAILED BLOCK DIAGRAM

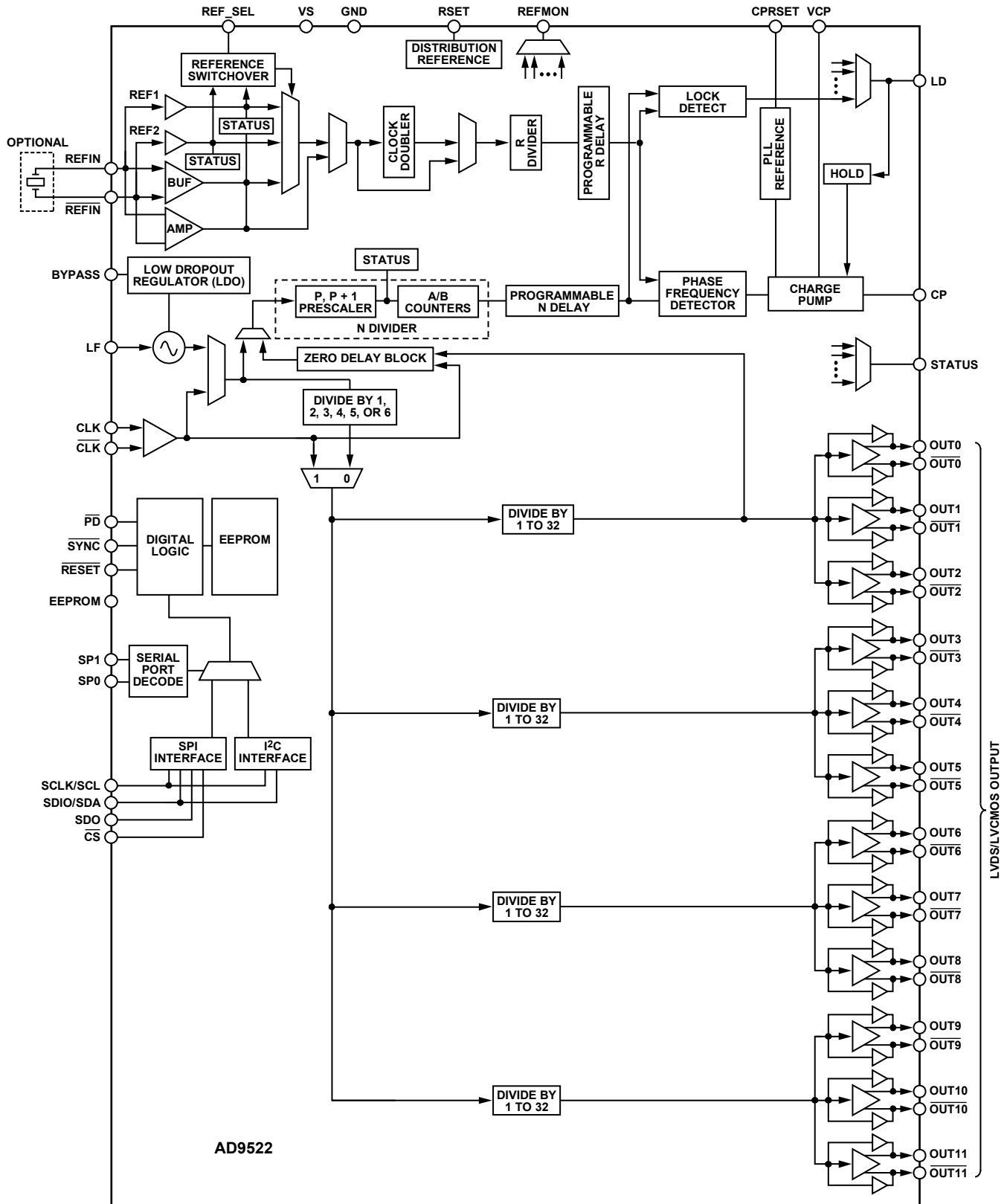

Figure 36.

07225-028

## THEORY OF OPERATION

### OPERATIONAL CONFIGURATIONS

The AD9522 can be configured in several ways. These configurations must be set up by loading the control registers (see Table 48 to Table 59). Each section or function must be individually programmed by setting the appropriate bits in the corresponding control register or registers. When the desired configuration is programmed, the user can store these values in the on-board EEPROM to allow the part to power up in the desired configuration without user intervention.

#### **Mode 0: Internal VCO and Clock Distribution**

When using the internal VCO and PLL, the VCO divider must be employed to ensure that the frequency presented to the channel dividers does not exceed its specified maximum frequency (see Table 3). The internal PLL uses an external loop filter to set the loop bandwidth. The external loop filter is also crucial to the loop stability.

When using the internal VCO, it is necessary to calibrate the VCO (0x018[0]) to ensure optimal performance.

For internal VCO and clock distribution applications, the register settings shown in Table 22 should be used.

**Table 22. Settings When Using Internal VCO**

Register	Description
0x010[1:0] = 00b	PLL normal operation (PLL on)
0x010 to 0x01E	PLL settings; select and enable a reference input; set R, N (P, A, B), PFD polarity, and $I_{CP}$ according to the intended loop configuration
0x1E1[1] = 1b	VCO selected as the source
0x01C[2:0]	Enable reference inputs
0x1E0[2:0]	Set VCO divider
0x1E1[0] = 0b	Use the VCO divider as the source for the distribution section
0x018[0] = 0b	Reset VCO calibration and issue IO_UPDATE (not necessary for the first time after power-up but must be done subsequently)
0x232[0] = 1b	
0x018[0] = 1b	Initiate VCO calibration, issue IO_UPDATE
0x232[0] = 1b	

# AD9522-4

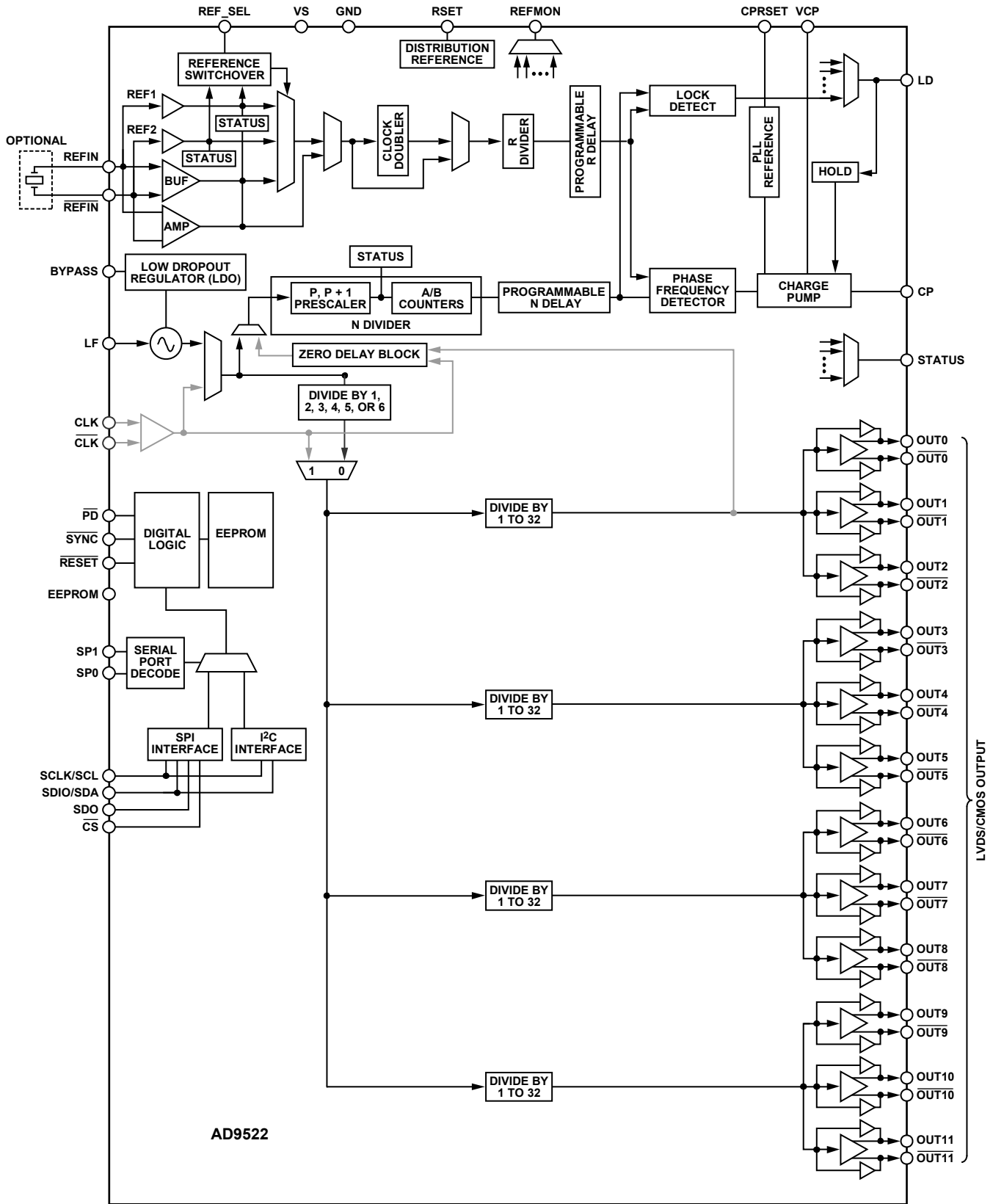

Figure 37. Internal VCO and Clock Distribution (Mode 0)

07225-030

**Mode 1: Clock Distribution or External VCO < 1600 MHz**

When the external clock source to be distributed or the external VCO/VCXO is <1600 MHz, a configuration that bypasses the VCO divider can be used. This is the only difference from Mode 2. Bypassing the VCO divider limits the frequency of the clock source to <1600 MHz (due to the maximum input frequency allowed at the channel dividers).

**Configuration and Register Settings**

For clock distribution applications where the external clock is <1600 MHz, the register settings shown in Table 23 should be used.

**Table 23. Settings for Clock Distribution < 1600 MHz**

Register	Description
0x010[1:0] = 01b	PLL asynchronous power-down (PLL off)
0x1E1[0] = 1b	Bypass the VCO divider as the source for the distribution section
0x1E1[1] = 0b	CLK selected as the source

When using the internal PLL with an external VCO < 1600 MHz, the PLL must be turned on.

**Table 24. Settings for Using Internal PLL with External VCO < 1600 MHz**

Register	Description
0x1E1[0] = 1b	Bypass the VCO divider as the source for the distribution section
0x010[1:0] = 00b	PLL normal operation (PLL on) along with other appropriate PLL settings in 0x010 to 0x01E

An external VCO/VCXO requires an external loop filter that must be connected between CP and the tuning pin of the VCO/VCXO. This loop filter determines the loop bandwidth and stability of the PLL. Make sure to select the proper PFD polarity for the VCO/VCXO being used.

**Table 25. Setting the PFD Polarity**

Register	Description
0x010[7] = 0b	PFD polarity positive (higher control voltage produces higher frequency)
0x010[7] = 1b	PFD polarity negative (higher control voltage produces lower frequency)

# AD9522-4



Figure 38. Clock Distribution or External VCO < 1600 MHz (Mode 1)

07225-031

### Mode 2: High Frequency Clock Distribution—CLK or External VCO > 1600 MHz

The AD9522 power-up default configuration has the PLL powered off and the routing of the input set so that the CLK/CLK input is connected to the distribution section through the VCO divider (divide-by-1/divide-by-2/divide-by-3/divide-by-4/divide-by-5/divide-by-6). This is a distribution-only mode that allows for an external input up to 2400 MHz (see Table 3). The maximum frequency that can be applied to the channel dividers is 1600 MHz; therefore, higher input frequencies must be divided down before reaching the channel dividers.

When the PLL is enabled, this routing also allows the use of the PLL with an external VCO or VCXO with a frequency <2400 MHz. In this configuration, the internal VCO is not used and is powered off. The external VCO/VCXO feeds directly into the prescaler.

The register settings shown in Table 26 are the default values of these registers at power-up or after a reset operation.

**Table 26. Default Register Settings for Clock Distribution Mode**

Register	Description
0x010[1:0] = 01b	PLL asynchronous power-down (PLL off)
0x1E0[2:0] = 000b	Set VCO divider = 2
0x1E1[0] = 0b	Use the VCO divider
0x1E1[1] = 0b	CLK selected as the source

When using the internal PLL with an external VCO, the PLL must be turned on.

**Table 27. Settings When Using an External VCO**

Register	Description
0x010[1:0] = 00b	PLL normal operation (PLL on)
0x010 to 0x01E	PLL settings; select and enable a reference input; set R, N (P, A, B), PFD polarity, and $I_{CP}$ according to the intended loop configuration
0x1E1[1] = 0b	CLK selected as the source

An external VCO requires an external loop filter that must be connected between CP and the tuning pin of the VCO. This loop filter determines the loop bandwidth and stability of the PLL. Make sure to select the proper PFD polarity for the VCO being used.

**Table 28. Setting the PFD Polarity**

Register	Description
0x010[7] = 0b	PFD polarity positive (higher control voltage produces higher frequency)
0x010[7] = 1b	PFD polarity negative (higher control voltage produces lower frequency)

# AD9522-4

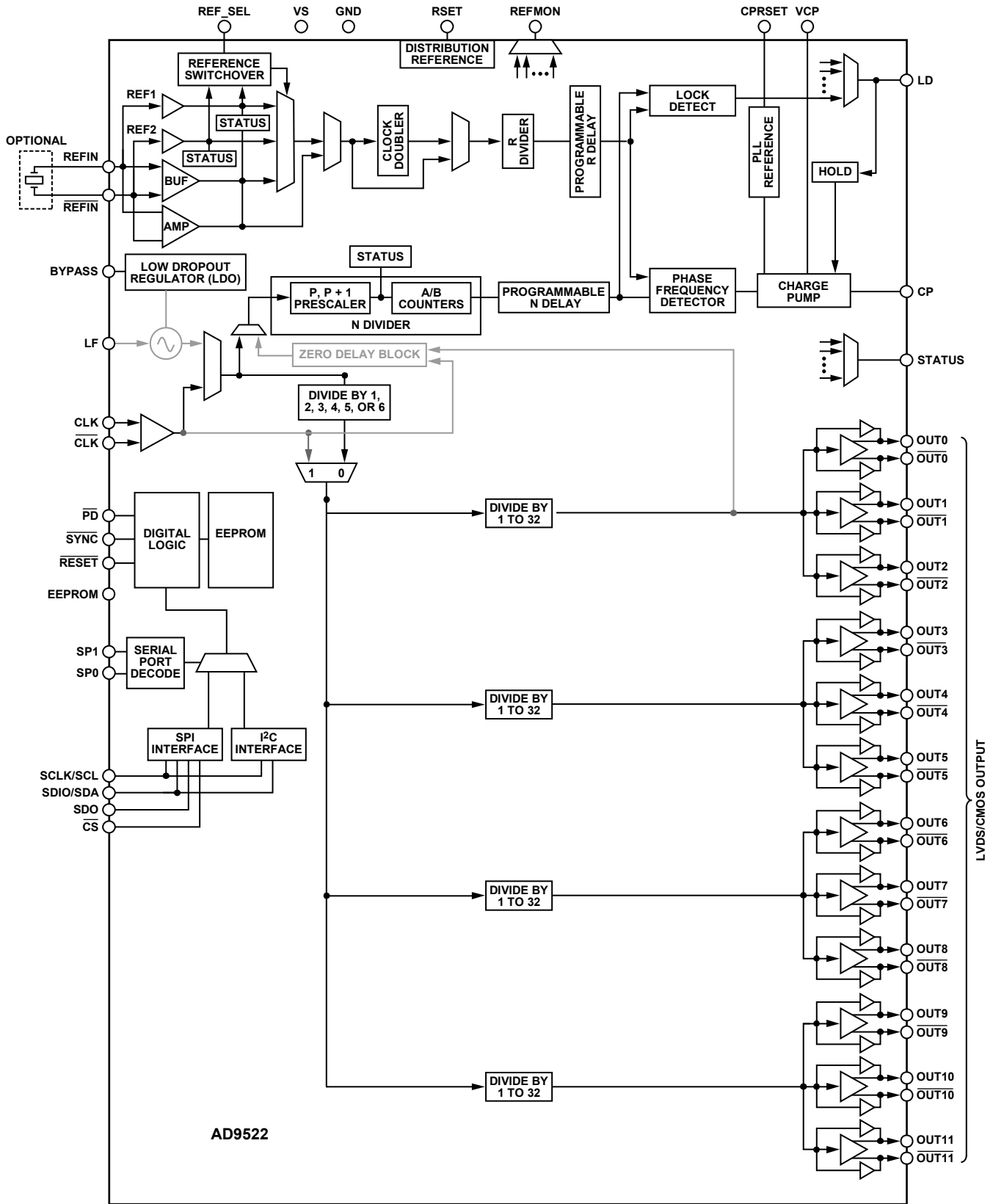

Figure 39. High Frequency Clock Distribution or External VCO > 1600 MHz (Mode 2)

07225-029



**Phase-Locked Loop (PLL)**

Figure 40. PLL Functional Block Diagram

The AD9522 includes an on-chip PLL with an on-chip VCO. The PLL blocks can be used either with the on-chip VCO to create a complete phase-locked loop or with an external VCO or VCXO. The PLL requires an external loop filter, which usually consists of a small number of capacitors and resistors. The configuration and components of the loop filter help to establish the loop bandwidth and stability of the operating PLL. The AD9522 PLL is useful for generating clock frequencies from a supplied reference frequency. This includes conversion of reference frequencies to much higher frequencies for subsequent division and distribution. In addition, the PLL can be used to clean up jitter and phase noise on a noisy reference. The exact choice of PLL parameters and loop dynamics is application specific. The flexibility and depth of the AD9522 PLL allow the part to be tailored to function in many different applications and signal environments.

**Configuration of the PLL**

The AD9522 allows flexible configuration of the PLL, accommodating various reference frequencies, PFD comparison frequencies, VCO frequencies, internal or external VCO/VCXO, and loop dynamics. This is accomplished by the various settings for the R divider, the N divider, the PFD polarity (only applicable to external VCO/VCXO), the antibacklash pulse width, the charge pump current, the selection of internal VCO or external VCO/VCXO, and the loop bandwidth. These are managed through programmable register settings (see Table 48 and Table 52) and by the design of the external loop filter.

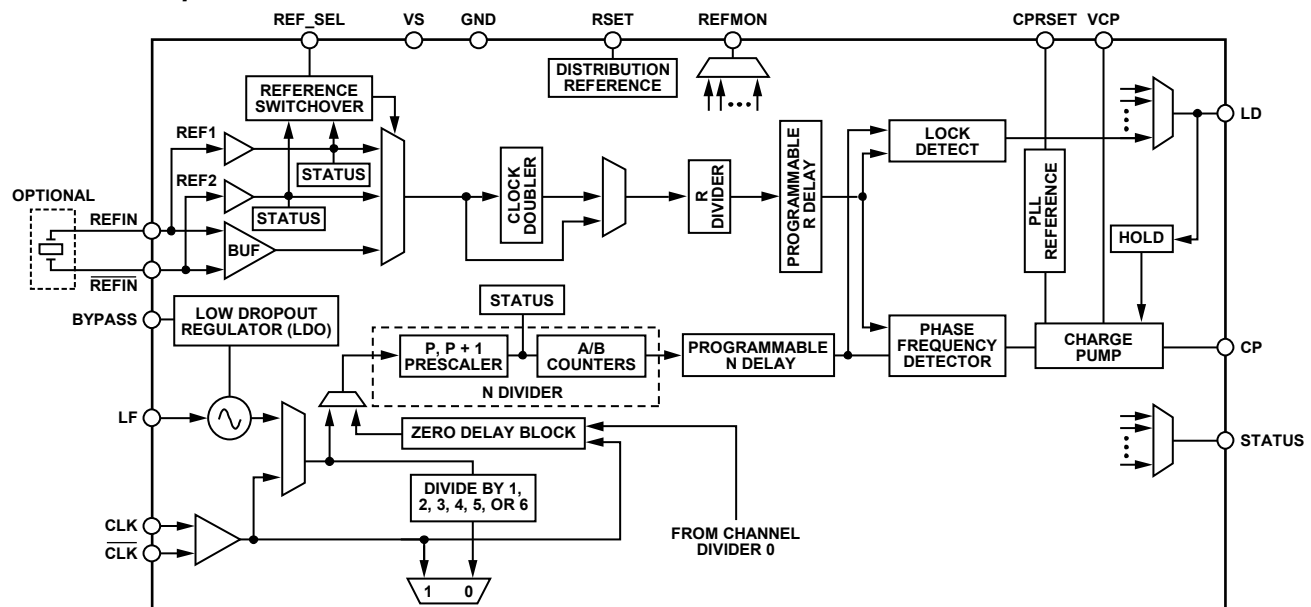
Successful PLL operation and satisfactory PLL loop performance are highly dependent upon proper configuration of the PLL settings, and the design of the external loop filter is crucial to the proper operation of the PLL.

ADIsimCLK™ is a free program that can help with the design and exploration of the capabilities and features of the AD9522, including the design of the PLL loop filter. The AD9516 model found in ADIsimCLK Version 1.2 can also be used for modeling the AD9522 loop filter. It is available at [www.analog.com/clocks](http://www.analog.com/clocks).

**Phase Frequency Detector (PFD)**

The PFD takes inputs from the R divider and the N divider and produces an output proportional to the phase and frequency difference between them. The PFD includes a programmable delay element that controls the width of the antibacklash pulse. This pulse ensures that there is no dead zone in the PFD transfer function and minimizes phase noise and reference spurs. The antibacklash pulse width is set by 0x017[1:0].

An important limit to keep in mind is the maximum frequency allowed into the PFD. The maximum input frequency into the PFD is a function of the antibacklash pulse setting, as specified in the phase/frequency detector (PFD) parameter in Table 2.

# AD9522-4

## Charge Pump (CP)

The charge pump is controlled by the PFD. The PFD monitors the phase and frequency relationship between its two inputs and tells the CP to pump up or pump down to charge or discharge the integrating node (part of the loop filter). The integrated and filtered CP current is transformed into a voltage that drives the tuning node of the internal VCO through the LF pin (or the tuning pin of an external VCO) to move the VCO frequency up or down. The CP can be set (0x010[3:2]) for high impedance (allows holdover operation), for normal operation (attempts to lock the PLL loop), for pump-up, or for pump-down (test modes). The CP current is programmable in eight steps from (nominally) 0.6 mA to 4.8 mA. The exact value of the CP current LSB is set by the CPRSET resistor, which is nominally 5.1 k $\Omega$ .

## On-Chip VCO

The AD9522 includes an on-chip VCO covering the frequency range shown in Table 2. Achieving low VCO phase noise was a priority in the design of the VCO.

To tune over the wide range of frequencies covered by this VCO, tuning ranges are used. The calibration procedure selects the correct range for the desired VCO frequency. See the VCO Calibration section for additional information.

The on-chip VCO is powered by an on-chip, low dropout (LDO), linear voltage regulator. The LDO provides some isolation of the VCO from variations in the power supply voltage level. The BYPASS pin should be connected to ground by a 220 nF capacitor to ensure stability. This LDO employs the same technology used in the anyCAP® line of regulators from Analog Devices, Inc., making it insensitive to the type of capacitor used. Driving an external load from the BYPASS pin is not supported.

When using an external VCO/VCXO, the BYPASS and LF pins should be left floating. This configuration is shown in Figure 42.

## PLL External Loop Filter

When using the internal VCO, the external loop filter should be referenced to the BYPASS pin for optimal noise and spurious performance. An example of an external loop filter for a PLL that uses the internal VCO is shown in Figure 41. A loop filter must be calculated for each desired PLL configuration. The values of the components depend upon the VCO frequency, the  $K_{VCO}$ , the PFD frequency, the CP current, the desired loop bandwidth, and the desired phase margin. The loop filter affects the phase noise, the loop settling time, and the loop stability. A basic knowledge of PLL theory is helpful for understanding loop filter design. ADIsimCLK can help with the calculation of a loop filter according to the application requirements.

When using an external VCO, the external loop filter should be referenced to ground. An example of an external loop filter for a PLL using an external VCO is shown in Figure 42.

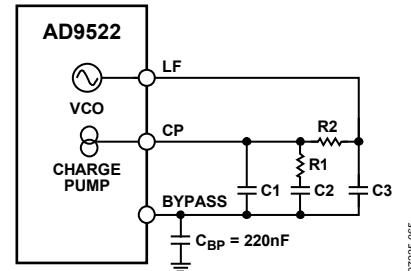

Figure 41. Example of External Loop Filter for a PLL Using the Internal VCO

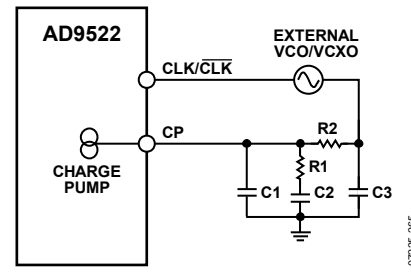

Figure 42. Example of External Loop Filter for a PLL Using an External VCO

## PLL Reference Inputs

The AD9522 features a flexible PLL reference input circuit that allows a fully differential input, two separate single-ended inputs, or a 16.67 MHz to 33.33 MHz crystal oscillator with an on-chip maintaining amplifier. An optional reference clock doubler can be used to double the PLL reference frequency. The input frequency range for the reference inputs is specified in Table 2. Both the differential and the single-ended inputs are self-biased, allowing for easy ac coupling of input signals.

Either a differential or a single-ended reference must be specifically enabled. All PLL reference inputs are off by default.

The differential input and the single-ended inputs share two pins, REFIN (REF1) and  $\overline{\text{REFIN}}$  (REF2). The desired reference input type is selected and controlled by 0x01C (see Table 48 and Table 52).

When the differential reference input is selected, the self-bias level of the two sides is offset slightly to prevent chattering of the input buffer when the reference is slow or missing. The specification for this voltage level can be found in Table 2. The input hysteresis increases the voltage swing required of the driver to overcome the offset.

The single-ended inputs can be driven by either a dc-coupled CMOS level signal or an ac-coupled sine wave or square wave. To avoid input buffer chatter when a single-ended, ac-coupled input signal stops toggling, the user can set 0x018[7] to 1b. This shifts the dc offset bias point down 140 mV. To increase isolation and reduce power, each single-ended input can be independently powered down.

The differential reference input receiver is powered down when it is not selected or when the PLL is powered down. The single-ended buffers power down when the PLL is powered down or when their respective individual power-down registers are set. When the differential mode is selected, the single-ended inputs are powered down.

In differential mode, the reference input pins are internally self-biased so that they can be ac-coupled via capacitors. It is possible to dc couple to these inputs. If the differential REFIN is driven by a single-ended signal, the unused side ( $\overline{\text{REFIN}}$ ) should be decoupled via a suitable capacitor to a quiet ground. Figure 43 shows the equivalent circuit of REFIN.

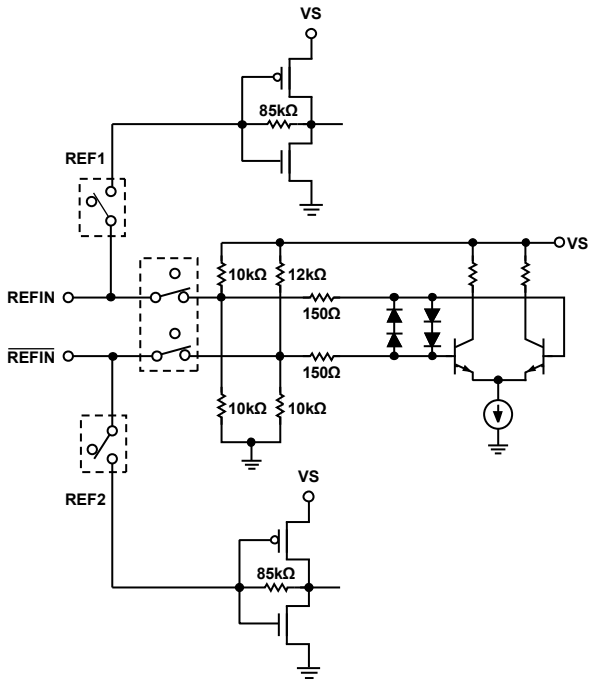

Figure 43. REFIN Equivalent Circuit for Non-XTAL Mode

Crystal mode is nearly identical to differential mode. The user enables a maintaining amplifier by setting the enable XTAL OSC bit, and putting a series resonant, AT fundamental cut crystal across the  $\overline{\text{REFIN}}$ /REFIN pins.

### Reference Switchover

The AD9522 supports dual single-ended CMOS inputs, as well as a single differential reference input. In the dual single-ended reference mode, the AD9522 supports automatic and manual PLL reference clock switching between REF1 (on Pin REFIN) and REF2 (on Pin  $\overline{\text{REFIN}}$ ). This feature supports networking and other applications that require redundant references.

The AD9522 features a dc offset option in single-ended mode. This option is designed to eliminate the risk of the reference inputs chattering when they are ac-coupled and the reference clock disappears. When using the reference switchover, the single-ended reference inputs should be dc-coupled CMOS levels (with the AD9522 dc offset feature disabled). Alternatively, the inputs can be ac-coupled and dc offset feature enabled. The user should keep in mind, however, that the minimum input amplitude for the reference inputs is greater when the dc offset is turned on.

There are several configurable modes of reference switchover. The switchover can be performed manually or automatically. Manual switchover is performed either through Register 0x01C or by using the REF\_SEL pin. The automatic switchover occurs when REF1 disappears. There is also a switchover deglitch feature that ensures that the PLL does not receive rising edges that are far out of alignment with the newly selected reference.

There are two automatic reference switchover modes (0x01C):

- Prefer REF1. Switch from REF1 to REF2 when REF1 disappears. Return to REF1 from REF2 when REF1 returns.
- Stay on REF2. Automatically switch to REF2 if REF1 disappears but do not switch back to REF1 if it reappears. The reference can be set back to REF1 manually at an appropriate time.

In automatic mode, REF1 is monitored by REF2. If REF1 disappears (two consecutive falling edges of REF2 without an edge transition on REF1), REF1 is considered missing. On the next subsequent rising edge of REF2, REF2 is used as the reference clock to the PLL. If 0x01C[3] = 0b (default), when REF1 returns (four rising edges of REF1 without two falling edges of REF2 between the REF1 edges), the PLL reference switches back to REF1. If 0x01C[3] = 1b, the user can control when to switch back to REF1. This is done by programming the part to manual reference select mode (0x01C[4] = 0b) and by ensuring that the registers and/or the REF\_SEL pin are set to select the desired reference. Automatic mode can be reenabled when REF1 is reselected.

Manual switchover requires the presence of a clock on the reference input being switched to or that the deglitching feature be disabled (0x01C[7]).

### Reference Divider R

The reference inputs are routed to the reference divider, R. R (a 14-bit counter) can be set to any value from 0 to 16,383 by writing to 0x011 and 0x012. (Both R = 0 and R = 1 give divide-by-1.) The output of the R divider goes to one of the PFD inputs to be compared with the VCO frequency divided by the N divider. The frequency applied to the PFD must not exceed the maximum allowable frequency, which depends on the antibacklash pulse setting (see Table 2).

The R divider has its own reset. The R divider can be reset using the shared reset bit of the R, A, and B counters. It can also be reset by a SYNC operation.

### VCO/VCXO Feedback Divider N: P, A, B, R

The N divider is a combination of a prescaler (P) and two counters, A and B. The total divider value is

$$N = (P \times B) + A$$

where P can be 2, 4, 8, 16, or 32.

## Prescaler

The prescaler of the AD9522 allows for two modes of operation: a fixed divide (FD) mode of 1, 2, or 3, and a dual modulus (DM) mode where the prescaler divides by P and (P + 1) {2 and 3, 4 and 5, 8 and 9, 16 and 17, or 32 and 33}. The prescaler modes of operation are given in Table 52, 0x016[2:0]. Not all modes are available at all frequencies (see Table 2).

When operating the AD9522 in dual modulus mode, P/(P + 1), the equation used to relate the input reference frequency to the VCO output frequency is

$$f_{VCO} = (f_{REF}/R) \times (P \times B + A) = f_{REF} \times N/R$$

However, when operating the prescaler in FD Mode 1, FD Mode 2, or FD Mode 3, the A counter is not used (A = 0) and the equation simplifies to

$$f_{VCO} = (f_{REF}/R) \times (P \times B) = f_{REF} \times N/R$$

When A = 0, the divide is a fixed divide of P = 2, 4, 8, 16, or 32.

By using combinations of DM and FD modes, the AD9522 can achieve values of N all the way down to N = 1. Table 29 shows how a 10 MHz reference input can be locked to any integer multiple of N.

Note that the same value of N can be derived in different ways, as illustrated by the case of N = 12. The user can choose a fixed divide mode P = 2 with B = 6, use the dual modulus mode 2/3 with A = 0, B = 6, or use the dual modulus mode 4/5 with A = 0, B = 3.

## A and B Counters

The B counter must be ≥3 or bypassed, and unlike the R counter, A = 0 is actually zero.

The maximum input frequency to the A/B counter is reflected in the maximum prescaler output frequency (~300 MHz) specified in Table 2. This is the prescaler input frequency (VCO or CLK) divided by P. For example, dual modulus P = 8/9 mode is not allowed if the VCO frequency is greater than 2400 MHz because the frequency going to the A/B counter is too high.

When the AD9522 B counter is bypassed (B = 1), the A counter should be set to zero, and the overall resulting divide is equal to the prescaler setting, P. The possible divide ratios in this mode are 1, 2, 3, 4, 8, 16, and 32. This mode is only useful when an external VCO/VCXO is used because the frequency range of the internal VCO requires an overall feedback divider greater than 32.

Although manual reset is not normally required, the A/B counters have their own reset bit. Alternatively, the A and B counters can be reset using the shared reset bit of the R, A, and B counters. Note that these reset bits are not self-clearing.

### R, A, and B Counters: SYNC Pin Reset

The R, A, and B counters can be reset simultaneously through the SYNC pin. This function is controlled by 0x019[7:6] (see Table 52). The SYNC pin reset is disabled by default.

### R and N Divider Delays

Both the R and N dividers feature a programmable delay cell. These delays can be enabled to allow adjustment of the phase relationship between the PLL reference clock and the VCO or CLK. Each delay is controlled by three bits. The total delay range is about 1 ns. See 0x019 in Table 2 and Table 52.

**Table 29. How a 10 MHz Reference Input Can Be Locked to Any Integer Multiple of N**

f <sub>REF</sub> (MHz)	R	P	A	B	N	f <sub>VCO</sub> (MHz)	Mode	Notes
10	1	1	X <sup>1</sup>	1	1	10	FD	P = 1, B = 1 (bypassed)
10	1	2	X <sup>1</sup>	1	2	20	FD	P = 2, B = 1 (bypassed)
10	1	1	X <sup>1</sup>	3	3	30	FD	P = 1, B = 3
10	1	1	X <sup>1</sup>	4	4	40	FD	P = 1, B = 4
10	1	1	X <sup>1</sup>	5	5	50	FD	P = 1, B = 5
10	1	2	X <sup>1</sup>	3	6	60	FD	P = 2, B = 3
10	1	2	0	3	6	60	DM	P and P + 1 = 2 and 3, A = 0, B = 3
10	1	2	1	3	7	70	DM	P and P + 1 = 2 and 3, A = 1, B = 3
10	1	2	2	3	8	80	DM	P and P + 1 = 2 and 3, A = 2, B = 3
10	1	2	1	4	9	90	DM	P and P + 1 = 2 and 3, A = 1, B = 4
10	1	2	X <sup>1</sup>	5	10	100	FD	P = 2, B = 5
10	1	2	0	5	10	100	DM	P and P + 1 = 2 and 3, A = 0, B = 5
10	1	2	1	5	11	110	DM	P and P + 1 = 2 and 3, A = 1, B = 5
10	1	2	X <sup>1</sup>	6	12	120	FD	P = 2, B = 6
10	1	2	0	6	12	120	DM	P and P + 1 = 2 and 3, A = 0, B = 6
10	1	4	0	3	12	120	DM	P and P + 1 = 4 and 5, A = 0, B = 3
10	1	4	1	3	13	130	DM	P and P + 1 = 4 and 5, A = 1, B = 3

<sup>1</sup> X = don't care.

### Digital Lock Detect (DLD)

By selecting the proper output through the mux on each pin, the DLD function is available at the LD, STATUS, and REFMON pins. The digital lock detect circuit indicates a lock when the time difference of the rising edges at the PFD inputs is less than a specified value (the lock threshold). The loss of a lock is indicated when the time difference exceeds a specified value (the unlock threshold). Note that the unlock threshold is wider than the lock threshold, which allows some phase error in excess of the lock window to occur without chattering on the lock indicator.

The lock detect window timing depends on the value of the CPRSET resistor, as well as three settings: the digital lock detect window bit (0x018[4]), the antibacklash pulse width bit (0x017[1:0], see Table 2), and the lock detect counter (0x018[6:5]). The lock and unlock detection values in Table 2 are for the nominal value of CPRSET = 5.11 kΩ. Doubling the CPRSET value to 10 kΩ doubles the values in Table 2.

A lock is not indicated until there is a programmable number of consecutive PFD cycles with a time difference less than the lock detect threshold. The lock detect circuit continues to indicate a lock until a time difference greater than the unlock threshold occurs on a single subsequent cycle. For the lock detect to work properly, the period of the PFD frequency must be greater than the unlock threshold. The number of consecutive PFD cycles required for lock is programmable (0x018[6:5]).

Note that it is possible in certain low (<500 Hz) loop bandwidth, high phase margin cases that the DLD can chatter during acquisition, which can cause the AD9522 to automatically enter and exit holdover. To avoid this problem, it is recommended that the user make provisions for a capacitor to ground on the LD pin so that current source digital lock detect (CSDL) mode can be used.

### Analog Lock Detect (ALD)

The AD9522 provides an ALD function that can be selected for use at the LD pin. There are two operating modes for ALD.

- N-channel open-drain lock detect. This signal requires a pull-up resistor to the positive supply, VS. The output is normally high with short, low going pulses. Lock is indicated by the minimum duty cycle of the low going pulses.
- P-channel open-drain lock detect. This signal requires a pull-down resistor to GND. The output is normally low with short, high going pulses. Lock is indicated by the minimum duty cycle of the high going pulses.

The analog lock detect function requires an RC filter to provide a logic level indicating lock/unlock. The ADIsimCLK tool can be used to help the user select the right passive component values for ALD to ensure its correct operation.

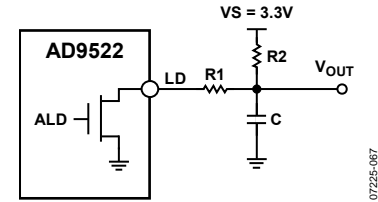

Figure 44. Example of Analog Lock Detect Filter Using N-Channel Open-Drain Driver

### Current Source Digital Lock Detect (CSDL)

During the PLL locking sequence, it is normal for the DLD signal to toggle a number of times before remaining steady when the PLL is completely locked and stable. There may be applications where it is desirable to have DLD asserted only after the PLL is solidly locked. This is possible by using the current source digital lock detect function.

The current source lock detect provides a current of 110 μA when DLD is true and shorts to ground when DLD is false. If a capacitor is connected to the LD pin, it charges at a rate determined by the current source during the DLD true time but is discharged nearly instantly when DLD is false. By monitoring the voltage at the LD pin (top of the capacitor), LD = high happens only after the DLD is true for a sufficiently long time. Any momentary DLD false resets the charging. By selecting a properly sized capacitor, it is possible to delay a lock detect indication until the PLL is stably locked and the lock detect does not chatter.

To use current source digital lock detect, do the following:

- Place a capacitor to ground on the LD pin
- Set 0x01A[5:0] = 0x04
- Enable the LD pin comparator (0x01D[3] = 1)

The LD pin comparator senses the voltage on the LD pin, and the comparator output can be made available at the REFMON pin control (0x01B[4:0]) or the STATUS pin control (0x017[7:2]). The internal LD pin comparator trip point and hysteresis are given in Table 17. The voltage on the capacitor can also be sensed by an external comparator connected to the LD pin. In this case, enabling the on-board LD pin comparator is not necessary.

The user can asynchronously enable individual clock outputs only when CSDL is high. To enable this feature, set the appropriate bits in the enable output on the CSDL registers (0x0FC and 0x0FD).



Figure 45. Current Source Digital Lock Detect

### External VCXO/VCO Clock Input ( $\overline{\text{CLK}}/\overline{\text{CLK}}$ )

This differential input is used to drive the AD9522 clock distribution section. This input can receive up to 2.4 GHz. The pins are internally self-biased, and the input signal should be ac-coupled via capacitors.

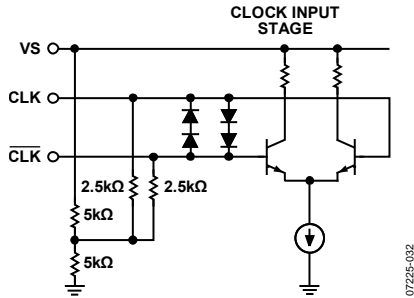

Figure 46. CLK Equivalent Input Circuit

The  $\overline{\text{CLK}}/\overline{\text{CLK}}$  input can be used either as a distribution only input (with the PLL off), or as a feedback input for an external VCO/VCXO using the internal PLL when the internal VCO is not used. These inputs are also used as a feedback path for the external zero delay mode.

### Holdover

The AD9522 PLL has a holdover function. Holdover is implemented by placing the charge pump in a high impedance state. This function is useful when the PLL reference clock is lost. Holdover mode allows the VCO to maintain a relatively constant frequency even though there is no reference clock. Without this function, the charge pump is placed into a constant pump-up or pump-down state, resulting in a massive VCO frequency shift. Because the charge pump is placed in a high impedance state, any leakage that occurs at the charge pump output or the VCO tuning node causes a drift of the VCO frequency. This can be mitigated by using a loop filter that contains a large capacitive component because this drift is limited by the current leakage induced slew rate ( $I_{\text{LEAK}}/C$ ) of the VCO control voltage.

Both a manual holdover mode, using the  $\overline{\text{SYNC}}$  pin, and an automatic holdover mode are provided. To use either function, the holdover function must be enabled (0x01D[0]).

### External/Manual Holdover Mode

A manual holdover mode can be enabled that allows the user to place the charge pump into a high impedance state when the  $\overline{\text{SYNC}}$  pin is asserted low. This operation is edge sensitive, not level sensitive. The charge pump enters a high impedance state immediately. To take the charge pump out of a high impedance state, take the  $\overline{\text{SYNC}}$  pin high. The charge pump then leaves the high impedance state synchronously with the next PFD rising edge from the reference clock. This prevents extraneous charge pump events from occurring during the time between  $\overline{\text{SYNC}}$  going high and the next PFD event. This also means that the charge pump stays in a high impedance state if there is no reference clock present.

The B counter (in the N divider) is reset synchronously with the charge pump leaving the high impedance state on the reference path PFD event. This helps align the edges out of the R and N dividers for faster settling of the PLL. Because the prescaler is not reset, this feature works best when the B and R numbers are close because this results in a smaller phase difference for the loop to settle out.

When using this mode, the channel dividers should be set to ignore the  $\overline{\text{SYNC}}$  pin (at least after an initial  $\overline{\text{SYNC}}$  event). If the dividers are not set to ignore the  $\overline{\text{SYNC}}$  pin, any time  $\overline{\text{SYNC}}$  is taken low to put the part into holdover, the distribution outputs turn off. The channel divider ignore  $\overline{\text{SYNC}}$  function is found in 0x191[6], 0x194[6], 0x197[6], and 0x19A[6] for Channel Divider 0, Channel Divider 1, Channel Divider 2, and Channel Divider 3, respectively.

### Automatic/Internal Holdover Mode

When enabled, this function automatically puts the charge pump into a high impedance state when the loop loses lock. The assumption is that the only reason the loop loses lock is due to the PLL losing the reference clock; therefore, the holdover function puts the charge pump into a high impedance state to maintain the VCO frequency as close as possible to the original frequency before the reference clock disappeared.

A flowchart of the automatic/internal holdover function operation is shown in Figure 47.

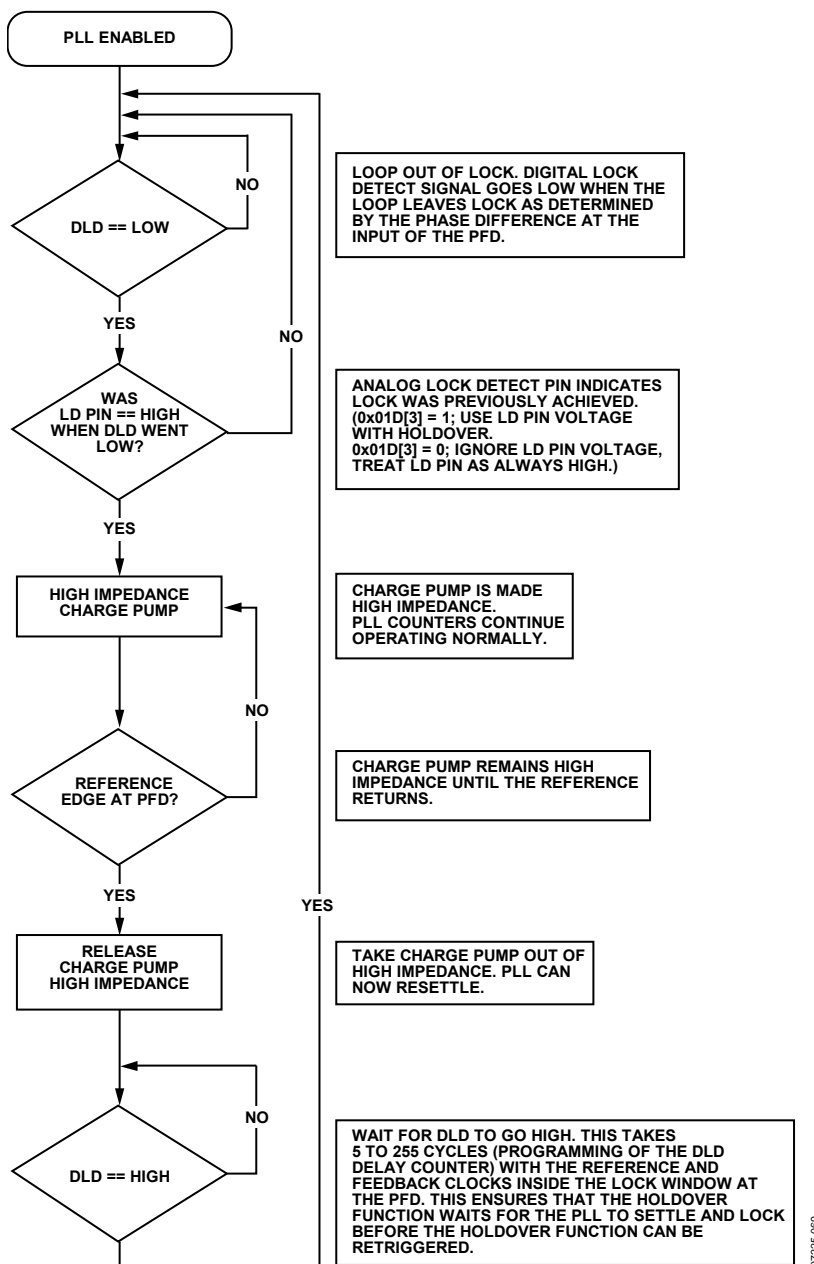

Figure 47. Flowchart of Automatic/Internal Holdover Mode

The holdover function senses the logic level of the LD pin as a condition to enter holdover. The signal at LD can be from the DLD, ALD, or current source LD (CSDL) mode. It is possible to disable the LD comparator (0x01D[3]), which causes the holdover function to always sense LD as high. If DLD is used, it is possible for the DLD signal to chatter while the PLL is reacquiring lock. The holdover function may retrigger, thereby preventing the holdover mode from terminating. Use of the current source lock detect mode is recommended to avoid this situation (see the Current Source Digital Lock Detect (CSDL) section).

When in holdover mode, the charge pump stays in a high impedance state as long as there is no reference clock present.

As in the external holdover mode, the B counter (in the N divider) is reset synchronously with the charge pump leaving the high impedance state on the reference path PFD event. This helps align the edges out of the R and N dividers for faster settling of the PLL and reduces frequency errors during settling. Because the prescaler is not reset, this feature works best when the B and R numbers are close because this results in a smaller phase difference for the loop to settle out.

After leaving holdover, the loop then reacquires lock and the LD pin must go high (if 0x01D[3] = 1) before it can reenter holdover.

The holdover function always responds to the state of the currently selected reference (0x01C). If the loop loses lock during a reference switchover (see the Reference Switchover section), holdover is triggered briefly until the next reference clock edge at the PFD.

The following registers affect the automatic/internal holdover function:

- 0x018[6:5]—lock detect counter. This changes how many consecutive PFD cycles with edges inside the lock detect window are required for the DLD indicator to indicate lock. This impacts the time required before the LD pin can begin to charge as well as the delay from the end of a holdover event until the holdover function can be reengaged.
- 0x018[3]—disable digital lock detect. This bit must be set to 0 to enable the DLD circuit. Internal/automatic holdover does not operate correctly without the DLD function enabled.
- 0x01A[5:0]—lock detect pin control. Set this to 000100b to put it in the current source lock detect mode if using the LD pin comparator. Load the LD pin with a capacitor of an appropriate value.
- 0x01D[3]—LD pin comparator enable. 1 = enable; 0 = disable. When disabled, the holdover function always senses the LD pin as high.
- 0x01D[1]—external holdover control.
- 0x01D[0]—holdover enable. If holdover is disabled, both external and automatic/internal holdover are disabled.

In the following example, automatic holdover is configured with

- Automatic reference switchover, prefer REF1.
- Digital lock detect: five PFD cycles, high range window.
- Automatic holdover using the LD pin comparator.

The following registers are set (in addition to the normal PLL registers):

- 0x018[6:5] = 00b; lock detect counter = five cycles.
- 0x018[4] = 0b; digital lock detect window = high range.
- 0x018[3] = 1b; disable DLD normal operation.
- 0x01A[5:0] = 000100b; program LD pin control to current source lock detect mode.
- 0x01C[4] = 1b; enable automatic switchover.
- 0x01C[3] = 0b; prefer REF1.
- 0x01C[2:1] = 11b; enable REF1 and REF2 input buffers.
- 0x01D[3] = 1b; enable LD pin comparator.
- 0x01D[1] = 0b; disable external holdover mode and use automatic/internal holdover mode.
- 0x01D[0] = 1b; enable holdover.

### Frequency Status Monitors

The AD9522 contains three frequency status monitors that are used to indicate if the PLL reference (or references in the case of single-ended mode) and the VCO have fallen below a threshold frequency. A diagram showing their location in the PLL is shown in Figure 48.

The PLL reference monitors have two threshold frequencies: normal and extended (see Table 17). The reference frequency monitor thresholds are selected in 0x01F.

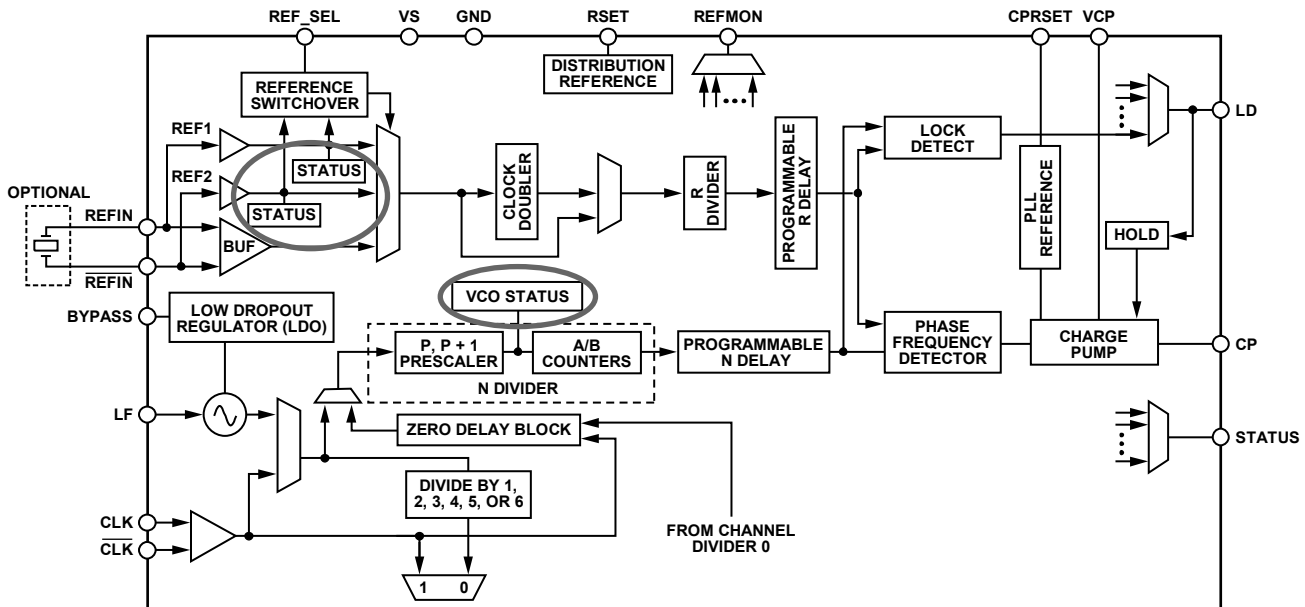

Figure 48. Reference and VCO Status Monitors

0725-070



### VCO Calibration

The AD9522 on-chip VCO must be calibrated to ensure proper operation over process and temperature. The VCO calibration is controlled by a calibration controller running off a divided REFIN clock. The calibration requires that the PLL be set up properly to lock the PLL loop and that the REFIN clock be present. The REFIN clock must come from a stable source external to the AD9522.

VCO calibration can be performed two ways: automatically at power-up and manually. Automatic VCO calibration occurs when the EEPROM is set to automatically load the preprogrammed values in the EEPROM and then automatically calibrate the VCO. A valid reference must be provided at power-up in order for the automatic calibration to complete. If this is not the case, the user must calibrate the VCO manually.

During the first initialization after a power-up or a reset of the AD9522, a manual VCO calibration sequence is initiated by setting 0x018[0] = 1b. This can be done as part of the initial setup before executing update registers (0x232[0] = 1b).

Subsequent to the initial setup, a VCO calibration sequence is initiated by resetting 0x018[0] = 0b, executing an update registers operation, setting 0x018[0] = 1b, and executing another update registers operation. A readback bit (0x01F[6]) indicates when a VCO calibration is finished by returning a logic true (that is, 1b).

The sequence of operations for the VCO calibration follows:

1. Program the PLL registers to the proper values for the PLL loop. Note that the VCO divider (0x1E0[2:0]) must not be set to static during VCO calibration.
2. For the initial setting of the registers after a power-up or reset, initiate a VCO calibration by setting 0x018[0] = 1b. Subsequently, whenever a calibration is desired, set 0x018[0] = 0b, update registers and set 0x018[0] = 1b, update registers.
3. A SYNC operation is initiated internally, causing the outputs to go to a static state determined by normal SYNC function operation.
4. VCO is calibrated to the desired setting for the requested VCO frequency.
5. Internally, the SYNC signal is released, allowing outputs to continue clocking.
6. The PLL loop is closed.
7. PLL locks.

A SYNC is executed during the VCO calibration; therefore, the outputs of the AD9522 are held static during the calibration, which prevents unwanted frequencies from being produced. However, at the end of a VCO calibration, the outputs may resume clocking before the PLL loop is completely settled.

The VCO calibration clock divider is set as shown in Table 52 (0x018[2:1]).

The calibration divider divides the PFD frequency (reference frequency divided by R) down to the calibration clock. The calibration occurs at the PFD frequency divided by the calibration divider setting. Lower VCO calibration clock frequencies result in longer times for a calibration to be completed.

The VCO calibration clock frequency is given by

$$f_{CAL\_CLOCK} = f_{REFIN} / (R \times cal\_div)$$

where:

$f_{REFIN}$  is the frequency of the REFIN signal.

R is the value of the R counter.

$cal\_div$  is the division set for the VCO calibration divider (0x018[2:1]).

The user should choose a calibration divider such that the calibration frequency is less than 6.25 MHz. Table 30 shows the appropriate value for the calibration divider.

**Table 30. VCO Calibration Divider Values for Different Phase Detector Frequencies**

PFD Rate (MHz)	Recommended VCO Calibration Divider
<12	Any
12 to 25	4, 8, 16
25 to 50	8, 16
50 to 100	16

The VCO calibration takes 4400 calibration clock cycles. Therefore, the VCO calibration time in PLL reference clock cycles is given by

$$Time\ to\ Calibrate\ VCO =$$

$$4400 \times R \times cal\_div\ PLL\ Reference\ Clock\ Cycles$$

The AD9522 does not automatically recalibrate its VCO when the PLL settings change. This allows for flexibility in deciding what order to program registers and when to initiate a calibration, instead of having it happen every time certain PLL registers have their values change. For example, this allows for the VCO frequency to be changed by small amounts without having an automatic calibration occur each time; this should be done with caution and only when the user knows the VCO control voltage will not exceed the nominal best performance limits. For example, a few 100 kHz steps are fine, but a few MHz may not be. Additionally, because the calibration procedure results in rapid changes in the VCO frequency, the distribution section is automatically placed in SYNC until the calibration is finished. Therefore, this temporary loss of outputs must be expected.

Initiate a VCO calibration under the following conditions:

- After changing any of the PLL R, P, B, and A divider settings or after a change in the PLL reference clock frequency. This, in effect, means any time a PLL register or reference clock is changed such that a different VCO frequency results.
- Whenever system calibration is desired. The VCO is designed to operate properly over extremes of temperature even when it is first calibrated at the opposite extreme. However, a VCO calibration can be initiated at any time, if desired.

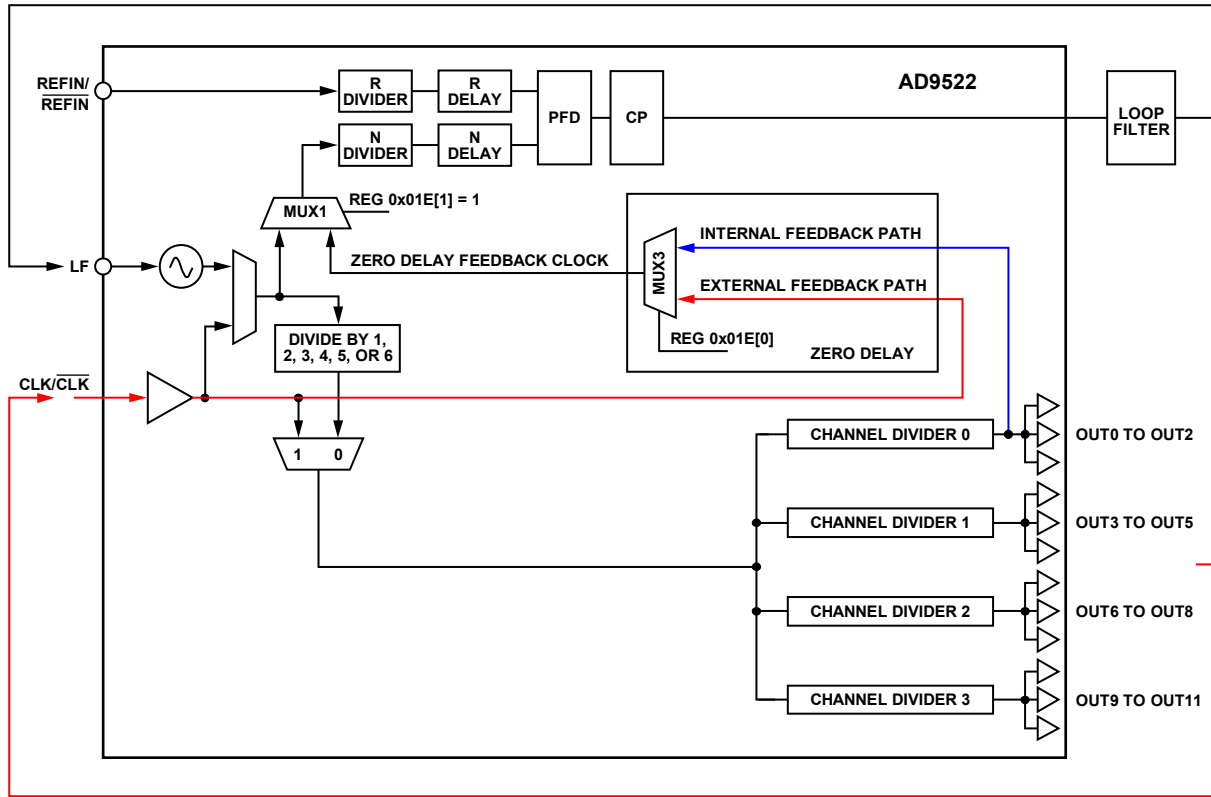

Figure 49. Zero Delay Function

## ZERO DELAY OPERATION

Zero delay operation aligns the phase of the output clocks with the phase of the external PLL reference input. There are two zero delay modes on the AD9522: internal and external.

### Internal Zero Delay Mode

The internal zero delay function of the AD9522 is achieved by feeding the output of Channel Divider 0 back to the PLL N divider. In Figure 49, the change in signal routing for internal zero delay mode is shown in blue.

Set Register 0x01E[2:1] = 01b to select internal zero delay mode. In the internal zero delay mode, the output of Channel Divider 0 is routed back to the PLL (N divider) through Mux3 and Mux1 (feedback path shown in blue in Figure 49). The PLL synchronizes the phase/edge of the output of Channel Divider 0 with the phase/edge of the reference input.

Because the channel dividers are synchronized to each other, the outputs of the channel divider are synchronous with the reference input. Both the R delay and the N delay inside the PLL can be programmed to compensate for the propagation delay from the output drivers and PLL components to minimize the phase offset between the clock output and the reference input to achieve zero delay.

### External Zero Delay Mode

The external zero delay function of the AD9522 is achieved by feeding one clock output back to the CLK input and ultimately back to the PLL N divider. In Figure 49, the change in signal routing for external zero delay mode is shown in red.

Setting 0x01E[2:1] = 11b to select the external zero delay mode. In external zero delay mode, one of the twelve output clocks (OUT0 to OUT11) can be routed back to the PLL (N divider) through the CLK/CLK pins and through Mux3 and Mux1. This feedback path is shown in red in Figure 49.

The user must specify which channel divider will be used for external zero delay mode in order for VCO calibration to work correctly. Channel Divider 0 is the default. Channel Divider 1, Channel Divider 2, or Channel Divider 3 can be selected for zero delay feedback by changing the value in Register 0x01E[4:3].

The PLL synchronizes the phase/edge of the feedback output clock with the phase/edge of the reference input. Because the channel dividers are synchronized to each other, the clock outputs are synchronous with the reference input. Both the R delay and the N delay inside the PLL can be programmed to compensate for the propagation delay from the PLL components to minimize the phase offset between the feedback clock and the reference input.

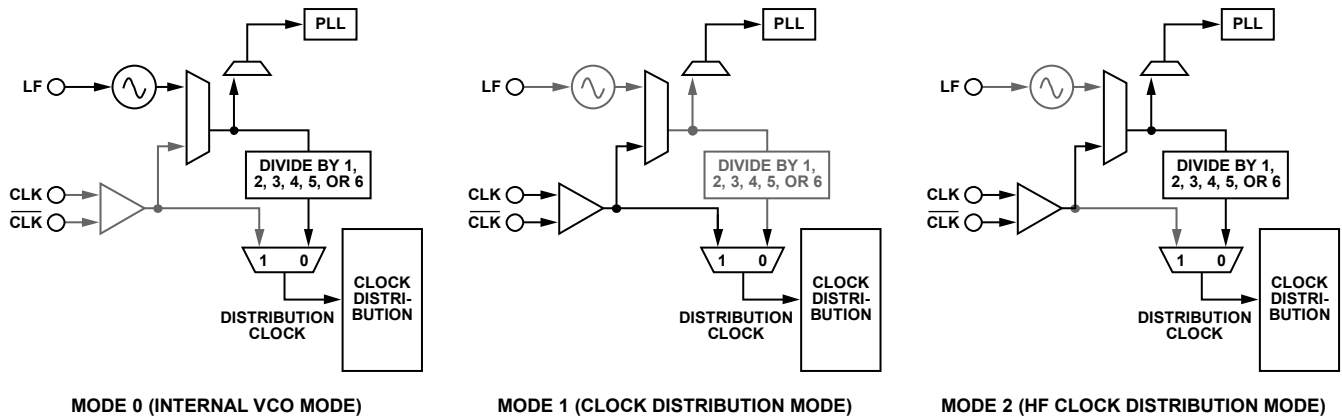

Figure 50. Simplified Diagram of the Three Clock Distribution Operation Modes

### CLOCK DISTRIBUTION

A clock channel consists of three LVDS clock outputs or six CMOS clock outputs that share a common divider. A clock output consists of the drivers that connect to the output pins. The clock outputs have either LVDS or CMOS at the pins.

The AD9522 has four clock channels. Each channel has its own programmable divider that divides the clock frequency applied to its input. The channel dividers can divide by any integer from 1 to 32.

The AD9522 features a VCO divider that divides the VCO output by 1, 2, 3, 4, 5, or 6 before going to the individual channel dividers. The VCO divider has two purposes. The first is to limit the maximum input frequency of the channel dividers to 1.6 GHz. The other is to allow the AD9522 to generate even lower frequencies than would be possible with only a simple post divider. External clock signals connected to the CLK input can also use the VCO divider.

The channel dividers allow for a selection of various duty cycles, depending on the currently set division. That is, for any specific division,  $D$ , the output of the divider can be set to high for  $N + 1$  input clock cycles and low for  $M + 1$  input clock cycles (where  $D = N + M + 2$ ). For example, a divide-by-5 can be high for one divider input cycle and low for four cycles, or a divide-by-5 can be high for three divider input cycles and low for two cycles. Other combinations are also possible.

The channel dividers include a duty-cycle correction function that can be disabled. In contrast to the selectable duty cycle just described, this function can correct a non-50% duty cycle caused by an odd division. However, this requires that the division be set by  $M = N + 1$ .

In addition, the channel dividers allow a coarse phase offset or delay to be set. Depending on the division selected, the output can be delayed by up to 15 input clock cycles. For example, if the frequency at the input of the channel divider is 1 GHz, the channel divider output can be delayed by up to 15 ns. The divider outputs can also be set to start high or to start low.

### Operation Modes

There are three clock distribution operating modes, and these are shown in Figure 50. One of these modes uses the internal VCO, whereas the other two modes bypass the internal VCO and use the signal provided on the CLK/CLK pins.

In Mode 0 (internal VCO mode), there are two signal paths available. In the first path, the VCO signal is sent to the VCO divider and then to the individual channel dividers. In the second path, the user bypasses the VCO and channel dividers and sends the VCO signal directly to the drivers.

When CLK is selected as the source, it is not necessary to use the VCO divider if the CLK frequency is less than the maximum channel divider input frequency (1600 MHz); otherwise, the VCO divider must be used to reduce the frequency going to the channel dividers.

Table 31 shows how the VCO, CLK, and VCO divider are selected. 0x1E1[1:0] selects the channel divider source and determines whether the VCO divider is used. It is not possible to select the VCO without using the VCO divider.

Table 31. Operation Modes

Mode	0x1E1		Channel Divider Source	VCO Divider
	[1]	[0]		
2	0	0	CLK	Used
1	0	1	CLK	Not used
0	1	0	VCO	Used
	1	1	Not allowed	Not allowed

## Clock Frequency Division

The total frequency division is a combination of the VCO divider (when used) and the channel divider. When the VCO divider is used, the total division from the VCO or CLK to the output is the product of the VCO divider (1, 2, 3, 4, 5, and 6) and the division of the channel divider. Table 32 indicates how the frequency division for a channel is set.

**Table 32. Frequency Division**

CLK or VCO Selected	VCO Divider Setting <sup>1</sup>	Channel Divider Setting	Resulting Frequency Division
CLK or VCO input	1 to 6	2 to 32	(1 to 6) × (2 to 32)
CLK or VCO input	2 to 6	Bypass	(2 to 6) × (1)
CLK or VCO input	1	Bypass	Output static (illegal state)
CLK(internal VCO off)	VCO divider bypassed	Bypass	1
CLK (internal VCO off)	VCO divider bypassed	2 to 32	2 to 32

<sup>1</sup> The bypass VCO divider (0x1E1[0] = 1) is not the same as VCO divider = 1.

The channel dividers feeding the output drivers contain one 2-to-32 frequency divider. This divider provides for division-by-1 to division-by-32. Division-by-1 is accomplished by bypassing the divider. The dividers also provide for a programmable duty cycle, with optional duty-cycle correction when the divide ratio is odd. A phase offset or delay in increments of the input clock cycle is selectable. The channel dividers operate with a signal at their inputs up to 1600 MHz. The features and settings of the dividers are selected by programming the appropriate setup and control registers (see Table 48 through Table 59).

### VCO Divider

The VCO divider provides frequency division between the internal VCO or the external CLK input and the clock distribution channel dividers. The VCO divider can be set to divide by 1, 2, 3, 4, 5, or 6 (see Table 55, 0x1E0[2:0]). However, when the VCO divider is set to 1, none of the channel output dividers can be bypassed.

The VCO divider can also be set to static, which is useful for applications where the only desired output frequency is the VCO frequency. Making the VCO divider static increases the wide band spurious-free dynamic range (SFDR). If the VCO divider is static during VCO calibration, there is no output signal. Therefore, it is recommended that the user calibrate the VCO with the VCO divider set to a nonstatic value during VCO calibration, and then set the VCO divider to static after VCO calibration is complete.

The recommended alternative to achieving the same SFDR performance is to set the VCO divider to 1. This allows the user to program the EEPROM with the desired values and does not require further action after the VCO calibration is complete.

## Channel Dividers

A channel divider drives each group of three LVDS outputs. There are four channel dividers (0, 1, 2, and 3) driving 12 LVDS outputs (OUT0 to OUT11). Table 33 gives the register locations used for setting the division and other functions of these dividers. The division is set by the values of M and N. The divider can be bypassed (equivalent to divide-by-1, divider circuit is powered down) by setting the bypass bit. The duty-cycle correction can be enabled or disabled according to the setting of the disable divider DCC bits.

**Table 33. Setting D<sub>x</sub> for the Output Dividers**

Divider	Low Cycles M	High Cycles N	Bypass	Disable Div DCC
0	0x190[7:4]	0x190[3:0]	0x191[7]	0x192[0]
1	0x193[7:4]	0x193[3:0]	0x194[7]	0x195[0]
2	0x196[7:4]	0x196[3:0]	0x197[7]	0x198[0]
3	0x199[7:4]	0x199[3:0]	0x19A[7]	0x19B[0]

### Channel Frequency Division (0, 1, 2, and 3)

For each channel (where the channel number x is 0, 1, 2, or 3), the frequency division, D<sub>x</sub>, is set by the values of M and N (four bits each, representing Decimal 0 to Decimal 15), where

$$\text{Number of Low Cycles} = M + 1$$

$$\text{Number of High Cycles} = N + 1$$

The high and low cycles are cycles of the clock signal currently routed to the input of the channel dividers (VCO divider out or CLK).

When a divider is bypassed, D<sub>x</sub> = 1.

Otherwise, D<sub>x</sub> = (N + 1) + (M + 1) = N + M + 2. This allows each channel divider to divide by any integer from 1 to 32.

### Duty Cycle and Duty-Cycle Correction

The duty cycle of the clock signal at the output of a channel is a result of some or all of the following conditions:

- The M and N values for the channel
- DCC enabled/disabled
- VCO divider enabled/bypassed
- The CLK input duty cycle (note that the internal VCO has a 50% duty cycle)

The DCC function is enabled by default for each channel divider. However, the DCC function can be disabled individually for each channel divider by setting the disable divider DCC bit for that channel.

Certain M and N values for a channel divider result in a non-50% duty cycle. A non-50% duty cycle can also result with an even division, if M ≠ N. The duty-cycle correction function automatically corrects non-50% duty cycles at the channel divider output to 50% duty cycle.

Duty-cycle correction requires the following channel divider conditions:

- An even division must be set as  $M = N$ .
- An odd division must be set as  $M = N + 1$ .

When not bypassed or corrected by the DCC function, the duty cycle of each channel divider output is the numerical value of  $(N + 1)/(N + M + 2)$  expressed as a percent.

The duty cycle at the output of the channel divider for various configurations is shown in Table 34 to Table 37.

**Table 34. Channel Divider Output Duty Cycle with VCO Divider  $\neq 1$ , Input Duty Cycle Is 50%**

VCO Divider	D <sub>x</sub>	Output Duty Cycle	
	N + M + 2	Disable Div DCC = 1	Disable Div DCC = 0
Even	Channel divider bypassed	50%	50%
Odd = 3	Channel divider bypassed	33.3%	50%
Odd = 5	Channel divider bypassed	40%	50%
Even, odd	Even	$(N + 1)/(N + M + 2)$	50%, requires $M = N$
Even, odd	Odd	$(N + 1)/(N + M + 2)$	50%, requires $M = N + 1$

**Table 35. Channel Divider Output Duty Cycle with VCO Divider  $\neq 1$ , Input Duty Cycle Is X%**

VCO Divider	D <sub>x</sub>	Output Duty Cycle	
	N + M + 2	Disable Div DCC = 1	Disable Div DCC = 0
Even	Channel divider bypassed	50%	50%
Odd = 3	Channel divider bypassed	33.3%	$(1 + X\%)/3$
Odd = 5	Channel divider bypassed	40%	$(2 + X\%)/5$
Even	Even	$(N + 1)/(N + M + 2)$	50%, requires $M = N$
Even	Odd	$(N + 1)/(N + M + 2)$	50%, requires $M = N + 1$
Odd = 3	Even	$(N + 1)/(N + M + 2)$	50%, requires $M = N$
Odd = 3	Odd	$(N + 1)/(N + M + 2)$	$(3N + 4 + X\%)/(6N + 9)$ , requires $M = N + 1$
Odd = 5	Even	$(N + 1)/(N + M + 2)$	50%, requires $M = N$
Odd = 5	Odd	$(N + 1)/(N + M + 2)$	$(5N + 7 + X\%)/(10N + 15)$ , requires $M = N + 1$

**Table 36. Channel Divider Output Duty Cycle When the VCO Divider Is Enabled and Set to 1**

Input Clock Duty Cycle	D <sub>x</sub>	Output Duty Cycle	
	N + M + 2	Disable Div DCC = 1	Disable Div DCC = 0
Any	Even	$(N + 1)/(M + N + 2)$	50%, requires $M = N$
50%	Odd	$(N + 1)/(M + N + 2)$	50%, requires $M = N + 1$
X%	Odd	$(N + 1)/(M + N + 2)$	$(N + 1 + X\%)/(2 \times N + 3)$ , requires $M = N + 1$

Note that the channel divider must be enabled when the VCO divider = 1.

**Table 37. Channel Divider Output Duty Cycle When the VCO Divider Is Bypassed**

Input Clock Duty Cycle	D <sub>x</sub>	Output Duty Cycle	
	N + M + 2	Disable Div DCC = 1	Disable Div DCC = 0
Any	Channel divider bypassed	Same as input duty cycle	Same as input duty cycle
Any	Even	$(N + 1)/(M + N + 2)$	50%, requires $M = N$
50%	Odd	$(N + 1)/(M + N + 2)$	50%, requires $M = N + 1$
X%	Odd	$(N + 1)/(M + N + 2)$	$(N + 1 + X\%)/(2 \times N + 3)$ , requires $M = N + 1$

The internal VCO has a duty cycle of 50%. Therefore, when the VCO divider equals 1, the duty cycle is 50%. If the CLK input is routed directly to the output, the duty cycle of the output is the same as the CLK input.

**Phase Offset or Coarse Time Delay**

Each channel divider allows for a phase offset, or a coarse time delay, to be programmed by setting register bits (see Table 38). These settings determine the number of cycles (successive rising edges) of the channel divider input frequency by which to offset, or delay, the rising edge of the output of the divider. This delay is with respect to a nondelayed output (that is, with a phase offset of zero). The amount of the delay is set by five bits loaded into the phase offset (PO) register plus the start high (SH) bit for each channel divider. When the start high bit is set, the delay is also affected by the number of low cycles (M) programmed for the divider.

It is necessary to use the SYNC function to make phase offsets effective (see the Synchronizing the Outputs— Function section).

**Table 38. Setting Phase Offset and Division**

Divider	Start High (SH)	Phase Offset (PO)	Low Cycles M	High Cycles N
0	0x191[4]	0x191[3:0]	0x190[7:4]	0x190[3:0]
1	0x194[4]	0x194[3:0]	0x193[7:4]	0x193[3:0]
2	0x197[4]	0x197[3:0]	0x196[7:4]	0x196[3:0]
3	0x19A[4]	0x19A[3:0]	0x199[7:4]	0x199[3:0]

Let

$\Delta_t$  = delay (in seconds).

$\Delta_c$  = delay (in cycles of clock signal at input to  $D_X$ ).

$T_X$  = period of the clock signal at the input of the divider,  $D_X$  (in seconds).

$\Phi$  =

$$16 \times SH[4] + 8 \times PO[3] + 4 \times PO[2] + 2 \times PO[1] + 1 \times PO[0]$$

The channel divide by is set as  $N$  = high cycles and  $M$  = low cycles.

### Case 1

For  $\Phi \leq 15$ ,

$$\Delta_t = \Phi \times T_X$$

$$\Delta_c = \Delta_t / T_X = \Phi$$

### Case 2

For  $\Phi \geq 16$ ,

$$\Delta_t = (\Phi - 16 + M + 1) \times T_X$$

$$\Delta_c = \Delta_t / T_X$$

By giving each divider a different phase offset, output-to-output delays can be set in increments of the channel divider input clock cycle. Figure 51 shows the results of setting such a coarse offset between outputs.

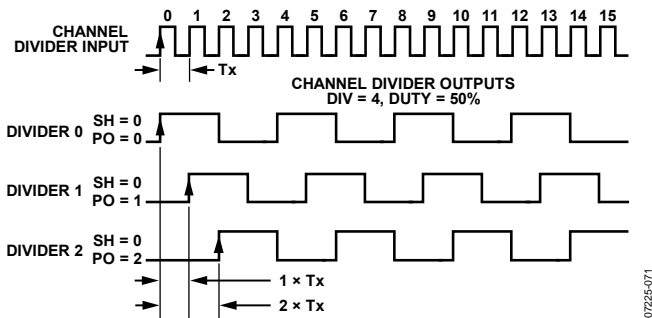

Figure 51. Effect of Coarse Phase Offset (or Delay)

## Synchronizing the Outputs—SYNC Function

The AD9522 clock outputs can be synchronized to each other. Outputs can be individually excluded from synchronization. Synchronization consists of setting the nonexcluded outputs to a preset set of static conditions. These conditions include the divider ratio and phase offsets for a given channel divider. This allows the user to specify different divide ratios and phase offsets for each of the four channel dividers. Releasing the SYNC pin allows the outputs to continue clocking with the preset conditions applied.

Synchronization of the outputs is executed in the following ways:

- The SYNC pin is forced low and then released (manual sync).
- By setting and then resetting any one of the following three bits: the soft SYNC bit (0x230[0]), the soft reset bit (0x000[5] [mirrored]), and the power-down distribution reference bit (0x230[1]).
- Synchronization of the outputs can be executed as part of the chip power-up sequence.
- The RESET pin is forced low and then released (chip reset).

- The PD pin is forced low and then released (chip power-down).
- Whenever a VCO calibration is completed, an internal SYNC signal is automatically asserted at the beginning and released upon the completion of a VCO calibration.

The most common way to execute the SYNC function is to use the SYNC pin to perform a manual synchronization of the outputs. This requires a low going signal on the SYNC pin, which is held low and then released when synchronization is desired. The timing of the SYNC operation is shown in Figure 52 (using the VCO divider) and in Figure 53 (the VCO divider is not used). There is an uncertainty of up to one cycle of the clock at the input to the channel divider due to the asynchronous nature of the SYNC signal with respect to the clock edges inside the AD9522.

The pipeline delay from the SYNC rising edge to the beginning of the synchronized output clocking is between 14 cycles and 15 cycles of clock at the channel divider input, plus one cycle of the VCO divider input (see Figure 52) or one cycle of the channel divider input (see Figure 53), depending on whether the VCO divider is used. Cycles are counted from the rising edge of the signal. In addition, there is an additional 1.2 ns (typical) delay from the SYNC signal to the internal synchronization logic, as well as the propagation delay of the output driver. The driver propagation delay is approximately 100 ps for the LVDS driver and approximately 1.5 ns for the CMOS driver.

Another common way to execute the SYNC function is by setting and resetting the soft SYNC bit at 0x230[0]. Both setting and resetting of the soft SYNC bit require an update all registers (0x232[0] = 1b) operation to take effect.

A SYNC operation brings all outputs that have not been excluded (by the ignore SYNC bit) to a preset condition before allowing the outputs to begin clocking in synchronicity. The preset condition takes into account the settings in each of the channel's start high bit and its phase offset. These settings govern both the static state of each output when the SYNC operation is happening and the state and relative phase of the outputs when they begin clocking again upon completion of the SYNC operation. Between outputs and after synchronization, this allows for the setting of phase offsets.

The AD9522 differential LVDS outputs are four groups of three, sharing a channel divider per triplet. In the case of CMOS, each LVDS differential pair can be configured as two single-ended CMOS outputs. The synchronization conditions apply to all of the drivers that belong to that channel divider.

Each channel (a divider and its outputs) can be excluded from any SYNC operation by setting the ignore SYNC bit of the channel. Channels that are set to ignore SYNC (excluded channels) do not set their outputs static during a SYNC operation, and their outputs are not synchronized with those of the included channels.

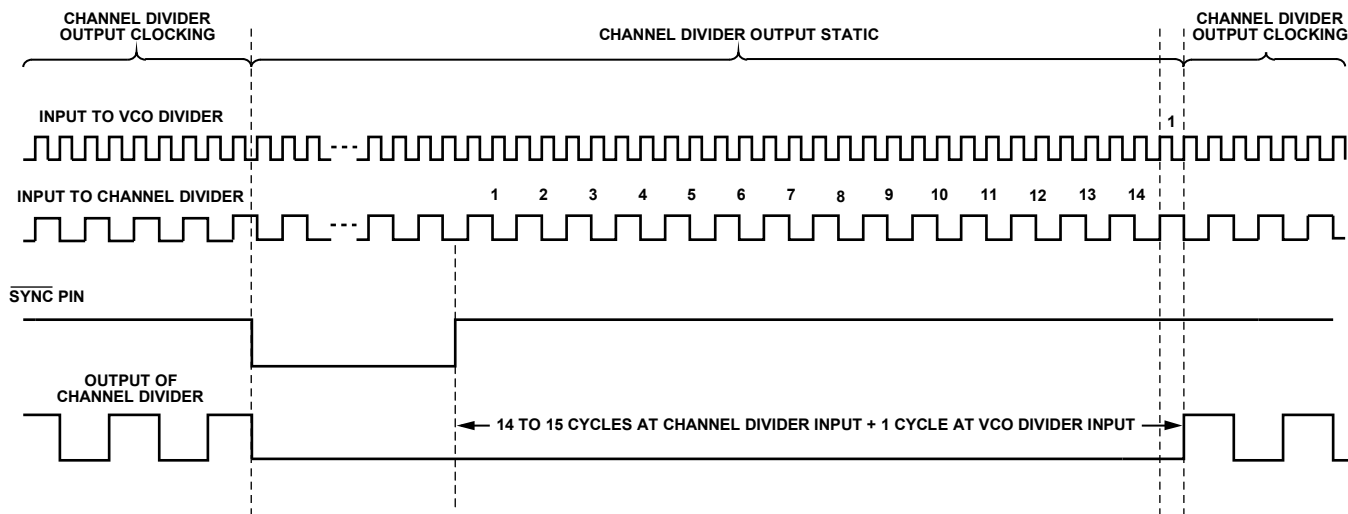

Figure 52. SYNC Timing Pipeline Delay When the VCO Divider Is Used—CLK or VCO Is Input



Figure 53. SYNC Timing Pipeline Delay When the VCO Divider Is Not Used—CLK Input Only

**LVDS Output Drivers**

The AD9522 output drivers can be configured as either an LVDS differential output or as a pair of CMOS single-ended outputs. The LVDS outputs allow for selectable output current from ~1.75 mA to ~7 mA.

The LVDS output polarity can be set as noninverting or inverting, which allows for the adjustment of the relative polarity of outputs within an application without requiring a board layout change. Each LVDS output can be individually powered down to save power.

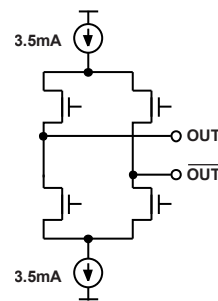

Figure 54. LVDS Output Simplified Equivalent Circuit with 3.5 mA Typical Current Source

# AD9522-4

## CMOS Output Drivers

The user can also individually configure each LVDS output as a pair of CMOS outputs, which provides up to 24 CMOS outputs. When an output is configured as CMOS, CMOS Output A and CMOS Output B are automatically turned on. For a given differential pair, either CMOS Output A or Output B can be turned on or off independently. The user can also select the relative polarity of the CMOS outputs for any combination of inverting and noninverting (see Register 0x0F0 to Register 0x0FB).

The user can power down each CMOS output as needed to save power. The CMOS output power-down is individually controlled by the enable CMOS output register (0x0F0[6:5] to 0x0FB[6:5]). The CMOS driver is in tristate when it is powered down.

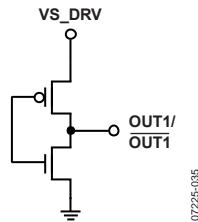

Figure 55. CMOS Equivalent Output Circuit

## RESET MODES

The AD9522 has a power-on reset (POR) and several other ways to apply a reset condition to the chip.

### Power-On Reset

During chip power-up, a power-on reset pulse is issued when VS reaches ~2.6 V (<2.8 V) and restores the chip either to the setting stored in EEPROM (with the EEPROM pin = 1) or to the on-chip setting (with the EEPROM pin = 0). At power-on, the AD9522 also executes a SYNC operation, which brings the outputs into phase alignment according to the default settings. The output drivers are held in sync for the duration of the internally generated power-up sync timer (~70 ms). The outputs begin to toggle after this period.

### Hardware Reset via the $\overline{\text{RESET}}$ Pin

$\overline{\text{RESET}}$ , a hard reset (an asynchronous hard reset is executed by briefly pulling  $\overline{\text{RESET}}$  low), restores the chip either to the setting stored in EEPROM (the EEPROM pin = 1) or to the on-chip setting (the EEPROM pin = 0). A hard reset also executes a SYNC operation, which brings the outputs into phase alignment according to the default settings. When EEPROM is inactive (the EEPROM pin = 0), it takes ~2  $\mu\text{s}$  for the outputs to begin toggling after  $\overline{\text{RESET}}$  is issued. When EEPROM is active (the EEPROM pin = 1), it takes ~20 ms for the outputs to toggle after  $\overline{\text{RESET}}$  is brought high.

### Soft Reset via the Serial Port

The serial port control register allows for a soft reset by setting Bit 2 and Bit 5 in Register 0x000. When Bit 5 and Bit 2 are set, the chip enters a soft reset mode and restores the chip either to the setting stored in EEPROM (the EEPROM pin = 1) or to the on-chip setting (the EEPROM pin = 0), except for Register 0x000.

Except for the self-clearing bits, Bit 2 and Bit 5, Register 0x000 retains its previous value prior to reset. During the internal reset, the outputs hold static. These bits are self-clearing. However, the self-clearing operation does not complete until an additional serial port SCLK cycle, and the AD9520 is held in reset until that happens.

### Soft Reset to Settings in EEPROM when EEPROM Pin = 0 via the Serial Port

The serial port control register allows the chip to be reset to settings in EEPROM when the EEPROM pin = 1 via 0xB02[1]. This bit is self-clearing. This bit does not have any effect when the EEPROM pin = 0. It takes ~20 ms for the outputs to begin toggling after the Soft\_EEPROM register is cleared.

## POWER-DOWN MODES

### Chip Power-Down via $\overline{\text{PD}}$

The AD9522 can be put into a power-down condition by pulling the  $\overline{\text{PD}}$  pin low. Power-down turns off most of the functions and currents inside the AD9522. The chip remains in this power-down state until  $\overline{\text{PD}}$  is brought back to logic high. When taken out of power-down mode, the AD9522 returns to the settings programmed into its registers prior to the power-down, unless the registers are changed by new programming while the  $\overline{\text{PD}}$  pin is held low.

Powering down the chip shuts down the currents on the chip. Because this is not a complete power-down, it can be called sleep mode. The AD9522 contains special circuitry to prevent runt pulses on the outputs when the chip is entering or exiting sleep mode.

When the AD9522 is in a  $\overline{\text{PD}}$  power-down, the chip is in the following state:

- The PLL is off (asynchronous power-down).
- The VCO is off.
- The CLK input buffer is off, but the CLK input dc bias circuit is on.
- In differential mode, the reference input buffer is off, but the dc bias circuit is still on.
- In singled-ended mode, the reference input buffer is off, and the dc bias circuit is off.
- All dividers are off.
- All CMOS outputs are tristated.
- All LVDS outputs are in power-down (high impedance) mode.
- The serial control port is active, and the chip responds to commands.



**PLL Power-Down**

The PLL section of the AD9522 can be selectively powered down. There are two PLL power-down modes set by Register 0x010[1:0]: asynchronous and synchronous.

In asynchronous power-down mode, the device powers down as soon as the registers are updated. In synchronous power-down mode, the PLL power-down is gated by the charge pump to prevent unwanted frequency jumps. The device goes into power-down on the occurrence of the next charge pump event after the registers are updated.

**Distribution Power-Down**

The distribution section can be powered down by writing 0x230[1] = 1b, which turns off the bias to the distribution section. If the LVDS power-down mode is normal operation (0b), it is possible for a low impedance load on that LVDS output to draw significant current during this power-down. If the LVDS power-down mode is set to 1b, the LVDS output is not protected from reverse bias and can be damaged under certain termination conditions.

**Individual Clock Output Power-Down**

Any of the clock distribution outputs can be put into power-down mode by individually writing to the appropriate registers. The register map details the individual power-down settings for each output. These settings are found in Register 0x0F0[0] to Register 0x0FB[0].

**Individual Clock Channel Power-Down**

Any of the clock distribution channels can be powered down individually by writing to the appropriate registers. Powering down a clock channel is similar to powering down an individual driver, but it saves more power because the dividers are also powered down. Powering down a clock channel also automatically powers down the drivers connected to it. The register map details the individual power-down settings for each output channel. These settings are found in 0x192[2], 0x195[2], 0x198[2], and 0x19B[2].

## SERIAL CONTROL PORT

The AD9522 serial control port is a flexible, synchronous serial communications port that allows an easy interface with many industry-standard microcontrollers and microprocessors. The AD9522 serial control port is compatible with most synchronous transfer formats, including Philips I<sup>2</sup>C, Motorola® SPI®, and Intel® SSR protocols. The AD9522 I<sup>2</sup>C implementation deviates from the classic I<sup>2</sup>C specification on two specifications, and these deviations are documented in Table 14 of this data sheet. The serial control port allows read/write access to all registers that configure the AD9522.

### SPI/I<sup>2</sup>C PORT SELECTION

The AD9522 has two serial interfaces, SPI and I<sup>2</sup>C. Users can select either SPI or I<sup>2</sup>C depending on the states of the three logic level (high, open, low) input pins, SP1 and SP0. When both SP1 and SP0 are high, the SPI interface is active. Otherwise, I<sup>2</sup>C is active with eight different I<sup>2</sup>C slave address (seven bits wide) settings, see Table 39. The four MSBs of the slave address are hardware coded as 1011, and the three LSBs are programmed by SP1 and SP0.

**Table 39. Serial Port Mode Selection**

SP1	SP0	Address
Low	Low	I <sup>2</sup> C, 1011000
Low	Open	I <sup>2</sup> C, 1011001
Low	High	I <sup>2</sup> C, 1011010
Open	Low	I <sup>2</sup> C, 1011011
Open	Open	I <sup>2</sup> C, 1011100
Open	High	I <sup>2</sup> C, 1011101
High	Low	I <sup>2</sup> C, 1011110
High	Open	I <sup>2</sup> C, 1011111
High	High	SPI

### I<sup>2</sup>C SERIAL PORT OPERATION

The AD9522 I<sup>2</sup>C port is based on the I<sup>2</sup>C fast mode standard. The AD9522 supports both I<sup>2</sup>C protocols: standard mode (100 kHz) and fast mode (400 kHz).

The AD9522 I<sup>2</sup>C port has a 2-wire interface consisting of a serial data line (SDA) and a serial clock line (SCL). In an I<sup>2</sup>C bus system, the AD9522 is connected to the serial bus (data bus SDA and clock bus SCL) as a slave device, meaning that no clock is generated by the AD9522. The AD9522 uses direct 16-bit (two bytes) memory addressing instead of traditional 8-bit (one byte) memory addressing.

### I<sup>2</sup>C Bus Characteristics

**Table 40. I<sup>2</sup>C Bus Definitions**

Abbreviation	Definition
S	Start
Sr	Repeated start
P	Stop
A	Acknowledge
$\bar{A}$	No acknowledge
W	Write
R	Read

One pulse on the SCL clock line is generated for each data bit transferred.

The data on the SDA line must not change during the high period of the clock. The state of the data line can change only when the clock on the SCL line is low.

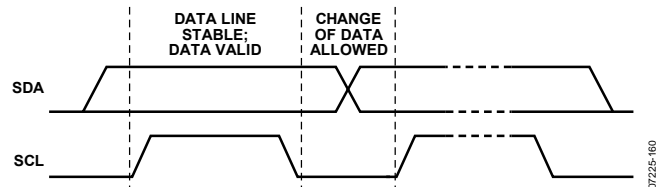

Figure 56. Valid Bit Transfer

A start condition is a transition from high to low on the SDA line while SCL is high. The start condition is always generated by the master to initialize the data transfer.

A stop condition is a transition from low to high on the SDA line while SCL is high. The stop condition is always generated by the master to end the data transfer.

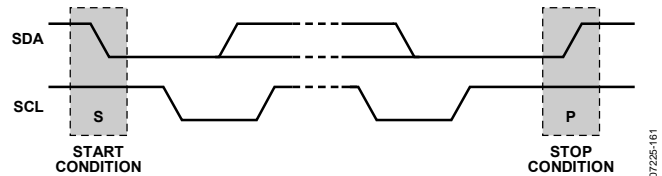

Figure 57. Start and Stop Conditions

A byte on the SDA line is always eight bits long. An acknowledge bit must follow every byte. Bytes are sent MSB first.

The acknowledge bit is the ninth bit attached to any 8-bit data byte. An acknowledge bit is always generated by the receiving device (receiver) to inform the transmitter that the byte has been received. It is done by pulling the SDA line low during the ninth clock pulse after each 8-bit data byte.

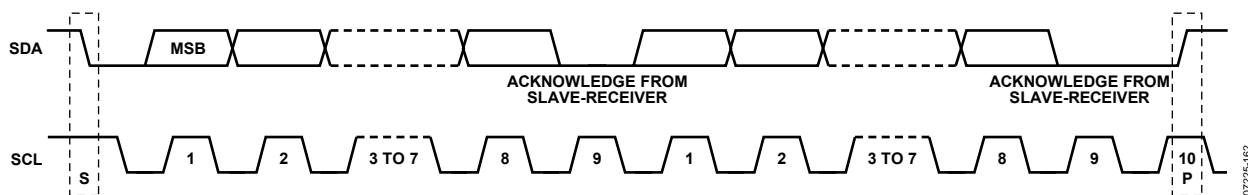

Figure 58. Acknowledge Bit

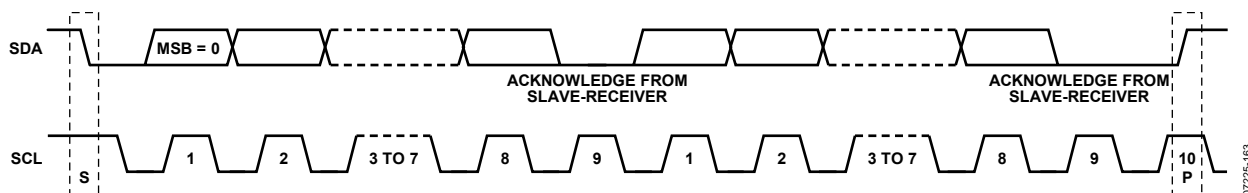

Figure 59. Data Transfer Process (Master Write Mode, 2-Byte Transfer Used for Illustration)

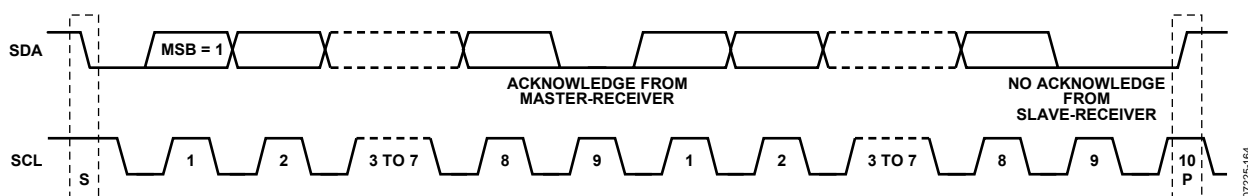

Figure 60. Data Transfer Process (Master Read Mode, 2-Byte Transfer Used for Illustration)

The no acknowledge bit is the ninth bit attached to any 8-bit data byte. A no acknowledge bit is always generated by the receiving device (receiver) to inform the transmitter that the byte has not been received. It is done by leaving the SDA line high during the ninth clock pulse after each 8-bit data byte.

### Data Transfer Process

The master initiates data transfer by asserting a start condition. This indicates that a data stream follows. All I<sup>2</sup>C slave devices connected to the serial bus respond to the start condition.

The master then sends an 8-bit address byte over the SDA line, consisting of a 7-bit slave address (MSB first) plus an R/W bit. This bit determines the direction of the data transfer, that is, whether data is written to or read from the slave device (0 = write, 1 = read).

The peripheral whose address corresponds to the transmitted address responds by sending an acknowledge bit. All other devices on the bus remain idle while the selected device waits for data to be read from or written to it. If the R/W bit is 0, the master (transmitter) writes to the slave device (receiver). If the R/W bit is 1, the master (receiver) reads from the slave device (transmitter).

The format for these commands is described in the Data Transfer Format section.

Data is then sent over the serial bus in the format of nine clock pulses, one data byte (8-bit) from either master (write mode) or slave (read mode) followed by an acknowledge bit from the receiving device. The number of bytes that can be transmitted per transfer is unrestricted. In write mode, the first two data bytes immediately after the slave address byte are the internal memory (control registers) address bytes with the high address byte first. This addressing scheme gives a memory address up to  $2^{16} - 1 = 65,535$ . The data bytes after these two memory address bytes are register data written into the control registers. In read mode, the data bytes after the slave address byte are register data read from the control registers.

When all data bytes are read or written, stop conditions are established. In write mode, the master (transmitter) asserts a stop condition to end data transfer during the (10th) clock pulse following the acknowledge bit for the last data byte from the slave device (receiver). In read mode, the master device (receiver) receives the last data byte from the slave device (transmitter) but does not pull it low during the ninth clock pulse. This is known as a no acknowledge bit. By receiving the no acknowledge bit, the slave device knows that the data transfer is finished and releases the SDA line. The master then takes the data line low during the low period before the 10th clock pulse and high during the 10th clock pulse to assert a stop condition.

A repeated start (Sr) condition can be used in place of a stop condition. Furthermore, a start or stop condition can occur at any time, and partially transferred bytes are discarded.

# AD9522-4

## Data Transfer Format

Send byte format—the send byte protocol is used to set up the register address for subsequent commands.

S	Slave Address	W	A	RAM Address High Byte	A	RAM Address Low Byte	A	P
---	---------------	---	---	-----------------------	---	----------------------	---	---

Write byte format—the write byte protocol is used to write a register address to the RAM starting from the specified RAM address.

S	Slave Address	W	A	RAM Address High Byte	A	RAM Address Low Byte	A	RAM Data 0	A	RAM Data 1	A	RAM Data 2	A	P
---	---------------	---	---	-----------------------	---	----------------------	---	------------	---	------------	---	------------	---	---

Receive byte format—the receive byte protocol is used to read the data byte(s) from RAM starting from the current address.

S	Slave Address	R	A	RAM Data 0	A	RAM Data 1	A	RAM Data 2	$\bar{A}$	P
---	---------------	---	---	------------	---	------------	---	------------	-----------	---

Read byte format—the combined format of the send byte and the receive byte.

S	Slave Address	W	A	RAM Address High Byte	A	RAM Address Low Byte	A	Sr	Slave Address	R	A	RAM Data 0	A	RAM Data 1	A	RAM Data 2	$\bar{A}$	P
---	---------------	---	---	-----------------------	---	----------------------	---	----	---------------	---	---	------------	---	------------	---	------------	-----------	---

## I<sup>2</sup>C Serial Port Timing

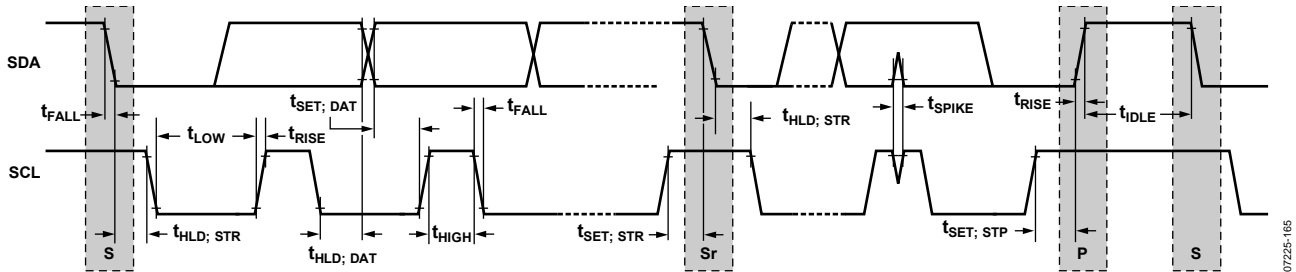

Figure 61. I<sup>2</sup>C Serial Port Timing

Table 41. I<sup>2</sup>C Timing Definitions

Parameter	Description
$f_{I2C}$	I <sup>2</sup> C clock frequency
$t_{IDLE}$	Bus idle time between stop and start conditions
$t_{HLD; STR}$	Hold time for repeated start condition
$t_{SET; STR}$	Setup time for repeated start condition
$t_{SET; STP}$	Setup time for stop condition
$t_{HLD; DAT}$	Hold time for data
$t_{SET; DAT}$	Setup time for data
$t_{LOW}$	Duration of SCL clock low
$t_{HIGH}$	Duration of SCL clock high
$t_{RISE}$	SCL/SDA rise time
$t_{FALL}$	SCL/SDA fall time
$t_{SPIKE}$	Voltage spike pulse width that must be suppressed by the input filter

## SPI SERIAL PORT OPERATION

### Pin Descriptions

SCLK (serial clock) is the serial shift clock. This pin is an input. SCLK is used to synchronize serial control port reads and writes. Write data bits are registered on the rising edge of this clock, and read data bits are registered on the falling edge. This pin is internally pulled down by a 30 k $\Omega$  resistor to ground.

SDIO (serial data input/output) is a dual-purpose pin and acts either as an input only (unidirectional mode) or as an input/output (bidirectional mode). The AD9522 defaults to the bidirectional I/O mode (0x000[7] = 0b).

SDO (serial data out) is used only in the unidirectional I/O mode (0x000[7] = 1b) as a separate output pin for reading back data.

$\overline{\text{CS}}$  (chip select bar) is an active low control that gates the read and write cycles. When  $\overline{\text{CS}}$  is high, SDO and SDIO are in a high impedance state. This pin is internally pulled up by a 30 k $\Omega$  resistor to VS.

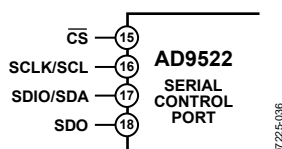

Figure 62. Serial Control Port

### SPI Mode Operation

In SPI mode, single or multiple byte transfers are supported, as well as MSB first or LSB first transfer formats. The AD9522 serial control port can be configured for a single bidirectional I/O pin (SDIO only) or for two unidirectional I/O pins (SDIO/SDO). By default, the AD9522 is in bidirectional mode. Short instruction mode (8-bit instructions) is not supported. Only long (16-bit) instruction mode is supported.

A write or a read operation to the AD9522 is initiated by pulling  $\overline{\text{CS}}$  low.

The  $\overline{\text{CS}}$  stalled high mode is supported in data transfers where three or fewer bytes of data (plus instruction data) are transferred (see Table 42). In this mode, the  $\overline{\text{CS}}$  pin can temporarily return high on any byte boundary, allowing time for the system controller to process the next byte.  $\overline{\text{CS}}$  can go high on byte boundaries only and can go high during either part (instruction or data) of the transfer.

During this period, the serial control port state machine enters a wait state until all data is sent. If the system controller decides to abort the transfer before all of the data is sent, the state machine must be reset by either completing the remaining transfers or by returning  $\overline{\text{CS}}$  low for at least one complete SCLK cycle (but fewer than eight SCLK cycles). Raising the  $\overline{\text{CS}}$  pin on a nonbyte boundary terminates the serial transfer and flushes the buffer.

In the streaming mode (see Table 42), any number of data bytes can be transferred in a continuous stream. The register address is automatically incremented or decremented (see the SPI MSB/LSB First Transfers section).  $\overline{\text{CS}}$  must be raised at the end of the last byte to be transferred, thereby ending streaming mode.

### Communication Cycle—Instruction Plus Data

There are two parts to a communication cycle with the AD9522. The first part writes a 16-bit instruction word into the AD9522, coincident with the first 16 SCLK rising edges. The instruction word provides the AD9522 serial control port with information regarding the data transfer, which is the second part of the communication cycle. The instruction word defines whether the upcoming data transfer is a read or a write, the number of bytes in the data transfer, and the starting register address for the first byte of the data transfer.

#### Write

If the instruction word is for a write operation, the second part is the transfer of data into the serial control port buffer of the AD9522. Data bits are registered on the rising edge of SCLK.

The length of the transfer (one, two, or three bytes, or streaming mode) is indicated by two bits (W1:W0) in the instruction byte. When the transfer is one, two, or three bytes, but not streaming,  $\overline{\text{CS}}$  can be raised after each sequence of eight bits to stall the bus (except after the last byte, where it ends the cycle). When the bus is stalled, the serial transfer resumes when  $\overline{\text{CS}}$  is lowered. Raising the  $\overline{\text{CS}}$  pin on a nonbyte boundary resets the serial control port. During a write, streaming mode does not skip over reserved or blank registers, and the user can write 0x00 to the reserved register addresses.

Because data is written into a serial control port buffer area, not directly into the actual control registers of the AD9522, an additional operation is needed to transfer the serial control port buffer contents to the actual control registers of the AD9522, thereby causing them to become active. The update registers operation consists of setting 0x232[0] = 1b (this bit is self-clearing). Any number of bytes of data can be changed before executing an update registers. The update registers simultaneously actuates all register changes that have been written to the buffer since any previous update.

#### Read

The AD9522 supports only the long instruction mode. If the instruction word is for a read operation, the next  $N \times 8$  SCLK cycles clock out the data from the address specified in the instruction word, where N is 1 to 3 as determined by W1:W0. If N = 4, the read operation is in streaming mode, continuing until  $\overline{\text{CS}}$  is raised. Streaming mode does not skip over reserved or blank registers. The readback data is valid on the falling edge of SCLK.

# AD9522-4

The default mode of the AD9522 serial control port is the bidirectional mode. In bidirectional mode, both the sent data and the readback data appear on the SDIO pin. It is also possible to set the AD9522 to unidirectional mode (0x000[7] = 1 and 0x000[0] = 1). In unidirectional mode, the readback data appears on the SDO pin.

A readback request reads the data that is in the serial control port buffer area or the data that is in the active registers (see Figure 63). Readback of the buffer or active registers is controlled by 0x004[0].

The AD9522 uses Register Address 0x000 to Register Address 0xB03.

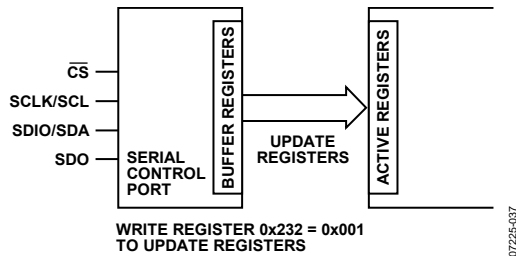

Figure 63. Relationship Between Serial Control Port Buffer Registers and Active Registers of the AD9522

## SPI INSTRUCTION WORD (16 BITS)

The MSB of the instruction word is  $R/\overline{W}$ , which indicates whether the instruction is a read or a write. The next two bits (W1:W0) indicate the length of the transfer in bytes. The final 13 bits are the address (A12:A0) at which to begin the read or write operation.

For a write, the instruction word is followed by the number of bytes of data indicated by Bits[W1:W0], see Table 42.

Table 42. Byte Transfer Count

W1	W0	Bytes to Transfer
0	0	1
0	1	2
1	0	3
1	1	Streaming mode

Bits[A12:A0] select the address within the register map that is written to or read from during the data transfer portion of the communications cycle. Only Bits[A9:A0] are needed to cover the range of the 0x232 registers used by the AD9522. Bits[A12:A10] must always be 0b. For multibyte transfers, this address is the starting byte address. In MSB first mode, subsequent bytes increment the address.

## SPI MSB/LSB FIRST TRANSFERS

The AD9522 instruction word and byte data can be MSB first or LSB first. Any data written to 0x000 must be mirrored; the upper four bits ([7:4]) must mirror the lower four bits ([3:0]). This makes it irrelevant whether LSB first or MSB first is in effect. As an example of this mirroring, see the default setting for 0x000, which mirrors Bit 4 and Bit 3. This sets the long instruction mode, which is the default and the only mode supported.

The default for the AD9522 is MSB first.

When LSB first is set by 0x000[1] and 0x000[6], it takes effect immediately because it only affects the operation of the serial control port and does not require that an update be executed.

When MSB first mode is active, the instruction and data bytes must be written from MSB to LSB. Multibyte data transfers in MSB first format start with an instruction byte that includes the register address of the most significant data byte. Subsequent data bytes must follow in order from the high address to the low address. In MSB first mode, the serial control port internal address generator decrements for each data byte of the multibyte transfer cycle.

When LSB first is active, the instruction and data bytes must be written from LSB to MSB. Multibyte data transfers in LSB first format start with an instruction byte that includes the register address of the least significant data byte followed by multiple data bytes. In a multibyte transfer cycle, the internal byte address generator of the serial port increments for each byte.

The AD9522 serial control port register address decrements from the register address just written toward 0x000 for multibyte I/O operations if the MSB first mode is active (default). If the LSB first mode is active, the register address of the serial control port increments from the address just written toward 0x232 for multibyte I/O operations.

Streaming mode always terminates when it reaches 0x232. Note that unused addresses are not skipped during multibyte I/O operations.

Table 43. Streaming Mode (No Addresses Are Skipped)

Write Mode	Address Direction	Stop Sequence
LSB first	Increment	0x230, 0x231, 0x232, stop
MSB first	Decrement	0x001, 0x000, 0x232, stop

Table 44. Serial Control Port, 16-Bit Instruction Word, MSB First

MSB														LSB	
I15	I14	I13	I12	I11	I10	I9	I8	I7	I6	I5	I4	I3	I2	I1	I0
R/W	W1	W0	A12 = 0	A11 = 0	A10 = 0	A9	A8	A7	A6	A5	A4	A3	A2	A1	A0

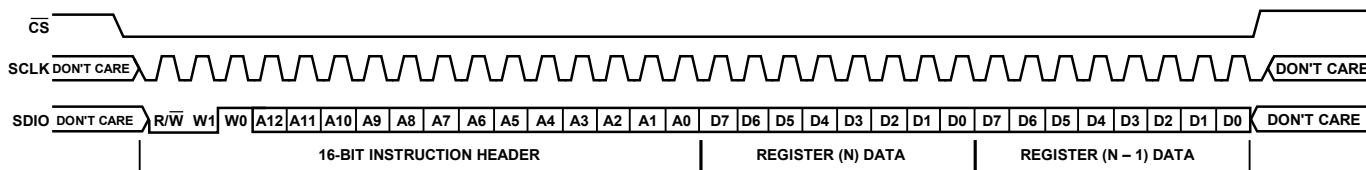

Figure 64. Serial Control Port Write—MSB First, 16-Bit Instruction, Two Bytes of Data

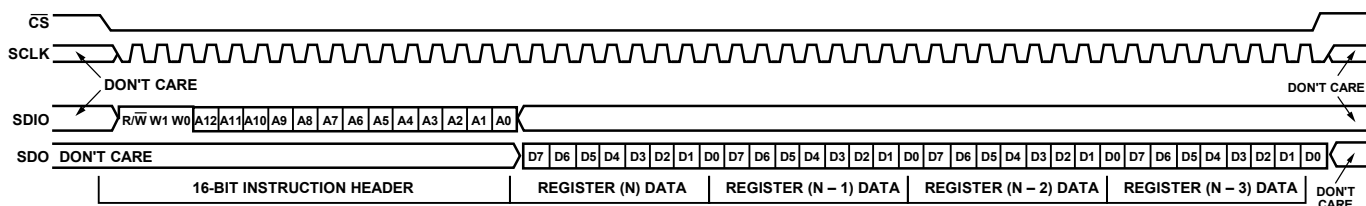

Figure 65. Serial Control Port Read—MSB First, 16-Bit Instruction, Four Bytes of Data

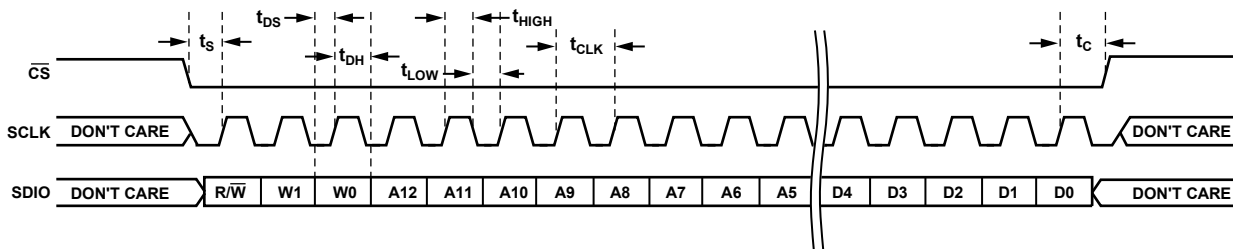

Figure 66. Serial Control Port Write—MSB First, 16-Bit Instruction, Timing Measurements

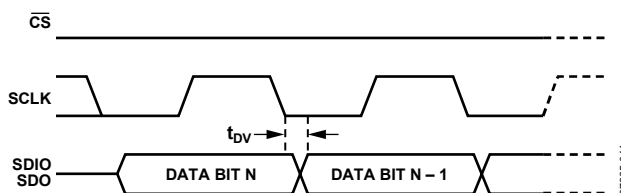

Figure 67. Timing Diagram for Serial Control Port Register Read

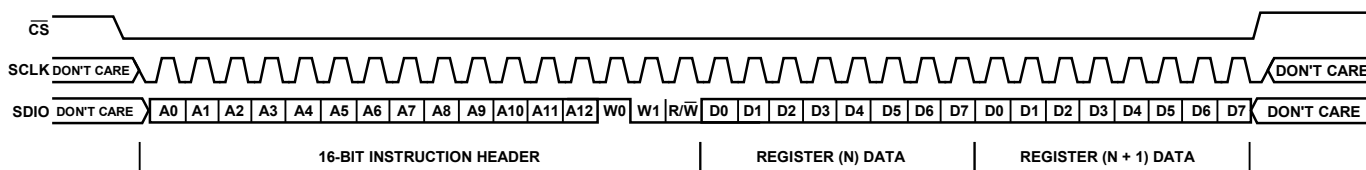

Figure 68. Serial Control Port Write—LSB First, 16-Bit Instruction, Two Bytes of Data

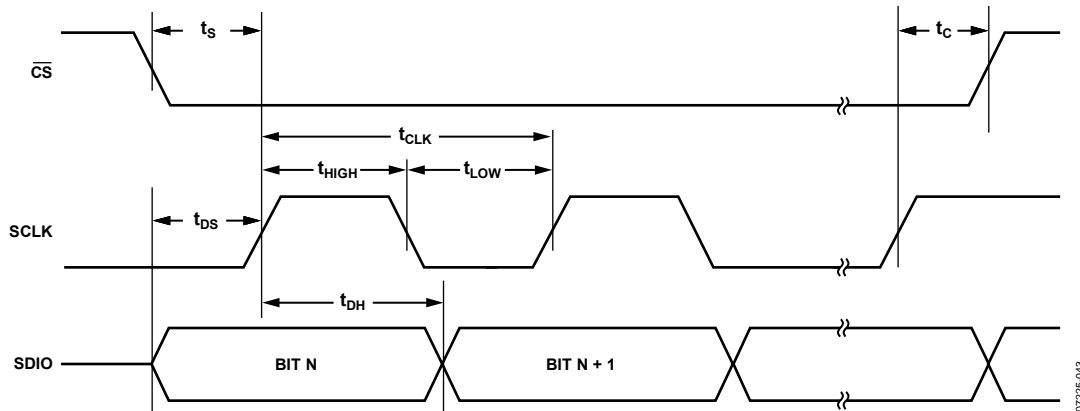

Figure 69. Serial Control Port Timing—Write

07225-043

Table 45. Serial Control Port Timing

Parameter	Description
$t_{DS}$	Setup time between data and rising edge of SCLK
$t_{DH}$	Hold time between data and rising edge of SCLK
$t_{CLK}$	Period of the clock
$t_s$	Setup time between the $\overline{CS}$ falling edge and SCLK rising edge (start of communication cycle)
$t_c$	Setup time between SCLK rising edge and the $\overline{CS}$ rising edge (end of communication cycle)
$t_{HIGH}$	Minimum period that SCLK should be in a logic high state
$t_{LOW}$	Minimum period that SCLK should be in a logic low state
$t_{DV}$	SCLK to valid SDIO and SDO (see Figure 67)



## EEPROM OPERATIONS

The AD9522 contains an internal EEPROM (nonvolatile memory). The EEPROM can be programmed by users to create and store a user-defined register setting file when the power is off. This setting file can be used for power-up and chip reset as a default setting. The EEPROM size is 512 bytes.

During the data transfer process, the write and read registers via the serial port are generally not available except for one readback register, STATUS\_EEPROM.

To determine the data transfer state through the serial port in SPI mode, users can read the value of STATUS\_EEPROM (1 = in process and 0 = completed).

In I<sup>2</sup>C mode, the user can address the AD9522 slave port with the external I<sup>2</sup>C master (send an address byte to the AD9522). If the AD9522 responds with a no acknowledge bit, the data transfer process is not done. If the AD9522 responds with an acknowledge bit, the data transfer process is completed. The user can monitor the STATUS\_EEPROM register or program the STATUS pin to monitor the status of the data transfer.

### WRITING TO THE EEPROM

The EEPROM cannot be programmed directly through the serial port interface. To program the EEPROM and store a register setting file, do the following:

1. Program the AD9522 registers to the desired circuit state. If the user wants the PLL to lock automatically after power-up, the VCO calibration now bit (0x018[0]) must be set to 1. This allows VCO calibration to start automatically after register loading. Note that a valid input reference signal must be present during VCO calibration.
2. Program the EEPROM buffer registers, if necessary (see the Programming the EEPROM Buffer Segment section).

This is only necessary if users want to use the EEPROM to control the default setting of some (but not all) of the AD9522 registers, or if they want to control the register setting update sequence during power-up or chip reset.

3. Set the enable EEPROM write bit (0xB02[0]) to 1 to enable the EEPROM.
4. Set the REG2EEPROM bit (0xB03[0]) to 1.
5. Set the IO\_UPDATE bit (0x232[0]) to 1, which starts the process of writing data into the EEPROM to create the EEPROM setting file. This enables the AD9522 EEPROM controller to transfer the current register values, as well as the memory address and instruction bytes, from the EEPROM buffer segment, into the EEPROM. After the write process is completed, the internal controller sets 0xB03[0] (REG2EEPROM) back to 0.

The readback register, STATUS\_EEPROM (0xB00[0]), is used to indicate the data transfer status between the EEPROM and the control registers (0 = done/inactive; 1 = in process/active). At the beginning of the data transfer, STATUS\_EEPROM is set to 1 by the EEPROM controller and cleared to 0 at the end of the data transfer. The user can access STATUS\_EEPROM through the STATUS pin when the STATUS pin is programmed to monitor STATUS\_EEPROM. Alternatively, the user can monitor the STATUS\_EEPROM bit.

6. After the data transfer process is done (0xB00[0] = 0), set the enable EEPROM write register (0xB02[0]) to 0 to disable writing to the EEPROM.

To verify that the data transfer has completed correctly, the user can verify that 0xB01[0] = 0. A value of 1 in this register indicates a data transfer error.

### READING FROM THE EEPROM

The following reset-related events can start the process of restoring the settings stored in EEPROM to control registers.

When the EEPROM pin is set high, do any of the following:

1. Power up the AD9522.
2. Perform a hardware chip reset by pulling the RESET pin low and then releasing RESET.
3. Set the self-clearing soft reset bit (0x000[5]) to 1.

When the EEPROM pin is set low, set the self-clearing Soft\_EEPROM bit (0xB02[1]) to 1. The AD9522 then starts to read the EEPROM and loads the values into the AD9522.

If the EEPROM pin is low during reset or power-up, the EEPROM is not active, and the AD9522 default values are loaded instead.

When using the EEPROM to automatically load the AD9522 register values and lock the PLL, the VCO calibration now bit (0x018[0]) must be set to 1 when the register values are written to the EEPROM. This allows VCO calibration to start automatically after register loading. A valid input reference signal must be present during VCO calibration.

To verify that the data transfer has completed correctly, the user can verify that 0xB01[0] = 0. A value of 1 in this register indicates a data transfer error.

## PROGRAMMING THE EEPROM BUFFER SEGMENT

The EEPROM buffer segment is a register space on the AD9522 that allows the user to specify which groups of registers are stored to the EEPROM during EEPROM programming. Normally, this segment does not need to be programmed by the user. Instead, the default power-up values for the EEPROM buffer segment allow the user to store all of the AD9522 register values from Register 0x000 to Register 0x231 to the EEPROM.

For example, if users want to load only the output driver settings from the EEPROM without disturbing the PLL register settings currently stored in the AD9522, they can alter the EEPROM buffer segment to include only the registers that apply to the output drivers and exclude the registers that apply to the PLL configuration.

There are two parts to the EEPROM buffer segment: register section definition groups and operational codes. Each register section definition group contains the starting address and number of bytes to be written to the EEPROM.

If the AD9522 register map were continuous from Address 0x000 to Address 0x232, only one register section definition group would consist of a starting address of 0x000 and a length of 563 bytes. However, this is not the case. The AD9522 register map is noncontiguous, and the EEPROM is only 512 bytes long. Therefore, the register section definition group tells the EEPROM controller how the AD9522 register map is segmented.

There are three operational codes: IO\_UPDATE, end-of-data, and pseudo-end-of-data. It is important that the EEPROM buffer segment always have either an end-of-data or a pseudo-end-of-data operational code and that an IO\_UPDATE operation code appear at least once before the end-of-data op code.

### **Register Section Definition Group**

The register section definition group is used to define a continuous register section for the EEPROM profile. It consists of three bytes. The first byte defines how many continuous register bytes are in this group. If the user puts 0x000 in the first byte, it means there is only one byte in this group. If the user puts 0x001, it means there are two bytes in this group. The maximum number of registers in one group is 128.

The next two bytes are the low byte and high byte of the memory address (16-bit) of the first register in this group.

### **IO\_UPDATE (Operational Code 0x80)**

The EEPROM controller uses Operational Code 0x80 to generate an IO\_UPDATE signal to update the active control register bank from the buffer register bank during the download process.

At a minimum, there should be at least one IO\_UPDATE operational code after the end of the final register section definition group. This is needed so that at least one IO\_UPDATE occurs after all of the AD9522 registers are loaded when the EEPROM is read. If this operational code is absent during a write to the EEPROM, the register values loaded from the EEPROM are not transferred to the active register space, and these values do not take effect after they are loaded from the EEPROM to the AD9522.

### **End-of-Data (Operational Code 0xFF)**

The EEPROM controller uses Operational Code 0xFF to terminate the data transfer process between EEPROM and the control register during the upload and download process. The last item appearing in the EEPROM buffer segment should be either this operational code or the pseudo-end-of-data operational code.

### **Pseudo-End-of-Data (Operational Code 0xFE)**

The AD9522 EEPROM buffer segment has 23 bytes that can contain up to seven register section definition groups. If users want to define more than seven register section definition groups, the pseudo-end-of-data operational code (0xFE) can be used. During the upload process, when the EEPROM controller receives the pseudo-end-of-data operational code, it halts the data transfer process, clears the REG2EEPROM bit, and enables the AD9522 serial port. Users can then program the EEPROM buffer segment again and reinitiate the data transfer process by setting the REG2EEPROM bit (0xB03) to 1 and the IO\_UPDATE register (0x232) to 1. The internal I<sup>2</sup>C master then begins writing to the EEPROM starting from the EEPROM address held from the last writing.

This sequence enables more discrete instructions to be written to the EEPROM than would otherwise be possible due to the limited size of the EEPROM buffer segment. It also permits the user to write to the same register multiple times with a different value each time.

Table 46. Example of EEPROM Buffer Segment

Reg Addr (Hex)	Bit 7 (MSB)	Bit 6	Bit 5	Bit 4	Bit 3	Bit 2	Bit 1	Bit 0 (LSB)
<b>Start EEPROM Buffer Segment</b>								
0xA00	0	Number of bytes [6:0] of the first group of registers						
0xA01	Address [15:8] of the first group of registers							
0xA02	Address [7:0] of the first group of registers							
0xA03	0	Number of bytes [6:0] of the second group of registers						
0xA04	Address [15:8] of the second group of registers							
0xA05	Address [7:0] of the second group of registers							
0xA06	0	Number of bytes [6:0] of the third group of registers						
0xA07	Address [15:8] of the third group of registers							
0xA08	Address [7:0] of the third group of registers							
0xA09	IO_UPDATE operational code (0x80)							
0xA0A	End-of-data operational code (0xFF)							

## THERMAL PERFORMANCE

Table 47. Thermal Parameters for the 64-Lead LFCSP

Symbol	Thermal Characteristic Using a JEDEC JESD51-7 Plus JEDEC JESD51-5 2S2P Test Board	Value (°C/W)
$\theta_{JA}$	Junction-to-ambient thermal resistance, 0.0 m/sec airflow per JEDEC JESD51-2 (still air)	22.0
$\theta_{JMA}$	Junction-to-ambient thermal resistance, 1.0 m/sec airflow per JEDEC JESD51-6 (moving air)	19.2
$\theta_{JMA}$	Junction-to-ambient thermal resistance, 2.0 m/sec airflow per JEDEC JESD51-6 (moving air)	17.2
$\Psi_{JB}$	Junction-to-board characterization parameter, 1.0 m/sec airflow per JEDEC JESD51-6 (moving air) and JEDEC JESD51-8	11.6
$\theta_{JC}$	Junction-to-case thermal resistance (die-to-heat sink) per MIL-Std 883, Method 1012.1	1.3
$\Psi_{JT}$	Junction-to-top-of-package characterization parameter, 0 m/sec airflow per JEDEC JESD51-2 (still air)	0.1

The AD9522 is specified for a case temperature ( $T_{CASE}$ ). To ensure that  $T_{CASE}$  is not exceeded, an airflow source can be used.

Use the following equation to determine the junction temperature on the application PCB:

$$T_J = T_{CASE} + (\Psi_{JT} \times PD)$$

where:

$T_J$  is the junction temperature (°C).

$T_{CASE}$  is the case temperature (°C) measured by the user at the top center of the package.

$\Psi_{JT}$  is the value from Table 47.

$PD$  is the power dissipation (see the total power dissipation in Table 18.)

Values of  $\theta_{JA}$  are provided for package comparison and PCB design considerations.  $\theta_{JA}$  can be used for a first-order approximation of  $T_J$  by the equation

$$T_J = T_A + (\theta_{JA} \times PD)$$

where  $T_A$  is the ambient temperature (°C).

Values of  $\theta_{JC}$  are provided for package comparison and PCB design considerations when an external heat sink is required.

Values of  $\Psi_{JB}$  are provided for package comparison and PCB design considerations.

## REGISTER MAP

Register addresses that are not listed in Table 48 are not used, and writing to those registers has no effect. Writing to register addresses marked unused should have 00h written to them, unless otherwise noted.

**Table 48. Register Map Overview**

Addr (Hex)	Parameter	Bit 7 (MSB)	Bit 6	Bit 5	Bit 4	Bit 3	Bit 2	Bit 1	Bit 0 (LSB)	Default Value (Hex)	
<b>Serial Port Configuration</b>											
000	Serial port config (SPI mode)	SDO active	LSB first/ addr incr	Soft reset (self-clearing)	Unused	Unused	Soft reset (self-clearing)	LSB first/ addr incr	SDO active	00	
	Serial port config (I <sup>2</sup> C mode)	Unused		Soft reset (self-clearing)	Unused	Unused	Soft reset (self-clearing)	Unused		00	
001		Unused								N/A	
002		Reserved (read-only)								N/A	
003		Reserved (read-only)								N/A	
004	Readback control	Unused							Readback active regs	00	
<b>EEPROM ID</b>											
005	EEPROM customer version ID	EEPROM customer version ID (LSB)								00	
006		EEPROM customer version ID (MSB)								00	
007 to 00F		Unused								00	
<b>PLL</b>											
010	PFD charge pump	PFD polarity	Charge pump current			Charge pump mode		PLL power-down		7D	
011	R counter	14-bit R counter, Bits[7:0] (LSB)								01	
012		Unused	14-bit R counter, Bits[13:8] (MSB)						00		
013	A counter	Unused	6-bit A counter								00
014	B counter	13-bit B counter, Bits[7:0] (LSB)								03	
015		Unused	13-bit B counter, Bits[12:8] (MSB)						00		
016	PLL_CTRL_1	Set CP pin to VCP/2	Reset R counter	Reset A and B counters	Reset all counters	B counter bypass	Prescaler P			06	
017	PLL_CTRL_2	STATUS pin control						Antibacklash pulse width		00	
018	PLL_CTRL_3	Enable CMOS reference input dc offset	Lock detect counter		Digital lock detect window	Disable digital lock detect	VCO calibration divider		VCO calibration now	06	
019	PLL_CTRL_4	R, A, B counters SYNC pin reset		R path delay			N path delay			00	
01A	PLL_CTRL_5	Enable STATUS pin divider	Ref freq monitor threshold	LD pin control							00
01B	PLL_CTRL_6	Enable VCO frequency monitor	Enable REF2 (REFIN) frequency monitor	Enable REF1 (REFIN) frequency monitor	REFMON pin control						00
01C	PLL_CTRL_7	Disable switchover deglitch	Select REF2	Use REF_SEL pin	Enable automatic reference switchover	Stay on REF2	Enable REF2	Enable REF1	Enable differential reference	00	
01D	PLL_CTRL_8	Enable Status_EEPROM at STATUS pin	Enable XTAL OSC	Enable clock doubler	Disable PLL status register	Enable LD pin comparator	Unused	Enable external holdover	Enable holdover	80	

# AD9522-4

Addr (Hex)	Parameter	Bit 7 (MSB)	Bit 6	Bit 5	Bit 4	Bit 3	Bit 2	Bit 1	Bit 0 (LSB)	Default Value (Hex)
01E	PLL_CTRL_9	Unused			External zero delay feedback channel divider select		Enable external zero delay	Enable zero delay	Unused	00
01F	PLL_Readback (read-only)	Unused	VCO cal finished	Holdover active	REF2 selected	VCO freq > threshold	REF2 freq > threshold	REF1 freq > threshold	Digital lock detect	N/A

## Output Driver Control

0F0	OUT0 control	OUT0 format	OUT0 CMOS configuration		OUT0 polarity		OUT0 LVDS differential voltage		OUT0 LVDS power-down	62
0F1	OUT1 control	OUT1 format	OUT1 CMOS configuration		OUT1 polarity		OUT1 LVDS differential voltage		OUT1 LVDS power-down	62
0F2	OUT2 control	OUT2 format	OUT2 CMOS configuration		OUT2 polarity		OUT2 LVDS differential voltage		OUT2 LVDS power-down	62
0F3	OUT3 control	OUT3 format	OUT3 CMOS configuration		OUT3 polarity		OUT3 LVDS differential voltage		OUT3 LVDS power-down	62
0F4	OUT4 control	OUT4 format	OUT4 CMOS configuration		OUT4 polarity		OUT4 LVDS differential voltage		OUT4 LVDS power-down	62
0F5	OUT5 control	OUT5 format	OUT5 CMOS configuration		OUT5 polarity		OUT5 LVDS differential voltage		OUT5 LVDS power-down	62
0F6	OUT6 control	OUT6 format	OUT6 CMOS configuration		OUT6 polarity		OUT6 LVDS differential voltage		OUT6 LVDS power-down	62
0F7	OUT7 control	OUT7 format	OUT7 CMOS configuration		OUT7 polarity		OUT7 LVDS differential voltage		OUT7 LVDS power-down	62
0F8	OUT8 control	OUT8 format	OUT8 CMOS configuration		OUT8 polarity		OUT8 LVDS differential voltage		OUT8 LVDS power-down	62
0F9	OUT9 control	OUT9 format	OUT9 CMOS configuration		OUT9 polarity		OUT9 LVDS differential voltage		OUT9 LVDS power-down	62
0FA	OUT10 control	OUT10 format	OUT10 CMOS configuration		OUT10 polarity		OUT10 LVDS differential voltage		OUT10 LVDS power-down	62
0FB	OUT11 control	OUT11 format	OUT11 CMOS configuration		OUT11 polarity		OUT11 LVDS differential voltage		OUT11 LVDS power-down	62
0FC	Enable output on CSDL D	CSDL D En OUT7	CSDL D En OUT6	CSDL D En OUT5	CSDL D En OUT4	CSDL D En OUT3	CSDL D En OUT2	CSDL D En OUT1	CSDL D En OUT0	00
0FD	Enable output on CSDL D	Unused	Unused	Unused	Unused	CSDL D En OUT11	CSDL D En OUT10	CSDL D En OUT9	CSDL D En OUT8	00
0FE to 18F		Unused								00

## LVDS Channel Dividers

190	Divider 0 (PECL)	Divider 0 low cycles				Divider 0 high cycles				77
191		Divider 0 bypass	Divider 0 ignore SYNC	Divider 0 force high	Divider 0 start high	Divider 0 phase offset				00
192		Unused				Unused	Channel 0 power-down	Reserved	Disable Divider 0 DCC	00

Addr (Hex)	Parameter	Bit 7 (MSB)	Bit 6	Bit 5	Bit 4	Bit 3	Bit 2	Bit 1	Bit 0 (LSB)	Default Value (Hex)
193	Divider 1 (PECL)	Divider 1 low cycles				Divider 1 high cycles				33
194		Divider 1 bypass	Divider 1 ignore SYNC	Divider 1 force high	Divider 1 start high	Divider 1 phase offset				00
195		Unused				Unused	Channel 1 power-down	Reserved	Disable Divider 1 DCC	00
196	Divider 2 (PECL)	Divider 2 low cycles				Divider 2 high cycles				11
197		Divider 2 bypass	Divider 2 ignore SYNC	Divider 2 force high	Divider 2 start high	Divider 2 phase offset				00
198		Unused				Unused	Channel 2 power-down	Reserved	Disable Divider 2 DCC	00
199	Divider 3 (PECL)	Divider 3 low cycles				Divider 3 high cycles				00
19A		Divider 3 bypass	Divider 3 ignore SYNC	Divider 3 force high	Divider 3 start high	Divider 3 phase offset				00
19B		Unused				Unused	Channel 3 power-down	Reserved	Disable Divider 3 DCC	00
19C to 1DF		Unused								00
<b>VCO Divider and CLK Input</b>										
1E0	VCO divider	Unused			Unused	VCO divider				00
1E1	Input CLKs	Unused		Power - down clock input section	Power-down VCO clock interface	Power-down VCO and CLK	Select VCO or CLK	Bypass VCO divider		00
1E2 to 22A		Unused								00
<b>System</b>										
230	Power-down and SYNC	Unused			Disable power-on SYNC	Power-down SYNC	Power-down distribution reference	Soft SYNC		00
231		Unused			Unused				00	
<b>Update All Registers</b>										
232	IO_UPDATE	Unused						IO_UPDATE (self-clearing)		00
233 to 9FF		Unused								00
<b>EEPROM Buffer Segment</b>										
A00	EEPROM Buffer Segment Register 1	0	EEPROM Buffer Segment Register 1 (default: number of bytes for Group 1)							00
A01	EEPROM Buffer Segment Register 2	EEPROM Buffer Segment Register 2 (default: Bits[15:8] of starting register address for Group 1)								00
A02	EEPROM Buffer Segment Register 3	EEPROM Buffer Segment Register 3 (default: Bits[7:0] of starting register address for Group 1)								00
A03	EEPROM Buffer Segment Register 4	0	EEPROM Buffer Segment Register 4 (default: number of bytes for Group 2)							02
A04	EEPROM Buffer Segment Register 5	EEPROM Buffer Segment Register 5 (default: Bits[15:8] of starting register address for Group 2)								00

# AD9522-4

Addr (Hex)	Parameter	Bit 7 (MSB)	Bit 6	Bit 5	Bit 4	Bit 3	Bit 2	Bit 1	Bit 0 (LSB)	Default Value (Hex)	
A05	EEPROM Buffer Segment Register 6	EEPROM Buffer Segment Register 6 (default: Bits[7:0] of starting register address for Group 2)								04	
A06	EEPROM Buffer Segment Register 7	0	EEPROM Buffer Segment Register 7 (default: number of bytes for Group 3)								0E
A07	EEPROM Buffer Segment Register 8	EEPROM Buffer Segment Register 8 (default: Bits[15:8] of starting register address for Group 3)								00	
A08	EEPROM Buffer Segment Register 9	EEPROM Buffer Segment Register 9 (default: Bits[7:0] of starting register address for Group 3)								10	
A09	EEPROM Buffer Segment Register 10	0	EEPROM Buffer Segment Register 10 (default: number of bytes for Group 4)								0E
A0A	EEPROM Buffer Segment Register 11	EEPROM Buffer Segment Register 11 (default: Bits[15:8] of starting register address for Group 4)								00	
A0B	EEPROM Buffer Segment Register 12	EEPROM Buffer Segment Register 12 (default: Bits[7:0] of starting register address for Group 4)								F0	
A0C	EEPROM Buffer Segment Register 13	0	EEPROM Buffer Segment Register 13 (default: number of bytes for Group 5)								0B
A0D	EEPROM Buffer Segment Register 14	EEPROM Buffer Segment Register 14 (default: Bits[15:8] of starting register address for Group 5)								01	
A0E	EEPROM Buffer Segment Register 15	EEPROM Buffer Segment Register 15 (default: Bits[7:0] of starting register address for Group 5)								90	
A0F	EEPROM Buffer Segment Register 16	0	EEPROM Buffer Segment Register 16 (default: number of bytes for Group 6)								01
A10	EEPROM Buffer Segment Register 17	EEPROM Buffer Segment Register 17 (default: Bits[15:8] of starting register address for Group 6)								01	
A11	EEPROM Buffer Segment Register 18	EEPROM Buffer Segment Register 18 (default: Bits[7:0] of starting register address for Group 6)								E0	
A12	EEPROM Buffer Segment Register 19	0	EEPROM Buffer Segment Register 19 (default: number of bytes for Group 7)								01
A13	EEPROM Buffer Segment Register 20	EEPROM Buffer Segment Register 20 (default: Bits[15:8] of starting register address for Group 7)								02	
A14	EEPROM Buffer Segment Register 21	EEPROM Buffer Segment Register 21 (default: Bits[7:0] of starting register address for Group 7)								30	
A15	EEPROM Buffer Segment Register 22	EEPROM Buffer Segment Register 22 (default: IO_UPDATE from EEPROM)								80	
A16	EEPROM Buffer Segment Register 23	EEPROM Buffer Segment Register 23 (default: end of data)								FF	
A17 to AFF		Unused								00	



Addr (Hex)	Parameter	Bit 7 (MSB)	Bit 6	Bit 5	Bit 4	Bit 3	Bit 2	Bit 1	Bit 0 (LSB)	Default Value (Hex)
<b>EEPROM Control</b>										
B00	EEPROM status (read-only)	Unused						Unused	STATUS_EEPROM	00
B01	EEPROM error checking (read-only)	Unused						Unused	EEPROM data error	00
B02	EEPROM Control 1	Unused						Soft_EEPROM (self-clearing)	Enable EEPROM write	00
B03	EEPROM Control 2	Unused						Unused	REG2EEPROM (self-clearing)	00

## REGISTER MAP DESCRIPTIONS

Table 49 through Table 59 provide a detailed description of each of the control register functions. The registers are listed by hexadecimal address. Reference to a specific bit or range of bits within a register is indicated by squared brackets. For example, [3] refers to Bit 3 and [5:2] refers to the range of bits from Bit 5 through Bit 2.

**Table 49. SPI Mode Serial Port Configuration**

Reg Addr (Hex)	Bit(s)	Name	Description
000	[7]	SDO active	Selects unidirectional or bidirectional data transfer mode. [7] = 0; SDIO pin used for write and read; SDO is high impedance (default). [7] = 1; SDO used for read; SDIO used for write; unidirectional mode.
000	[6]	LSB first/addr incr	SPI MSB or LSB data orientation. (This register is ignored in I <sup>2</sup> C mode.) [6] = 0; data-oriented MSB first; addressing decrements (default). [6] = 1; data-oriented LSB first; addressing increments.
000	[5]	Soft reset	Soft reset. [5] = 1 (self-clearing). Soft reset; restores default values to internal registers. This bit self clears on the next SCLK cycle after the completion of writing to this register.
000	[4]	Unused	
000	[3:0]	Mirror[7:4]	Bits[3:0] should always mirror Bits[7:4] so that it does not matter whether the part is in MSB or LSB first mode (see Register 0x000[6]). Set bits as follows: [0] = [7] [1] = [6] [2] = [5] [3] = [4]
004	[0]	Readback active registers	Select register bank used for a readback. [0] = 0; read back buffer registers (default). [0] = 1; read back active registers.

**Table 50. I<sup>2</sup>C Mode Serial Port Configuration**

Reg Addr (Hex)	Bit(s)	Name	Description
000	[7:6]	Unused	
000	[5]	Soft reset	Soft reset. [5] = 1 (self-clearing). Soft reset; restores default values to internal registers. This bit self clears on the next SCL cycle after the completion of writing to this register.
000	[4]	Unused	
000	[3:0]	Mirror[7:4]	Bits[3:0] should always mirror Bits[7:4] so that it does not matter whether the part is in MSB or LSB first mode (see Register 0x000[6]). Set bits as follows: [0] = [7] [1] = [6] [2] = [5] [3] = [4]
004	[0]	Readback active registers	Select register bank used for a readback. [0] = 0; read back buffer registers (default). [0] = 1; read back active registers.

**Table 51. EEPROM ID**

Reg Addr (Hex)	Bit(s)	Name	Description
005	[7:0]	EEPROM customer version ID (LSB)	16-bit EEPROM ID[7:0]. This register, along with 0x006, allows the user to store a unique ID to identify which version of the AD9522 register settings is stored in the EEPROM. It does not affect AD9522 operation in any way (default: 0x00).
006	[7:0]	EEPROM customer version ID (MSB)	16-bit EEPROM ID[15:8]. This register, along with 0x005, allows the user to store a unique ID to identify which version of the AD9522 register settings is stored in the EEPROM. It does not affect AD9522 operation in any way (default: 0x00).

Table 52. PLL

Reg. Addr (Hex)	Bit(s)	Name	Description																																				
010	[7]	PFD polarity	Sets the PFD polarity. Negative polarity is for use (if needed) with external VCO/VCXO only. The on-chip VCO requires positive polarity, [7] = 0. [7] = 0; positive (higher control voltage produces higher frequency) (default). [7] = 1; negative (higher control voltage produces lower frequency).																																				
010	[6:4]	CP current	Charge pump current (with CPRSET = 5.1 kΩ). <table border="1"> <thead> <tr> <th>[6]</th> <th>[5]</th> <th>[4]</th> <th>I<sub>CP</sub> (mA)</th> </tr> </thead> <tbody> <tr><td>0</td><td>0</td><td>0</td><td>0.6</td></tr> <tr><td>0</td><td>0</td><td>1</td><td>1.2</td></tr> <tr><td>0</td><td>1</td><td>0</td><td>1.8</td></tr> <tr><td>0</td><td>1</td><td>1</td><td>2.4</td></tr> <tr><td>1</td><td>0</td><td>0</td><td>3.0</td></tr> <tr><td>1</td><td>0</td><td>1</td><td>3.6</td></tr> <tr><td>1</td><td>1</td><td>0</td><td>4.2</td></tr> <tr><td>1</td><td>1</td><td>1</td><td>4.8 (default)</td></tr> </tbody> </table>	[6]	[5]	[4]	I <sub>CP</sub> (mA)	0	0	0	0.6	0	0	1	1.2	0	1	0	1.8	0	1	1	2.4	1	0	0	3.0	1	0	1	3.6	1	1	0	4.2	1	1	1	4.8 (default)
[6]	[5]	[4]	I <sub>CP</sub> (mA)																																				
0	0	0	0.6																																				
0	0	1	1.2																																				
0	1	0	1.8																																				
0	1	1	2.4																																				
1	0	0	3.0																																				
1	0	1	3.6																																				
1	1	0	4.2																																				
1	1	1	4.8 (default)																																				
010	[3:2]	CP mode	Charge pump operating mode. <table border="1"> <thead> <tr> <th>[3]</th> <th>[2]</th> <th>Charge Pump Mode</th> </tr> </thead> <tbody> <tr><td>0</td><td>0</td><td>High impedance state.</td></tr> <tr><td>0</td><td>1</td><td>Force source current (pump up).</td></tr> <tr><td>1</td><td>0</td><td>Force sink current (pump down).</td></tr> <tr><td>1</td><td>1</td><td>Normal operation (default).</td></tr> </tbody> </table>	[3]	[2]	Charge Pump Mode	0	0	High impedance state.	0	1	Force source current (pump up).	1	0	Force sink current (pump down).	1	1	Normal operation (default).																					
[3]	[2]	Charge Pump Mode																																					
0	0	High impedance state.																																					
0	1	Force source current (pump up).																																					
1	0	Force sink current (pump down).																																					
1	1	Normal operation (default).																																					
010	[1:0]	PLL power-down	PLL operating mode. <table border="1"> <thead> <tr> <th>[1]</th> <th>[0]</th> <th>Mode</th> </tr> </thead> <tbody> <tr><td>0</td><td>0</td><td>Normal operation; this mode must be selected to use the PLL.</td></tr> <tr><td>0</td><td>1</td><td>Asynchronous power-down (default).</td></tr> <tr><td>1</td><td>0</td><td>Unused.</td></tr> <tr><td>1</td><td>1</td><td>Synchronous power-down.</td></tr> </tbody> </table>	[1]	[0]	Mode	0	0	Normal operation; this mode must be selected to use the PLL.	0	1	Asynchronous power-down (default).	1	0	Unused.	1	1	Synchronous power-down.																					
[1]	[0]	Mode																																					
0	0	Normal operation; this mode must be selected to use the PLL.																																					
0	1	Asynchronous power-down (default).																																					
1	0	Unused.																																					
1	1	Synchronous power-down.																																					
011	[7:0]	14-bit R counter, Bits[7:0] (LSB)	Reference divider LSBs—lower eight bits. The reference divider (also called the R divider or R counter) is 14 bits long. The lower eight bits are in this register (default: 0x01).																																				
012	[5:0]	14-bit R counter, Bits[13:8] (MSB)	Reference divider MSBs—upper six bits. The reference divider (also called the R divider or R counter) is 14 bits long. The upper six bits are in this register (default: 0x00).																																				
013	[5:0]	6-bit A counter	A counter (part of N divider). The N divider is also called the feedback divider (default: 0x00).																																				
014	[7:0]	13-bit B counter, Bits[7:0] (LSB)	B counter (part of N divider)—lower eight bits. The N divider is also called the feedback divider (default: 0x03).																																				
015	[4:0]	13-bit B counter, Bits[12:8] (MSB)	B counter (part of N divider)—upper five bits. The N divider is also called the feedback divider (default: 0x00).																																				
016	[7]	Set CP pin to VCP/2	Sets the CP pin to one-half of the VCP supply voltage. [7] = 0; CP normal operation (default). [7] = 1; CP pin set to VCP/2.																																				
016	[6]	Reset R counter	Reset R counter (R divider). [6] = 0; normal (default). [6] = 1; hold R counter in reset.																																				
016	[5]	Reset A and B counters	Reset A and B counters (part of N divider). [5] = 0; normal (default). [5] = 1; hold A and B counters in reset.																																				
016	[4]	Reset all counters	Reset R, A, and B counters. [4] = 0; normal (default). [4] = 1; hold R, A, and B counters in reset.																																				

# AD9522-4

Reg. Addr (Hex)	Bit(s)	Name	Description																																																																																																																																																																																																																																								
016	[3]	B counter bypass	B counter bypass. This is only valid when operating the prescaler in FD mode. [3] = 0; normal (default). [3] = 1; B counter is set to divide-by-1. This allows the prescaler setting to determine the divide for the N divider.																																																																																																																																																																																																																																								
016	[2:0]	Prescaler P	Prescaler: DM = dual modulus and FD = fixed divide. The Prescaler P is part of the feedback divider. <table border="1"> <thead> <tr> <th>[2]</th> <th>[1]</th> <th>[0]</th> <th>Mode</th> <th>Prescaler</th> </tr> </thead> <tbody> <tr> <td>0</td> <td>0</td> <td>0</td> <td>FD</td> <td>Divide-by-1.</td> </tr> <tr> <td>0</td> <td>0</td> <td>1</td> <td>FD</td> <td>Divide-by-2.</td> </tr> <tr> <td>0</td> <td>1</td> <td>0</td> <td>DM</td> <td>Divide-by-2 and divide-by-3 when A ≠ 0; divide-by-2 when A = 0.</td> </tr> <tr> <td>0</td> <td>1</td> <td>1</td> <td>DM</td> <td>Divide-by-4 and divide-by-5 when A ≠ 0; divide-by-4 when A = 0.</td> </tr> <tr> <td>1</td> <td>0</td> <td>0</td> <td>DM</td> <td>Divide-by-8 and divide-by-9 when A ≠ 0; divide-by-8 when A = 0.</td> </tr> <tr> <td>1</td> <td>0</td> <td>1</td> <td>DM</td> <td>Divide-by-16 and divide-by-17 when A ≠ 0; divide-by-16 when A = 0.</td> </tr> <tr> <td>1</td> <td>1</td> <td>0</td> <td>DM</td> <td>Divide-by-32 and divide-by-33 when A ≠ 0; divide-by-32 when A = 0 (default).</td> </tr> <tr> <td>1</td> <td>1</td> <td>1</td> <td>FD</td> <td>Divide-by-3.</td> </tr> </tbody> </table>	[2]	[1]	[0]	Mode	Prescaler	0	0	0	FD	Divide-by-1.	0	0	1	FD	Divide-by-2.	0	1	0	DM	Divide-by-2 and divide-by-3 when A ≠ 0; divide-by-2 when A = 0.	0	1	1	DM	Divide-by-4 and divide-by-5 when A ≠ 0; divide-by-4 when A = 0.	1	0	0	DM	Divide-by-8 and divide-by-9 when A ≠ 0; divide-by-8 when A = 0.	1	0	1	DM	Divide-by-16 and divide-by-17 when A ≠ 0; divide-by-16 when A = 0.	1	1	0	DM	Divide-by-32 and divide-by-33 when A ≠ 0; divide-by-32 when A = 0 (default).	1	1	1	FD	Divide-by-3.																																																																																																																																																																																											
[2]	[1]	[0]	Mode	Prescaler																																																																																																																																																																																																																																							
0	0	0	FD	Divide-by-1.																																																																																																																																																																																																																																							
0	0	1	FD	Divide-by-2.																																																																																																																																																																																																																																							
0	1	0	DM	Divide-by-2 and divide-by-3 when A ≠ 0; divide-by-2 when A = 0.																																																																																																																																																																																																																																							
0	1	1	DM	Divide-by-4 and divide-by-5 when A ≠ 0; divide-by-4 when A = 0.																																																																																																																																																																																																																																							
1	0	0	DM	Divide-by-8 and divide-by-9 when A ≠ 0; divide-by-8 when A = 0.																																																																																																																																																																																																																																							
1	0	1	DM	Divide-by-16 and divide-by-17 when A ≠ 0; divide-by-16 when A = 0.																																																																																																																																																																																																																																							
1	1	0	DM	Divide-by-32 and divide-by-33 when A ≠ 0; divide-by-32 when A = 0 (default).																																																																																																																																																																																																																																							
1	1	1	FD	Divide-by-3.																																																																																																																																																																																																																																							
017	[7:2]	STATUS pin control	Selects the signal that appears at the STATUS pin. 0x01D[7] must be 0 to reprogram the STATUS pin. <table border="1"> <thead> <tr> <th>[7]</th> <th>[6]</th> <th>[5]</th> <th>[4]</th> <th>[3]</th> <th>[2]</th> <th>Level or Dynamic Signal</th> <th>Signal at STATUS Pin</th> </tr> </thead> <tbody> <tr> <td>0</td> <td>0</td> <td>0</td> <td>0</td> <td>0</td> <td>0</td> <td>LVL</td> <td>Ground, dc (default).</td> </tr> <tr> <td>0</td> <td>0</td> <td>0</td> <td>0</td> <td>0</td> <td>1</td> <td>DYN</td> <td>N divider output (after the delay).</td> </tr> <tr> <td>0</td> <td>0</td> <td>0</td> <td>0</td> <td>1</td> <td>0</td> <td>DYN</td> <td>R divider output (after the delay).</td> </tr> <tr> <td>0</td> <td>0</td> <td>0</td> <td>0</td> <td>1</td> <td>1</td> <td>DYN</td> <td>A divider output.</td> </tr> <tr> <td>0</td> <td>0</td> <td>0</td> <td>1</td> <td>0</td> <td>0</td> <td>DYN</td> <td>Prescaler output.</td> </tr> <tr> <td>0</td> <td>0</td> <td>0</td> <td>1</td> <td>0</td> <td>1</td> <td>DYN</td> <td>PFD up pulse.</td> </tr> <tr> <td>0</td> <td>0</td> <td>0</td> <td>1</td> <td>1</td> <td>0</td> <td>DYN</td> <td>PFD down pulse.</td> </tr> <tr> <td>0</td> <td>X</td> <td>X</td> <td>X</td> <td>X</td> <td>X</td> <td>LVL</td> <td>Ground (dc); for all other cases of 0XXXXX not specified. The selections that follow are the same as for REFMON.</td> </tr> <tr> <td>1</td> <td>0</td> <td>0</td> <td>0</td> <td>0</td> <td>0</td> <td>LVL</td> <td>Ground (dc).</td> </tr> <tr> <td>1</td> <td>0</td> <td>0</td> <td>0</td> <td>0</td> <td>1</td> <td>DYN</td> <td>REF1 clock (differential reference when in differential mode).</td> </tr> <tr> <td>1</td> <td>0</td> <td>0</td> <td>0</td> <td>1</td> <td>0</td> <td>DYN</td> <td>REF2 clock (N/A in differential mode).</td> </tr> <tr> <td>1</td> <td>0</td> <td>0</td> <td>0</td> <td>1</td> <td>1</td> <td>DYN</td> <td>Selected reference to PLL (differential reference when in differential mode).</td> </tr> <tr> <td>1</td> <td>0</td> <td>0</td> <td>1</td> <td>0</td> <td>0</td> <td>DYN</td> <td>Unselected reference to PLL (not available in differential mode).</td> </tr> <tr> <td>1</td> <td>0</td> <td>0</td> <td>1</td> <td>0</td> <td>1</td> <td>LVL</td> <td>Status of selected reference (status of differential reference); active high.</td> </tr> <tr> <td>1</td> <td>0</td> <td>0</td> <td>1</td> <td>1</td> <td>0</td> <td>LVL</td> <td>Status of unselected reference (not available in differential mode); active high.</td> </tr> <tr> <td>1</td> <td>0</td> <td>0</td> <td>1</td> <td>1</td> <td>1</td> <td>LVL</td> <td>Status REF1 frequency (active high).</td> </tr> <tr> <td>1</td> <td>0</td> <td>1</td> <td>0</td> <td>0</td> <td>0</td> <td>LVL</td> <td>Status REF2 frequency (active high).</td> </tr> <tr> <td>1</td> <td>0</td> <td>1</td> <td>0</td> <td>0</td> <td>1</td> <td>LVL</td> <td>(Status REF1 frequency) AND (status REF2 frequency).</td> </tr> <tr> <td>1</td> <td>0</td> <td>1</td> <td>0</td> <td>1</td> <td>0</td> <td>LVL</td> <td>(DLD) AND (status of selected reference) AND (status of VCO).</td> </tr> <tr> <td>1</td> <td>0</td> <td>1</td> <td>0</td> <td>1</td> <td>1</td> <td>LVL</td> <td>Status of VCO frequency (active high).</td> </tr> <tr> <td>1</td> <td>0</td> <td>1</td> <td>1</td> <td>0</td> <td>0</td> <td>LVL</td> <td>Selected reference (low = REF1, high = REF2).</td> </tr> <tr> <td>1</td> <td>0</td> <td>1</td> <td>1</td> <td>0</td> <td>1</td> <td>LVL</td> <td>DLD; active high.</td> </tr> <tr> <td>1</td> <td>0</td> <td>1</td> <td>1</td> <td>1</td> <td>0</td> <td>LVL</td> <td>Holdover active (active high).</td> </tr> <tr> <td>1</td> <td>0</td> <td>1</td> <td>1</td> <td>1</td> <td>1</td> <td>LVL</td> <td>LD pin comparator output (active high).</td> </tr> <tr> <td>1</td> <td>1</td> <td>0</td> <td>0</td> <td>0</td> <td>0</td> <td>LVL</td> <td>VS (PLL power supply).</td> </tr> <tr> <td>1</td> <td>1</td> <td>0</td> <td>0</td> <td>0</td> <td>1</td> <td>DYN</td> <td>REF1 clock (differential reference when in differential mode).</td> </tr> <tr> <td>1</td> <td>1</td> <td>0</td> <td>0</td> <td>1</td> <td>0</td> <td>DYN</td> <td>REF2 clock (not available in differential mode).</td> </tr> <tr> <td>1</td> <td>1</td> <td>0</td> <td>0</td> <td>1</td> <td>1</td> <td>DYN</td> <td>Selected reference to PLL (differential reference when in differential mode).</td> </tr> </tbody> </table>	[7]	[6]	[5]	[4]	[3]	[2]	Level or Dynamic Signal	Signal at STATUS Pin	0	0	0	0	0	0	LVL	Ground, dc (default).	0	0	0	0	0	1	DYN	N divider output (after the delay).	0	0	0	0	1	0	DYN	R divider output (after the delay).	0	0	0	0	1	1	DYN	A divider output.	0	0	0	1	0	0	DYN	Prescaler output.	0	0	0	1	0	1	DYN	PFD up pulse.	0	0	0	1	1	0	DYN	PFD down pulse.	0	X	X	X	X	X	LVL	Ground (dc); for all other cases of 0XXXXX not specified. The selections that follow are the same as for REFMON.	1	0	0	0	0	0	LVL	Ground (dc).	1	0	0	0	0	1	DYN	REF1 clock (differential reference when in differential mode).	1	0	0	0	1	0	DYN	REF2 clock (N/A in differential mode).	1	0	0	0	1	1	DYN	Selected reference to PLL (differential reference when in differential mode).	1	0	0	1	0	0	DYN	Unselected reference to PLL (not available in differential mode).	1	0	0	1	0	1	LVL	Status of selected reference (status of differential reference); active high.	1	0	0	1	1	0	LVL	Status of unselected reference (not available in differential mode); active high.	1	0	0	1	1	1	LVL	Status REF1 frequency (active high).	1	0	1	0	0	0	LVL	Status REF2 frequency (active high).	1	0	1	0	0	1	LVL	(Status REF1 frequency) AND (status REF2 frequency).	1	0	1	0	1	0	LVL	(DLD) AND (status of selected reference) AND (status of VCO).	1	0	1	0	1	1	LVL	Status of VCO frequency (active high).	1	0	1	1	0	0	LVL	Selected reference (low = REF1, high = REF2).	1	0	1	1	0	1	LVL	DLD; active high.	1	0	1	1	1	0	LVL	Holdover active (active high).	1	0	1	1	1	1	LVL	LD pin comparator output (active high).	1	1	0	0	0	0	LVL	VS (PLL power supply).	1	1	0	0	0	1	DYN	REF1 clock (differential reference when in differential mode).	1	1	0	0	1	0	DYN	REF2 clock (not available in differential mode).	1	1	0	0	1	1	DYN	Selected reference to PLL (differential reference when in differential mode).
[7]	[6]	[5]	[4]	[3]	[2]	Level or Dynamic Signal	Signal at STATUS Pin																																																																																																																																																																																																																																				
0	0	0	0	0	0	LVL	Ground, dc (default).																																																																																																																																																																																																																																				
0	0	0	0	0	1	DYN	N divider output (after the delay).																																																																																																																																																																																																																																				
0	0	0	0	1	0	DYN	R divider output (after the delay).																																																																																																																																																																																																																																				
0	0	0	0	1	1	DYN	A divider output.																																																																																																																																																																																																																																				
0	0	0	1	0	0	DYN	Prescaler output.																																																																																																																																																																																																																																				
0	0	0	1	0	1	DYN	PFD up pulse.																																																																																																																																																																																																																																				
0	0	0	1	1	0	DYN	PFD down pulse.																																																																																																																																																																																																																																				
0	X	X	X	X	X	LVL	Ground (dc); for all other cases of 0XXXXX not specified. The selections that follow are the same as for REFMON.																																																																																																																																																																																																																																				
1	0	0	0	0	0	LVL	Ground (dc).																																																																																																																																																																																																																																				
1	0	0	0	0	1	DYN	REF1 clock (differential reference when in differential mode).																																																																																																																																																																																																																																				
1	0	0	0	1	0	DYN	REF2 clock (N/A in differential mode).																																																																																																																																																																																																																																				
1	0	0	0	1	1	DYN	Selected reference to PLL (differential reference when in differential mode).																																																																																																																																																																																																																																				
1	0	0	1	0	0	DYN	Unselected reference to PLL (not available in differential mode).																																																																																																																																																																																																																																				
1	0	0	1	0	1	LVL	Status of selected reference (status of differential reference); active high.																																																																																																																																																																																																																																				
1	0	0	1	1	0	LVL	Status of unselected reference (not available in differential mode); active high.																																																																																																																																																																																																																																				
1	0	0	1	1	1	LVL	Status REF1 frequency (active high).																																																																																																																																																																																																																																				
1	0	1	0	0	0	LVL	Status REF2 frequency (active high).																																																																																																																																																																																																																																				
1	0	1	0	0	1	LVL	(Status REF1 frequency) AND (status REF2 frequency).																																																																																																																																																																																																																																				
1	0	1	0	1	0	LVL	(DLD) AND (status of selected reference) AND (status of VCO).																																																																																																																																																																																																																																				
1	0	1	0	1	1	LVL	Status of VCO frequency (active high).																																																																																																																																																																																																																																				
1	0	1	1	0	0	LVL	Selected reference (low = REF1, high = REF2).																																																																																																																																																																																																																																				
1	0	1	1	0	1	LVL	DLD; active high.																																																																																																																																																																																																																																				
1	0	1	1	1	0	LVL	Holdover active (active high).																																																																																																																																																																																																																																				
1	0	1	1	1	1	LVL	LD pin comparator output (active high).																																																																																																																																																																																																																																				
1	1	0	0	0	0	LVL	VS (PLL power supply).																																																																																																																																																																																																																																				
1	1	0	0	0	1	DYN	REF1 clock (differential reference when in differential mode).																																																																																																																																																																																																																																				
1	1	0	0	1	0	DYN	REF2 clock (not available in differential mode).																																																																																																																																																																																																																																				
1	1	0	0	1	1	DYN	Selected reference to PLL (differential reference when in differential mode).																																																																																																																																																																																																																																				

Reg. Addr (Hex)	Bit(s)	Name	Description						Level or Dynamic Signal	Signal at STATUS Pin
			[7]	[6]	[5]	[4]	[3]	[2]		
			1	1	0	1	0	0	DYN	Unselected reference to PLL (not available when in differential mode).
			1	1	0	1	0	1	LVL	Status of selected reference (status of differential reference); active low.
			1	1	0	1	1	0	LVL	Status of unselected reference (not available in differential mode); active low.
			1	1	0	1	1	1	LVL	Status of REF1 frequency (active low).
			1	1	1	0	0	0	LVL	Status of REF2 frequency (active low).
			1	1	1	0	0	1	LVL	(Status of REF1 frequency) AND (status of REF2 frequency).
			1	1	1	0	1	0	LVL	(DLD) AND (Status of selected reference) AND (status of VCO).
			1	1	1	0	1	1	LVL	Status of VCO frequency (active low).
			1	1	1	1	0	0	LVL	Selected reference (low = REF2, high = REF1).
			1	1	1	1	0	1	LVL	DLD (active low).
			1	1	1	1	1	0	LVL	Holdover active (active low).
			1	1	1	1	1	1	LVL	LD pin comparator output (active low).
017	[1:0]	Antibacklash pulse width	[1]	[0]	<b>Antibacklash Pulse Width (ns)</b>					
			0	0	2.9 (default)					
			0	1	1.3					
			1	0	6.0					
			1	1	2.9					
018	[7]	Enable CMOS reference input dc offset	Enables dc offset in single-ended CMOS input mode to prevent chattering when ac-coupled and input is lost. [7] = 0; disable dc offset (default). [7] = 1; enable dc offset.							
018	[6:5]	Lock detect counter	Required consecutive number of PFD cycles with edges inside lock detect window before the DLD indicates a locked condition.							
			[6]	[5]	<b>PFD Cycles to Determine Lock</b>					
			0	0	5 (default)					
			0	1	16					
			1	0	64					
			1	1	255					
018	[4]	Digital lock detect window	If the time difference of the rising edges at the inputs to the PFD are less than the lock detect window time, the digital lock detect flag is set. The flag remains set until the time difference is greater than the loss-of-lock threshold. [4] = 0; high range (default). [4] = 1; low range.							
018	[3]	Disable digital lock detect	Digital lock detect operation. [3] = 0; normal lock detect operation (default). [3] = 1; disable lock detect.							
018	[2:1]	VCO calibration divider	Divider used to generate the VCO calibration clock from the PLL reference clock (see the VCO Calibration section for the recommended setting of the VCO calibration divider based on the PFD rate).							
			[2]	[1]	<b>VCO Calibration Clock Divider</b>					
			0	0	2					
			0	1	4					
			1	0	8					
			1	1	16 (default)					

# AD9522-4

Reg. Addr (Hex)	Bit(s)	Name	Description																																																																																																																																																																																																								
018	[0]	VCO calibration now	Bit used to initiate the VCO calibration. This bit must be toggled from 0 to 1 in the active registers. The sequence to initiate a calibration follows: program to 0, followed by an IO_UPDATE bit (Register 0x232[0]); then program to 1, followed by another IO_UPDATE bit (Register 0x232[0]). This sequence gives complete control over when the VCO calibration occurs relative to the programming of other registers that can impact the calibration (default = 0). Note that the VCO divider (Register 0x1E0[2:0]) must not be static during VCO calibration.																																																																																																																																																																																																								
019	[7:6]	R, A, B counters SYNC pin reset	<table border="1"> <thead> <tr> <th>[7]</th> <th>[6]</th> <th>Action</th> </tr> </thead> <tbody> <tr> <td>0</td> <td>0</td> <td>Do nothing on <math>\overline{\text{SYNC}}</math> (default).</td> </tr> <tr> <td>0</td> <td>1</td> <td>Asynchronous reset.</td> </tr> <tr> <td>1</td> <td>0</td> <td>Synchronous reset.</td> </tr> <tr> <td>1</td> <td>1</td> <td>Do nothing on <math>\overline{\text{SYNC}}</math>.</td> </tr> </tbody> </table>	[7]	[6]	Action	0	0	Do nothing on $\overline{\text{SYNC}}$ (default).	0	1	Asynchronous reset.	1	0	Synchronous reset.	1	1	Do nothing on $\overline{\text{SYNC}}$ .																																																																																																																																																																																									
[7]	[6]	Action																																																																																																																																																																																																									
0	0	Do nothing on $\overline{\text{SYNC}}$ (default).																																																																																																																																																																																																									
0	1	Asynchronous reset.																																																																																																																																																																																																									
1	0	Synchronous reset.																																																																																																																																																																																																									
1	1	Do nothing on $\overline{\text{SYNC}}$ .																																																																																																																																																																																																									
019	[5:3]	R path delay	R path delay, see Table 2 (default: 0x0).																																																																																																																																																																																																								
019	[2:0]	N path delay	N path delay, see Table 2 (default: 0x0).																																																																																																																																																																																																								
01A	[7]	Enable STATUS pin divider	Enables a divide-by-4 on the STATUS pin. This makes it easier to look at low duty-cycle signals out of the R and N dividers. [7] = 0; divide-by-4 disabled on STATUS pin (default). [7] = 1; divide-by-4 enabled on STATUS pin.																																																																																																																																																																																																								
01A	[6]	Ref freq monitor threshold	Sets the reference (REF1/REF2) frequency monitor's detection threshold frequency. This does not affect the VCO frequency monitor's detection threshold (see Table 17, REF1, REF2, and VCO frequency status monitor parameter). [6] = 0; frequency valid if frequency is above 1.02 MHz (default). [6] = 1; frequency valid if frequency is above 6 kHz.																																																																																																																																																																																																								
01A	[5:0]	LD pin control	<p>Selects the signal that is connected to the LD pin.</p> <table border="1"> <thead> <tr> <th>[5]</th> <th>[4]</th> <th>[3]</th> <th>[2]</th> <th>[1]</th> <th>[0]</th> <th>Level or Dynamic Signal</th> <th>Signal at LD Pin</th> </tr> </thead> <tbody> <tr> <td>0</td> <td>0</td> <td>0</td> <td>0</td> <td>0</td> <td>0</td> <td>LVL</td> <td>Digital lock detect (high = lock; low = unlock, default).</td> </tr> <tr> <td>0</td> <td>0</td> <td>0</td> <td>0</td> <td>0</td> <td>1</td> <td>DYN</td> <td>P-channel, open-drain lock detect (analog lock detect).</td> </tr> <tr> <td>0</td> <td>0</td> <td>0</td> <td>0</td> <td>1</td> <td>0</td> <td>DYN</td> <td>N-channel, open-drain lock detect (analog lock detect).</td> </tr> <tr> <td>0</td> <td>0</td> <td>0</td> <td>0</td> <td>1</td> <td>1</td> <td>HIZ</td> <td>Tristate (high-Z) LD pin.</td> </tr> <tr> <td>0</td> <td>0</td> <td>0</td> <td>1</td> <td>0</td> <td>0</td> <td>CUR</td> <td>Current source lock detect (110 <math>\mu</math>A when DLD is true).</td> </tr> <tr> <td>0</td> <td>X</td> <td>X</td> <td>X</td> <td>X</td> <td>X</td> <td>LVL</td> <td>Ground (dc); for all other cases of 0XXXXX not specified. The selections that follow are the same as for REFMON.</td> </tr> <tr> <td>1</td> <td>0</td> <td>0</td> <td>0</td> <td>0</td> <td>0</td> <td>LVL</td> <td>Ground (dc).</td> </tr> <tr> <td>1</td> <td>0</td> <td>0</td> <td>0</td> <td>0</td> <td>1</td> <td>DYN</td> <td>REF1 clock (differential reference when in differential mode).</td> </tr> <tr> <td>1</td> <td>0</td> <td>0</td> <td>0</td> <td>1</td> <td>0</td> <td>DYN</td> <td>REF2 clock (N/A in differential mode).</td> </tr> <tr> <td>1</td> <td>0</td> <td>0</td> <td>0</td> <td>1</td> <td>1</td> <td>DYN</td> <td>Selected reference to PLL (differential reference when in differential mode).</td> </tr> <tr> <td>1</td> <td>0</td> <td>0</td> <td>1</td> <td>0</td> <td>0</td> <td>DYN</td> <td>Unselected reference to PLL (not available in differential mode).</td> </tr> <tr> <td>1</td> <td>0</td> <td>0</td> <td>1</td> <td>0</td> <td>1</td> <td>LVL</td> <td>Status of selected reference (status of differential reference); active high.</td> </tr> <tr> <td>1</td> <td>0</td> <td>0</td> <td>1</td> <td>1</td> <td>0</td> <td>LVL</td> <td>Status of unselected reference (not available in differential mode); active high.</td> </tr> <tr> <td>1</td> <td>0</td> <td>0</td> <td>1</td> <td>1</td> <td>1</td> <td>LVL</td> <td>Status REF1 frequency (active high).</td> </tr> <tr> <td>1</td> <td>0</td> <td>1</td> <td>0</td> <td>0</td> <td>0</td> <td>LVL</td> <td>Status REF2 frequency (active high).</td> </tr> <tr> <td>1</td> <td>0</td> <td>1</td> <td>0</td> <td>0</td> <td>1</td> <td>LVL</td> <td>(Status REF1 frequency) AND (status REF2 frequency).</td> </tr> <tr> <td>1</td> <td>0</td> <td>1</td> <td>0</td> <td>1</td> <td>0</td> <td>LVL</td> <td>(DLD) AND (status of selected reference) AND (status of VCO).</td> </tr> <tr> <td>1</td> <td>0</td> <td>1</td> <td>0</td> <td>1</td> <td>1</td> <td>LVL</td> <td>Status of VCO frequency (active high).</td> </tr> <tr> <td>1</td> <td>0</td> <td>1</td> <td>1</td> <td>0</td> <td>0</td> <td>LVL</td> <td>Selected reference (low = REF1, high = REF2).</td> </tr> <tr> <td>1</td> <td>0</td> <td>1</td> <td>1</td> <td>0</td> <td>1</td> <td>LVL</td> <td>DLD; active high.</td> </tr> <tr> <td>1</td> <td>0</td> <td>1</td> <td>1</td> <td>1</td> <td>0</td> <td>LVL</td> <td>Holdover active (active high).</td> </tr> <tr> <td>1</td> <td>0</td> <td>1</td> <td>1</td> <td>1</td> <td>1</td> <td>LVL</td> <td>N/A, do not use.</td> </tr> <tr> <td>1</td> <td>1</td> <td>0</td> <td>0</td> <td>0</td> <td>0</td> <td>LVL</td> <td>VS (PLL supply).</td> </tr> <tr> <td>1</td> <td>1</td> <td>0</td> <td>0</td> <td>0</td> <td>1</td> <td>DYN</td> <td>REF1 clock (differential reference when in differential mode).</td> </tr> </tbody> </table>	[5]	[4]	[3]	[2]	[1]	[0]	Level or Dynamic Signal	Signal at LD Pin	0	0	0	0	0	0	LVL	Digital lock detect (high = lock; low = unlock, default).	0	0	0	0	0	1	DYN	P-channel, open-drain lock detect (analog lock detect).	0	0	0	0	1	0	DYN	N-channel, open-drain lock detect (analog lock detect).	0	0	0	0	1	1	HIZ	Tristate (high-Z) LD pin.	0	0	0	1	0	0	CUR	Current source lock detect (110 $\mu$ A when DLD is true).	0	X	X	X	X	X	LVL	Ground (dc); for all other cases of 0XXXXX not specified. The selections that follow are the same as for REFMON.	1	0	0	0	0	0	LVL	Ground (dc).	1	0	0	0	0	1	DYN	REF1 clock (differential reference when in differential mode).	1	0	0	0	1	0	DYN	REF2 clock (N/A in differential mode).	1	0	0	0	1	1	DYN	Selected reference to PLL (differential reference when in differential mode).	1	0	0	1	0	0	DYN	Unselected reference to PLL (not available in differential mode).	1	0	0	1	0	1	LVL	Status of selected reference (status of differential reference); active high.	1	0	0	1	1	0	LVL	Status of unselected reference (not available in differential mode); active high.	1	0	0	1	1	1	LVL	Status REF1 frequency (active high).	1	0	1	0	0	0	LVL	Status REF2 frequency (active high).	1	0	1	0	0	1	LVL	(Status REF1 frequency) AND (status REF2 frequency).	1	0	1	0	1	0	LVL	(DLD) AND (status of selected reference) AND (status of VCO).	1	0	1	0	1	1	LVL	Status of VCO frequency (active high).	1	0	1	1	0	0	LVL	Selected reference (low = REF1, high = REF2).	1	0	1	1	0	1	LVL	DLD; active high.	1	0	1	1	1	0	LVL	Holdover active (active high).	1	0	1	1	1	1	LVL	N/A, do not use.	1	1	0	0	0	0	LVL	VS (PLL supply).	1	1	0	0	0	1	DYN	REF1 clock (differential reference when in differential mode).
[5]	[4]	[3]	[2]	[1]	[0]	Level or Dynamic Signal	Signal at LD Pin																																																																																																																																																																																																				
0	0	0	0	0	0	LVL	Digital lock detect (high = lock; low = unlock, default).																																																																																																																																																																																																				
0	0	0	0	0	1	DYN	P-channel, open-drain lock detect (analog lock detect).																																																																																																																																																																																																				
0	0	0	0	1	0	DYN	N-channel, open-drain lock detect (analog lock detect).																																																																																																																																																																																																				
0	0	0	0	1	1	HIZ	Tristate (high-Z) LD pin.																																																																																																																																																																																																				
0	0	0	1	0	0	CUR	Current source lock detect (110 $\mu$ A when DLD is true).																																																																																																																																																																																																				
0	X	X	X	X	X	LVL	Ground (dc); for all other cases of 0XXXXX not specified. The selections that follow are the same as for REFMON.																																																																																																																																																																																																				
1	0	0	0	0	0	LVL	Ground (dc).																																																																																																																																																																																																				
1	0	0	0	0	1	DYN	REF1 clock (differential reference when in differential mode).																																																																																																																																																																																																				
1	0	0	0	1	0	DYN	REF2 clock (N/A in differential mode).																																																																																																																																																																																																				
1	0	0	0	1	1	DYN	Selected reference to PLL (differential reference when in differential mode).																																																																																																																																																																																																				
1	0	0	1	0	0	DYN	Unselected reference to PLL (not available in differential mode).																																																																																																																																																																																																				
1	0	0	1	0	1	LVL	Status of selected reference (status of differential reference); active high.																																																																																																																																																																																																				
1	0	0	1	1	0	LVL	Status of unselected reference (not available in differential mode); active high.																																																																																																																																																																																																				
1	0	0	1	1	1	LVL	Status REF1 frequency (active high).																																																																																																																																																																																																				
1	0	1	0	0	0	LVL	Status REF2 frequency (active high).																																																																																																																																																																																																				
1	0	1	0	0	1	LVL	(Status REF1 frequency) AND (status REF2 frequency).																																																																																																																																																																																																				
1	0	1	0	1	0	LVL	(DLD) AND (status of selected reference) AND (status of VCO).																																																																																																																																																																																																				
1	0	1	0	1	1	LVL	Status of VCO frequency (active high).																																																																																																																																																																																																				
1	0	1	1	0	0	LVL	Selected reference (low = REF1, high = REF2).																																																																																																																																																																																																				
1	0	1	1	0	1	LVL	DLD; active high.																																																																																																																																																																																																				
1	0	1	1	1	0	LVL	Holdover active (active high).																																																																																																																																																																																																				
1	0	1	1	1	1	LVL	N/A, do not use.																																																																																																																																																																																																				
1	1	0	0	0	0	LVL	VS (PLL supply).																																																																																																																																																																																																				
1	1	0	0	0	1	DYN	REF1 clock (differential reference when in differential mode).																																																																																																																																																																																																				

Reg. Addr (Hex)	Bit(s)	Name	Description						Level or Dynamic Signal	Signal at LD Pin	
			[5]	[4]	[3]	[2]	[1]	[0]			
			1	1	0	0	1	0	DYN	REF2 clock (not available in differential mode).	
			1	1	0	0	1	1	DYN	Selected reference to PLL (differential reference when in differential mode).	
			1	1	0	1	0	0	DYN	Unselected reference to PLL (not available when in differential mode).	
			1	1	0	1	0	1	LVL	Status of selected reference (status of differential reference); active low.	
			1	1	0	1	1	0	LVL	Status of unselected reference (not available in differential mode); active low.	
			1	1	0	1	1	1	LVL	Status of REF1 frequency (active low).	
			1	1	1	0	0	0	LVL	Status of REF2 frequency (active low).	
			1	1	1	0	0	1	LVL	(Status of REF1 frequency) AND (status of REF2 frequency).	
			1	1	1	0	1	0	LVL	(DLD) AND (Status of selected reference) AND (status of VCO).	
			1	1	1	0	1	1	LVL	Status of VCO frequency (active low).	
			1	1	1	1	0	0	LVL	Selected reference (low = REF2, high = REF1).	
			1	1	1	1	0	1	LVL	DLD; active low.	
			1	1	1	1	1	0	LVL	Holdover active (active low).	
			1	1	1	1	1	1	LVL	N/A, do not use.	
01B	[7]	Enable VCO frequency monitor	Enables or disables the VCO frequency monitor. [7] = 0; disable the VCO frequency monitor (default). [7] = 1; enable the VCO frequency monitor.								
01B	[6]	Enable REF2 (REFIN) frequency monitor	Enables or disables the REF2 frequency monitor. [6] = 0; disable the REF2 frequency monitor (default). [6] = 1; enable the REF2 frequency monitor.								
01B	[5]	Enable REF1 (REFIN) frequency monitor	REF1 (REFIN) frequency monitor enabled; this is for both REF1 (single-ended) and REFIN (differential) inputs (as selected by differential reference mode). [5] = 0; disable the REF1 (REFIN) frequency monitor (default). [5] = 1; enable the REF1 (REFIN) frequency monitor.								
01B	[4:0]	REFMON pin control	Selects the signal that is connected to the REFMON pin.								
			[4]	[3]	[2]	[1]	[0]	Level or Dynamic Signal	Signal at REFMON Pin		
			0	0	0	0	0	LVL	Ground, dc (default).		
			0	0	0	0	1	DYN	REF1 clock (differential reference when in differential mode).		
			0	0	0	1	0	DYN	REF2 clock (N/A in differential mode).		
			0	0	0	1	1	DYN	Selected reference to PLL (differential reference when in differential mode).		
			0	0	1	0	0	DYN	Unselected reference to PLL (not available in differential mode).		
			0	0	1	0	1	LVL	Status of selected reference (status of differential reference); active high.		
			0	0	1	1	0	LVL	Status of unselected reference (not available in differential mode); active high.		
			0	0	1	1	1	LVL	Status REF1 frequency (active high).		
			0	1	0	0	0	LVL	Status REF2 frequency (active high).		
			0	1	0	0	1	LVL	(Status REF1 frequency) AND (status REF2 frequency).		
			0	1	0	1	0	LVL	(DLD) AND (status of selected reference) AND (status of VCO).		
			0	1	0	1	1	LVL	Status of VCO frequency (active high).		
			0	1	1	0	0	LVL	Selected reference (low = REF1, high = REF2).		
			0	1	1	0	1	LVL	DLD; active low.		

# AD9522-4

Reg. Addr (Hex)	Bit(s)	Name	Description					Level or Dynamic Signal	Signal at REFMON Pin	
			[4]	[3]	[2]	[1]	[0]			
			0	1	1	1	0	LVL	Holdover active (active high).	
			0	1	1	1	1	LVL	LD pin comparator output (active high).	
			1	0	0	0	0	LVL	VS (PLL supply).	
			1	0	0	0	1	DYN	REF1 clock (differential reference when in differential mode).	
			1	0	0	1	0	DYN	REF2 clock (not available in differential mode).	
			1	0	0	1	1	DYN	Selected reference to PLL (differential reference when in differential mode).	
			1	0	1	0	0	DYN	Unselected reference to PLL (not available when in differential mode).	
			1	0	1	0	1	LVL	Status of selected reference (status of differential reference); active low.	
			1	0	1	1	0	LVL	Status of unselected reference (not available in differential mode); active low.	
			1	0	1	1	1	LVL	Status of REF1 frequency (active low).	
			1	1	0	0	0	LVL	Status of REF2 frequency (active low).	
			1	1	0	0	1	LVL	(Status of REF1 frequency) AND (status of REF2 frequency).	
			1	1	0	1	0	LVL	(DLD) AND (status of selected reference) AND (status of VCO).	
			1	1	0	1	1	LVL	Status of VCO frequency (active low).	
			1	1	1	0	0	LVL	Selected reference (low = REF2, high = REF1).	
			1	1	1	0	1	LVL	DLD; active low.	
			1	1	1	1	0	LVL	Holdover active (active low).	
			1	1	1	1	1	LVL	LD pin comparator output (active low).	
01C	[7]	Disable switchover deglitch	Disables or enables the switchover deglitch circuit. [7] = 0; enable the switchover deglitch circuit (default). [7] = 1; disable the switchover deglitch circuit.							
01C	[6]	Select REF2	If Register 0x01C[5] = 0, selects the reference for PLL when in manual; register selected reference control. [6] = 0; select REF1 (default). [6] = 1; select REF2.							
01C	[5]	Use REF_SEL pin	If Register 0x01C[4] = 0 (manual), sets the method of PLL reference selection. [5] = 0; use Register 0x01C[6] (default). [5] = 1; use REF_SEL pin.							
01C	[4]	Enable automatic reference switchover	Automatic or manual reference switchover. Single-ended reference mode must be selected by Register 0x01C[0] = 0. [4] = 0; manual reference switchover (default). [4] = 1; automatic reference switchover. Setting this bit also powers on REF1 and REF2, and overrides the settings in Register 0x01C[2:1].							
01C	[3]	Stay on REF2	Stays on REF2 after switchover. [3] = 0; return to REF1 automatically when REF1 status is good again (default). [3] = 1; stay on REF2 after switchover. Do not automatically return to REF1.							
01C	[2]	Enable REF2	This bit turns the REF2 power on. This bit is overridden when automatic reference switchover is enabled. [2] = 0; REF2 power off (default). [2] = 1; REF2 power on.							
01C	[1]	Enable REF1	This bit turns the REF1 power on. This bit is overridden when automatic reference switchover is enabled. [1] = 0; REF1 power off (default). [1] = 1; REF1 power on.							
01C	[0]	Enable differential reference	Selects the PLL reference mode, differential or single-ended. Register 0x01C[2:1] should be cleared when this bit is set. [0] = 0; single-ended reference mode (default). [0] = 1; differential reference mode.							



Reg. Addr (Hex)	Bit(s)	Name	Description															
01D	[7]	Enable Status_EEPROM at STATUS pin	Enables the Status_EEPROM signal at the STATUS pin. [7] = 0; the STATUS pin is controlled by the 0x017[7:2] selection. [7] = 1; select the Status_EEPROM signal at STATUS pin. This bit overrides 0x017[7:2] (default).															
01D	[6]	Enable XTAL OSC	Enables the maintaining amplifier needed by a crystal oscillator at the PLL reference input. [6] = 0; crystal oscillator maintaining amplifier disabled (default). [6] = 1; crystal oscillator maintaining amplifier enabled.															
01D	[5]	Enable clock doubler	Enable PLL reference input clock doubler. [5] = 0; doubler disabled (default). [5] = 1; doubler enabled.															
01D	[4]	Disable PLL status register	Disables the PLL status register readback. [4] = 0; PLL status register enabled (default). [4] = 1; PLL status register disabled. If this bit is set, Register 01F is not automatically updated.															
01D	[3]	Enable LD pin comparator	Enables the LD pin voltage comparator. This is used with the LD pin current source lock detect mode. When the AD9522 is in internal (automatic) holdover mode, this enables the use of the voltage on the LD pin to determine if the PLL was previously in a locked state (see Figure 47). Otherwise, this can be used with the REFMON and STATUS pins to monitor the voltage on the LD pin. [3] = 0; disable LD pin comparator and ignore the LD pin voltage; internal/automatic holdover controller treats this pin as true (high, default). [3] = 1; enable LD pin comparator (use LD pin voltage to determine if the PLL was previously locked).															
01D	[1]	Enable external holdover	Enables the external hold control through the SYNC pin. (This disables the internal holdover mode.) [1] = 0; automatic holdover mode, holdover controlled by automatic holdover circuit (default). [1] = 1; external holdover mode, holdover controlled by SYNC pin.															
01D	[0]	Enable holdover	Enables the internally controlled holdover function. [0] = 0; holdover disabled (default). [0] = 1; holdover enabled.															
01E	[4:3]	External zero delay feedback channel divider select	<table border="1"> <thead> <tr> <th>[4]</th> <th>[3]</th> <th>Selects Which Channel Divider to Use in the External Zero-Delay Path</th> </tr> </thead> <tbody> <tr> <td>0</td> <td>0</td> <td>Select Channel Divider 0 (default).</td> </tr> <tr> <td>0</td> <td>1</td> <td>Select Channel Divider 1.</td> </tr> <tr> <td>1</td> <td>0</td> <td>Select Channel Divider 2.</td> </tr> <tr> <td>1</td> <td>1</td> <td>Select Channel Divider 3</td> </tr> </tbody> </table>	[4]	[3]	Selects Which Channel Divider to Use in the External Zero-Delay Path	0	0	Select Channel Divider 0 (default).	0	1	Select Channel Divider 1.	1	0	Select Channel Divider 2.	1	1	Select Channel Divider 3
[4]	[3]	Selects Which Channel Divider to Use in the External Zero-Delay Path																
0	0	Select Channel Divider 0 (default).																
0	1	Select Channel Divider 1.																
1	0	Select Channel Divider 2.																
1	1	Select Channel Divider 3																
01E	[2]	Enable external zero delay	Selects which zero delay mode to use. [2] = 0; enables internal zero delay mode if 0x01E[1] = 1 (default). [2] = 1; enables external zero delay mode if 0x01E[1] = 1.															
01E	[1]	Enable zero delay	Enables zero delay function. [1] = 0; disables zero delay function (default). [1] = 1; enables zero delay function.															
01F	[6]	VCO calibration finished (read-only)	Readback register. Indicates the status of the VCO calibration. [6] = 0; VCO calibration not finished. [6] = 1; VCO calibration finished.															
01F	[5]	Holdover active (read-only)	Readback register. Indicates if the part is in the holdover state (see Figure 47). This is not the same as holdover enabled. [5] = 0; not in holdover. [5] = 1; holdover state active.															
01F	[4]	REF2 selected (read-only)	Readback register. Indicates which PLL reference is selected as the input to the PLL. [4] = 0; REF1 selected (or differential reference if in differential mode). [4] = 1; REF2 selected.															
01F	[3]	VCO frequency > threshold (read-only)	Readback register. Indicates if the VCO frequency is greater than the threshold (see Table 17, REF1, REF2, and VCO frequency status monitor parameter). [3] = 0; VCO frequency is less than the threshold. [3] = 1; VCO frequency is greater than the threshold.															

# AD9522-4

Reg. Addr (Hex)	Bit(s)	Name	Description
01F	[2]	REF2 frequency > threshold (read-only)	Readback register. Indicates if the frequency of the signal at REF2 is greater than the threshold frequency set by Register 0x01A[6]. [2] = 0; REF2 frequency is less than the threshold frequency. [2] = 1; REF2 frequency is greater than the threshold frequency.
01F	[1]	REF1 frequency > threshold (read-only)	Readback register. Indicates if the frequency of the signal at REF1 is greater than the threshold frequency set by Register 0x01A[6]. [1] = 0; REF1 frequency is less than the threshold frequency. [1] = 1; REF1 frequency is greater than the threshold frequency.
01F	[0]	Digital lock detect (read-only)	Readback register. Digital lock detect. [0] = 0; PLL is not locked. [0] = 1; PLL is locked.

**Table 53. Output Driver Control**

Reg. Addr (Hex)	Bit(s)	Name	Description					
0F0	[7]	OUT0 format	Selects the output type for OUT0. [7] = 0; LVDS (default). [7] = 1; CMOS.					
0F0	[6:5]	OUT0 CMOS configuration	Sets the CMOS output configuration for OUT0 when 0x0F0[7] = 1.					
			<b>[6:5]</b>	<b>OUT0A</b>	<b>OUT0B</b>			
			00	Tristate	Tristate			
			01	On	Tristate			
			10	Tristate	On			
11 (default)	On	On						
0F0	[4:3]	OUT0 polarity	Sets the output polarity for OUT0.					
			<b>[7]</b>	<b>[4]</b>	<b>[3]</b>	<b>Output Type</b>	<b>OUT0A</b>	<b>OUT0B</b>
			0 (default)	X	0	LVDS	Noninverting	Inverting
			0	X	1	LVDS	Inverting	Noninverting
			1	0 (default)	0 (default)	CMOS	Noninverting	Noninverting
			1	0	1	CMOS	Inverting	Inverting
			1	1	0	CMOS	Noninverting	Inverting
			1	1	1	CMOS	Inverting	Noninverting
0F0	[2:1]	OUT0 LVDS differential voltage	Sets the LVDS output differential voltage ( $V_{OD}$ ).					
			<b>[2]</b>	<b>[1]</b>	<b>I<sub>OD</sub> (mA)</b>			
			0	0	1.75 ( $V_{OD} = 175$ mV for 100 $\Omega$ termination across differential pair)			
			0 (default)	1 (default)	3.5 ( $V_{OD} = 350$ mV for 100 $\Omega$ termination across differential pair)			
			1	0	5.25 ( $V_{OD} = 525$ mV for 100 $\Omega$ termination across differential pair)			
1	1	7.0 ( $V_{OD} = 700$ mV for 100 $\Omega$ termination across differential pair)						
0F0	[0]	OUT0 LVDS power-down	LVDS power-down. [0] = 0; normal operation (default). [0] = 1; power-down. Output driver is in a high impedance state.					
0F1	[7:0]	OUT1 control	This register controls OUT1, and the bit assignments for this register are identical to Register 0x0F0.					
0F2	[7:0]	OUT2 control	This register controls OUT2, and the bit assignments for this register are identical to Register 0x0F0.					
0F3	[7:0]	OUT3 control	This register controls OUT3, and the bit assignments for this register are identical to Register 0x0F0.					
0F4	[7:0]	OUT4 control	This register controls OUT4, and the bit assignments for this register are identical to Register 0x0F0.					
0F5	[7:0]	OUT5 control	This register controls OUT5, and the bit assignments for this register are identical to Register 0x0F0.					

Reg. Addr (Hex)	Bit(s)	Name	Description												
0F6	[7:0]	OUT6 control	This register controls OUT6, and the bit assignments for this register are identical to Register 0x0F0.												
0F7	[7:0]	OUT7 control	This register controls OUT7, and the bit assignments for this register are identical to Register 0x0F0.												
0F8	[7:0]	OUT8 control	This register controls OUT8, and the bit assignments for this register are identical to Register 0x0F0.												
0F9	[7:0]	OUT9 control	This register controls OUT9, and the bit assignments for this register are identical to Register 0x0F0.												
0FA	[7:0]	OUT10 control	This register controls OUT10, and the bit assignments for this register are identical to Register 0x0F0.												
0FB	[7:0]	OUT11 control	This register controls OUT11, and the bit assignments for this register are identical to Register 0x0F0.												
0FC	[7]	CSDLD En OUT7	OUT7 is enabled only if CSDLD is high. <table border="1"> <thead> <tr> <th>[7]</th> <th>CSDLD Signal</th> <th>OUT7 Enable Status</th> </tr> </thead> <tbody> <tr> <td>0</td> <td>0</td> <td>Not affected by CSDLD signal (default).</td> </tr> <tr> <td>1</td> <td>0</td> <td>Asynchronous power-down.</td> </tr> <tr> <td>1</td> <td>1</td> <td>Asynchronously enable OUT7 if not powered down by other settings. To use this feature, the user must use current source digital lock detect, and set the enable LD pin comparator bit (0x01D[3]).</td> </tr> </tbody> </table>	[7]	CSDLD Signal	OUT7 Enable Status	0	0	Not affected by CSDLD signal (default).	1	0	Asynchronous power-down.	1	1	Asynchronously enable OUT7 if not powered down by other settings. To use this feature, the user must use current source digital lock detect, and set the enable LD pin comparator bit (0x01D[3]).
[7]	CSDLD Signal	OUT7 Enable Status													
0	0	Not affected by CSDLD signal (default).													
1	0	Asynchronous power-down.													
1	1	Asynchronously enable OUT7 if not powered down by other settings. To use this feature, the user must use current source digital lock detect, and set the enable LD pin comparator bit (0x01D[3]).													
0FC	[6]	CSDLD En OUT6	OUT6 is enabled only if CSDLD is high. Setting is identical to Register 0x0FC[7].												
0FC	[5]	CSDLD En OUT5	OUT5 is enabled only if CSDLD is high. Setting is identical to Register 0x0FC[7].												
0FC	[4]	CSDLD En OUT4	OUT4 is enabled only if CSDLD is high. Setting is identical to Register 0x0FC[7].												
0FC	[3]	CSDLD En OUT3	OUT3 is enabled only if CSDLD is high. Setting is identical to Register 0x0FC[7].												
0FC	[2]	CSDLD En OUT2	OUT2 is enabled only if CSDLD is high. Setting is identical to Register 0x0FC[7].												
0FC	[1]	CSDLD En OUT1	OUT1 is enabled only if CSDLD is high. Setting is identical to Register 0x0FC[7].												
0FC	[0]	CSDLD En OUT0	OUT0 is enabled only if CSDLD is high. Setting is identical to Register 0x0FC[7].												
0FD	[3]	CSDLD En OUT11	OUT11 is enabled only if CSDLD is high. Setting is identical to Register 0x0FC[7].												
0FD	[2]	CSDLD En OUT10	OUT10 is enabled only if CSDLD is high. Setting is identical to Register 0x0FC[7].												
0FD	[1]	CSDLD En OUT9	OUT9 is enabled only if CSDLD is high. Setting is identical to Register 0x0FC[7].												
0FD	[0]	CSDLD En OUT8	OUT8 is enabled only if CSDLD is high. Setting is identical to Register 0x0FC[7].												

Table 54. LVDS Channel Dividers

Reg. Addr (Hex)	Bit(s)	Name	Description
190	[7:4]	Divider 0 low cycles	Number of clock cycles (minus 1) of the divider input during which divider output stays low. A value of 0x7 means the divider is low for eight input clock cycles (default: 0x7).
190	[3:0]	Divider 0 high cycles	Number of clock cycles (minus 1) of the divider input during which divider output stays high. A value of 0x7 means the divider is high for eight input clock cycles (default: 0x7).
191	[7]	Divider 0 bypass	Bypasses and powers down the divider; routes input to divider output. [7] = 0; use divider (default). [7] = 1; bypass divider.
191	[6]	Divider 0 ignore SYNC	Ignore SYNC. [6] = 0; obey chip-level SYNC signal (default). [6] = 1; ignore chip-level SYNC signal.
191	[5]	Divider 0 force high	Forces divider output to high. This requires that ignore SYNC also be set. [5] = 0; divider output forced to low (default). [5] = 1; divider output forced to high.
191	[4]	Divider 0 start high	Selects clock output to start high or start low. [4] = 0; start low (default). [4] = 1; start high.
191	[3:0]	Divider 0 phase offset	Phase offset (default: 0x0).

# AD9522-4

Reg. Addr (Hex)	Bit(s)	Name	Description
192	[2]	Channel 0 power-down	Channel 0 powers down. [2] = 0; normal operation (default). [2] = 1; powered down. ( $\overline{\text{OUT0}}/\overline{\text{OUT0}}$ , $\overline{\text{OUT1}}/\overline{\text{OUT1}}$ , and $\overline{\text{OUT2}}/\overline{\text{OUT2}}$ are put into the high impedance power-down mode by setting this bit.)
192	[0]	Disable Divider 0 DCC	Duty-cycle correction function. [0] = 0; enable duty-cycle correction (default). [0] = 1; disable duty-cycle correction.
193	[7:4]	Divider 1 low cycles	Number of clock cycles (minus 1) of the divider input during which the divider output stays low. A value of 0x3 means the divider is low for four input clock cycles (default: 0x3).
193	[3:0]	Divider 1 high cycles	Number of clock cycles (minus 1) of the divider input during which the divider output stays high. A value of 0x3 means the divider is high for four input clock cycles (default: 0x3).
194	[7]	Divider 1 bypass	Bypasses and powers down the divider; routes input to divider output. [7] = 0; use divider (default). [7] = 1; bypass divider.
194	[6]	Divider 1 ignore SYNC	Ignore SYNC. [6] = 0; obey chip-level SYNC signal (default). [6] = 1; ignore chip-level SYNC signal.
194	[5]	Divider 1 force high	Forces divider output to high. This requires that ignore SYNC also be set. [5] = 0; divider output forced to low (default). [5] = 1; divider output forced to high.
194	[4]	Divider 1 start high	Selects clock output to start high or start low. [4] = 0; start low (default). [4] = 1; start high.
194	[3:0]	Divider 1 phase offset	Phase offset (default: 0x0).
195	[2]	Channel 1 power-down	Channel 1 powers down. [2] = 0; normal operation (default). [2] = 1; powered down. ( $\overline{\text{OUT3}}/\overline{\text{OUT3}}$ , $\overline{\text{OUT4}}/\overline{\text{OUT4}}$ , and $\overline{\text{OUT5}}/\overline{\text{OUT5}}$ are put into the high impedance power-down mode by setting this bit.)
195	[0]	Disable Divider 1 DCC	Duty-cycle correction function. [0] = 0; enable duty-cycle correction (default). [0] = 1; disable duty-cycle correction.
196	[7:4]	Divider 2 low cycles	Number of clock cycles (minus 1) of the divider input during which the divider output stays low. A value of 0x1 means the divider is low for two input clock cycles (default: 0x1).
196	[3:0]	Divider 2 high cycles	Number of clock cycles (minus 1) of the divider input during which the divider output stays high. A value of 0x1 means the divider is high for two input clock cycles (default: 0x1).
197	[7]	Divider 2 bypass	Bypasses and powers down the divider; routes input to divider output. [7] = 0; use divider (default). [7] = 1; bypass divider.
197	[6]	Divider 2 ignore SYNC	Ignore SYNC. [6] = 0; obey chip-level SYNC signal (default). [6] = 1; ignore chip-level SYNC signal.
197	[5]	Divider 2 force high	Forces divider output to high. This requires that ignore SYNC also be set. [5] = 0; divider output forced to low (default). [5] = 1; divider output forced to high.
197	[4]	Divider 2 start high	Selects clock output to start high or start low. [4] = 0; start low (default). [4] = 1; start high.
197	[3:0]	Divider 2 phase offset	Phase offset (default: 0x0).

Reg. Addr (Hex)	Bit(s)	Name	Description
198	[2]	Channel 2 power-down	Channel 2 powers down. [2] = 0; normal operation (default). [2] = 1; powered down. (OUT6/ $\overline{\text{OUT6}}$ , OUT7/ $\overline{\text{OUT7}}$ , and OUT8/ $\overline{\text{OUT8}}$ are put into the high impedance power-down mode by setting this bit.)
198	[0]	Disable Divider 2 DCC	Duty-cycle correction function. [0] = 0; enable duty-cycle correction (default). [0] = 1; disable duty-cycle correction.
199	[7:4]	Divider 3 low cycles	Number of clock cycles (minus 1) of the divider input during which the divider output stays low. A value of 0x0 means the divider is low for one input clock cycle (default: 0x0).
199	[3:0]	Divider 3 high cycles	Number of clock cycles (minus 1) of the divider input during which the divider output stays high. A value of 0x0 means the divider is high for one input clock cycle (default: 0x0).
19A	[7]	Divider 3 bypass	Bypasses and powers down the divider; routes input to divider output. [7] = 0; use divider (default). [7] = 1; bypass divider.
19A	[6]	Divider 3 ignore SYNC	Ignore SYNC. [6] = 0; obey chip-level SYNC signal (default). [6] = 1; ignore chip-level SYNC signal.
19A	[5]	Divider 3 force high	Forces divider output to high. This requires that ignore SYNC also be set. [5] = 0; divider output forced to low (default). [5] = 1; divider output forced to high.
19A	[4]	Divider 3 start high	Selects clock output to start high or start low. [4] = 0; start low (default). [4] = 1; start high.
19A	[3:0]	Divider 3 phase offset	Phase offset (default: 0x0).
19B	[2]	Channel 3 power-down	Channel 3 powers down. [2] = 0; normal operation (default). [2] = 1; powered down. (OUT9/ $\overline{\text{OUT9}}$ , OUT10/ $\overline{\text{OUT10}}$ , and OUT11/ $\overline{\text{OUT11}}$ are put into the high impedance power-down mode by setting this bit.)
19B	[0]	Disable Divider 3 DCC	Duty-cycle correction function. [0] = 0; enable duty-cycle correction (default). [0] = 1; disable duty-cycle correction.

Table 55. VCO Divider and CLK Input

Reg. Addr (Hex)	Bit(s)	Name	Description			
			[2]	[1]	[0]	Divide
1E0	[2:0]	VCO divider	0	0	0	2 (default)
			0	0	1	3
			0	1	0	4
			0	1	1	5
			1	0	0	6
			1	0	1	Output static
			1	1	0	1 (bypass)
			1	1	1	Output static
1E1	[4]	Power-down clock input section	Powers down the clock input section (including CLK buffer, VCO divider, and CLK tree). [4] = 0; normal operation (default). [4] = 1; power down.			

# AD9522-4

Reg. Addr (Hex)	Bit(s)	Name	Description
1E1	[3]	Power-down VCO clock interface	Powers down the interface block between VCO and clock distribution. [3] = 0; normal operation (default). [3] = 1; power down.
1E1	[2]	Power-down VCO and CLK	Powers down both the CLK input and VCO. [2] = 0; normal operation (default). [2] = 1; power down.
1E1	[1]	Select VCO or CLK	Selects either the VCO or the CLK as the input to VCO divider. [1] = 0; select external CLK as input to VCO divider (default). [1] = 1; select VCO as input to VCO divider; cannot bypass VCO divider when this is selected. This bit must be set to use the PLL with the internal VCO.
1E1	[0]	Bypass VCO divider	Bypasses or uses the VCO divider. [0] = 0; use VCO divider (default). [0] = 1; bypass VCO divider; cannot select VCO as input when this is selected.

Table 56. System

Reg. Addr (Hex)	Bit(s)	Name	Description
230	[3]	Disable power-on SYNC	Power-on SYNC mode. Used to disable the antiruntpulse circuitry. [3] = 0; enable the antiruntpulse circuitry (default). [3] = 1; disable the antiruntpulse circuitry.
230	[2]	Power-down SYNC	Powers down the SYNC function. [2] = 0; normal operation of the SYNC function (default). [2] = 1; power-down SYNC circuitry.
230	[1]	Power-down distribution reference	Powers down the reference for the distribution section. [1] = 0; normal operation of the reference for the distribution section (default). [1] = 1; powers down the reference for the distribution section.
230	[0]	Soft SYNC	The soft SYNC bit works the same as the $\overline{\text{SYNC}}$ pin, except that the polarity of the bit is reversed; that is, a high level forces selected channels into a predetermined static state, and a 1-to-0 transition triggers a SYNC. [0] = 0; same as $\overline{\text{SYNC}}$ high. [0] = 1; same as $\overline{\text{SYNC}}$ low.

Table 57. Update All Registers

Reg. Addr (Hex)	Bit(s)	Name	Description
232	[0]	IO_UPDATE	This bit must be set to 1 to transfer the contents of the buffer registers into the active registers. This happens on the next SCLK rising edge. This bit is self-clearing; that is, it does not have to be set back to 0. [0] = 1 (self-clearing); update all active registers to the contents of the buffer registers.

Table 58. EEPROM Buffer Segment

Reg. Addr (Hex)	Bit(s)	Name	Description
A00 to A16	[7:0]	EEPROM Buffer Segment Register 1 to EEPROM Buffer Segment Register 23	The EEPROM buffer segment section stores the starting address and number of bytes that are to be stored and read back to and from the EEPROM. Because the AD9522 register space is noncontiguous, the EEPROM controller needs to know the starting address and number of bytes in the AD9522 register space to store and retrieve from the EEPROM. In addition, there are special instructions for the EEPROM controller, operational codes (that is, IO_UPDATE and end-of-data) that are also stored in the EEPROM buffer segment. The on-chip default setting of the EEPROM buffer segment registers is designed such that all registers are transferred to/from the EEPROM, and an IO_UPDATE is issued after transfer. See the Programming the EEPROM Buffer Segment section for more information.

Table 59. EEPROM Control

Reg. Addr (Hex)	Bit(s)	Name	Description
B00	[0]	STATUS_EEPROM (read-only)	This read-only register indicates the status of the data transferred between the EEPROM and the buffer register bank during the writing and reading of the EEPROM. This signal is also available at the STATUS pin when 0x01D[7] is set. [0] = 0; data transfer is done. [0] = 1; data transfer is not done.
B01	[0]	EEPROM data error (read-only)	This read-only register indicates an error during the data transferred between the EEPROM and the buffer. [0] = 0; no error. Data is correct. [0] = 1; incorrect data detected.
B02	[1]	Soft_EEPROM	When the EEPROM pin is tied low, setting Soft_EEPROM resets the AD9522 using the settings saved in EEPROM. [1] = 1; soft reset with EEPROM settings (self-clearing). This bit self clears on the next serial port clock cycle after the completion of writing to this register.
B02	[0]	Enable EEPROM write	Enables the user to write to the EEPROM. [0] = 0; EEPROM write protection is enabled. User cannot write to EEPROM (default). [0] = 1; EEPROM write protection is disabled. User can write to EEPROM.
B03	[0]	REG2EEPROM	Transfers data from the buffer register to the EEPROM (self-clearing). [0] = 1; setting this bit initiates the data transfer from the buffer register to the EEPROM (writing process); it is reset by the I <sup>2</sup> C master after the data transfer is done.

## APPLICATIONS INFORMATION

### FREQUENCY PLANNING USING THE AD9522

The AD9522 is a highly flexible PLL. When choosing the PLL settings and version of the AD9522, the following guidelines should be kept in mind.

The AD9522 has four frequency dividers: the reference (or R) divider, the feedback (or N) divider, the VCO divider, and the channel divider. When trying to achieve a particularly difficult frequency divide ratio requiring a large amount of frequency division, some of the frequency division can be done by either the VCO divider or the channel divider, thus allowing a higher phase detector frequency and more flexibility in choosing the loop bandwidth.

Within the AD9522 family, lower VCO frequencies generally result in slightly better jitter. The difference in integrated jitter (from 12 kHz to 20 MHz offset) for the same output frequency is usually less than 150 fs over the entire VCO frequency range (1.4 GHz to 2.95 GHz) of the AD9522 family. If the desired frequency plan can be achieved with a version of the AD9522 that has a lower VCO frequency, choosing the lower frequency part results in the best phase noise and the lowest jitter. However, choosing a higher VCO frequency can result in more flexibility in frequency planning.

Choosing a nominal charge pump current in the middle of the allowable range as a starting point allows the designer to increase or decrease the charge pump current, and thus allows the designer to fine-tune the PLL loop bandwidth in either direction.

ADIsimCLK is a powerful PLL modeling tool that can be downloaded from [www.analog.com](http://www.analog.com) and is a very accurate tool for determining the optimal loop filter for a given application.

### USING THE AD9522 OUTPUTS FOR ADC CLOCK APPLICATIONS

Any high speed ADC is extremely sensitive to the quality of the sampling clock of the AD9522. An ADC can be thought of as a sampling mixer, and any noise, distortion, or time jitter on the clock is combined with the desired signal at the analog-to-digital output. Clock integrity requirements scale with the analog input frequency and resolution, with higher analog input frequency applications at  $\geq 14$ -bit resolution being the most stringent. The theoretical SNR of an ADC is limited by the ADC resolution and the jitter on the sampling clock. Considering an ideal ADC of infinite resolution where the step size and quantization error can be ignored, the available SNR can be expressed approximately by

$$SNR(\text{dB}) = 20 \log \left( \frac{1}{2\pi f_A t_j} \right)$$

where:

$f_A$  is the highest analog frequency being digitized.

$t_j$  is the rms jitter on the sampling clock.

Figure 70 shows the required sampling clock jitter as a function of the analog frequency and effective number of bits (ENOB).



Figure 70. SNR and ENOB vs. Analog Input Frequency

See the AN-756 Application Note and the AN-501 Application Note at [www.analog.com](http://www.analog.com).

Many high performance ADCs feature differential clock inputs to simplify the task of providing the required low jitter clock on a noisy PCB. Distributing a single-ended clock on a noisy PCB can result in coupled noise on the sampling clock. Differential distribution has inherent common-mode rejection that can provide superior clock performance in a noisy environment. The differential LVDS outputs of the AD9522 enable clock solutions that maximize converter SNR performance.

The input requirements of the ADC (differential or single-ended, logic level termination) should be considered when selecting the best clocking/converter solution. In some cases, the LVPECL outputs of the AD9522 may be desirable for clocking a converter instead of the LVDS outputs of the AD9522.

### LVDS CLOCK DISTRIBUTION

The AD9522 provides clock outputs that are selectable as either CMOS or LVDS level outputs. LVDS is a differential output option that uses a current mode output stage. The nominal current is 3.5 mA, which yields 350 mV output swing across a 100  $\Omega$  resistor. An output current of 7 mA is also available in cases where a larger output swing is required. The LVDS output meets or exceeds all ANSI/TIA/EIA-644 specifications.



A recommended termination circuit for the LVDS outputs is shown in Figure 71. If ac coupling is necessary, place decoupling capacitors either before or after the 100  $\Omega$  termination resistor.

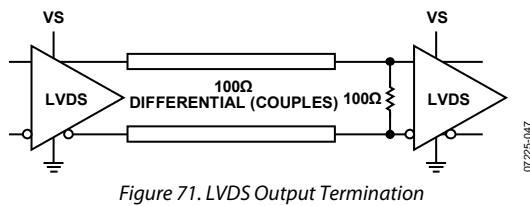

Figure 71. LVDS Output Termination

See the AN-586 Application Note at [www.analog.com](http://www.analog.com) for more information on LVDS.

### CMOS CLOCK DISTRIBUTION

The output drivers of the AD9522 can be configured as CMOS drivers. When selected as a CMOS driver, each output becomes a pair of CMOS outputs, each of which can be individually turned on or off and set as inverting or noninverting. These outputs are 3.3 V CMOS compatible.

When single-ended CMOS clocking is used, some of the following guidelines apply.

Point-to-point connections should be designed such that each driver has only one receiver, if possible. Connecting outputs in this manner allows for simple termination schemes and minimizes ringing due to possible mismatched impedances on the output trace. Series termination at the source is generally required to provide transmission line matching and/or to reduce current transients at the driver.

The value of the resistor is dependent on the board design and timing requirements (typically 10  $\Omega$  to 100  $\Omega$  is used). CMOS outputs are also limited in terms of the capacitive load or trace length that they can drive. Typically, trace lengths less than 3 inches are recommended to preserve signal rise/fall times and signal integrity.

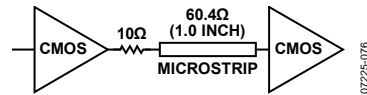

Figure 72. Series Termination of CMOS Output

Termination at the far end of the PCB trace is a second option. The CMOS outputs of the AD9522 do not supply enough current to provide a full voltage swing with a low impedance resistive, far-end termination, as shown in Figure 73. The far-end termination network should match the PCB trace impedance and provide the desired switching point. The reduced signal swing may still meet receiver input requirements in some applications. This can be useful when driving long trace lengths on less critical nets.

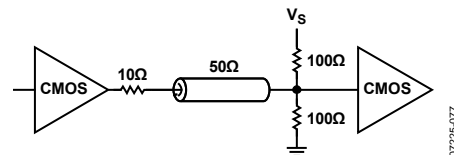
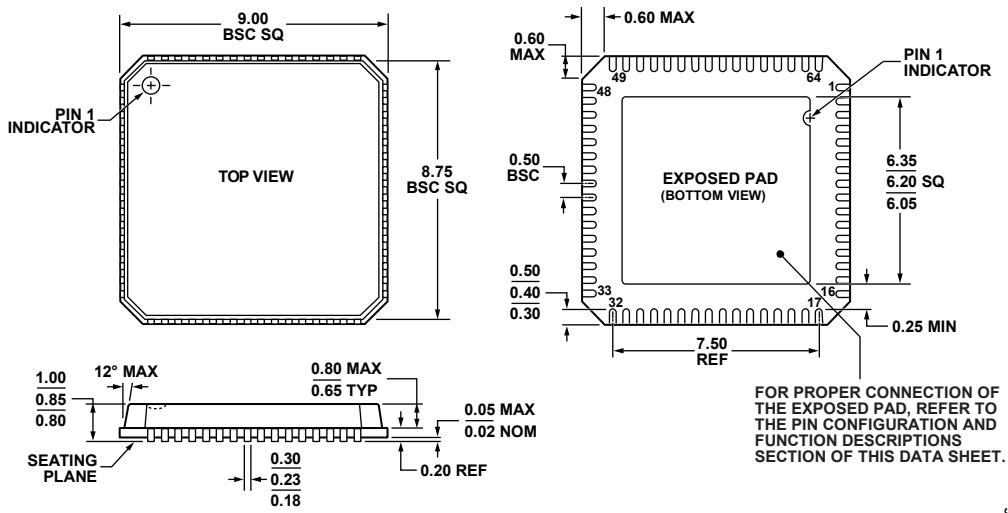

Figure 73. CMOS Output with Far-End Termination

Because of the limitations of single-ended CMOS clocking, consider using differential outputs when driving high speed signals over long traces. The AD9522 offers LVDS outputs that are better suited for driving long traces where the inherent noise immunity of differential signaling provides superior performance for clocking converters.

## OUTLINE DIMENSIONS



COMPLIANT TO JEDEC STANDARDS MO-220-VMM4-4

Figure 74. 64-Lead Lead Frame Chip Scale Package [LFCSP\_VQ]  
 9 mm × 9 mm Body, Very Thin Quad  
 CP-64-4  
 Dimensions shown in millimeters

091707-C

## ORDERING GUIDE

Model	Temperature Range	Package Description	Package Option
AD9522-4BCPZ <sup>1</sup>	-40°C to +85°C	64-Lead Lead Frame Chip Scale Package (LFCSP_VQ)	CP-64-4
AD9522-4BCPZ-REEL7 <sup>1</sup>	-40°C to +85°C	64-Lead Lead Frame Chip Scale Package (LFCSP_VQ)	CP-64-4
AD9522-4/PCBZ <sup>1</sup>		Evaluation Board	

<sup>1</sup> Z = RoHS Compliant Part.

**NOTES**

**AD9522-4**

**NOTES**

Компания «Океан Электроники» предлагает заключение долгосрочных отношений при поставках импортных электронных компонентов на взаимовыгодных условиях!

Наши преимущества:

- Поставка оригинальных импортных электронных компонентов напрямую с производств Америки, Европы и Азии, а так же с крупнейших складов мира;
- Широкая линейка поставок активных и пассивных импортных электронных компонентов (более 30 млн. наименований);
- Поставка сложных, дефицитных, либо снятых с производства позиций;
- Оперативные сроки поставки под заказ (от 5 рабочих дней);
- Экспресс доставка в любую точку России;
- Помощь Конструкторского Отдела и консультации квалифицированных инженеров;
- Техническая поддержка проекта, помощь в подборе аналогов, поставка прототипов;
- Поставка электронных компонентов под контролем ВП;
- Система менеджмента качества сертифицирована по Международному стандарту ISO 9001;
- При необходимости вся продукция военного и аэрокосмического назначения проходит испытания и сертификацию в лаборатории (по согласованию с заказчиком);
- Поставка специализированных компонентов военного и аэрокосмического уровня качества (Xilinx, Altera, Analog Devices, Intersil, Interpoint, Microsemi, Actel, Aeroflex, Peregrine, VPT, Syfer, Eurofarad, Texas Instruments, MS Kennedy, Miteq, Cobham, E2V, MA-COM, Hittite, Mini-Circuits, General Dynamics и др.);

Компания «Океан Электроники» является официальным дистрибьютором и эксклюзивным представителем в России одного из крупнейших производителей разъемов военного и аэрокосмического назначения «JONHON», а так же официальным дистрибьютором и эксклюзивным представителем в России производителя высокотехнологичных и надежных решений для передачи СВЧ сигналов «FORSTAR».



## JONHON

«JONHON» (основан в 1970 г.)

Разъемы специального, военного и аэрокосмического назначения:

(Применяются в военной, авиационной, аэрокосмической, морской, железнодорожной, горно- и нефтедобывающей отраслях промышленности)

«FORSTAR» (основан в 1998 г.)

ВЧ соединители, коаксиальные кабели, кабельные сборки и микроволновые компоненты:

(Применяются в телекоммуникациях гражданского и специального назначения, в средствах связи, РЛС, а так же военной, авиационной и аэрокосмической отраслях промышленности).



Телефон: 8 (812) 309-75-97 (многоканальный)

Факс: 8 (812) 320-03-32

Электронная почта: [ocean@oceanchips.ru](mailto:ocean@oceanchips.ru)

Web: <http://oceanchips.ru/>

Адрес: 198099, г. Санкт-Петербург, ул. Калинина, д. 2, корп. 4, лит. А