

DESCRIPTION

The MP24833 is a 55V, 3A, white LED driver suitable for step-down, inverting step-up/down and step-up applications. It achieves 3A output current over a wide input supply range with excellent load and line regulation. Current mode operation provides fast transient response and eases loop stabilization. Fault condition protection includes thermal shutdown, cycle-by-cycle peak current limiting, open strings protection and output short circuit protection.

The MP24833 incorporates both DC and PWM dimming onto a single control pin. The separate input reference ground pin allows for direct enable and/or dimming control for a positive to negative power conversion.

The MP24833 requires a minimal number of readily-available standard external components and is available in an SOIC8E package.

FEATURES

- 3A Maximum Output Current
- Unique Step-Up/Down Operation (Buck-Boost Mode)
- Wide 4.5V-to-55V Operating Input Range for Step-Down Applications (Buck Mode)
- 0.19Ω Internal Power MOSFET Switch
- Fixed 200kHz Switching Frequency
- Analog and PWM Dimming
- 0.198V Reference Voltage
- 6μA Shutdown Mode
- No Minimum Number of LEDs Required
- Stable with Low ESR Output Ceramic Capacitors
- Cycle-by-Cycle Over-Current Protection
- Thermal Shutdown Protection
- Open Strings Protection
- Output Short-Circuit Protection
- Available in an SOIC8E Package

APPLICATIONS

- General LED Illumination
- LCD Backlight Panels
- Notebook Computers
- Automotive Internal Lighting
- Portable Multimedia Players
- Portable GPS Devices

All MPS parts are lead-free, halogen free, and adhere to the RoHS directive. For MPS green status, please visit MPS website under Quality Assurance.

"MPS" and "The Future of Analog IC Technology" are Registered Trademarks of Monolithic Power Systems, Inc.

TYPICAL APPLICATION

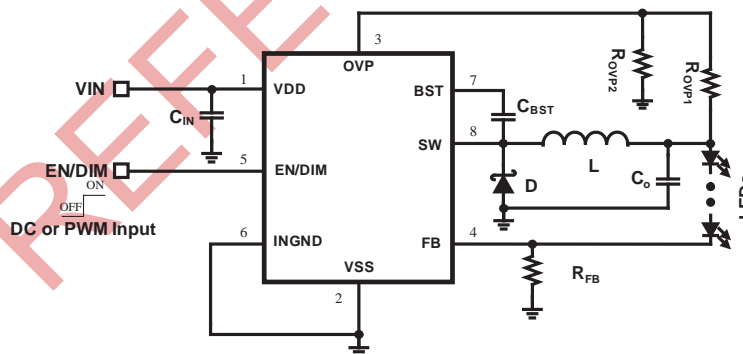

ORDERING INFORMATION

Part Number*	Package	Top Marking
MP24833GN	SOIC-8 EP	MP24833

* For Tape & Reel, add suffix -Z (e.g. MP24833GN-Z).

PACKAGE REFERENCE

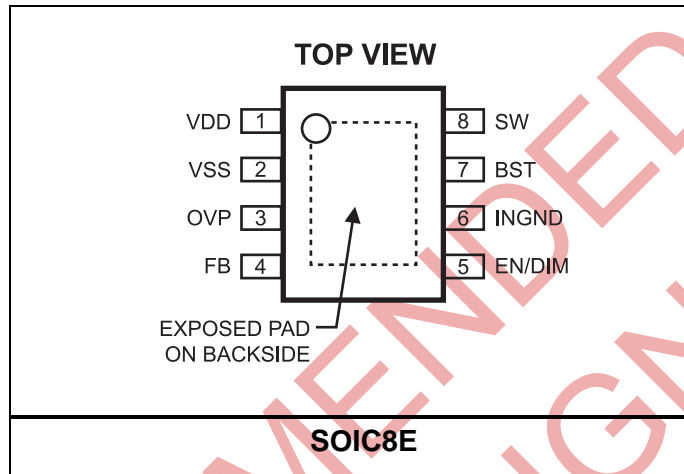

ABSOLUTE MAXIMUM RATINGS ⁽¹⁾

Supply Voltage $V_{DD} - V_{SS}$	60V
$V_{SW} - V_{SS}$	-0.3V to $V_{IN} + 0.3V$
V_{BST}	$V_{SW} + 6V$
$V_{EN/Dim} - V_{INGND}$	-0.3V to +6V
$V_{INGND} - V_{SS}$	-0.3V to 60V
Other pins - V_{SS}	-0.3V to +6V
Continuous Power Dissipation ($T_A = +25^\circ C$) ⁽²⁾	
SOIC8E	2.5W
Junction Temperature	150°C
Lead Temperature	260°C
Storage Temperature	-65°C to +150°C

Recommended Operating Conditions ⁽³⁾

Supply Voltage $V_{DD} - V_{SS}$	4.5V to 55V
Operating Junction Temp. (T_J)	-40°C to +125°C

Thermal Resistance ⁽⁴⁾

	θ_{JA}	θ_{JC}
SOIC-8 EP	50	10 ... °C/W

Notes:

- 1) Exceeding these ratings may damage the device.
- 2) The maximum allowable power dissipation is a function of the maximum junction temperature T_J (MAX), the junction-to-ambient thermal resistance θ_{JA} , and the ambient temperature T_A . The maximum allowable continuous power dissipation at any ambient temperature is calculated by P_D (MAX) = $(T_J$ (MAX) - T_A) / θ_{JA} . Exceeding the maximum allowable power dissipation will cause excessive die temperature, and the regulator will go into thermal shutdown. Internal thermal shutdown circuitry protects the device from permanent damage.
- 3) The device function is not guaranteed outside of the recommended operating conditions.
- 4) Measured on JESD51-7, 4-layer PCB.

ELECTRICAL CHARACTERISTICS

$V_{IN} = 12V$, $T_A = 25^\circ C$, all voltages with respect to V_{SS} , unless otherwise noted.

Parameters	Symbol	Condition	Min	Typ	Max	Units
Feedback Voltage	V_{FB}	$4.5V \leq V_{IN} \leq 55V$	0.188	0.198	0.208	V
Feedback Current	I_{FB}	$V_{FB} = 0.22V$	-50		50	nA
Switch-On Resistance ⁽⁵⁾	$R_{DS(ON)}$			190		m Ω
Switch Leakage		$V_{EN} = 0V, V_{SW} = 0V$			1	μA
Current Limit ⁽⁵⁾		Duty=0		5		A
Oscillator Frequency	f_{SW}			200		kHz
Fold-back Frequency		$V_{FB} = 0V, V_{OVP}=0V$		36		kHz
Maximum Duty Cycle		$V_{FB} = 0.19V$		91		%
Minimum On-Time ⁽⁵⁾	t_{ON}			100		ns
Under Voltage Lockout Threshold Rising			3	3.3	3.6	V
Under Voltage Lockout Threshold Hysteresis				200		mV
EN Input Current		$V_{EN} = 2V$			2.1	μA
EN OFF Threshold (w/Respect to INGND)		V_{EN} Falling	0.4			V
EN ON Threshold (w/Respect to INGND)		V_{EN} Rising			0.6	V
Minimum EN Dimming Threshold		$V_{FB} = 0V$	0.6	0.67	0.75	V
Maximum EN Dimming Threshold		$V_{FB} = 0.2V$	1.25	1.36	1.47	V
Supply Current (Quiescent)	I_Q	$V_{EN} = 2V, V_{FB} = 1V$		0.6	0.8	mA
Supply Current (Quiescent) at EN Off	I_{off}	$V_{EN}=0V$		6	12	μA
Thermal Shutdown ⁽⁵⁾				150		$^\circ C$
Open LED OV Threshold	V_{OVP_th}		1.1	1.2	1.3	V
Open LED OV Hysteresis	V_{OVP_hys}			60		mV

Notes:

5) Guaranteed by design.

TYPICAL CHARACTERISTICS

Shutdown Current vs. T_J

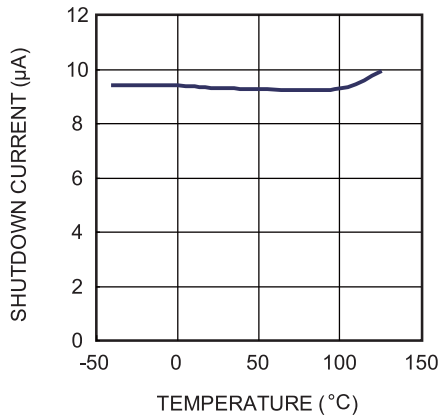

Quiescent Current vs. T_J

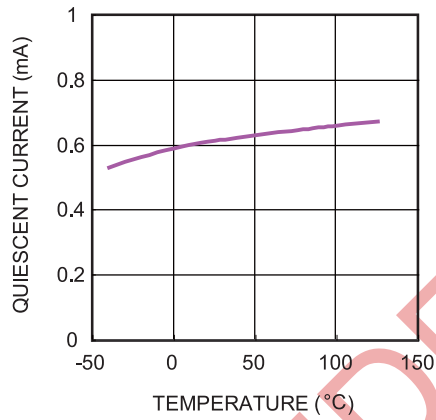

Feedback Reference vs. T_J

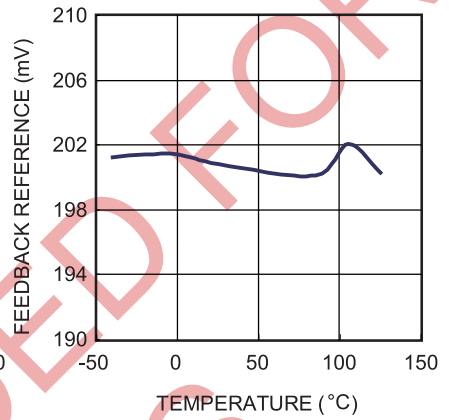

UVLO vs. T_J

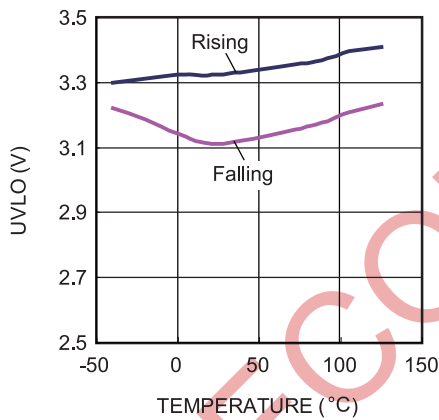

OVP Threshold vs. T_J

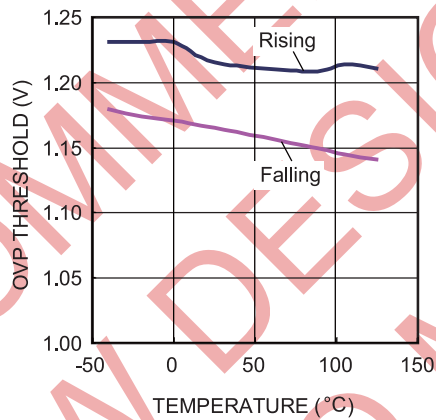

Oscillator Frequency vs. T_J

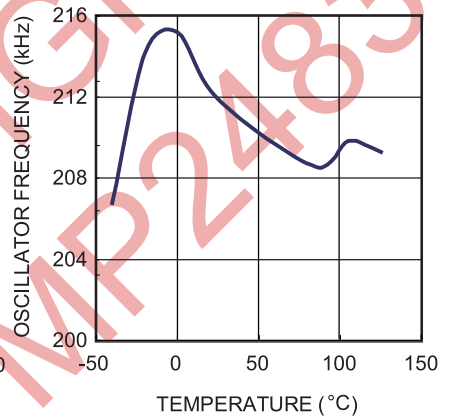

Current Limit vs. T_J

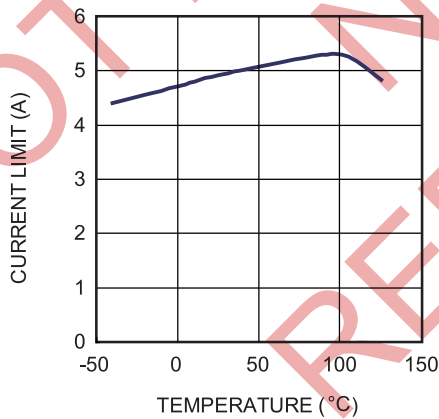

EN Threshold vs. T_J

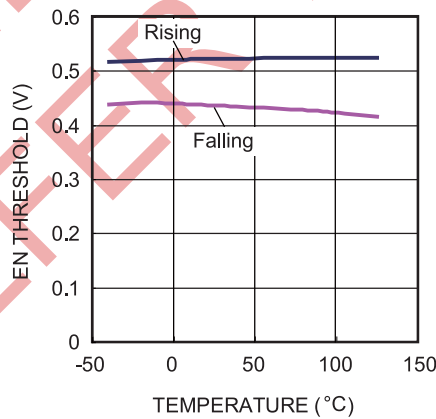

Dimming Threshold vs. T_J

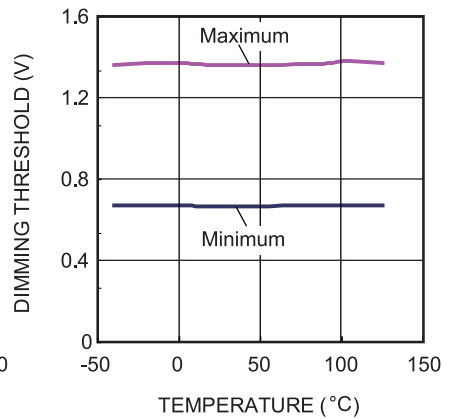

TYPICAL PERFORMANCE CHARACTERISTICS

Performance waveforms are tested on the evaluation board of the Design Example section. $V_{IN} = 36V$, $I_{LED} = 1A$, 7WLEDs in series, $L = 68\mu H$, $T_A = 25^\circ C$, Buck Application, unless otherwise noted.

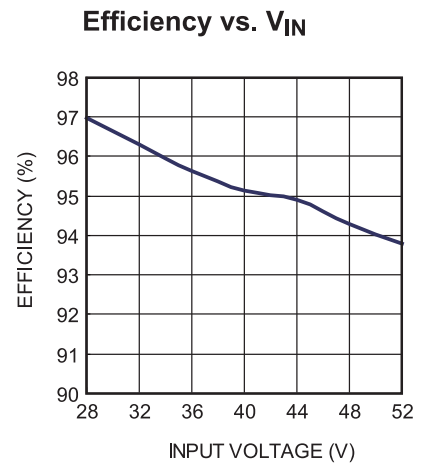
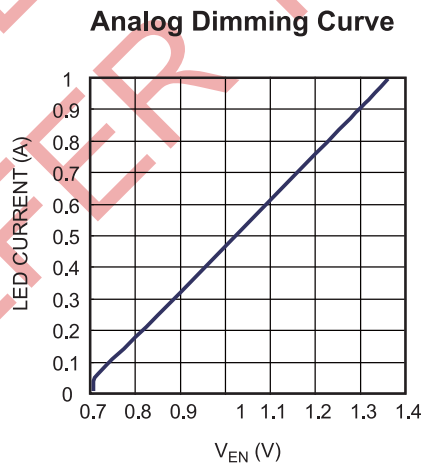
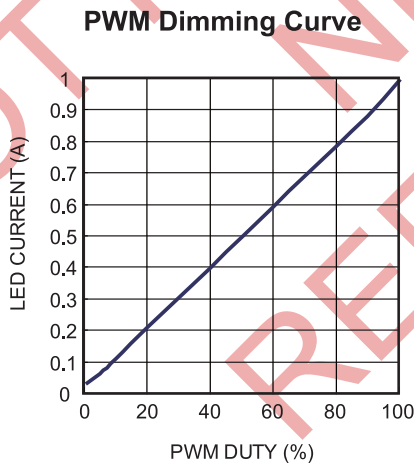
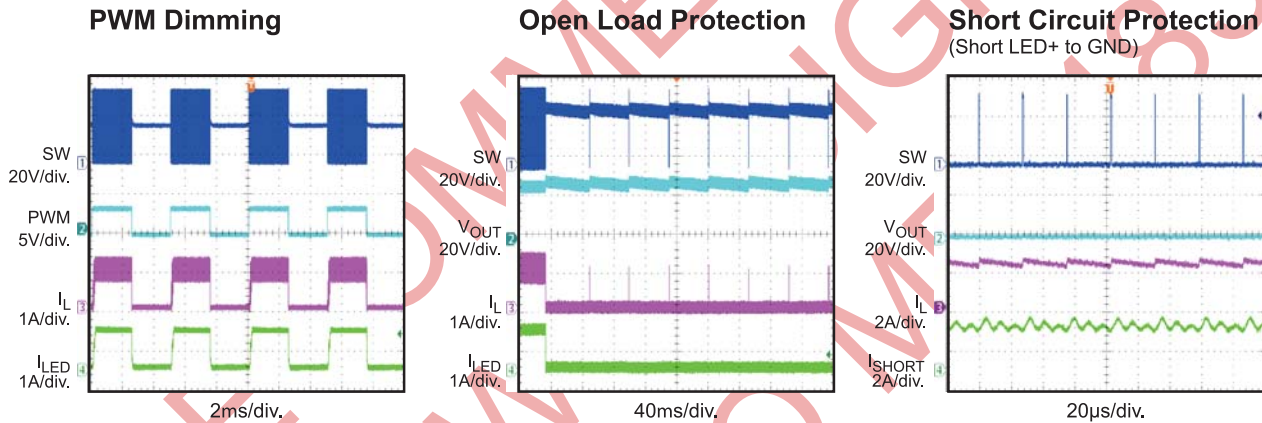
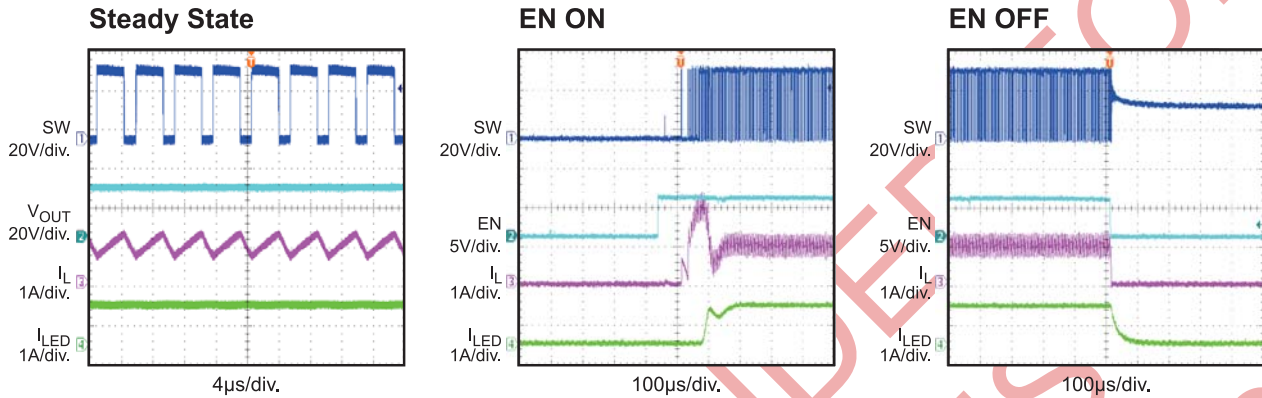

TYPICAL PERFORMANCE CHARACTERISTICS *(continued)*

Performance waveforms are tested on the evaluation board of the Design Example section. $V_{IN} = 24V$, $I_{LED} = 1A$, 7WLEDs in series, $L = 68\mu H$, $T_A = 25^\circ C$, Buck-boost Application, Refer to INGND, unless otherwise noted.

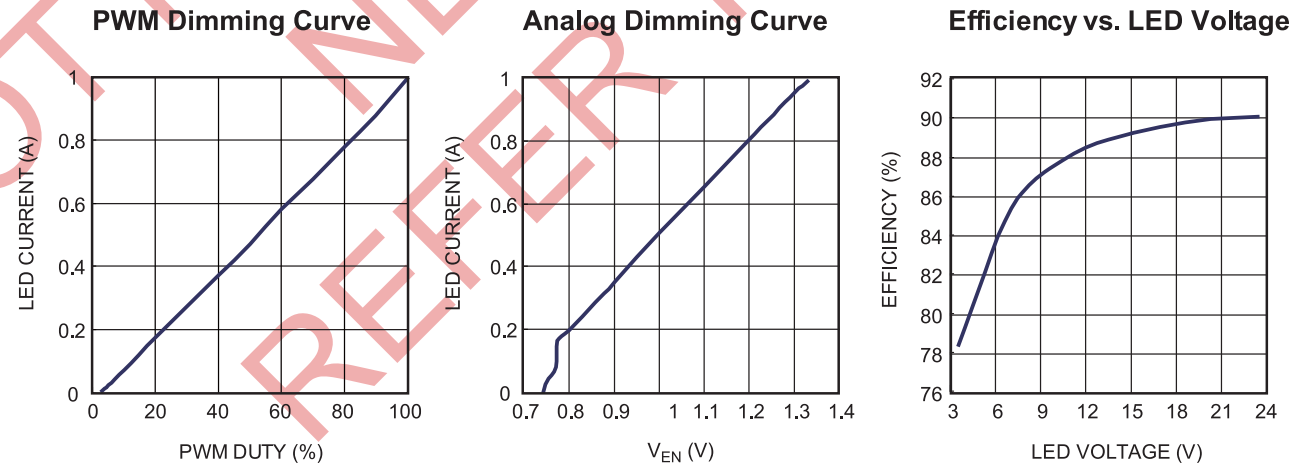
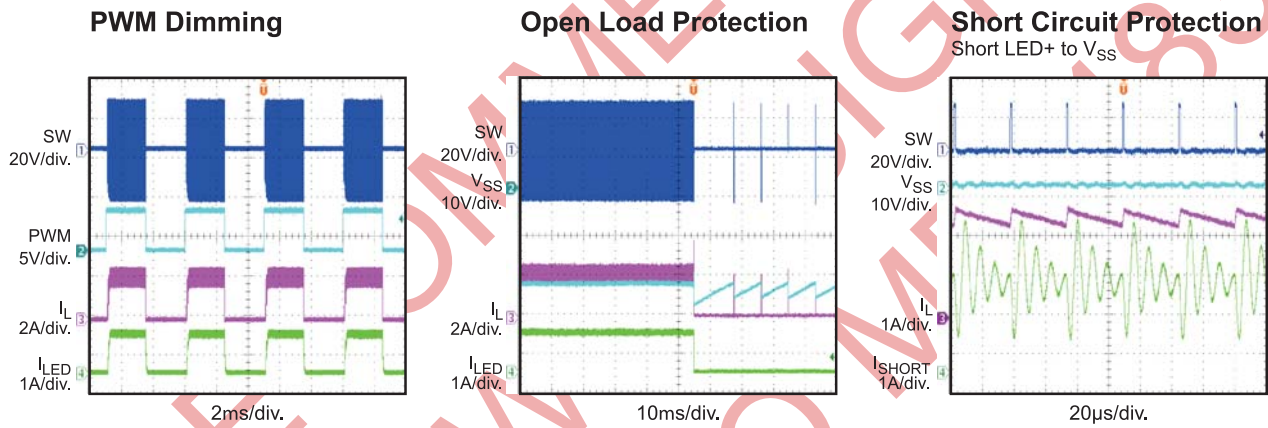
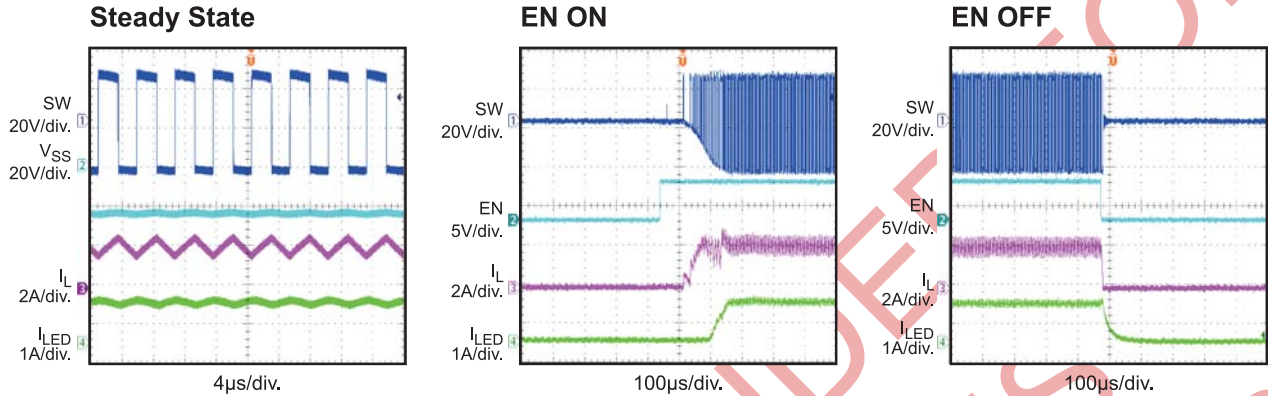

PIN FUNCTIONS

Pin #	Name	Description
1	VDD	Supply Voltage. The MP24833 operates from a 4.5V to 55V unregulated input (with respect to VSS). Input capacitor is needed to prevent large voltage spikes from appearing at the input.
2	VSS, exposed pad	Power Return. Connect to the lowest potential in the circuit, which is typically the anode of the Schottky rectifier. This pin is the voltage reference for the regulated output voltage, and thus requires extra care in layout. The exposed pad is also connected to this pin
3	OVP	Over-Voltage Protection. Use a voltage divider to program the OVP threshold. When the OVP pin voltage reaches the shutdown threshold of 1.2V, the switch turns off and will recover when the OVP voltage drops to normal operating range. When the voltage (with respect to VSS) drops below 0.2V and the FB pin voltage is less than 0.1V, the chip treats this as a short circuit and the operating frequency folds back. Program the OVP pin voltage from 0.2V to 1.2V for normal operation.
4	FB	LED Current Feedback Input. Senses the current across the sensing resistor between FB and VSS. Connect the current sensing resistor from the bottom of the LED strings to VSS. The FB pin is connected to the bottom of the LED strings. The regulation voltage is 0.198V.
5	EN/DIM	On/Off Control Input and Dimming Command Input. A voltage greater than 0.67V will turn on the chip. This pin implements both DC and PWM dimming. When the EN/DIM pin voltage (with respect to INGND) rises from 0.67V to 1.36V, the LED current will change from 0% to 100% of the maximum LED current. To use PWM dimming, apply a 100Hz-to-2kHz square wave signal with amplitude greater than 1.5V to this pin. For combined analog and PWM dimming, apply a 100HZ to 2kHz square wave signal with amplitude from 0.67V to 1.36V.
6	INGND	Input Ground Reference. This pin is the reference for the EN/DIM signal.
7	BST	Bootstrap. Connect a capacitor between SW and BST pin to form a floating supply for the power switch driver. Use a 100nF or larger ceramic capacitor to provide sufficient energy to drive the power switch with this supply voltage.
8	SW	Switch Output. Source of the internal MOSFET. Connect this pin to the power inductor and the cathode of the rectifier diode.

FUNCTIONAL BLOCK DIAGRAM

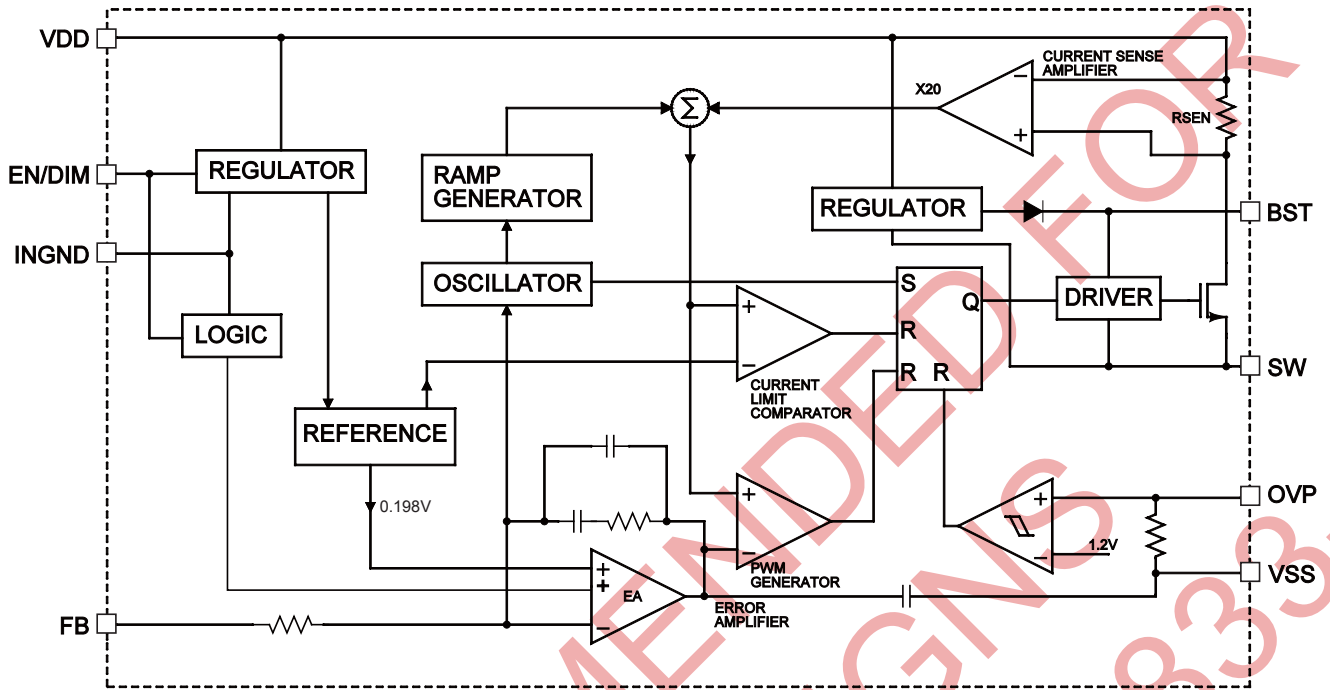

Figure 1: Functional Block Diagram

OPERATION

The MP24833 is a current-mode regulator. The error amplifier (EA) output voltage is proportional to the peak inductor current.

At the beginning of a cycle, the MOSFET is off. The EA output voltage is higher than the current sense amplifier output, and the current comparator's output is low. The rising edge of the CLK signal (its frequency is the operating frequency) sets the RS flip-flop. Its output turns on the MOSFET that connects the SW pin and inductor to the input supply.

The current sense amplifier detects and amplifies the rising inductor current. The PWM comparator compares the output of the EA against the sum of the ramp compensator and the current sense amplifier. When the sum of the current sense amplifier output and the slope compensation signal exceeds the EA output voltage, the RS flip-flop resets and the MOSFET turns off. The external Schottky rectifier diode (D) conducts the inductor current.

If the sum of the current sense amplifier output and the slope compensation signal does not exceed the EA output throughout the cycle, then the falling edge of the CLK resets the flip-flop.

The output of the EA integrates the voltage difference between the feedback and the 0.198V reference. The EA output will increase when the FB pin voltage less than 0.198V. Since the EA output voltage is proportional to the peak inductor current, The increase in EA output voltage also increases the current delivered to the output.

Soft Start

When the MP24833 is enabled and VDD exceeds the UVLO threshold, the switching begins. The soft-start is not active when $V_{FB}-V_{SS}$ is lower than 1/2 of V_{REF} , which is helpful to charge the output cap quickly. At the same time, the current limit is folded to half.

Once $V_{FB}-V_{SS}$ rises up to 1/2 of V_{REF} , the soft-start begins and forces the internal reference input of the EA rises up from 2/3 of V_{REF} slowly. The current limit also recovers the normal value. The soft-start function can keep the duty cycle

extend slowly to limit the current overshoot at start-up.

When the internal reference input of the EA rises up to around $V_{REF}+100mV$, the soft-start ends and the reference input of the EA is connected to full scale of V_{REF} (0.198V).

Open LED Protection

The OVP pin is used for open LED protection. It monitors the output voltage through a voltage divider. If the LED is open, there is no voltage on the FB pin. The duty cycle will increase until $V_{OVP}-V_{SS}$ reaches the protection threshold set by the external resistor divider. The top switch turns off until $V_{OVP}-V_{SS}$ decreases sufficiently.

Dimming Control

The MP24833 allows both DC and PWM dimming. When the voltage on EN (reference to INGND) is less than 0.6V, the chip turns off. For analog dimming, the LED current is linearly dependent on the EN voltage range between 0.67V and 1.36V, from 0% to 100%. EN voltage higher than 1.36V results in the maximum LED current generated. For PWM dimming, ($V_{DIM} - V_{INGND}$) must exceed 1.5V. Use a PWM frequency in the range of 100Hz to 2kHz for good dimming linearity. For combined analog and PWM dimming, apply a PWM signal with amplitude from 0.67V to 1.36V to EN pin.

Output Short Circuit Protection

The MP24833 features output short-circuit protection. When the output is shorted to VSS, the voltage on OVP pin drops below 0.2V, and the FB pin senses no voltage (<0.1V) as no current goes through the WLED. Under this condition, the operating frequency folds back to decrease the power consumption.

In Boost or Buck-boost applications when there is possibility that the LED+ short circuit to VSS, in series a 100ohm resistor from powerGND to Pin INGND of the IC to protect the IC

APPLICATION INFORMATION

Setting the LED Current

The external resistor sets the maximum LED current (refer to TYPICAL APPLICATION CIRCUIT) and value can be determined using the equation:

$$R_{\text{SENSE}} = \frac{0.198\text{V}}{I_{\text{LED}}}$$

Setting Over-Voltage Protection

The voltage divider sets the over-voltage protection point (refer to TYPICAL APPLICATION CIRCUIT) through the equation:

$$V_{\text{OVP}} = 1.2\text{V} \times \frac{R_{\text{OVP1}} + R_{\text{OVP2}}}{R_{\text{OVP2}}}$$

Normally, the OVP point is setting about 10%-30% higher than LED voltage.

Selecting the Inductor (Step-Down Application, refer to Figure 3. Please refer to the design example for buck-boost application)

Include an inductor with a value ranging from 10 μH to 220 μH with a DC current rating higher than the maximum inductor current for most applications. Include the DC resistance of the inductor when estimating the output current and the power consumption on the inductor.

For Buck converter designs, derive the required inductance value from the following equation.

$$L = \frac{V_{\text{OUT}} \times (V_{\text{IN}} - V_{\text{OUT}})}{V_{\text{IN}} \times \Delta I_L \times f_s}$$

Choose the inductor ripple current to be 30% (usually in range of 30% to 60%) of the maximum load current. The maximum inductor peak current is calculated from:

$$I_{L_{\text{peak}}} = I_{L_{\text{AVG}}} + \frac{\Delta I_L}{2}$$

Where the $I_{L_{\text{AVG}}}$ is the average current through the inductor, it is equal to the output load current (LED current) for buck application.

Under light-load conditions below 100mA, use a larger inductor for improved efficiency.

Selecting the Input Capacitor

The input capacitor reduces the surge current drawn from the input supply and the switching noise from the device. Chose an input capacitor with a switching-frequency impedance that is less than the input source impedance to prevent high-frequency switching current from passing through the input. Use ceramic capacitors with X5R or X7R dielectrics if possible because of their low ESR and small temperature coefficients.

Select a capacitance that can limit the input voltage ripple ΔV_{IN} , which is normally less than 5% to 10% of the DC value. For buck application, it is:

$$C_{\text{IN}} > \frac{I_{\text{LED}} \times V_{\text{OUT}} \times (V_{\text{IN}} - V_{\text{OUT}})}{\Delta V_{\text{IN}} \times f_s \times V_{\text{IN}}^2}$$

For most applications, use a 4.7 μF capacitor.

Please refer to the design example for buck-boost application.

Selecting the Output Capacitor

The output capacitor keeps the output voltage ripple small and ensures a stable feedback loop. Select an output capacitor with low impedance at the switching frequency. Use ceramic capacitors with X5R or X7R dielectrics for their low ESR characteristics. For buck application, the output capacitor is selected as following equation:

$$C_{\text{OUT}} > \frac{\Delta I_L}{8\Delta V_{\text{OUT}} \times f_s}$$

A 2.2 μF to 10 μF ceramic capacitor will suffice for most applications.

Please refer to the design example for the buck-boost application.

PC Board Layout

Place the high current paths (VSS, VDD and SW) close to the device with short, direct and wide traces. Place the input capacitor as close as possible to the VDD and VSS pins as possible. Place the external feedback resistors next to the FB pin. Keep the switch node traces short and away from the feedback network.

Pay special attention to the switching frequency loop layout—keep the loop as small as possible.

For buck applications, the switching frequency loop is composed of the input capacitor, the internal power MOSFET and the Schottky diode. Place the Schottky diode close to the IC (VDD and SW pins) and the input capacitor.

For buck-boost or boost application, the switching frequency loop is composed of the input capacitor, the internal MOSFET, the Schottky diode and the output capacitor. Make the loop as small as possible. Place the output capacitor close to the input capacitor and the IC.

NOT RECOMMENDED FOR
NEW DESIGNS
REFER TO MP24833-A

Design Example

Use the step-up/down application for example to show the design procedure.

Specifications

Input: 24V, DC;

Output: LED current 1A maximum, LED voltage 24V;

Operating frequency: ~200 kHz.

Selecting LED Current Sense Resistor

Determine the LED current sense resistor from the following equation

$$R_{\text{sense}} = \frac{0.198V}{I_{\text{LED}}} \approx 200\text{m}\Omega$$

Considering power consumption, use two 400mΩ resistors with 1206 package in parallel for LED current sense resistor.

Selecting Inductor

The converter operates in continuous current mode (CCM), determine the inductor value as follows:

$$L = \frac{V_{\text{IN}} \times V_{\text{OUT}}}{(V_{\text{IN}} + V_{\text{OUT}}) \times \Delta I_L \times f_s}$$

Where ΔI_L is the inductor peak-to-peak current ripple. Select ΔI_L at 40% (usually from 30% to 60%) of the inductor average current, which is:

$$I_{L_AVG} = I_{\text{LED}} \cdot \left(1 + \frac{V_{\text{OUT}}}{V_{\text{IN}}}\right).$$

The inductance is 75μH, select a 68μH inductor, the current ripple of inductor is about 0.88A. The peak current of inductor is:

$$I_{L_peak} = I_{L_AVG} + \frac{1}{2} \Delta I_L$$

PCB LAYOUT

Layout is based on EV24833-N-00A

The peak current is about 2.5A. Select an inductor with saturation current around 3A.

Select Input and Output Capacitor

The input capacitor reduces the surge current drawn from the input supply and the switching noise from the device. Select a capacitance that can limit the input voltage ripple ΔV_{IN} , which is normally less than 5% to 10% of the DC value.

$$C_{\text{IN}} > \frac{I_{\text{LED}} \cdot V_{\text{OUT}}}{f_s \cdot \Delta V_{\text{IN}} \cdot (V_{\text{IN}} + V_{\text{OUT}})}$$

The output capacitor keeps the output voltage ripple ΔV_{OUT} small (normally less than 1% to 5% of the DC value) and ensures feedback loop stability.

$$C_{\text{OUT}} > \frac{I_{\text{LED}} \cdot V_{\text{OUT}}}{f_s \cdot \Delta V_{\text{OUT}} \cdot (V_{\text{IN}} + V_{\text{OUT}})}$$

Use two 2.2μF/50V X7R ceramic capacitors in parallel as the input capacitor, and use a 4.7μF/50V X7R ceramic capacitor as the output capacitor.

Select Rectifier Diode

Use a Schottky diode as the rectifier diode. Select a diode that can withstand voltage stress higher than 48V, and the current limit higher than the output current. Use B360 in this application.

Setting Open Voltage Protection

Set the OVP point 20% higher than maximum output voltage by voltage divider.

$$V_{\text{OVP}} = 1.2V \times \frac{R_{\text{OVP1}} + R_{\text{OVP2}}}{R_{\text{OVP2}}}$$

The OVP setting resistor is R9=10kΩ and R8=226kΩ

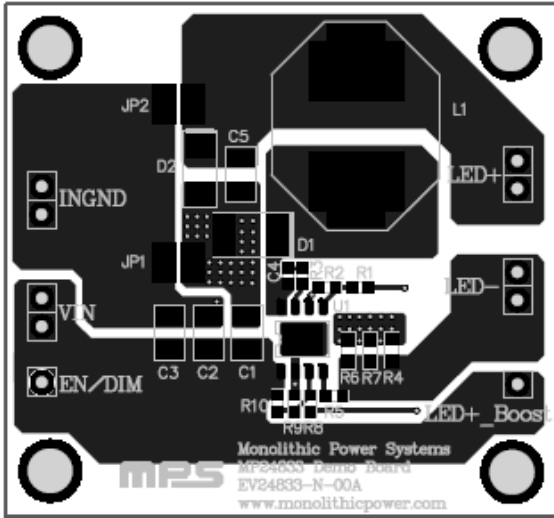

Figure 5—Top Layer

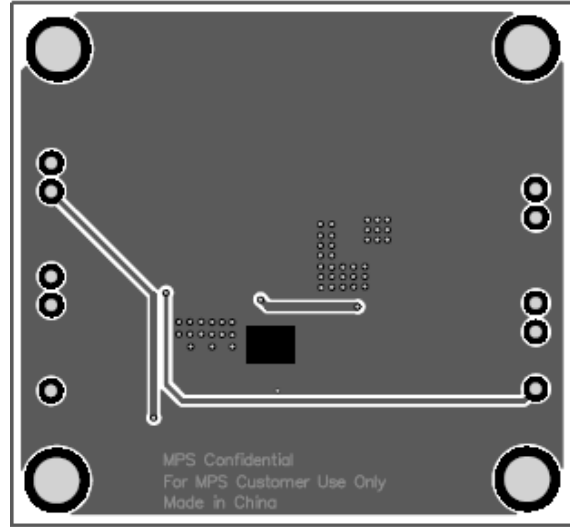
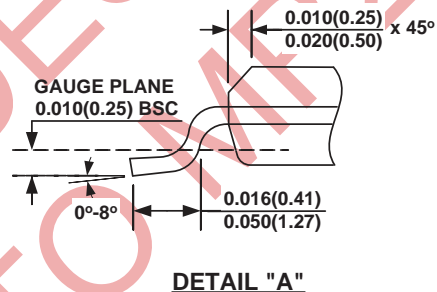
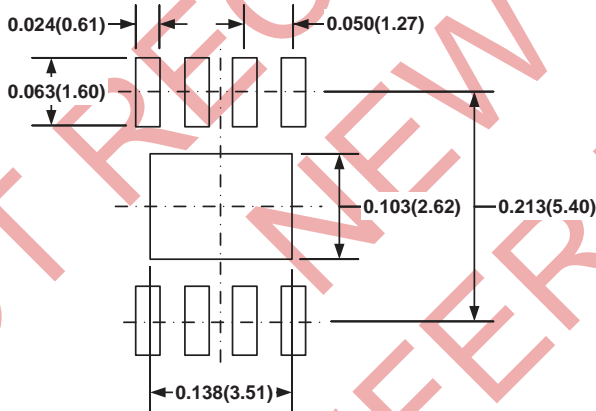
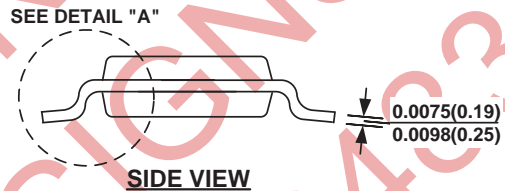
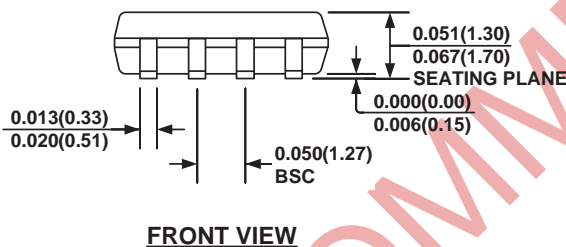
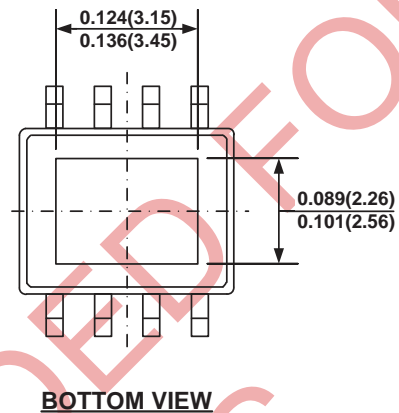
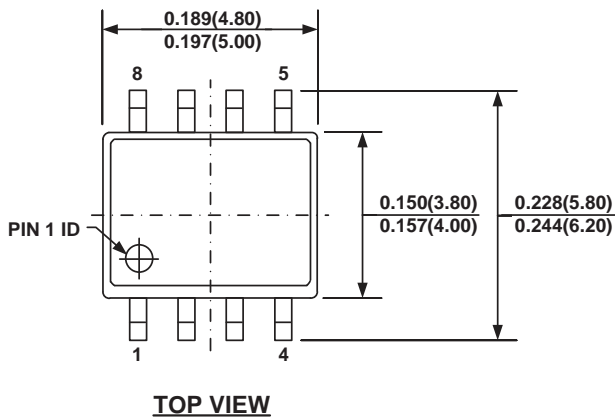

Figure 6—Bottom Layer

NOT RECOMMENDED FOR NEW DESIGNING REFER TO MP24833-A

PACKAGE INFORMATION

SOIC-8 (EP)



NOTE:

- 1) CONTROL DIMENSION IS IN INCHES. DIMENSION IN BRACKET IS IN MILLIMETERS.
- 2) PACKAGE LENGTH DOES NOT INCLUDE MOLD FLASH, PROTRUSIONS OR GATE BURRS.
- 3) PACKAGE WIDTH DOES NOT INCLUDE INTERLEAD FLASH OR PROTRUSIONS.
- 4) LEAD COPLANARITY (BOTTOM OF LEADS AFTER FORMING) SHALL BE 0.004" INCHES MAX.
- 5) DRAWING CONFORMS TO JEDEC MS-012, VARIATION BA.
- 6) DRAWING IS NOT TO SCALE.

NOTICE: The information in this document is subject to change without notice. Users should warrant and guarantee that third party Intellectual Property rights are not infringed upon when integrating MPS products into any application. MPS will not assume any legal responsibility for any said applications.

Компания «Океан Электроники» предлагает заключение долгосрочных отношений при поставках импортных электронных компонентов на взаимовыгодных условиях!

Наши преимущества:

- Поставка оригинальных импортных электронных компонентов напрямую с производств Америки, Европы и Азии, а так же с крупнейших складов мира;
- Широкая линейка поставок активных и пассивных импортных электронных компонентов (более 30 млн. наименований);
- Поставка сложных, дефицитных, либо снятых с производства позиций;
- Оперативные сроки поставки под заказ (от 5 рабочих дней);
- Экспресс доставка в любую точку России;
- Помощь Конструкторского Отдела и консультации квалифицированных инженеров;
- Техническая поддержка проекта, помощь в подборе аналогов, поставка прототипов;
- Поставка электронных компонентов под контролем ВП;
- Система менеджмента качества сертифицирована по Международному стандарту ISO 9001;
- При необходимости вся продукция военного и аэрокосмического назначения проходит испытания и сертификацию в лаборатории (по согласованию с заказчиком);
- Поставка специализированных компонентов военного и аэрокосмического уровня качества (Xilinx, Altera, Analog Devices, Intersil, Interpoint, Microsemi, Actel, Aeroflex, Peregrine, VPT, Syfer, Eurofarad, Texas Instruments, MS Kennedy, Miteq, Cobham, E2V, MA-COM, Hittite, Mini-Circuits, General Dynamics и др.);

Компания «Океан Электроники» является официальным дистрибьютором и эксклюзивным представителем в России одного из крупнейших производителей разъемов военного и аэрокосмического назначения «**JONHON**», а так же официальным дистрибьютором и эксклюзивным представителем в России производителя высокотехнологичных и надежных решений для передачи СВЧ сигналов «**FORSTAR**».



JONHON

«**JONHON**» (основан в 1970 г.)

Разъемы специального, военного и аэрокосмического назначения:

(Применяются в военной, авиационной, аэрокосмической, морской, железнодорожной, горно- и нефтедобывающей отраслях промышленности)

«**FORSTAR**» (основан в 1998 г.)

ВЧ соединители, коаксиальные кабели,
кабельные сборки и микроволновые компоненты:

(Применяются в телекоммуникациях гражданского и специального назначения, в средствах связи, РЛС, а так же военной, авиационной и аэрокосмической отраслях промышленности).



Телефон: 8 (812) 309-75-97 (многоканальный)

Факс: 8 (812) 320-03-32

Электронная почта: ocean@oceanchips.ru

Web: <http://oceanchips.ru/>

Адрес: 198099, г. Санкт-Петербург, ул. Калинина, д. 2, корп. 4, лит. А