



FEATURES

- Low Cost! Highly reliable!
- Proven SMT-on-pcb construction
- Designed to meet UL/EN/IEC 60950-1, CAN/CSA-C22.2 60950-1
- Qual tested; HALT tested; EMC tested
- Small packages, 2" x 1" x 0.375"
- Standard pinouts
- 5, 5.2, 12 or 15 Volt outputs
- Choice of 3 wide-range inputs:
 - 4.7-7.25 Volts
 - 9-18 Volts
 - 18-75 Volts
- Fully isolated, 1500Vdc guaranteed
- -40 to +100°C operation
- 5-side metal shielded cases with non-conductive baseplates
- Modifications and customs for OEM's

PRODUCT OVERVIEW

Placing reliability and cost considerations above all others, DATEL's new A-Series DC/DC Converters combine straightforward circuit topologies, the newest components, proven SMT-on-pcb construction, and highly repeatable automatic assembly techniques. Considering the critical low-cost and long-term-reliability requirements of today's telecom, datacom and computer/networking applications, the A-Series may well be the most cost-effective DC/DC's available today.

The single-output, 6-10 Watt Models of the A-Series deliver both high power densities and impressive MTBF's. Their superior durability is substantiated by a rigorous in-house qualification program including HALT (Highly Accelerated Life Testing). The goal of HALT is not to simulate field conditions but to expose devices to multiple excessive stresses with the intention of precipitating any potential electrical, mechanical or process weaknesses.

Packaged in 2" x 1" x 0.375" shielded metal cases with non-conductive coatings, these fully isolated (1500Vdc guaranteed) DC/DC's offer excellent line/load regulation, full I/O protection, and industry-standard pinouts.

Output voltages include 5, 5.2, 12 and 15 Volts. Input voltage ranges are either 4.7-7.25V ("D5A" models), 9-18V ("D12A" models) or 18-75V ("D48A" models). All A-Series UWR models are fully EMI characterized and agency safety approved.

A-Series DC/DC's are extremely reliable, easy-to-use, cost-effective power converters. Use them to improve the reliability of existing equipment or to develop new systems that exceed design objectives.

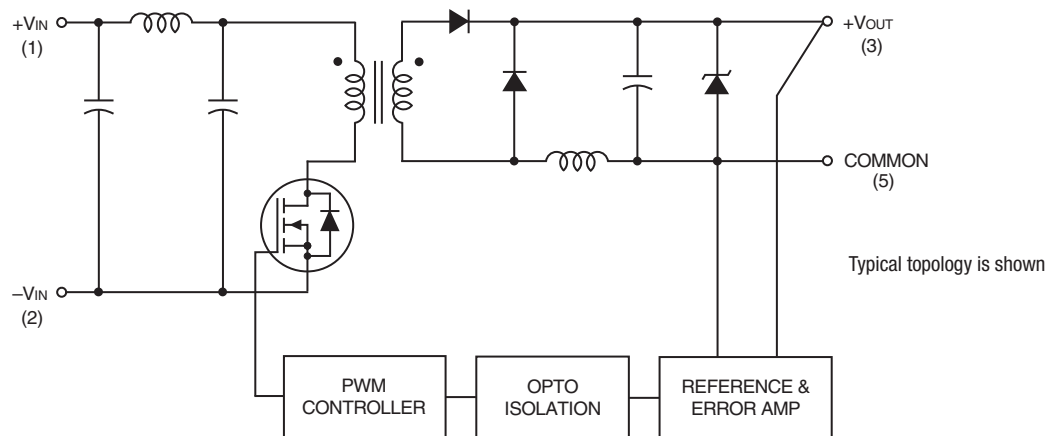

Figure 1. Simplified Schematic



Performance Specifications and Ordering Guide ①

Root Model ⑥	Output				Input			Efficiency		Package (Case, Pinout)		
	V _{OUT} * (Volts)	I _{OUT} (mA)	R/N (mVp-p) ②		Regulation (Max.)		V _{IN} Nom. (Volts)	Range (Volts)	I _{IN} ④ (mA)		Min.	Typ.
			Typ.	Max.	Line	Load ③						
UWR-5/1600-D5A-C	5	1600	50	100	±0.2%	±0.5%	5	4.7-7.25	20/2105	74%	76%	C2, P11
UWR-5/1800-D48A-C	5	1800	75	100	±0.2%	±0.5%	48	18-75	10/240	78%	81%	C2, P11
UWR-5/2000-D12A-C	5	2000	50	75	±0.2%	±0.5%	12	9-18	15/1029	79.5%	81%	C2, P11
UWR-5/2000-D24E-C ⑤	5	2000	50	75	±0.2%	±0.5%	24	18-36	10/490	83%	85%	C2, P11
UWR-5/2000-D48E-C ⑤	5	2000	50	75	±0.2%	±0.5%	48	36-72	10/248	82%	84%	C2, P11
UWR-5.2/1500-D5A-C	5.2	1500	50	100	±0.2%	±0.5%	5	4.7-7.25	20/2053	74%	76%	C2, P11
UWR-12/665-D5A-C	12	665	75	100	±0.2%	±0.5%	5	4.7-7.25	25/2046	75%	78%	C2, P11
UWR-12/750-D48A-C	12	750	75	100	±0.2%	±0.5%	48	18-75	10/230	81.5%	82.5%	C2, P11
UWR-12/830-D12A-C	12	830	75	100	±0.2%	±0.5%	12	9-18	35/988	81%	84%	C2, P11
UWR-15/530-D5A-C	15	530	50	100	±0.2%	±0.5%	5	4.7-7.25	40/2065	75%	77%	C2, P11
UWR-15/600-D48A-C	15	600	75	100	±0.2%	±0.5%	48	18-75	10/233	81.5%	84%	C2, P11
UWR-15/665-D12A-C	15	665	75	100	±0.2%	±0.5%	12	9-18	35/978	82%	85%	C2, P11

- ① Typical at T_A = +25°C under nominal line voltage and full-load conditions unless otherwise noted.
- ② Ripple/Noise (R/N) measured over a 20MHz bandwidth.
- ③ 10% to 100% load.
- ④ Nominal line voltage, no-load/full-load conditions.
- ⑤ See Technical Notes for an explanation of trading off input voltage ranges for higher full-power operating temperature.
- ⑥ Please see the Part Number Structure for complete ordering options.

PART NUMBER STRUCTURE

U WR - 5 / 1800 - D48 A - C

Output Configuration:
U = Unipolar

Wide Range Input

Nominal Output Voltage:
5, 5.2, 12 or 15 Volts

Maximum Output Current
in mA

Note: Some model number combinations may not be available. Contact Murata Power Solutions for further information.

RoHS-6 hazardous substance compliant
A-Series
High Reliability

Input Voltage Range:
D5 = 4.7-7.25 Volts (5V nominal)
D12 = 9-18 Volts (12V nominal)
D24 = 18-36 Volts (24V nominal)
D48 = 18-75/36-72 Volts (48V nominal)

MECHANICAL SPECIFICATIONS

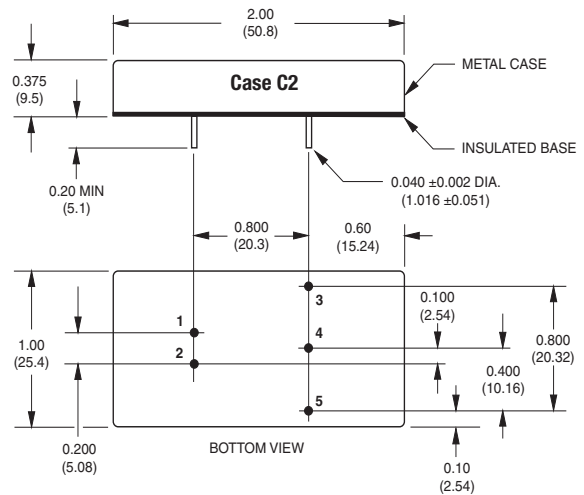

TEMPERATURE DERATING

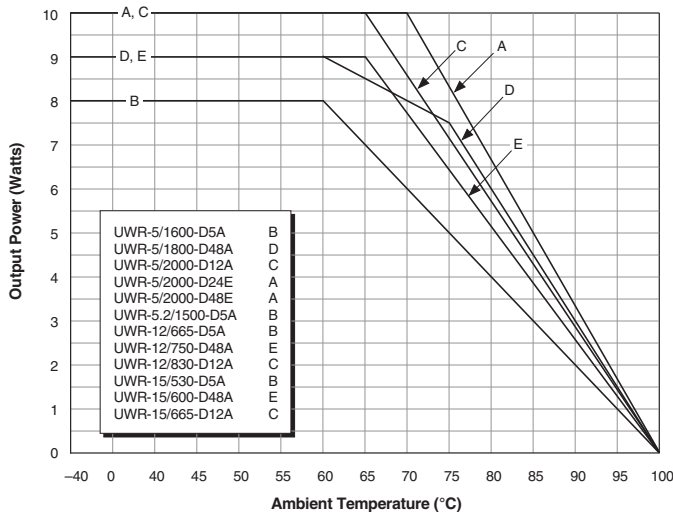

I/O Connections

Pin	Function P11
1	+Vin
2	-Vin
3	+Vout
4	No Pin
5	Common

Dimensions are in inches (mm) shown for ref. only.

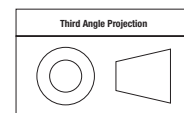

Tolerances (unless otherwise specified):
.XX ± 0.02 (0.5)
.XXX ± 0.010 (0.25)
Angles ± 2°

Components are shown for reference only.

Notes:

For "D5A, D12A and D24E" models, the case is connected to pin 2 (-Vin).

For "D48A and D48E" models, the case is connected to pin 1 (+Vin).

Performance/Functional Specifications

Typical @ T_A = +25°C under nominal line voltage and full-load conditions, unless noted. ①

Input	
Input Voltage Range:	
D5A Models	4.7-7.25 Volts (5V nominal)
D12A Models	9-18 Volts (12V nominal)
D24E Models	18-36Volts (24V nominal)
D48A Models	18-75 Volts (48V nominal)
D48E Models	36-72 Volts (48V nominal)
Input Current	See Ordering Guide
Input Filter Type ②	Pi
Overvoltage Shutdown:	
D5A Models	None
D12A Models	20 Volts
D24E Models	40 Volts
D48A and D48E Models	76 Volts
Reverse-Polarity Protection	Yes (Instantaneous, 6A maximum)
Output	
V_{out} Accuracy (50% load)	±1%, maximum
Temperature Coefficient	±0.02% per °C
Ripple/Noise (20MHz BW) ②	See Ordering Guide
Line/Load Regulation	See Ordering Guide
Efficiency	See Ordering Guide
Isolation Voltage ③	1500Vdc, guaranteed
Isolation Capacitance	250pF
Current Limiting	Auto-recovery
Overvoltage Protection ④	Zener/transorb clamp, magnetic feedback
Dynamic Characteristics	
Transient Response (50% load step)	200µsec max. to ±1.5% of final value
Switching Frequency	165kHz (±15kHz)
Flammability	UL94V-0
Environmental	
Operating Temperature (Ambient):	
Without Derating	-40 to +60/65/70°C (Model dependent)
With Derating	to +100°C (See Derating Curves)
Storage Temperature	-40 to +105°C
Physical	
Dimensions	2" x 1" x 0.375" (51 x 25 x 9.5mm)
Shielding	5-sided
Case Connection:	
D5A, D12A and D24E Models	Pin 2 (-V _{IN})
D48A and D48E Models	Pin 1 (+V _{IN})
Case Material	Corrosion resistant steel with non-conductive, epoxy-based, black enamel finish and plastic baseplate
Pin Material	Gold plate over copper alloy
Weight	1.3 ounces (37 grams)

① These power converters require a minimum 10% loading to maintain specified regulation. Operation under no-load conditions will not damage these devices; however they may not meet all listed specifications.

② Application-specific input/output filtering can be recommended and perhaps added internally upon request for scheduled, quantity orders. Contact DATEL Applications Engineering for details.

③ Devices can be screened or modified for higher guaranteed isolation voltages. Contact DATEL Applications Engineering for details.

④ Except for 3.3V devices which have no protection.

Absolute Maximum Ratings

Input Voltage:	
D5A Models	10 Volts
D12A Models	22 Volts
D24E Models	44 Volts
D48A and D48E Models	80 Volts
Input Reverse-Polarity Protection	Current must be <6A. Brief duration only. Fusing recommended.
Output Overvoltage Protection	
5/5.2V Outputs	6.8 Volts, limited duration
12V Outputs	15 Volts, limited duration
15V Outputs	18 Volts, limited duration
Output Current	Current limited. Max. current and short-circuit duration model dependent.
Storage Temperature	-40 to +105°C

These are stress ratings. Exposure of devices to greater than any of these conditions may adversely affect long-term reliability. Proper operation under conditions other than those listed in the Performance/Functional Specifications Table is not implied.

TECHNICAL NOTES

Floating Outputs

Since these are isolated DC/DC converters, their outputs are "floating." Designers will usually use the output Common (pin 5) as the ground/return of the load circuit. You can, however, use the +Output (pin 3) as ground/return to effectively reverse the output polarity.

Filtering and Noise Reduction

All A-Series UWR 6-10 Watt DC/DC Converters achieve their rated ripple and noise specifications without the use of external input/output capacitors. In critical applications, input/output ripple and noise may be further reduced by installing electrolytic capacitors across the input terminals and/or low-ESR tantalum or electrolytic capacitors across the output terminals. The caps should be located as close to the power converters as possible. Typical values are listed in the tables below. In many applications, using values greater than those listed will yield better results.

To Reduce Input Ripple

D5A Models	47µF, 10V
D12A and D24E Models	20µF, 50V
D48A and D48E Models	10µF, 100V

To Reduce Output Ripple

5/5.2V Outputs	47µF, 10V, Low ESR
12/15V Outputs	22µF, 20V, Low ESR

In critical, space-sensitive applications, DATEL may be able to tailor the internal input/output filtering of these units to meet your specific requirements.

Typical Performance Curves ($T_A = +25^\circ\text{C}$)

The performance curves below were derived from actual test data for a single model number (UWR-5/1800-D48A). Since all devices in the 6-10W UWR A-Series have the same circuit topology, the performance curves are representative of all devices.

LINE REGULATION

Output Voltage vs. Input Voltage and Output Current

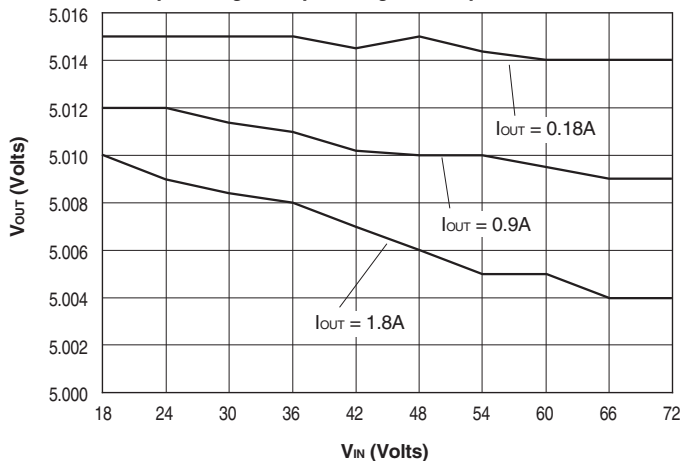

LOAD REGULATION

Output Voltage vs. Output Current and Input Voltage

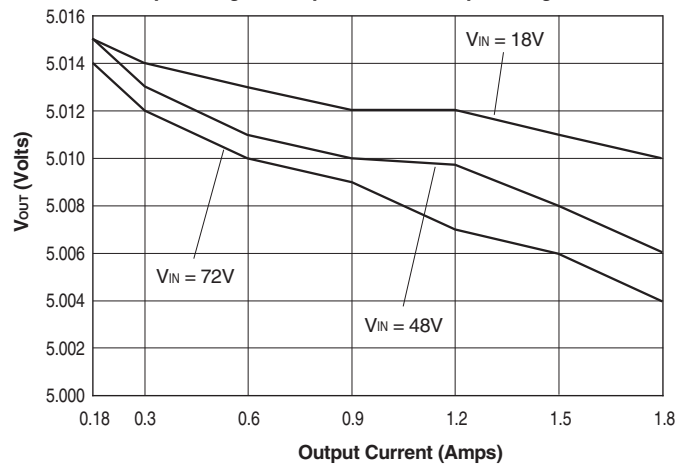

EFFICIENCY

Efficiency vs. Output Current and Input Voltage

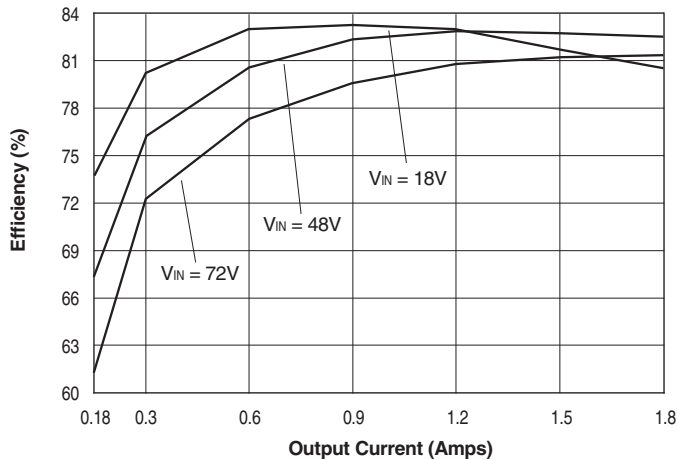

Input Fusing

Certain applications and/or safety agencies may require the installation of fuses at the inputs of power conversion components. For DATEL A-Series UWR 6-10 Watt DC/DC Converters, you should use slow-blow type fuses with values no greater than the following:

V _{IN} Range	Fuse Value
D5A	3A
D12A and D24E	2A
D48A and D48E	1A

EMI RADIATED EMISSIONS

If you're designing with EMC in mind, please note that all of DATEL's A-Series UWR 6-10 Watt DC/DC Converters have been characterized for radiated and conducted emissions in our new EMI/EMC laboratory. Testing is conducted in an EMCO 5305 GTEM test cell utilizing EMCO automated EMC test software. Radiated emissions are tested to the limits of FCC Part 15, Class B and CISPR 22 (EN 55022), Class B. Radiated emissions plots to FCC and CISPR 22 for model UWR-12/665-D5A appear below.

**UWR-12/665-D5A Radiated Emissions
FCC Part 15 Class B, 3 Meters
Converter Output = 12Vdc @ 620mA**

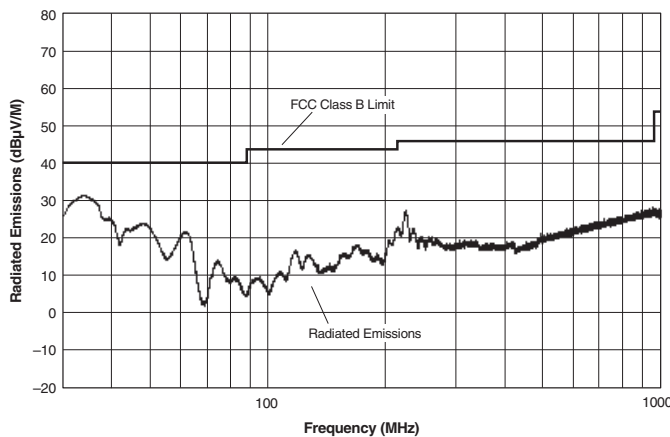

**UWR-12/665-D5A Radiated Emissions
EN 55022 Class B, 10 Meters
Converter Output = 12Vdc @ 620mA**

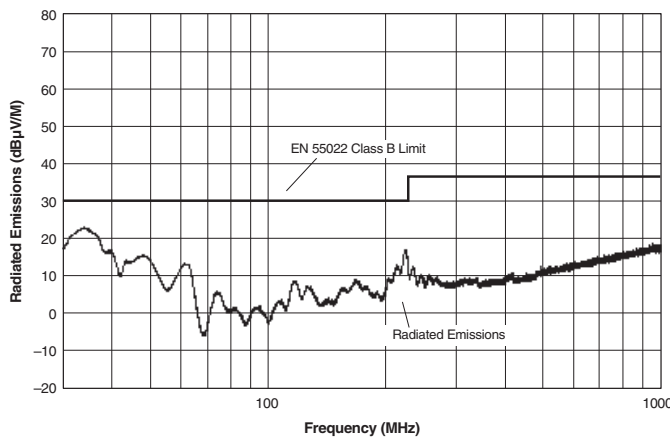

CUSTOM CAPABILITIES

DATEL's world-class design, development and manufacturing team stands ready to work with you to deliver the exact power converter you need for your demanding, large volume, OEM applications. And ... we'll do it on time and within budget!

Our experienced applications and design staffs; quick-turn prototype capability; highly automated, SMT assembly facilities; and in-line SPC quality-control techniques combine to give us the unique ability to design and deliver any quantity of power converters to the highest standards of quality and reliability.

We have compiled a large library of DC/DC designs that are currently used in a variety of telecom, medical, computer, railway, aerospace and industrial applications. We may already have the converter you need.

Contact us. Our goal is to provide you the highest-quality, most cost-effective power converters available.

Quality and Reliability

The A-Series are the first DC/DC Converters to emerge from DATEL's new, company-wide approach to designing and manufacturing the most reliable power converters available. The five-pronged program draws our Quality Assurance function into all aspects of new-product design, development, characterization, qualification and manufacturing.

Design for Reliability

Design for Reliability is woven throughout our multi-phased, new-product-development process. Design-for-reliability practices are fully documented and begin early in the new-product development cycle with the following goals:

1. To work from an approved components/vendors list ensuring the use of reliable components and the rigorous qualification of new components.
2. To design with safety margins by adhering to a strict set of derating guidelines and performing theoretical worst-case analyses.
3. To locate potential design weaknesses early in the product-development cycle by using extensive HALT (Highly Accelerated Life Testing).
4. To prove that early design improvements are effective by employing a thorough FRACA (Failure Reporting Analysis and Corrective Action) System.

Soldering Guidelines

Murata Power Solutions recommends the specifications below when installing these converters. These specifications vary depending on the solder type. Exceeding these specifications may cause damage to the product. Be cautious when there is high atmospheric humidity. We strongly recommend a mild pre-bake (100° C. for 30 minutes). Your production environment may differ; therefore please thoroughly review these guidelines with your process engineers.

Wave Solder Operations for through-hole mounted products (THMT)

For Sn/Ag/Cu based solders:

Maximum Preheat Temperature	115° C.
Maximum Pot Temperature	270° C.
Maximum Solder Dwell Time	7 seconds

For Sn/Pb based solders:

Maximum Preheat Temperature	105° C.
Maximum Pot Temperature	250° C.
Maximum Solder Dwell Time	6 seconds

HALT Testing

The goal of the accelerated-stress techniques used by DATEL is to force device maturity, in a short period of time, by exposing devices to excessive levels of "every stimulus of potential value." We use HALT (Highly Accelerated Life Testing) repeatedly during the design and early manufacturing phases to detect potential electrical and mechanical design weaknesses that could result in possible future field failures.

During HALT, prototype and pre-production DC/DC converters are subjected to progressively higher stress levels induced by thermal cycling, rate of temperature change, vibration, power cycling, product-specific stresses (such as dc voltage variation) and combined environments. The stresses are not meant to simulate field environments but to expose any weaknesses in a product's electro/mechanical design and/or assembly processes. The goal of HALT is to make products fail so that device weaknesses can be analyzed and strengthened as appropriate. Applied stresses are continually stepped up until products eventually fail. After corrective actions and/or design changes, stresses are stepped up again and the cycle is repeated until the "fundamental limit of the technology" is determined.

DATEL has invested in a Qualmark OVS-1 HALT tester capable of applying voltage and temperature extremes as well as 6-axis, linear and rotational, random vibration. A typical HALT profile (shown above) consists of thermal cycling (-55 to +125°C, 30°C/minute) and simultaneous, gradually increasing, random longitudinal and rotational vibration up to 20G's with load cycling and applied-voltage extremes added as desired. Many devices in DATEL's new A-Series could not be made to fail prior to reaching either the limits of the HALT chamber or some previously known physical limit of the device.

We also use the HALT chamber and its ability to rapidly cool devices to verify their "cold-start" capabilities.

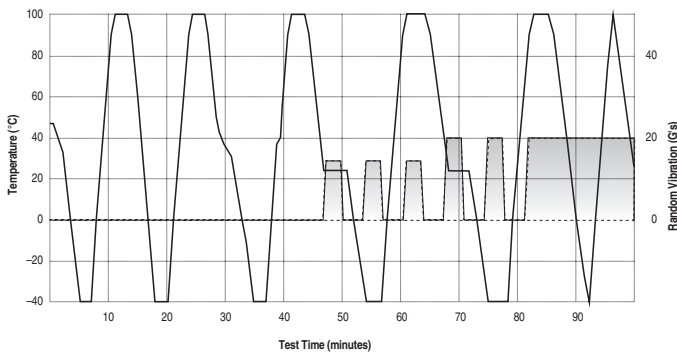

Typical HALT Profile

Qualification

For each new product, electrical performance is verified via a comprehensive characterization process and long-term reliability is confirmed via a rigorous qualification procedure. The qual procedure includes such strenuous tests as thermal shock and 500 hour life. Qual testing is summarized below.

Qualification Testing

Qualification Test	Method/Comments
HALT	DATEL in-house procedure
High Temperature Storage	Max. rated temp., 1,000 hours
Thermal Shock	10 cycles, -55 to +125°C
Temperature/Humidity	+85°C, 85% humidity, 48 hours
Lead Integrity	DATEL in-house procedure
Life Test	+70°C, 500 hours*
Marking Permanency	DATEL in-house procedure
End Point Electrical Tests	Per product specification

* Interim electrical test at 200 hours.

In-Line Process Controls and Screening

A combination of statistical sampling and 100% inspection techniques keeps our assembly line under constant control. Parameters such as solder-paste thickness, component placement, cleanliness, etc. are statistically sampled, charted and fine tuned as necessary. Visual inspections are performed by trained operators after pick-and-place, soldering and cleaning operations. Units are 100% electrically tested prior to potting. All devices are temperature cycled, burned-in, hi-pot tested and final-electrical tested prior to external visual examination, packing and shipping.

Rapid Response to Problems

DATEL employs an outstanding corrective-action system to immediately address any detected shortcomings in either products or processes. Whenever our assembly, quality or engineering personnel spot a product/process problem, or if a product is returned with a potential defect, we immediately perform a detailed failure analysis and, if necessary, undertake corrective actions. Over time, this system has helped refine our assembly operation to yield one of the lowest product defect rates in the industry.

Murata Power Solutions, Inc.
11 Cabot Boulevard, Mansfield, MA 02048-1151 U.S.A.
ISO 9001 and 14001 REGISTERED



This product is subject to the following [operating requirements](http://www.murata-ps.com/requirements/) and the [Life and Safety Critical Application Sales Policy](#): Refer to: <http://www.murata-ps.com/requirements/>

Murata Power Solutions, Inc. makes no representation that the use of its products in the circuits described herein, or the use of other technical information contained herein, will not infringe upon existing or future patent rights. The descriptions contained herein do not imply the granting of licenses to make, use, or sell equipment constructed in accordance therewith. Specifications are subject to change without notice. © 2012 Murata Power Solutions, Inc.

Компания «Океан Электроники» предлагает заключение долгосрочных отношений при поставках импортных электронных компонентов на взаимовыгодных условиях!

Наши преимущества:

- Поставка оригинальных импортных электронных компонентов напрямую с производств Америки, Европы и Азии, а так же с крупнейших складов мира;
- Широкая линейка поставок активных и пассивных импортных электронных компонентов (более 30 млн. наименований);
- Поставка сложных, дефицитных, либо снятых с производства позиций;
- Оперативные сроки поставки под заказ (от 5 рабочих дней);
- Экспресс доставка в любую точку России;
- Помощь Конструкторского Отдела и консультации квалифицированных инженеров;
- Техническая поддержка проекта, помощь в подборе аналогов, поставка прототипов;
- Поставка электронных компонентов под контролем ВП;
- Система менеджмента качества сертифицирована по Международному стандарту ISO 9001;
- При необходимости вся продукция военного и аэрокосмического назначения проходит испытания и сертификацию в лаборатории (по согласованию с заказчиком);
- Поставка специализированных компонентов военного и аэрокосмического уровня качества (Xilinx, Altera, Analog Devices, Intersil, Interpoint, Microsemi, Actel, Aeroflex, Peregrine, VPT, Syfer, Eurofarad, Texas Instruments, MS Kennedy, Miteq, Cobham, E2V, MA-COM, Hittite, Mini-Circuits, General Dynamics и др.);

Компания «Океан Электроники» является официальным дистрибьютором и эксклюзивным представителем в России одного из крупнейших производителей разъемов военного и аэрокосмического назначения «JONHON», а так же официальным дистрибьютором и эксклюзивным представителем в России производителя высокотехнологичных и надежных решений для передачи СВЧ сигналов «FORSTAR».



JONHON

«JONHON» (основан в 1970 г.)

Разъемы специального, военного и аэрокосмического назначения:

(Применяются в военной, авиационной, аэрокосмической, морской, железнодорожной, горно- и нефтедобывающей отраслях промышленности)

«FORSTAR» (основан в 1998 г.)

ВЧ соединители, коаксиальные кабели, кабельные сборки и микроволновые компоненты:

(Применяются в телекоммуникациях гражданского и специального назначения, в средствах связи, РЛС, а так же военной, авиационной и аэрокосмической отраслях промышленности).



Телефон: 8 (812) 309-75-97 (многоканальный)

Факс: 8 (812) 320-03-32

Электронная почта: ocean@oceanchips.ru

Web: <http://oceanchips.ru/>

Адрес: 198099, г. Санкт-Петербург, ул. Калинина, д. 2, корп. 4, лит. А