



SANYO Semiconductors

# DATA SHEET

An ON Semiconductor Company

## 2SB1202/2SD1802 — PNP/NPN Epitaxial Planar Silicon Transistor

### High-Current Switching Applications

#### Applications

- Voltage regulators, relay drivers, lamp drivers, electrical equipment

#### Features

- Adoption of FBET and MBIT processes
- Low collector-to-emitter saturation voltage
- Small and slim package making it easy to make 2SB1202/2SD1802-used sets smaller
- Large current capacitance and wide ASO
- Fast switching speed

#### Specifications ( ) : 2SB1202

Absolute Maximum Ratings at Ta=25°C

Parameter	Symbol	Conditions	Ratings	Unit
Collector-to-Base Voltage	V <sub>CB0</sub>		(-)60	V
Collector-to-Emitter Voltage	V <sub>CE0</sub>		(-)50	V
Emitter-to-Base Voltage	V <sub>EB0</sub>		(-)6	V
Collector Current	I <sub>C</sub>		(-)5	A
Collector Current (Pulse)	I <sub>CP</sub>		(-)6	A

Continued on next page.

#### Package Dimensions unit : mm (typ)

7518-003

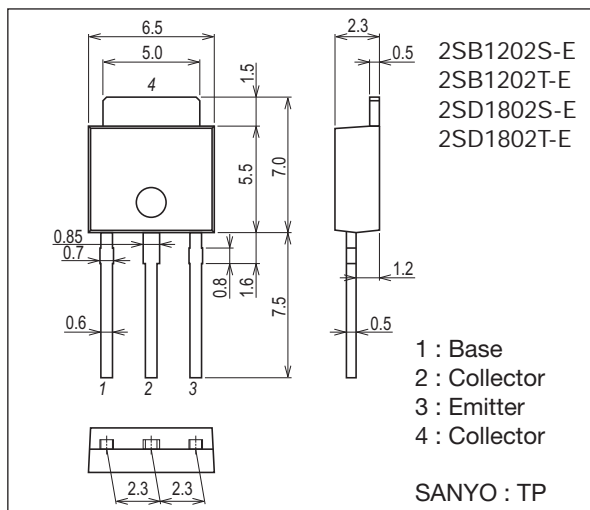

#### Package Dimensions unit : mm (typ)

7003-003

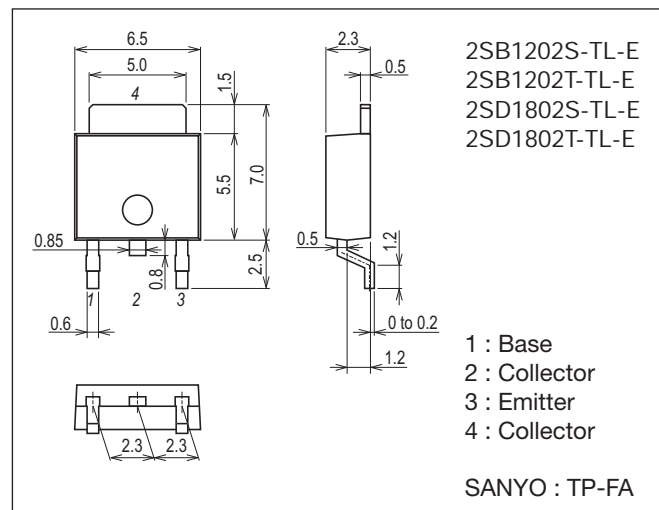

#### Product & Package Information

- Package : TP
- JEITA, JEDEC : SSC-64, TO-251
- Minimum Packing Quantity : 500 pcs./bag

#### Marking (TP, TP-FA)

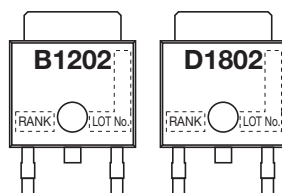

- Package : TP-FA
- JEITA, JEDEC : SSC-63, TO-252
- Minimum Packing Quantity : 700 pcs./reel

#### Packing Type (TP-FA) : TL Electrical Connection

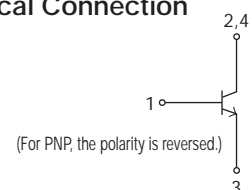
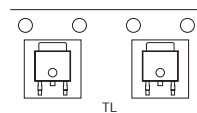

SANYO Semiconductor Co., Ltd.

<http://www.sanyosemi.com/en/network/>

## 2SB1202/2SD1802

Continued from preceding page.

Parameter	Symbol	Conditions	Ratings	Unit
Collector Dissipation	P <sub>C</sub>		1	W
		T <sub>C</sub> =25°C	15	W
Junction Temperature	T <sub>J</sub>		150	°C
Storage Temperature	T <sub>stg</sub>		-55 to +150	°C

### Electrical Characteristics at T<sub>a</sub>=25°C

Parameter	Symbol	Conditions	Ratings			Unit	
			min	typ	max		
Collector Cutoff Current	I <sub>CBO</sub>	V <sub>CB</sub> =(-)40V, I <sub>E</sub> =0A			(-)1	μA	
Emitter Cutoff Current	I <sub>EBO</sub>	V <sub>EB</sub> =(-)4V, I <sub>C</sub> =0A			(-)1	μA	
DC Current Gain	h <sub>FE1</sub>	V <sub>CE</sub> =(-)2V, I <sub>C</sub> =(-)100mA	100*		560*		
	h <sub>FE2</sub>	V <sub>CE</sub> =(-)2V, I <sub>C</sub> =(-)3A	35				
Gain-Bandwidth Product	f <sub>T</sub>	V <sub>CE</sub> =(-)10V, I <sub>C</sub> =(-)50mA		150		MHz	
Output Capacitance	C <sub>ob</sub>	V <sub>CB</sub> =(-)10V, f=1MHz		(39)25		pF	
Collector-to-Emitter Saturation Voltage	V <sub>CE(sat)</sub>	I <sub>C</sub> =(-)2A, I <sub>B</sub> =(-)100mA		(-0.35)0.19	(-0.7)0.5	mV	
Base-to-Emitter Saturation Voltage	V <sub>BE(sat)</sub>	V <sub>CE</sub> =(-)2V, I <sub>C</sub> =(-)100mA		(-)0.94	(-)1.2	V	
Collector-to-Base Breakdown Voltage	V(BR)CBO	I <sub>C</sub> =(-)10μA, I <sub>E</sub> =0A	(-)60			V	
Collector-to-Emitter Breakdown Voltage	V(BR)CEO	I <sub>C</sub> =(-)1mA, R <sub>BE</sub> =∞	(-)50			V	
Emitter-to-Base Breakdown Voltage	V(BR)EBO	I <sub>E</sub> =(-)10μA, I <sub>C</sub> =0A	(-)6			V	
Turn-On Time	t <sub>on</sub>	See specified Test Circuit.		70		ns	
Storage Time	t <sub>stg</sub>			(450)650			ns
Fall Time	t <sub>f</sub>			35			ns

\* : The 2SB1202/2SD1802 are classified by 100mA h<sub>FE</sub> as follows :

Rank	R	S	T	U
h <sub>FE</sub>	100 to 200	140 to 280	200 to 400	280 to 560

### Switching Time Test Circuit

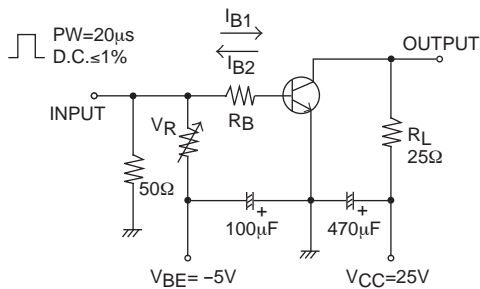

$$I_C = 10I_{B1} = -10I_{B2} = 1A$$

For PNP, the polarity is reversed.

### Ordering Information

Device	Package	Shipping	memo
2SB1202S-E	TP	500pcs./bag	Pb Free
2SB1202T-E	TP	500pcs./bag	
2SD1802S-E	TP	500pcs./bag	
2SD1802T-E	TP	500pcs./bag	
2SB1202S-TL-E	TP-FA	700pcs./reel	
2SB1202T-TL-E	TP-FA	700pcs./reel	
2SD1802S-TL-E	TP-FA	700pcs./reel	
2SD1802T-TL-E	TP-FA	700pcs./reel	

2SB1202/2SD1802

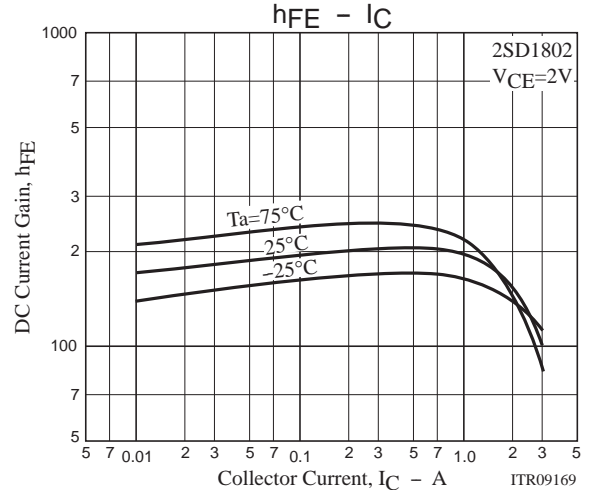
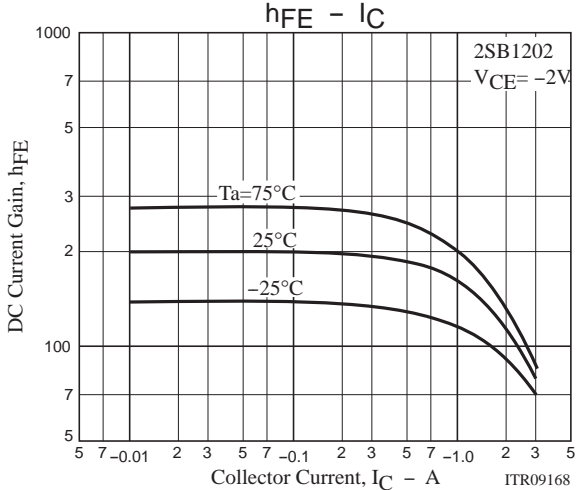
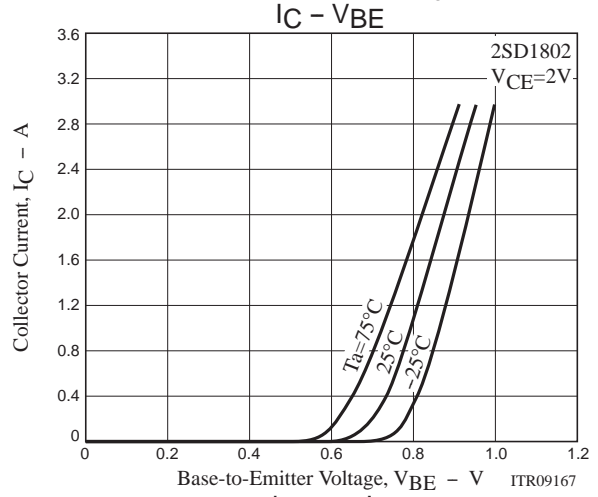
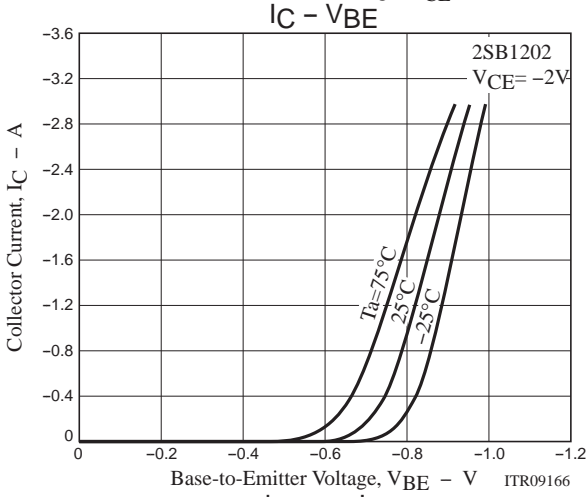
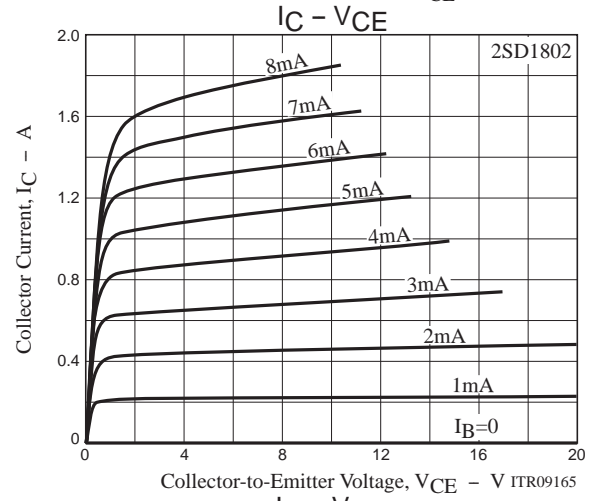
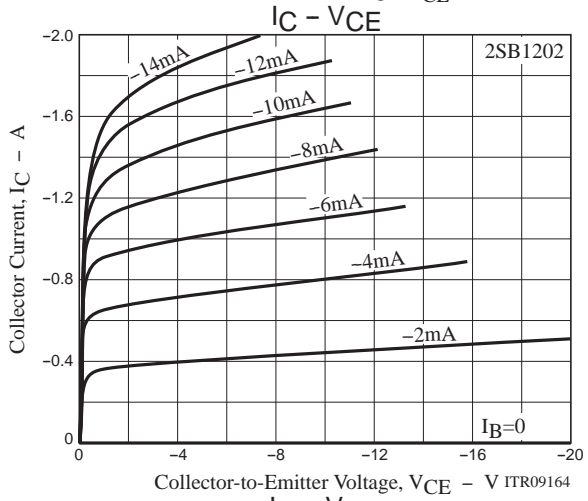
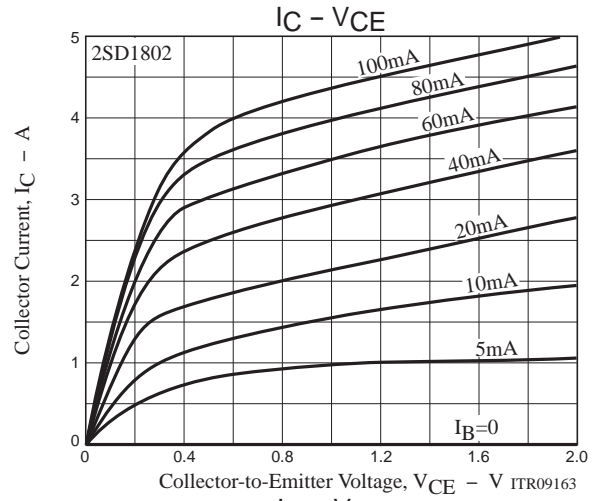
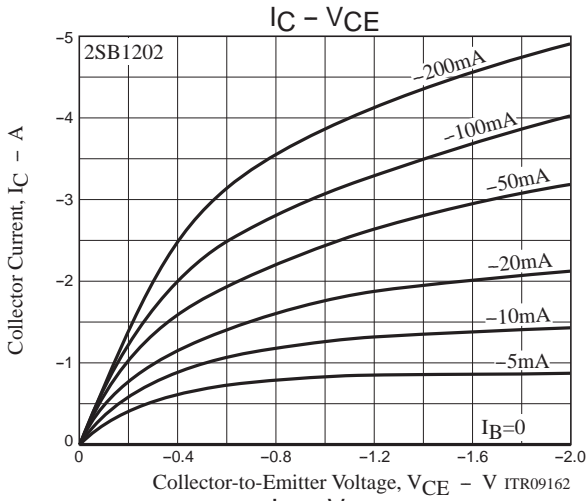

2SB1202/2SD1802

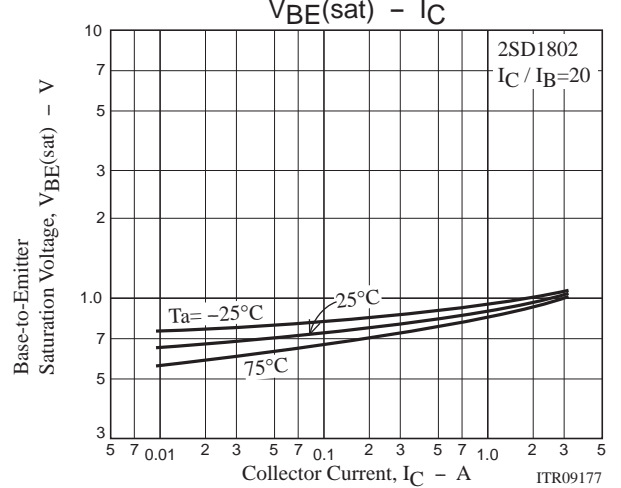
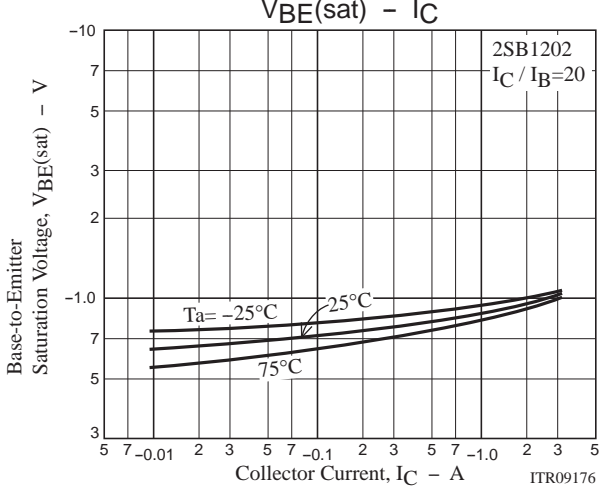
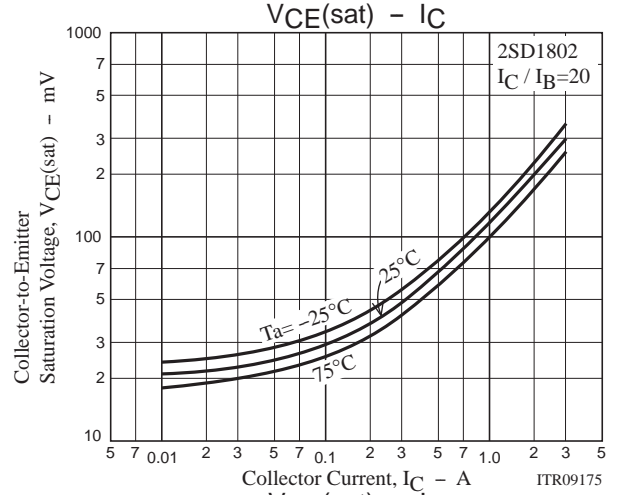
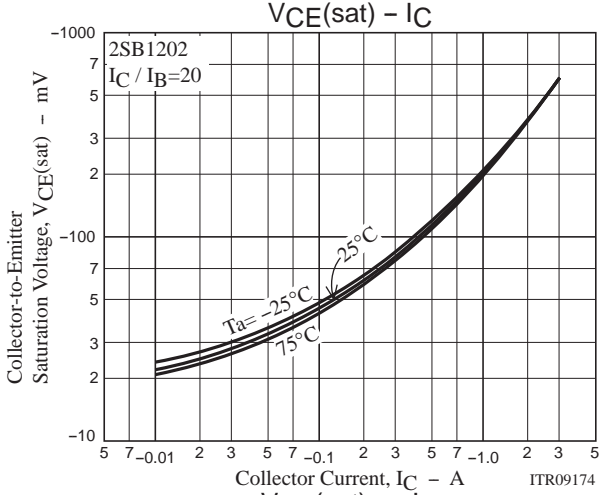
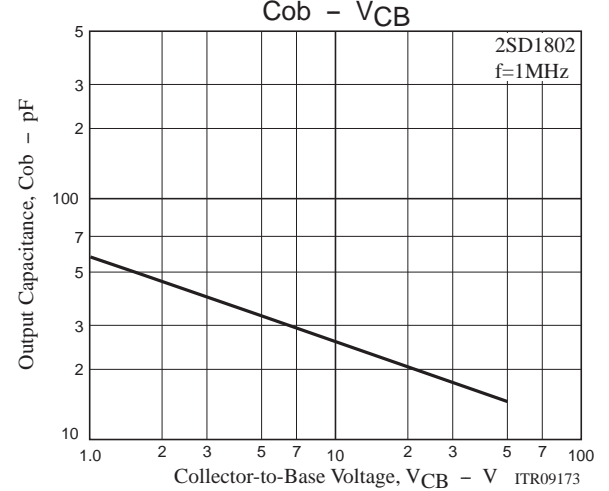
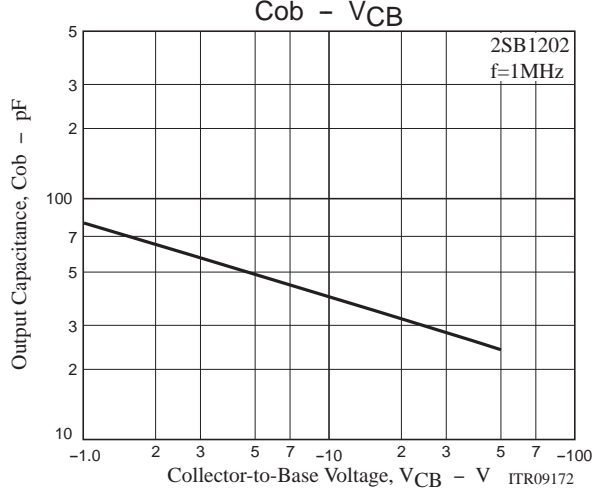
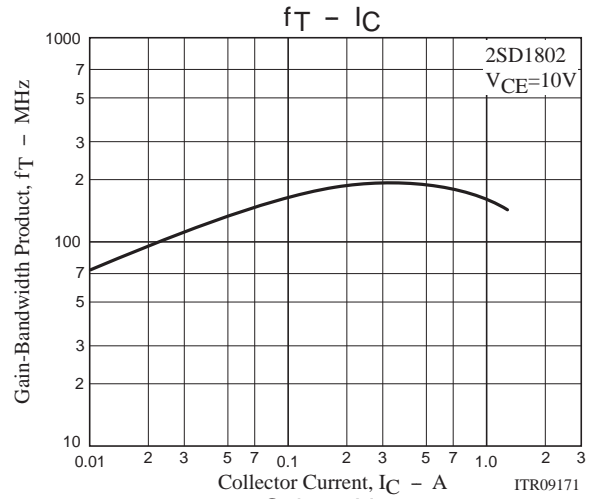
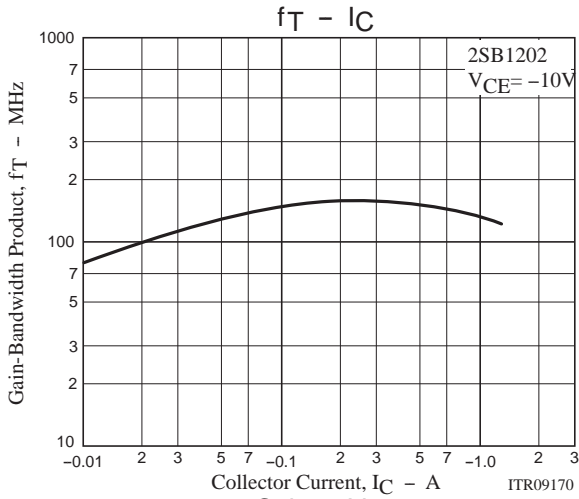

# 2SB1202/2SD1802

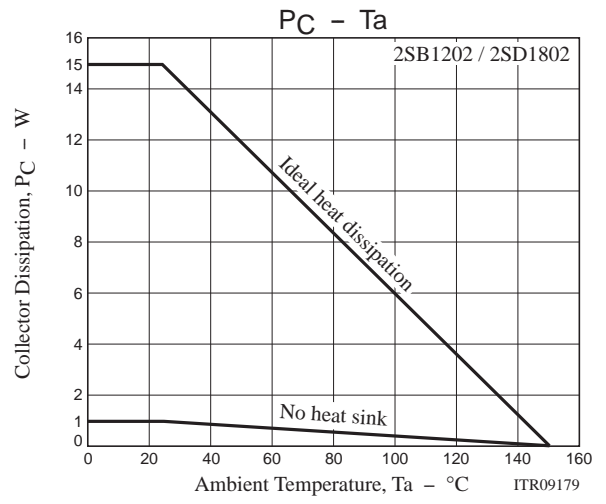
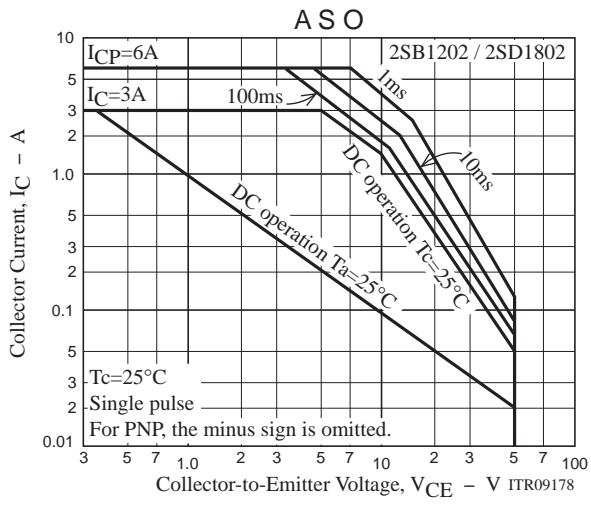

# 2SB1202/2SD1802

## Taping Specification

2SB1202S-TL-E, 2SB1202T-TL-E, 2SD1802S-TL-E, 2SD1802T-TL-E

### Packing Format

Package Name	Carrier Tape Type	Maximum Number of devices contained (pcs)			Packing format	
		Reel	Inner box	Outer box	Inner BOX (C-1)	Outer BOX (A-7)
TP-FA	TP	700	2,100	12,600	3 reels contained Dimensions:mm (external) 183×72×185	6 inner boxes contained Dimensions:mm (external) 440×195×210

Reel label, Inner box label  
(unit:mm)

Outer box label

It is a label at the time of factory shipments.  
The form of a label may change in physical distribution process.

### Packing method

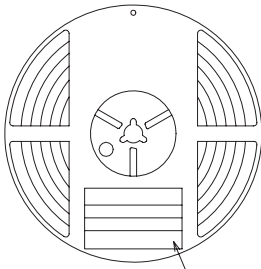

Type No.  
LOT No.  
Quantity  
Origin

Reel label

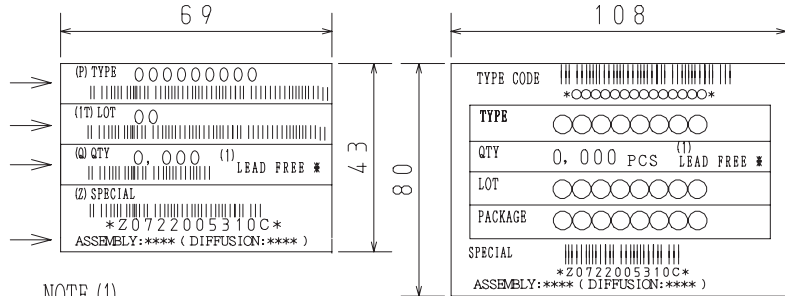

NOTE (1)

The LEAD FREE \* description shows that the surface treatment of the terminal is lead free.

Label	JEITA Phase
LEAD FREE 3	JEITA Phase 3A
LEAD FREE 4	JEITA Phase 3

### Taping configuration

#### 1. Carrier tape size (unit:mm)

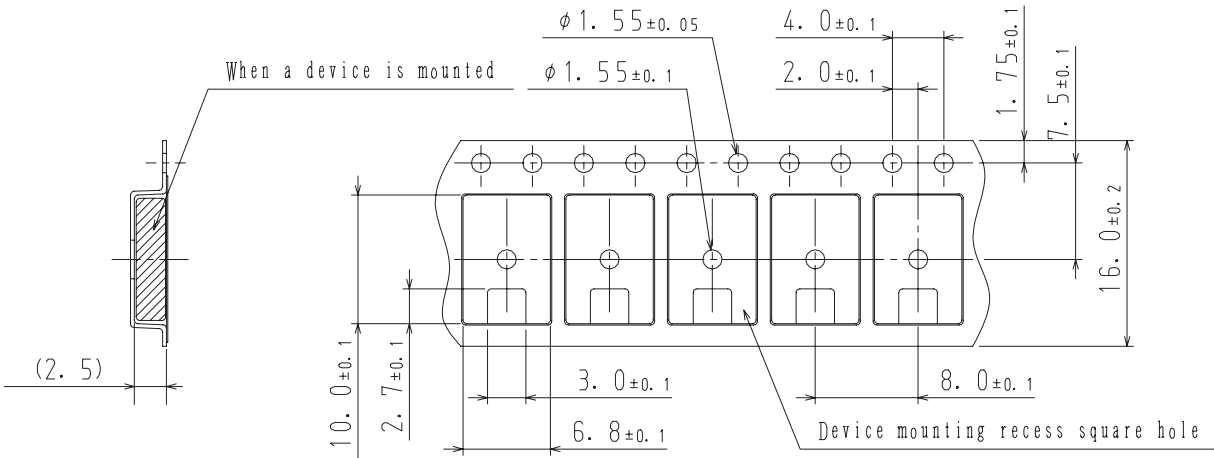

#### 2. Device placement direction

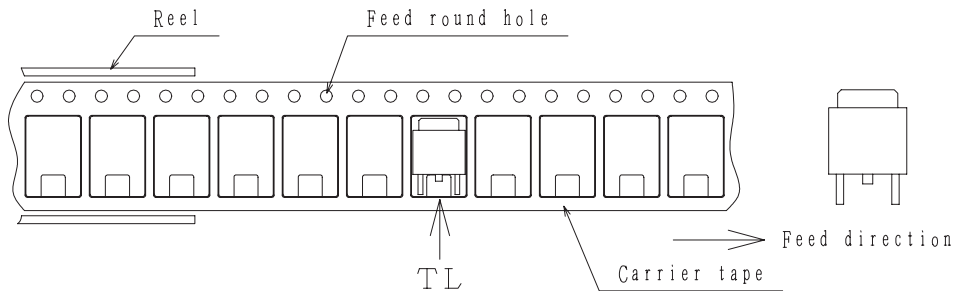

Those with one electrode terminal on the feed hole side.....TL

# 2SB1202/2SD1802

## Outline Drawing

## Land Pattern Example

2SB1202S-TL-E, 2SB1202T-TL-E, 2SD1802S-TL-E, 2SD1802T-TL-E

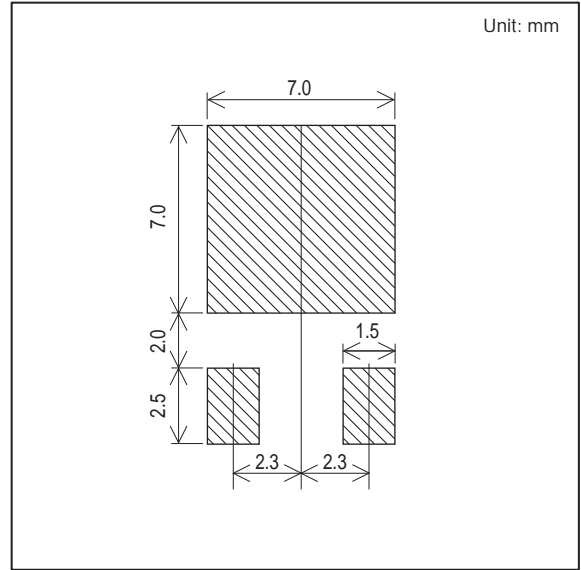
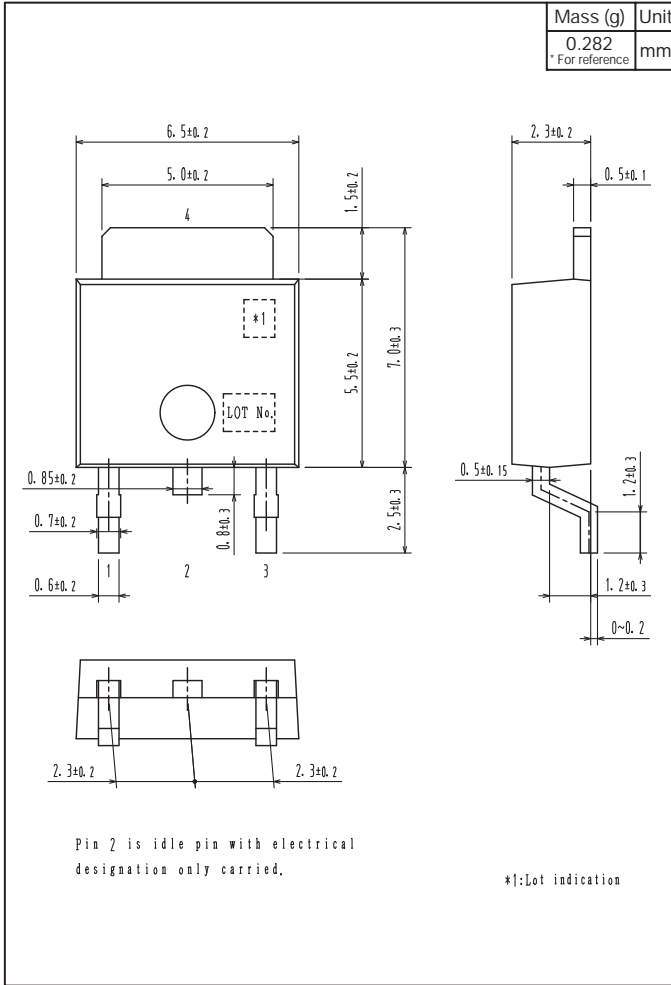

# 2SB1202/2SD1802

## Bag Packing Specification

2SB1202S-E, 2SB1202T-E, 2SD1802S-E, 2SD1802T-E

### 1. Packing Format

Package Name	Maximum Number of devices contained (pcs)			
	Bag	Inner box	Outer box	
TP	500	B-1	A-1	A-2
		10,000	50,000	30,000
	Packing format (Dimensions:mm (external))			
		Inner box	Outer box	
		B-1	A-1	A-2
		445×225×55	470×250×300	470×250×190

### 2. Bag dimensions (unit:mm)

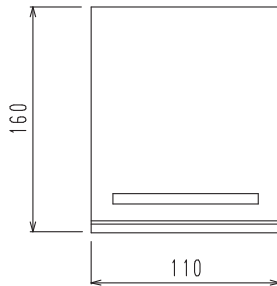

### 3. Bag label, Inner box label (unit:mm)

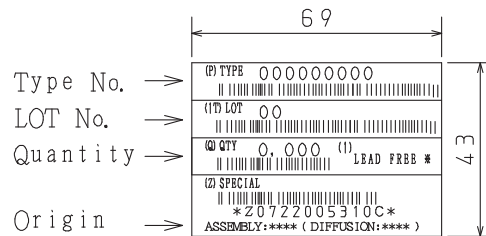

### 4. Outer box label (unit:mm)

It is a label at the time of factory shipments.  
The form of a label may change in physical  
distribution process.

**NOTE (1)**

The LEAD FREE \* description shows that the  
surface treatment of the terminal is lead free.

Label	JEITA Phase
LEAD FREE 3	JEITA Phase 3A
LEAD FREE 4	JEITA Phase 3

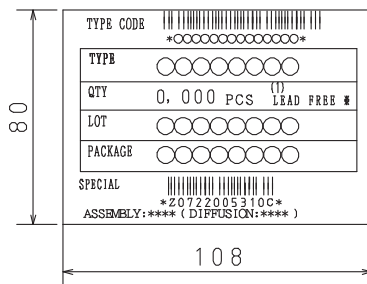



# 2SB1202/2SD1802

## Outline Drawing

2SB1202S-E, 2SB1202T-E, 2SD1802S-E, 2SD1802T-E

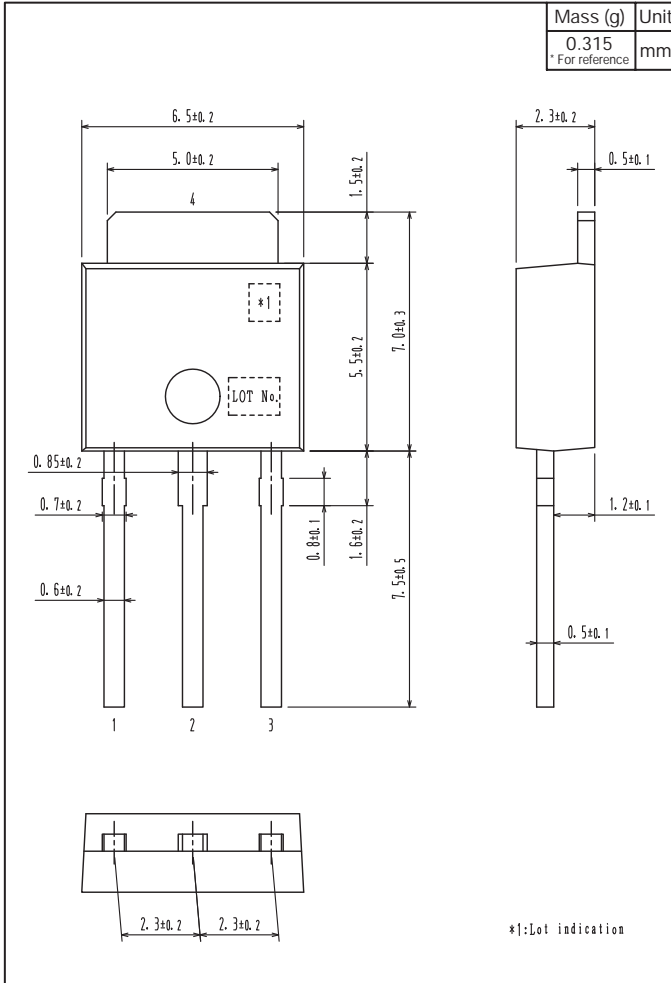

- Any and all SANYO Semiconductor Co.,Ltd. products described or contained herein are, with regard to "standard application", intended for the use as general electronics equipment. The products mentioned herein shall not be intended for use for any "special application" (medical equipment whose purpose is to sustain life, aerospace instrument, nuclear control device, burning appliances, transportation machine, traffic signal system, safety equipment etc.) that shall require extremely high level of reliability and can directly threaten human lives in case of failure or malfunction of the product or may cause harm to human bodies, nor shall they grant any guarantee thereof. If you should intend to use our products for new introduction or other application different from current conditions on the usage of automotive device, communication device, office equipment, industrial equipment etc. , please consult with us about usage condition (temperature, operation time etc.) prior to the intended use. If there is no consultation or inquiry before the intended use, our customer shall be solely responsible for the use.
- Specifications of any and all SANYO Semiconductor Co.,Ltd. products described or contained herein stipulate the performance, characteristics, and functions of the described products in the independent state, and are not guarantees of the performance, characteristics, and functions of the described products as mounted in the customer's products or equipment. To verify symptoms and states that cannot be evaluated in an independent device, the customer should always evaluate and test devices mounted in the customer's products or equipment.
- SANYO Semiconductor Co.,Ltd. assumes no responsibility for equipment failures that result from using products at values that exceed, even momentarily, rated values (such as maximum ratings, operating condition ranges, or other parameters) listed in products specifications of any and all SANYO Semiconductor Co.,Ltd. products described or contained herein.
- Regarding monolithic semiconductors, if you should intend to use this IC continuously under high temperature, high current, high voltage, or drastic temperature change, even if it is used within the range of absolute maximum ratings or operating conditions, there is a possibility of decrease reliability. Please contact us for a confirmation.
- SANYO Semiconductor Co.,Ltd. strives to supply high-quality high-reliability products, however, any and all semiconductor products fail or malfunction with some probability. It is possible that these probabilistic failures or malfunction could give rise to accidents or events that could endanger human lives, trouble that could give rise to smoke or fire, or accidents that could cause damage to other property. When designing equipment, adopt safety measures so that these kinds of accidents or events cannot occur. Such measures include but are not limited to protective circuits and error prevention circuits for safe design, redundant design, and structural design.
- In the event that any or all SANYO Semiconductor Co.,Ltd. products described or contained herein are controlled under any of applicable local export control laws and regulations, such products may require the export license from the authorities concerned in accordance with the above law.
- No part of this publication may be reproduced or transmitted in any form or by any means, electronic or mechanical, including photocopying and recording, or any information storage or retrieval system, or otherwise, without the prior written consent of SANYO Semiconductor Co.,Ltd.
- Any and all information described or contained herein are subject to change without notice due to product/technology improvement, etc. When designing equipment, refer to the "Delivery Specification" for the SANYO Semiconductor Co.,Ltd. product that you intend to use.
- Upon using the technical information or products described herein, neither warranty nor license shall be granted with regard to intellectual property rights or any other rights of SANYO Semiconductor Co.,Ltd. or any third party. SANYO Semiconductor Co.,Ltd. shall not be liable for any claim or suits with regard to a third party's intellectual property rights which has resulted from the use of the technical information and products mentioned above.

This catalog provides information as of August, 2012. Specifications and information herein are subject to change without notice.

Компания «Океан Электроники» предлагает заключение долгосрочных отношений при поставках импортных электронных компонентов на взаимовыгодных условиях!

Наши преимущества:

- Поставка оригинальных импортных электронных компонентов напрямую с производств Америки, Европы и Азии, а так же с крупнейших складов мира;
- Широкая линейка поставок активных и пассивных импортных электронных компонентов (более 30 млн. наименований);
- Поставка сложных, дефицитных, либо снятых с производства позиций;
- Оперативные сроки поставки под заказ (от 5 рабочих дней);
- Экспресс доставка в любую точку России;
- Помощь Конструкторского Отдела и консультации квалифицированных инженеров;
- Техническая поддержка проекта, помощь в подборе аналогов, поставка прототипов;
- Поставка электронных компонентов под контролем ВП;
- Система менеджмента качества сертифицирована по Международному стандарту ISO 9001;
- При необходимости вся продукция военного и аэрокосмического назначения проходит испытания и сертификацию в лаборатории (по согласованию с заказчиком);
- Поставка специализированных компонентов военного и аэрокосмического уровня качества (Xilinx, Altera, Analog Devices, Intersil, Interpoint, Microsemi, Actel, Aeroflex, Peregrine, VPT, Syfer, Eurofarad, Texas Instruments, MS Kennedy, Miteq, Cobham, E2V, MA-COM, Hittite, Mini-Circuits, General Dynamics и др.);

Компания «Океан Электроники» является официальным дистрибьютором и эксклюзивным представителем в России одного из крупнейших производителей разъемов военного и аэрокосмического назначения «JONHON», а так же официальным дистрибьютором и эксклюзивным представителем в России производителя высокотехнологичных и надежных решений для передачи СВЧ сигналов «FORSTAR».



## JONHON

«JONHON» (основан в 1970 г.)

Разъемы специального, военного и аэрокосмического назначения:

(Применяются в военной, авиационной, аэрокосмической, морской, железнодорожной, горно- и нефтедобывающей отраслях промышленности)

«FORSTAR» (основан в 1998 г.)

ВЧ соединители, коаксиальные кабели, кабельные сборки и микроволновые компоненты:

(Применяются в телекоммуникациях гражданского и специального назначения, в средствах связи, РЛС, а так же военной, авиационной и аэрокосмической отраслях промышленности).



Телефон: 8 (812) 309-75-97 (многоканальный)

Факс: 8 (812) 320-03-32

Электронная почта: [ocean@oceanchips.ru](mailto:ocean@oceanchips.ru)

Web: <http://oceanchips.ru/>

Адрес: 198099, г. Санкт-Петербург, ул. Калинина, д. 2, корп. 4, лит. А