



Low profile:
15.7mm .618inch height
1a/1c 16A power relay

LZ RELAYS (ALZ)



RoHS compliant

Protective construction: Flux-resistant type

FEATURES

- 1. Low profile type with height of 15.7 mm .618 inch**
 Slim, low profile type with dimensions of 28.8 (L) × 12.5 (W) × 15.7 (H) mm
 1.134 (L) × .492 (W) × .618 (H) inch.
- 2. High insulation resistance**
 Superior insulation characteristics have been achieved by maintaining an insulation distance between coil and contacts of at least 10 mm for both creepage distance and clearances. Furthermore, anti-surge voltage is 10 kV and higher. (Supports European reinforced insulation requirement.)
- 3. Superior heat resistance**
 Can be used in ambient temperatures up to 85°C 185°F for the class B and 105°C 221°F for the class F.
- 4. Low operating power**
 Power saved with a nominal operating power of only 400 mW.

- 5. Conforms to the various safety standards:**
 UL/C-UL, VDE approved.
- 6. Superior heat resistance and tracking resistance**
 EN60335-1 GWT compliant (Tested by VDE) type available

TYPICAL APPLICATIONS

- 1. Household electrical appliances**
 TV, CATV, Audio equipment, Microwave ovens, and Heaters, etc.
- 2. Office equipment**
 Copy machines, Packaged air conditioners, and Vending machines
- 3. Industrial equipment**
 Machine tools, Robots, and Temperature controllers

ORDERING INFORMATION

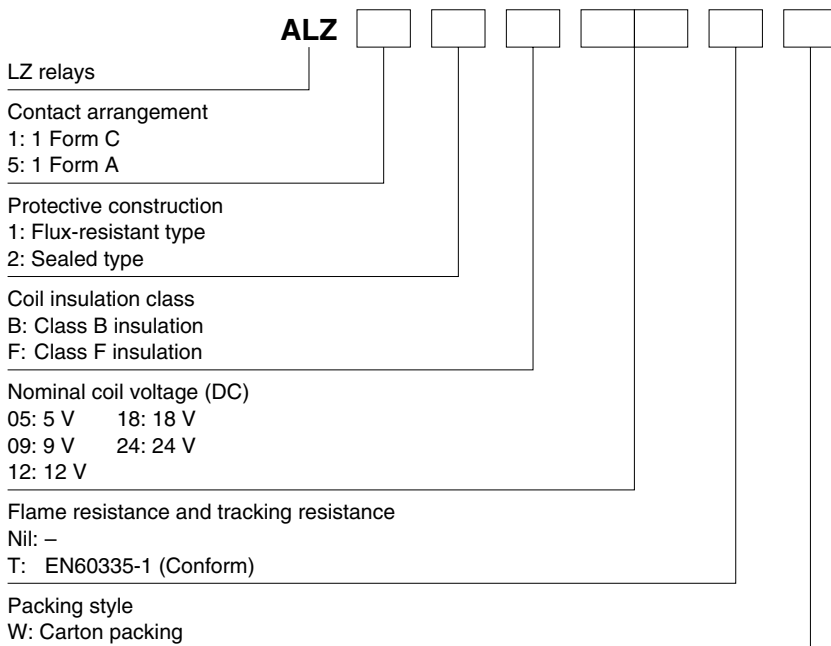

Notes: 1. Certified by UL/C-UL and VDE
 2. Tube packing type is also available. Please consult us.

TYPES

Contact arrangement	Coil voltage	Flux-resistant type		Sealed type	
		Class B insulation	Class F insulation	Class B insulation	Class F insulation
		Part No.	Part No.	Part No.	Part No.
1 Form C	5 V DC	ALZ11B05W	ALZ11F05W	ALZ12B05W	ALZ12F05W
	9 V DC	ALZ11B09W	ALZ11F09W	ALZ12B09W	ALZ12F09W
	12 V DC	ALZ11B12W	ALZ11F12W	ALZ12B12W	ALZ12F12W
	18 V DC	ALZ11B18W	ALZ11F18W	ALZ12B18W	ALZ12F18W
	24 V DC	ALZ11B24W	ALZ11F24W	ALZ12B24W	ALZ12F24W
1 Form A	5 V DC	ALZ51B05W	ALZ51F05W	ALZ52B05W	ALZ52F05W
	9 V DC	ALZ51B09W	ALZ51F09W	ALZ52B09W	ALZ52F09W
	12 V DC	ALZ51B12W	ALZ51F12W	ALZ52B12W	ALZ52F12W
	18 V DC	ALZ51B18W	ALZ51F18W	ALZ52B18W	ALZ52F18W
	24 V DC	ALZ51B24W	ALZ51F24W	ALZ52B24W	ALZ52F24W

Standard packing: Carton: 100 pcs.; Case: 500 pcs.

Notes: 1. Tube packing type is also available. Please consult us.

2. Carton packing symbol "W" is not marked on the relay.

3. EN60335-1 GWT compliant types available. When ordering, please add suffix "T".

Ex. ALZ51F12TW

RATING

1. Coil data

Nominal coil voltage	Pick-up voltage (at 20°C 68°F)	Drop-out voltage (at 20°C 68°F)	Nominal operating current [$\pm 10\%$] (at 20°C 68°F)	Coil resistance [$\pm 10\%$] (at 20°C 68°F)	Nominal operating power (at 20°C 68°F)	Max. applied voltage (at 20°C 68°F)
5 V DC	Max. 70%V nominal voltage (Initial)	Min. 10%V nominal voltage (Initial)	80 mA	63 Ω	400 mW	130%V of nominal voltage
9 V DC			44.4 mA	203 Ω		
12 V DC			33.3 mA	360 Ω		
18 V DC			22.2 mA	810 Ω		
24 V DC			16.7 mA	1,440 Ω		

2. Specifications

Characteristics	Item	Specifications	
Contact	Arrangement	1 Form C, 1 Form A	
	Contact resistance (Initial)	Max. 100 m Ω (By voltage drop 6V DC 1A)	
	Contact material	AgSnO ₂ type	
Rating	Nominal switching capacity (resistive load)	16A 250V AC	
	Max. switching power (resistive load)	4,000V A	
	Max. switching voltage	440V AC	
	Max. switching current	16A	
	Nominal operating power	400mW	
	Min. switching capacity (reference value)*1	100mA 5V DC	
Electrical characteristics	Insulation resistance (Initial)	Min. 1,000 M Ω (at 500V DC) Measurement at same location as "Breakdown voltage" section.	
	Breakdown voltage (Initial)	Between open contacts	1,000 Vrms for 1 min. (Detection current: 10mA)
		Between contacts and coil	5,000 Vrms for 1 min. (Detection current: 10mA)
	Temperature rise (coil)	Max. 55°C 131°F [with nominal coil voltage and at 16A contact carrying current (resistance method) at 20°C 68°F]	
	Surge breakdown voltage*2 (Between contacts and coil) (Initial)	10,000 V	
	Operate time (at nominal voltage) (at 20°C 68°F)	Max. 15ms (excluding contact bounce time)	
Release time (at nominal voltage) (at 20°C 68°F)	Max. 5ms (excluding contact bounce time, without diode)		
Mechanical characteristics	Shock resistance	Functional	100 m/s ² (Half-wave pulse of sine wave: 11ms; detection time: 10 μ s)
		Destructive	1,000 m/s ² (Half-wave pulse of sine wave: 6ms)
	Vibration resistance	Functional	10 to 55Hz at double amplitude of 1.5mm (Detection time: 10 μ s) (Only the N.C. side of 1 Form C is 0.8mm)
		Destructive	10 to 55Hz at double amplitude of 1.5mm
Expected life	Mechanical (at 180 times/min.)	Min. 10 ⁷	
	Electrical (at 20 times/min.)*3	N.O.: Min. 10 ⁵ , N.C.: Min. 5 \times 10 ⁴	
Conditions	Conditions for operation, transport and storage*4, *5	Ambient temperature: -40°C to +85°C -40°F to +185°F (Class B), Humidity: 5 to 85% R.H. (Not freezing and condensing at low temperature)	
	Max. operating speed	20 times/min. (at nominal switching capacity)	
Unit weight		Approx. 12 g .42 oz	

Notes: *1. This value can change due to the switching frequency, environmental conditions, and desired reliability level, therefore it is recommended to check this with the actual load.

*2. Wave is standard shock voltage of $\pm 1.2 \times 50\mu$ s according to JEC-212-1981.

*3. In order to obtain the full rated life cycles, the relay should be properly vented by removing the vent nib. More detail, please look at caution for NOTES.

*4. Class F type is ambient temperature 105°C 221°F.

*5. The upper limit of the ambient temperature is the maximum temperature that can satisfy the coil temperature rise value. Refer to Usage, transport and storage conditions in NOTES.

*Please note that some of the specifications listed above may not comply with overseas standards.

REFERENCE DATA

1. Max. switching power (AC resistive load)

2. Max. switching power (DC resistive load)

3. Coil temperature rise

Sample: ALZ11F12, 5pcs.
Measured portion: coil inside
Contact current: 0 A, 16 A

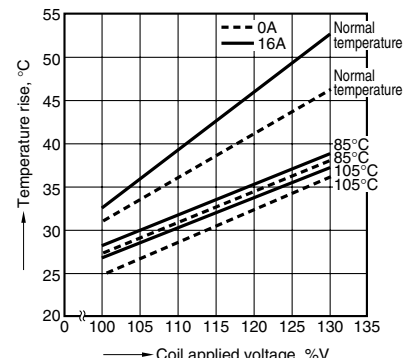
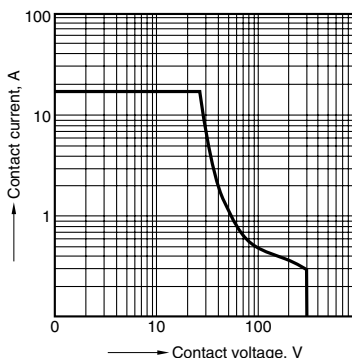
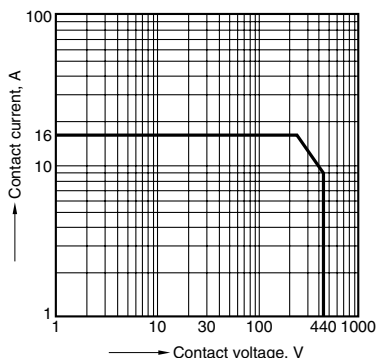

DIMENSIONS (mm inch)

The CAD data of the products with a **CAD Data** mark can be downloaded from: <http://industrial.panasonic.com/ac/e/>

1. 1 Form A type

CAD Data



External dimensions

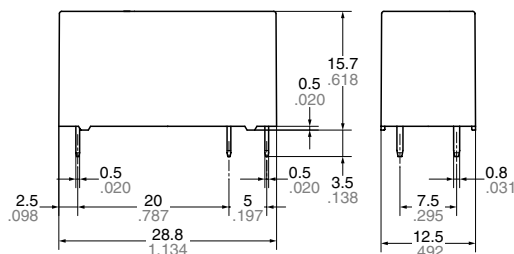

PC board pattern

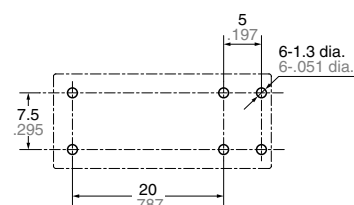

Tolerance: $\pm 0.1 \pm 0.004$

Schematic (Bottom view)

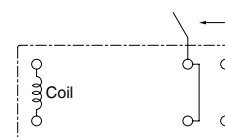

Dimension:	Tolerance
Less than 1mm .039inch:	$\pm 0.1 \pm 0.004$
Min. 1mm .039inch less than 3mm .118 inch:	$\pm 0.2 \pm 0.008$
Min. 3mm .118 inch:	$\pm 0.3 \pm 0.012$

2. 1 Form C type

CAD Data



External dimensions

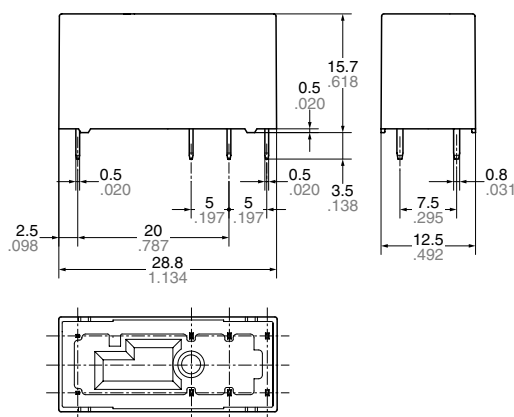

PC board pattern

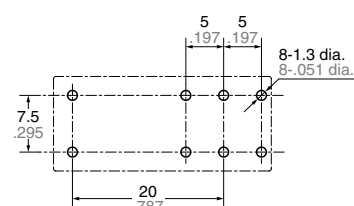

Tolerance: $\pm 0.1 \pm 0.004$

Schematic (Bottom view)

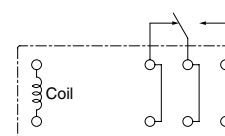

Dimension:	Tolerance
Less than 1mm .039inch:	$\pm 0.1 \pm 0.004$
Min. 1mm .039inch less than 3mm .118 inch:	$\pm 0.2 \pm 0.008$
Min. 3mm .118 inch:	$\pm 0.3 \pm 0.012$

SAFETY STANDARDS

UL/C-UL (Recognized)		VDE (Certified)		TV rating (UL/CSA)	
File No.	Contact rating	File No.	Contact rating	File No.	Rating
E43149	16A 277V AC, 34.8LRA/7.2FLA/120V AC, 15LRA/3FLA/120V AC 10LRA/3FLA 240V AC, 20A 240V AC (N.O. only) 16A 30V DC, 25A 240V AC, 15A 240V AC Resistive load 105°C 221°F (N.O. only)	40000380	16A 250V AC (cos ϕ =1.0)	C-UL E43149	TV-5

* CSA standard: Certified by C-UL

NOTES

1. For cautions for use, please read

“GENERAL APPLICATION

GUIDELINES” on page B-1.

2. Electrical life (Sealed type)

In order to obtain the full rated life cycles, the relay should be properly vented by removing the vent nib after the soldering/ washing process.

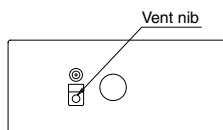

Mouser Electronics

Authorized Distributor

Click to View Pricing, Inventory, Delivery & Lifecycle Information:

Panasonic:

[ALZ12F48](#) [ALZ11B05](#) [ALZ11B05W](#) [ALZ11B06](#) [ALZ11B06W](#) [ALZ11B09](#) [ALZ11B09W](#) [ALZ11B12](#) [ALZ11B12W](#)
[ALZ11B18](#) [ALZ11B18W](#) [ALZ11B24](#) [ALZ11B24W](#) [ALZ11B48](#) [ALZ11B48W](#) [ALZ11B4H](#) [ALZ11B4HW](#) [ALZ11F05](#)
[ALZ11F05W](#) [ALZ11F06](#) [ALZ11F06W](#) [ALZ11F09](#) [ALZ11F09W](#) [ALZ11F12](#) [ALZ11F12W](#) [ALZ11F18](#) [ALZ11F18W](#)
[ALZ11F24](#) [ALZ11F24W](#) [ALZ11F48](#) [ALZ11F48W](#) [ALZ11F4H](#) [ALZ11F4HW](#) [ALZ12B05](#) [ALZ12B05W](#) [ALZ12B06](#)
[ALZ12B06W](#) [ALZ12B09](#) [ALZ12B09W](#) [ALZ12B12W](#) [ALZ12B18](#) [ALZ12B18W](#) [ALZ12B24W](#) [ALZ12B48](#) [ALZ12B48W](#)
[ALZ12B4H](#) [ALZ12B4HW](#) [ALZ12F05](#) [ALZ12F05W](#) [ALZ12F06](#) [ALZ12F06W](#) [ALZ12F09](#) [ALZ12F09W](#) [ALZ12F12W](#)
[ALZ12F18](#) [ALZ12F18W](#) [ALZ12F22](#) [ALZ12F22W](#) [ALZ12F24W](#) [ALZ12F48W](#) [ALZ12F4H](#) [ALZ12F4HW](#) [ALZ22B05](#)
[ALZ22B05W](#) [ALZ22B06](#) [ALZ22B06W](#) [ALZ22B09](#) [ALZ22B09W](#) [ALZ22B12W](#) [ALZ22B18](#) [ALZ22B18W](#) [ALZ22B24W](#)
[ALZ22B48](#) [ALZ22B48W](#) [ALZ22B4H](#) [ALZ22B4HW](#) [ALZ22F05](#) [ALZ22F05W](#) [ALZ22F06](#) [ALZ22F06W](#) [ALZ22F09](#)
[ALZ22F09W](#) [ALZ22F12W](#) [ALZ22F18](#) [ALZ22F18W](#) [ALZ22F24W](#) [ALZ22F48](#) [ALZ22F48W](#) [ALZ22F4H](#) [ALZ22F4HW](#)
[ALZ51B05W](#) [ALZ51B09W](#) [ALZ51B12W](#) [ALZ51B18W](#) [ALZ51B24W](#) [ALZ51B48W](#) [ALZ51F05W](#) [ALZ51F09W](#)
[ALZ51F12W](#) [ALZ51F18W](#)

Компания «Океан Электроники» предлагает заключение долгосрочных отношений при поставках импортных электронных компонентов на взаимовыгодных условиях!

Наши преимущества:

- Поставка оригинальных импортных электронных компонентов напрямую с производств Америки, Европы и Азии, а так же с крупнейших складов мира;
- Широкая линейка поставок активных и пассивных импортных электронных компонентов (более 30 млн. наименований);
- Поставка сложных, дефицитных, либо снятых с производства позиций;
- Оперативные сроки поставки под заказ (от 5 рабочих дней);
- Экспресс доставка в любую точку России;
- Помощь Конструкторского Отдела и консультации квалифицированных инженеров;
- Техническая поддержка проекта, помощь в подборе аналогов, поставка прототипов;
- Поставка электронных компонентов под контролем ВП;
- Система менеджмента качества сертифицирована по Международному стандарту ISO 9001;
- При необходимости вся продукция военного и аэрокосмического назначения проходит испытания и сертификацию в лаборатории (по согласованию с заказчиком);
- Поставка специализированных компонентов военного и аэрокосмического уровня качества (Xilinx, Altera, Analog Devices, Intersil, Interpoint, Microsemi, Actel, Aeroflex, Peregrine, VPT, Syfer, Eurofarad, Texas Instruments, MS Kennedy, Miteq, Cobham, E2V, MA-COM, Hittite, Mini-Circuits, General Dynamics и др.);

Компания «Океан Электроники» является официальным дистрибьютором и эксклюзивным представителем в России одного из крупнейших производителей разъемов военного и аэрокосмического назначения «JONHON», а так же официальным дистрибьютором и эксклюзивным представителем в России производителя высокотехнологичных и надежных решений для передачи СВЧ сигналов «FORSTAR».



JONHON

«JONHON» (основан в 1970 г.)

Разъемы специального, военного и аэрокосмического назначения:

(Применяются в военной, авиационной, аэрокосмической, морской, железнодорожной, горно- и нефтедобывающей отраслях промышленности)

«FORSTAR» (основан в 1998 г.)

ВЧ соединители, коаксиальные кабели, кабельные сборки и микроволновые компоненты:

(Применяются в телекоммуникациях гражданского и специального назначения, в средствах связи, РЛС, а так же военной, авиационной и аэрокосмической отраслях промышленности).



Телефон: 8 (812) 309-75-97 (многоканальный)

Факс: 8 (812) 320-03-32

Электронная почта: ocean@oceanchips.ru

Web: <http://oceanchips.ru/>

Адрес: 198099, г. Санкт-Петербург, ул. Калинина, д. 2, корп. 4, лит. А