

**ZX5T1951G**

**60V PNP MEDIUM POWER TRANSISTOR IN SOT223**

**Features and Benefits**

- $BV_{CEO} > -60V$
- $I_C = -6A$  Continuous Collector Current
- Low Saturation Voltage (-95mV max @ -1A)
- $R_{SAT} = 40m\Omega$  for a low equivalent On-Resistance
- $h_{FE}$  specified up to -10A for a high gain hold up
- **RoHS Compliant**
- **Halogen and Antimony Free. "Green" Device (Note 1)**
- **Qualified to AEC-Q101 Standards for High Reliability**

**Mechanical Data**

- Case: SOT223
- Case Material: Molded Plastic, "Green" Molding Compound. UL Flammability Rating 94V-0
- Moisture Sensitivity: Level 1 per J-STD-020
- Terminals: Matte Tin Finish annealed over Copper Leadframe
- Weight: 0.112 grams (Approximate)

**Applications**

- Motor driving
- DC-DC modules
- Backlight inverters
- Actuator, relay, and solenoid drivers

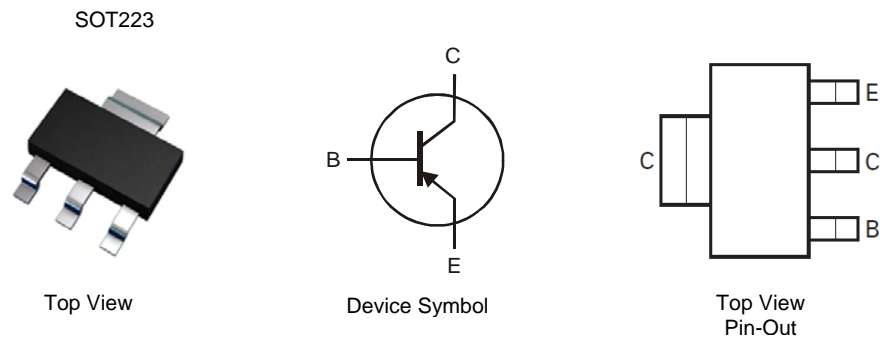

**Ordering Information** (Note 2)

Product	Marking	Reel size (inches)	Tape width (mm)	Quantity per reel
ZX5T1951GTA	ZX5T1951	7	12	1,000

Notes: 1. Diodes Inc's "Green" Policy can be found on our website at <http://www.diodes.com>  
2. For Packaging Details, go to our website at <http://www.diodes.com>.

**Marking Information**

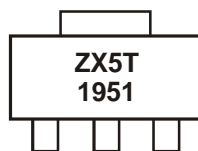

ZX5T1951 = Product type Marking Code

**Maximum Ratings** @ $T_A = 25^\circ\text{C}$  unless otherwise specified

Characteristic	Symbol	Value	Unit
Collector-Base Voltage	$V_{CBO}$	-90	V
Collector-Emitter Voltage	$V_{CES}$	-90	V
Collector-Emitter Voltage	$V_{CEO}$	-60	V
Emitter-Base Voltage	$V_{EBO}$	-7	V
Continuous Collector Current (Note 3)	$I_C$	-6	A
Peak Pulse Current	$I_{CM}$	-15	A
Base Current	$I_B$	-1	A

**Thermal Characteristics** @ $T_A = 25^\circ\text{C}$  unless otherwise specified

Characteristic	Symbol	Value	Unit
Power Dissipation Linear derating factor	$P_D$	3.0	W mW/ $^\circ\text{C}$
		24	
		1.6	
Thermal Resistance, Junction to Ambient	$R_{\theta JA}$	12.8	$^\circ\text{C/W}$
		42	
Thermal Resistance Junction to Lead	$R_{\theta JL}$	78	$^\circ\text{C/W}$
		12.3	
Operating and Storage Temperature Range	$T_J, T_{STG}$	-55 to +150	$^\circ\text{C}$

- Notes:
3. For a device surface mounted on 52mm x 52mm x 1.6mm FR4 PCB with high coverage of single sided 2oz copper, in still air conditions; the device is measured when operating in a steady-state condition.
  4. Same as note (3), except the device is surface mounted on 25mm x 25mm with 1oz copper.
  5. Thermal resistance from junction to solder-point (at the end of the collector lead).

**Thermal Characteristics**

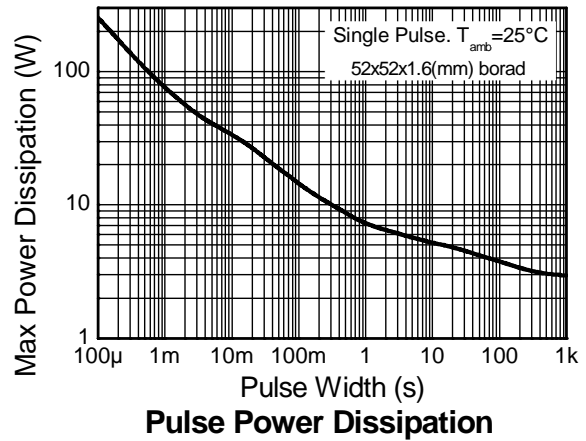
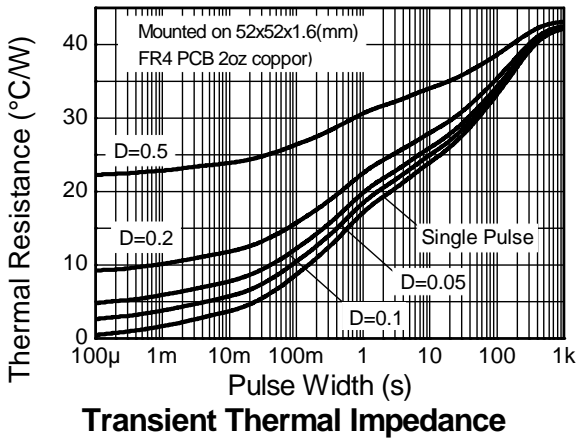
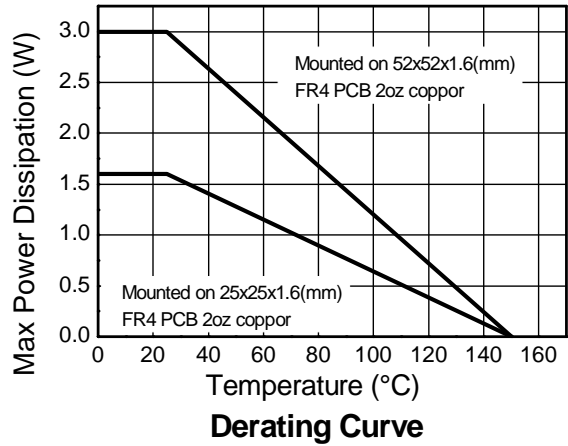
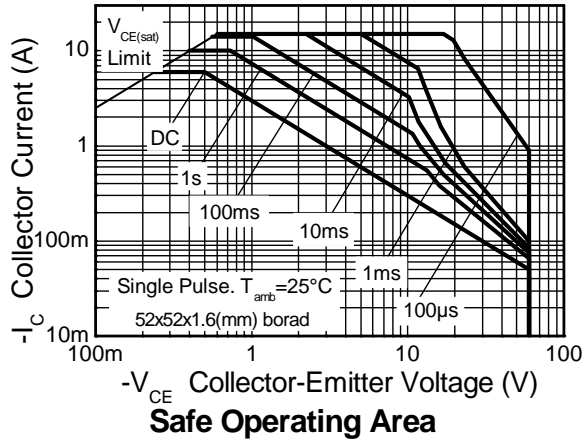

**Electrical Characteristics** @ $T_A = 25^\circ\text{C}$  unless otherwise specified

Characteristic	Symbol	Min	Typ	Max	Unit	Test Condition
Collector-Base Breakdown Voltage	$BV_{CBO}$	-90	-120	-	V	$I_C = -100\mu\text{A}$
Collector-Emitter Breakdown Voltage	$BV_{CES}$	-90	-120	-	V	$I_C = -100\mu\text{A}$
Collector-Emitter Breakdown Voltage (Note 6)	$BV_{CEO}$	-60	-80	-	V	$I_C = -10\text{mA}$
Emitter-Base Breakdown Voltage	$BV_{EBO}$	-7	-8	-	V	$I_E = -100\mu\text{A}$
Collector-Base Cutoff Current	$I_{CBO}$	-	<1	-50	nA	$V_{CB} = -72\text{V}$
Collector-Emitter Cutoff Current	$I_{CES}$	-	<1	-50	nA	$V_{CB} = -72\text{V}$
Emitter Cutoff Current	$I_{EBO}$	-	<1	-10	nA	$V_{EB} = -6\text{V}$
Static Forward Current Transfer Ratio (Note 6)	$h_{FE}$	100	240	-	-	$I_C = -10\text{mA}, V_{CE} = -2\text{V}$
		100	180	300		$I_C = -2\text{A}, V_{CE} = -2\text{V}$
		40	70	-		$I_C = -5\text{A}, V_{CE} = -2\text{V}$
		5	14	-		$I_C = -10\text{A}, V_{CE} = -2\text{V}$
Collector-Emitter Saturation Voltage (Note 6)	$V_{CE(sat)}$	-	-16	-30	mV	$I_C = -100\text{mA}, I_B = -10\text{mA}$
		-	-55	-95		$I_C = -1\text{A}, I_B = -100\text{mA}$
		-	-85	-130		$I_C = -2\text{A}, I_B = -200\text{mA}$
		-	-200	-260		$I_C = -5\text{A}, I_B = -500\text{mA}$
Base-Emitter Saturation Voltage (Note 6)	$V_{BE(sat)}$	-	-1	-1.15	V	$I_C = -5\text{A}, I_B = -500\text{mA}$
Base-Emitter Turn-On Voltage (Note 6)	$V_{BE(on)}$	-	-0.89	-1.0	V	$I_C = -5\text{A}, V_{CE} = -2\text{V}$
Output Capacitance (Note 6)	$C_{obo}$	-	33	70	pF	$V_{CB} = -10\text{V}, f = 1\text{MHz}$
Transition Frequency	$f_T$	-	120	-	MHz	$V_{CE} = -10\text{V}, I_C = -100\text{mA}$ $f = 50\text{MHz}$
Switching Time	$t_{on}$	-	33	80	ns	$V_{CC} = -10\text{V}, I_C = -2\text{A}$ $I_{B1} = -I_{B2} = -200\text{mA}$
	$t_{off}$	-	215	300		

Notes: 6. Measured under pulsed conditions. Pulse width  $\leq 300\mu\text{s}$ . Duty cycle  $\leq 2\%$

**Typical Electrical Characteristics**

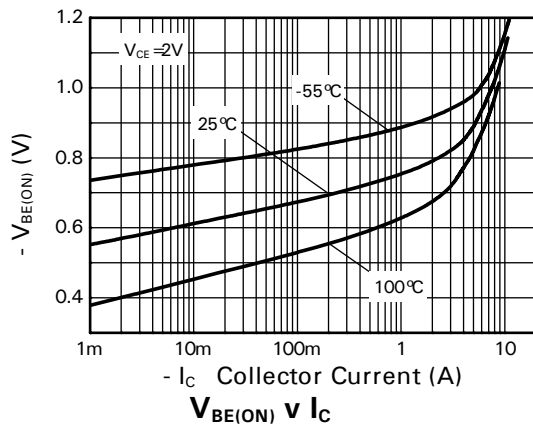
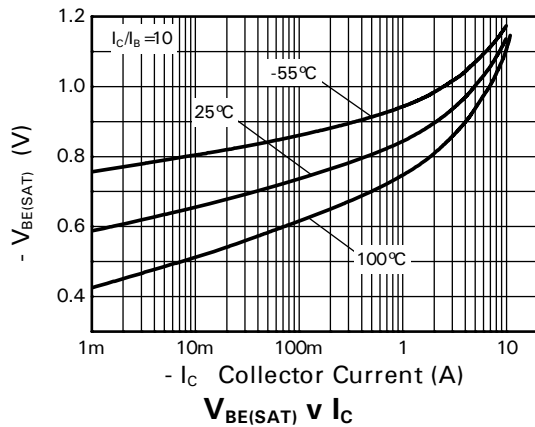
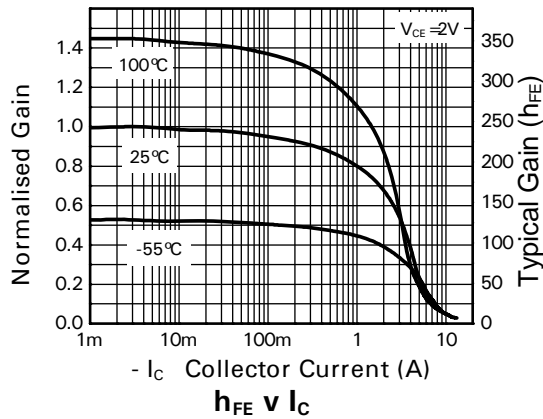
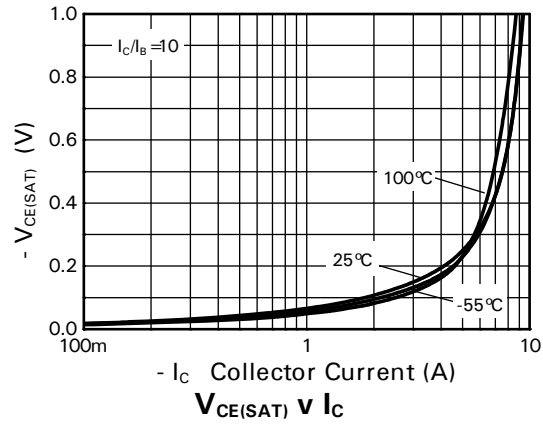
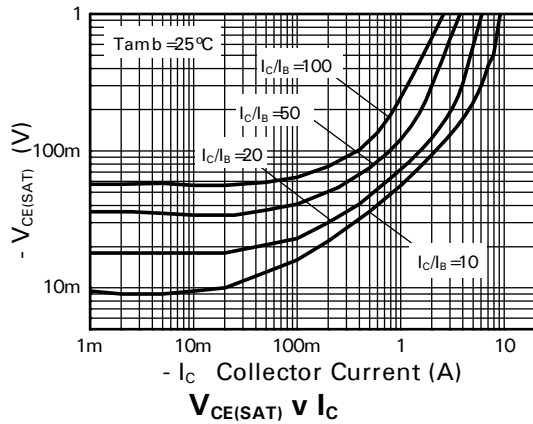

**Package Outline Dimensions**

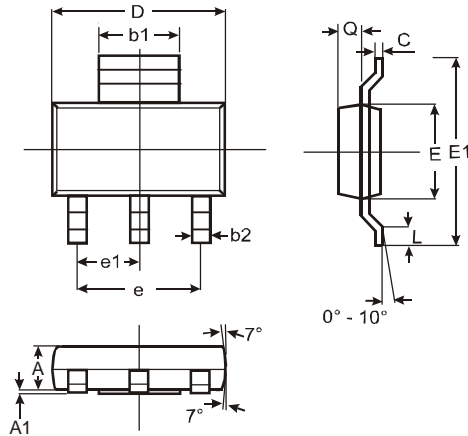

SOT223			
Dim	Min	Max	Typ
A	1.55	1.65	1.60
A1	0.010	0.15	0.05
b1	2.90	3.10	3.00
b2	0.60	0.80	0.70
C	0.20	0.30	0.25
D	6.45	6.55	6.50
E	3.45	3.55	3.50
E1	6.90	7.10	7.00
e	—	—	4.60
e1	—	—	2.30
L	0.85	1.05	0.95
Q	0.84	0.94	0.89
All Dimensions in mm			

**Suggested Pad Layout**

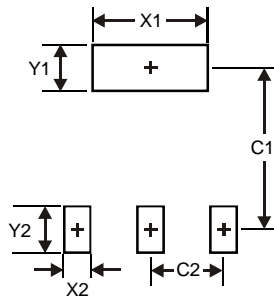

Dimensions	Value (in mm)
X1	3.3
X2	1.2
Y1	1.6
Y2	1.6
C1	6.4
C2	2.3

**IMPORTANT NOTICE**

DIODES INCORPORATED MAKES NO WARRANTY OF ANY KIND, EXPRESS OR IMPLIED, WITH REGARDS TO THIS DOCUMENT, INCLUDING, BUT NOT LIMITED TO, THE IMPLIED WARRANTIES OF MERCHANTABILITY AND FITNESS FOR A PARTICULAR PURPOSE (AND THEIR EQUIVALENTS UNDER THE LAWS OF ANY JURISDICTION).

Diodes Incorporated and its subsidiaries reserve the right to make modifications, enhancements, improvements, corrections or other changes without further notice to this document and any product described herein. Diodes Incorporated does not assume any liability arising out of the application or use of this document or any product described herein; neither does Diodes Incorporated convey any license under its patent or trademark rights, nor the rights of others. Any Customer or user of this document or products described herein in such applications shall assume all risks of such use and will agree to hold Diodes Incorporated and all the companies whose products are represented on Diodes Incorporated website, harmless against all damages.

Diodes Incorporated does not warrant or accept any liability whatsoever in respect of any products purchased through unauthorized sales channel. Should Customers purchase or use Diodes Incorporated products for any unintended or unauthorized application, Customers shall indemnify and hold Diodes Incorporated and its representatives harmless against all claims, damages, expenses, and attorney fees arising out of, directly or indirectly, any claim of personal injury or death associated with such unintended or unauthorized application.

Products described herein may be covered by one or more United States, international or foreign patents pending. Product names and markings noted herein may also be covered by one or more United States, international or foreign trademarks.

**LIFE SUPPORT**

Diodes Incorporated products are specifically not authorized for use as critical components in life support devices or systems without the express written approval of the Chief Executive Officer of Diodes Incorporated. As used herein:

A. Life support devices or systems are devices or systems which:

1. are intended to implant into the body, or
2. support or sustain life and whose failure to perform when properly used in accordance with instructions for use provided in the labeling can be reasonably expected to result in significant injury to the user.

B. A critical component is any component in a life support device or system whose failure to perform can be reasonably expected to cause the failure of the life support device or to affect its safety or effectiveness.

Customers represent that they have all necessary expertise in the safety and regulatory ramifications of their life support devices or systems, and acknowledge and agree that they are solely responsible for all legal, regulatory and safety-related requirements concerning their products and any use of Diodes Incorporated products in such safety-critical, life support devices or systems, notwithstanding any devices- or systems-related information or support that may be provided by Diodes Incorporated. Further, Customers must fully indemnify Diodes Incorporated and its representatives against any damages arising out of the use of Diodes Incorporated products in such safety-critical, life support devices or systems.

Copyright © 2011, Diodes Incorporated

[www.diodes.com](http://www.diodes.com)

Компания «Океан Электроники» предлагает заключение долгосрочных отношений при поставках импортных электронных компонентов на взаимовыгодных условиях!

Наши преимущества:

- Поставка оригинальных импортных электронных компонентов напрямую с производств Америки, Европы и Азии, а так же с крупнейших складов мира;
- Широкая линейка поставок активных и пассивных импортных электронных компонентов (более 30 млн. наименований);
- Поставка сложных, дефицитных, либо снятых с производства позиций;
- Оперативные сроки поставки под заказ (от 5 рабочих дней);
- Экспресс доставка в любую точку России;
- Помощь Конструкторского Отдела и консультации квалифицированных инженеров;
- Техническая поддержка проекта, помощь в подборе аналогов, поставка прототипов;
- Поставка электронных компонентов под контролем ВП;
- Система менеджмента качества сертифицирована по Международному стандарту ISO 9001;
- При необходимости вся продукция военного и аэрокосмического назначения проходит испытания и сертификацию в лаборатории (по согласованию с заказчиком);
- Поставка специализированных компонентов военного и аэрокосмического уровня качества (Xilinx, Altera, Analog Devices, Intersil, Interpoint, Microsemi, Actel, Aeroflex, Peregrine, VPT, Syfer, Eurofarad, Texas Instruments, MS Kennedy, Miteq, Cobham, E2V, MA-COM, Hittite, Mini-Circuits, General Dynamics и др.);

Компания «Океан Электроники» является официальным дистрибьютором и эксклюзивным представителем в России одного из крупнейших производителей разъемов военного и аэрокосмического назначения «JONHON», а так же официальным дистрибьютором и эксклюзивным представителем в России производителя высокотехнологичных и надежных решений для передачи СВЧ сигналов «FORSTAR».



## JONHON

«JONHON» (основан в 1970 г.)

Разъемы специального, военного и аэрокосмического назначения:

(Применяются в военной, авиационной, аэрокосмической, морской, железнодорожной, горно- и нефтедобывающей отраслях промышленности)

«FORSTAR» (основан в 1998 г.)

ВЧ соединители, коаксиальные кабели,  
кабельные сборки и микроволновые компоненты:

(Применяются в телекоммуникациях гражданского и специального назначения, в средствах связи, РЛС, а так же военной, авиационной и аэрокосмической отраслях промышленности).



Телефон: 8 (812) 309-75-97 (многоканальный)

Факс: 8 (812) 320-03-32

Электронная почта: [ocean@oceanchips.ru](mailto:ocean@oceanchips.ru)

Web: <http://oceanchips.ru/>

Адрес: 198099, г. Санкт-Петербург, ул. Калинина, д. 2, корп. 4, лит. А