

IEC Appliance Inlet C20 with Circuit Breaker TA35 1-pole



Rocker black  
 Lettering white, non-illuminated  
 Snap-in mounting from front side



Rocker red  
 illuminated  
 Snap-in mounting from front side



Rocker green  
 illuminated  
 Snap-in mounting from front side



See below:  
[Approvals and Compliances](#)

**Description**

- Panel mount :  
 Snap-in version from front side
- 2 Functions :  
 Appliance Inlet , Protection class I , Circuit breaker type TA35 , 1-pole
- Quick connect terminals 6.3 x 0.8 mm

**Characteristics**

- Unwired
- Switch non-illuminated or illuminated
- Suitable for use in equipment according to IEC/UL 60950

**Other versions on request**

- Pre-wired version
- Quick connect terminals 4.8 x 0.8 mm
- Protection class II, 70°C

**References**

Alternative: version for 10 A (15 A) [6135](#)  
 Substitute for type [1624-K](#)

**Weblinks**

[pdf data sheet](#), [html datasheet](#), [General Product Information](#), [Distributor-Stock-Check](#), [Accessories](#), [Detailed request for product](#), [Landing Page](#)

Newly available variants corresponding to V-Lock mating cordset. The connector is equipped with a notch intended for use with the latching cordset. The cord latching system prevents against accidental removal of the cordset.

**Technical Data**

Ratings IEC	16 A / 250 VAC; 50 Hz	appliance inlet/-outlet	C20 acc. to IEC 60320-1, UL 60320-1, CSA C22.2 no. 60320-1 (for cold conditions) pin-temperature 70 °C, 16 A, Protection Class I
Ratings UL/CSA	20 A / 250 VAC; 60 Hz	Circuit Breakers	Acc. IEC/EN 60934, UL 1077, CSA 22.2 no. 235 1-pole rocker switch, illuminated or non-illuminated. Conditional short circuit Inc: 2000 A
Dielectric Strength	> 2.5 kVAC between L-N > 3 kVAC between L/N-PE (1 min/50 Hz)		
Allowable Operation Temperature	-25 °C to 60 °C		
IP-Protection	from front side IP40 acc. to IEC 60529		
Protection against electric shock	Suitable for appliances with protection class I acc. to IEC 61140		
Terminal	Quick connect terminals 6.3 x 0.8 mm		
Panel Thickness S	Snap-in: 1.5/2/2.5 mm		
Material: Housing	Thermoplastic, black, UL 94V-0		

**Approvals and Compliances**



Detailed information on product approvals, code requirements, usage instructions and detailed test conditions can be looked up in [Details about Approvals](#)

SCHURTER products are designed for use in industrial environments. They have approvals from independent testing bodies according to national and international standards. Products with specific characteristics and requirements such as required in the automotive sector according to IATF 16949, medical technology according to ISO 13485 or in the aerospace industry can be offered exclusively with customer-specific, individual agreements by SCHURTER.

## Approvals



The approval mark is used by the testing authorities to certify compliance with the safety requirements placed on electronic products.

Approval Reference Type: 6136

Approval Logo	Certificates	Certification Body	Description
	VDE Approvals	VDE	Certificate Number: 40025196
	UL Approvals	UL	UL File Number: E96454
	CCC Approvals	CCC	CCC Certificate Number: 2015180204000153

## Product standards

Product standards that are referenced

Organization	Design	Standard	Description
	Designed according to	IEC 60320-1	Appliance couplers for household and similar general purposes
	Designed according to	UL 60320-1	Standard for Attachment Plugs and Receptacles
	Designed according to	CSA C22.2 no. 60320-1	General Use Receptacles, Attachment Plugs, and Similar Wiring Devices





## Application standards

Application standards where the product can be used

Organization	Design	Standard	Description
	Designed for applications acc.	IEC/UL 60950	IEC 60950-1 includes the basic requirements for the safety of information technology equipment.

## Compliances

The product complies with following Guide Lines

Identification	Details	Initiator	Description
	CE declaration of conformity	SCHURTER AG	The CE marking declares that the product complies with the applicable requirements laid down in the harmonisation of Community legislation on its affixing in accordance with EU Regulation 765/2008.
	RoHS	SCHURTER AG	Directive RoHS 2011/65/EU, Amendment (EU) 2015/863
	China RoHS	SCHURTER AG	The law SJ / T 11363-2006 (China RoHS) has been in force since 1 March 2007. It is similar to the EU directive RoHS.
	REACH	SCHURTER AG	On 1 June 2007, Regulation (EC) No 1907/2006 on the Registration, Evaluation, Authorization and Restriction of Chemicals 1 (abbreviated as "REACH") entered into force.
	Landing Page V-Lock	SCHURTER AG	V-Lock system are based on a matching plug-dose combination. The connector is equipped with a notch intended for use with the latching cordset. The cord latching system prevents against accidental removal of the cordset.

## Dimensions [mm]

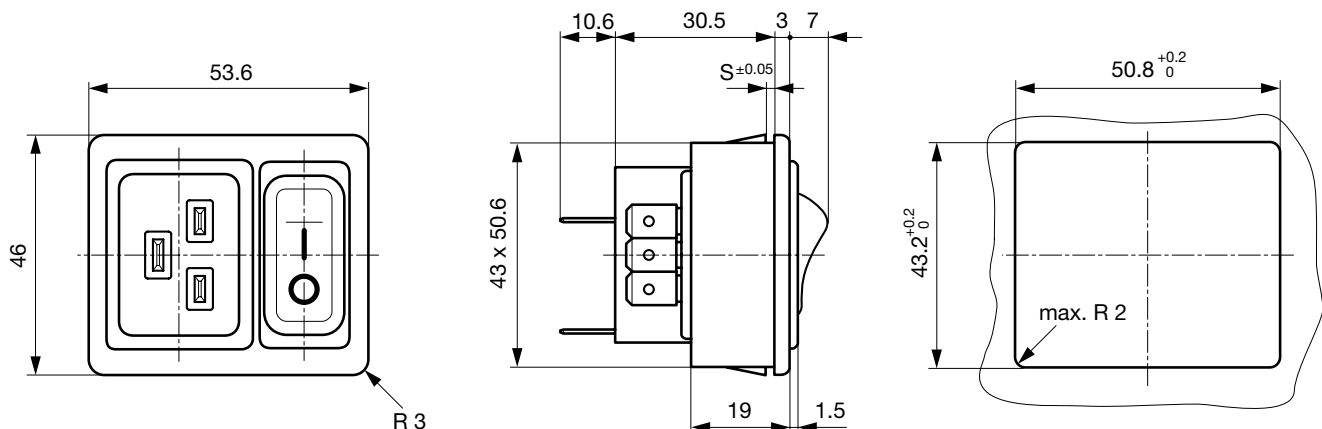

**Diagrams**

non-illuminated

illuminated (connection N' to L)

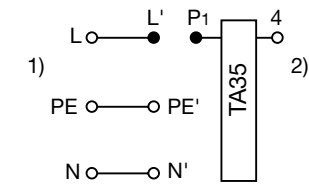

1) Line  
2) Load

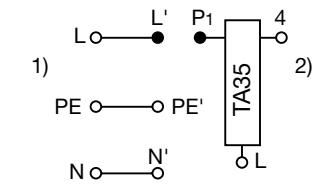

1) Line  
2) Load

**Time-Current-Curves**

Tripping Characteristics  $I_n < 3 A$

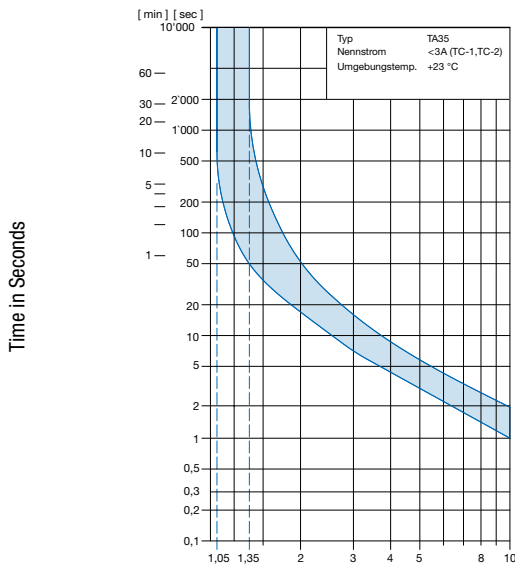

Multiple of Rated Current  $I_n$

Reference Temperature +23°

Tripping Characteristics  $I_n 3 - 20 A$

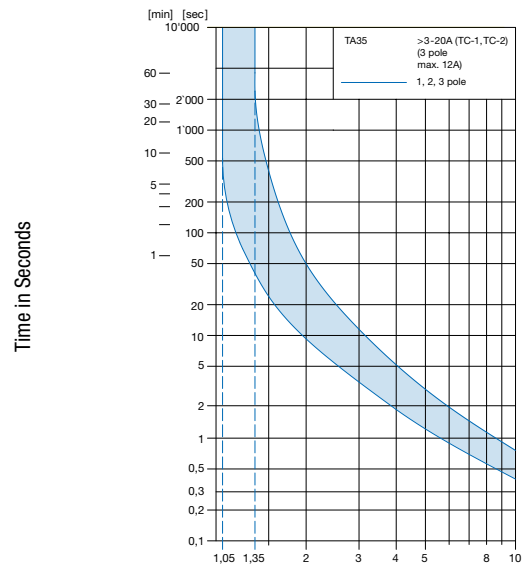

Multiple of Rated Current  $I_n$

Reference Temperature +23°

Configuration code TA35

Type	Configuration code TA35										
6136	C	F	T	W	F	1	2	0	C	0	000-1111-10-00

No other features

Rated current  $I_n$  (A)

$I_n$	Code	$I_n$	Code
1,0	J10	8,0	080
2,0	J20	10,0	100
4,0	040	12,0	120
5,0	050	15,0	150
6,0	060	16,0	160
		20,0	200*

Other rated currents on request

\*) UL / CSA only

Rocker legend

Surface	Illustration	Colour of print	Position of the rocker legend e.g. F
F embossed			
H printed		white	
K printed		black	
L printed		white	
M printed		black	

Other legends on request

Colours

	Switch front	Rocker non-illuminated	illuminated
W	black	white	-
B	black	black	-
3	black	-	red transparent
4	black	-	green transparent
6	black	-	orange transparent

Other colours on request

Number of switched poles  
 Number of protected poles

1-pole  
 1

Switch without illumination	<b>CFT</b>
Switch illuminated 240 V 120 V	<b>C2F C4F</b>

Other versions on request

Configuration code (Order example)

Type	Configuration code TA35						
6136	C F T W F 1 2 0 C 0	000	1	1	1	1	10-00

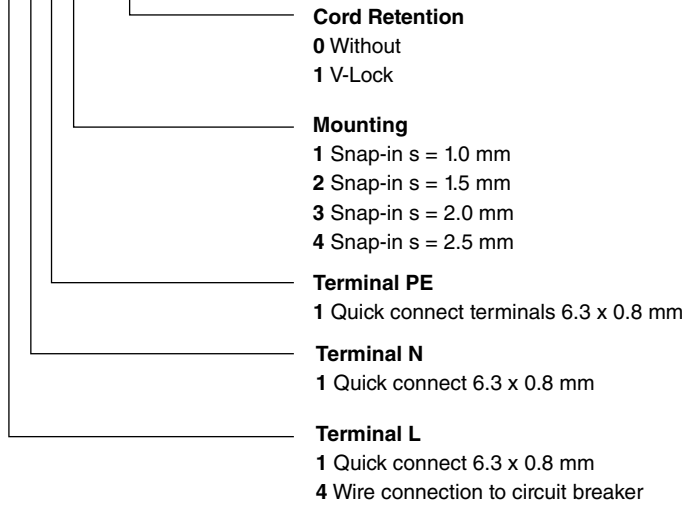

Packaging unit 15 Pcs

Mating Outlets/Connectors

Category / Description



[Connector Overview complete](#)

4795, Mounting: Power Cord, Cable Connector: IEC C19	4795
4790, Mounting: Power Cord, Screw Connector: IEC C19	4790
0104U, Mounting: Power Supply Cord, Screw clamps Connector: IEC C19	0104U

[Connector further types to 6136](#)

[Power Supply Cord Overview complete](#)



Cord Sets 16 A, Europlug, 2.5 m, Connector IEC C19, H05VV-F3G1.5, black	6004.0395
Cord Sets 16 A, Interconnection, 1.0 m, Connector IEC C19, H05VV-F3G1.5, black	6020.0392
Cord Sets 16 A, Interconnection, 2.0 m, Connector IEC C19, H05VV-F3G1.5, black	6020.0394
Cord Sets 16 A, North America, 2.5 m, Connector IEC C19, SJT 3x14 AWG, black	6009.5195

[Power Supply Cord further types to 6136](#)

Mating Outlets/Connectors shuttered



[Power Cord Overview complete](#)

VAC19KS, Overview, V-Lock cord retaining, diverse Connector IEC C19, diverse, black	VAC19KS
---	---------

[Power Cord further types to 6136](#)

Компания «Океан Электроники» предлагает заключение долгосрочных отношений при поставках импортных электронных компонентов на взаимовыгодных условиях!

Наши преимущества:

- Поставка оригинальных импортных электронных компонентов напрямую с производств Америки, Европы и Азии, а так же с крупнейших складов мира;
- Широкая линейка поставок активных и пассивных импортных электронных компонентов (более 30 млн. наименований);
- Поставка сложных, дефицитных, либо снятых с производства позиций;
- Оперативные сроки поставки под заказ (от 5 рабочих дней);
- Экспресс доставка в любую точку России;
- Помощь Конструкторского Отдела и консультации квалифицированных инженеров;
- Техническая поддержка проекта, помощь в подборе аналогов, поставка прототипов;
- Поставка электронных компонентов под контролем ВП;
- Система менеджмента качества сертифицирована по Международному стандарту ISO 9001;
- При необходимости вся продукция военного и аэрокосмического назначения проходит испытания и сертификацию в лаборатории (по согласованию с заказчиком);
- Поставка специализированных компонентов военного и аэрокосмического уровня качества (Xilinx, Altera, Analog Devices, Intersil, Interpoint, Microsemi, Actel, Aeroflex, Peregrine, VPT, Syfer, Eurofarad, Texas Instruments, MS Kennedy, Miteq, Cobham, E2V, MA-COM, Hittite, Mini-Circuits, General Dynamics и др.);

Компания «Океан Электроники» является официальным дистрибьютором и эксклюзивным представителем в России одного из крупнейших производителей разъемов военного и аэрокосмического назначения «JONHON», а так же официальным дистрибьютором и эксклюзивным представителем в России производителя высокотехнологичных и надежных решений для передачи СВЧ сигналов «FORSTAR».



## JONHON

«JONHON» (основан в 1970 г.)

Разъемы специального, военного и аэрокосмического назначения:

(Применяются в военной, авиационной, аэрокосмической, морской, железнодорожной, горно- и нефтедобывающей отраслях промышленности)

«FORSTAR» (основан в 1998 г.)

ВЧ соединители, коаксиальные кабели, кабельные сборки и микроволновые компоненты:

(Применяются в телекоммуникациях гражданского и специального назначения, в средствах связи, РЛС, а так же военной, авиационной и аэрокосмической отраслях промышленности).



Телефон: 8 (812) 309-75-97 (многоканальный)

Факс: 8 (812) 320-03-32

Электронная почта: [ocean@oceanchips.ru](mailto:ocean@oceanchips.ru)

Web: <http://oceanchips.ru/>

Адрес: 198099, г. Санкт-Петербург, ул. Калинина, д. 2, корп. 4, лит. А