

Features

- **Stereo Audio DAC**
 - 2.7V to 3.3V Analog Supply Operation
 - 2.4V to 3.3V Digital Supply Operation
 - 20-bit Stereo Audio DAC
 - 90 dB SNR Playback Stereo Channels
 - 32 Ohm/20 mW Stereo Headset Drivers with Master Volume and Mute Controls
 - Stereo Line Level Input with Volume Control/Mute and Playback through the Headset Drivers
 - Accepts Mixed Signals from All Signal Paths (Line Inputs and DAC Output)
 - 8, 11.024, 16, 22.05, 24, 32, 44.1 and 48 kHz Sampling Rates
 - 256x or 384x Fs Master Clock Frequency
 - I2S Serial Audio Interface
- **Mono Audio Power Amplifier**
 - Supply Input from Main Li-Ion Battery (3V to 5.5V)
 - 440 mW on 8 Ohm Load
 - Programmable Volume Control (-22 to +20 dB)
 - Fully Differential Structure, Input and Output
 - 8 mA Drain Current in Active Mode
 - Power-down Mode (Consumption Less than 2 μ A)
 - Minimum External Components (Direct Connection to the Loudspeaker)
- **Applications: Mobile Phones, Digital Cameras, PDAs, SmartPhones, DECT Phones, Music Players**

1. Description

The AT73C240 is a fully integrated, low-cost, combined stereo audio DAC and audio power amplifier circuit targeted for Li-Ion or Ni-Mh battery powered devices such as mobile phones, smartphones, PDA, DECT phones, digital still cameras, music players or any other type of handheld device where an audio interface is needed.

The stereo DAC section is a complete high performance, stereo, audio digital-to-analog converter delivering a 90 dB dynamic range. It comprises a multibit sigma-delta modulator with dither, continuous time analog filters and analog output drive circuitry. This architecture provides a high insensitivity to clock jitter. The digital interpolation filter increases the sample rate by a factor of 8 using 3 linear phase half-band filters cascaded, followed by a first order SINC interpolator with a factor of 8. This filter eliminates the images of baseband audio, retaining only the image at 64x the input sample rate, which is eliminated by the analog post filter. Optionally, a dither signal can be added that reduces possible noise tones at the output. However, the use of a multibit sigma-delta modulator already provides extremely low noise tone energy.

Master clock is 256 or 384 times the input data rate, allowing choice of input data rate up to 48 kHz, including standard audio rates of 48, 44.1, 32, 16 and 8 kHz.

The DAC section is followed by a volume and mute control and can be simultaneously played back directly through a stereo 32 Ohm headset pair of drivers.

The stereo 32 Ohm headset pair of drivers also includes a mixer of a LINEL and LINER pair of stereo inputs.



Power Management and Analog Companions (PMAAC)

AT73C240 Audio Interface for Portable Handsets



High quality mono output is provided. The DAC output can be connected through a buffer stage to the input of the audio power amplifier, using 2x coupling capacitors. The mono buffer stage also includes a mixer of the LINEL and LINER inputs which can be, for example, the output of a voice Codec output driver in mobile phones.

The **Audio Power Amplifier** is a differential amplifier designed in CMOS technology. It is capable of driving an 8 Ohm Loudspeaker at maximum power of 440mW, making it suitable as a hands-free speaker driver in a Wireless Handset Application.

The volume, mute, power down, de-emphasis controls and 16-bit, 18-bit and 20-bit audio formats are digitally programmable via a 4-wire SPI bus or via a 2-wire TWI bus and the digital audio data are provided through a multi-format I2S interface.

2. Block Diagram

Figure 2-1. AT73C240 Functional Block Diagram

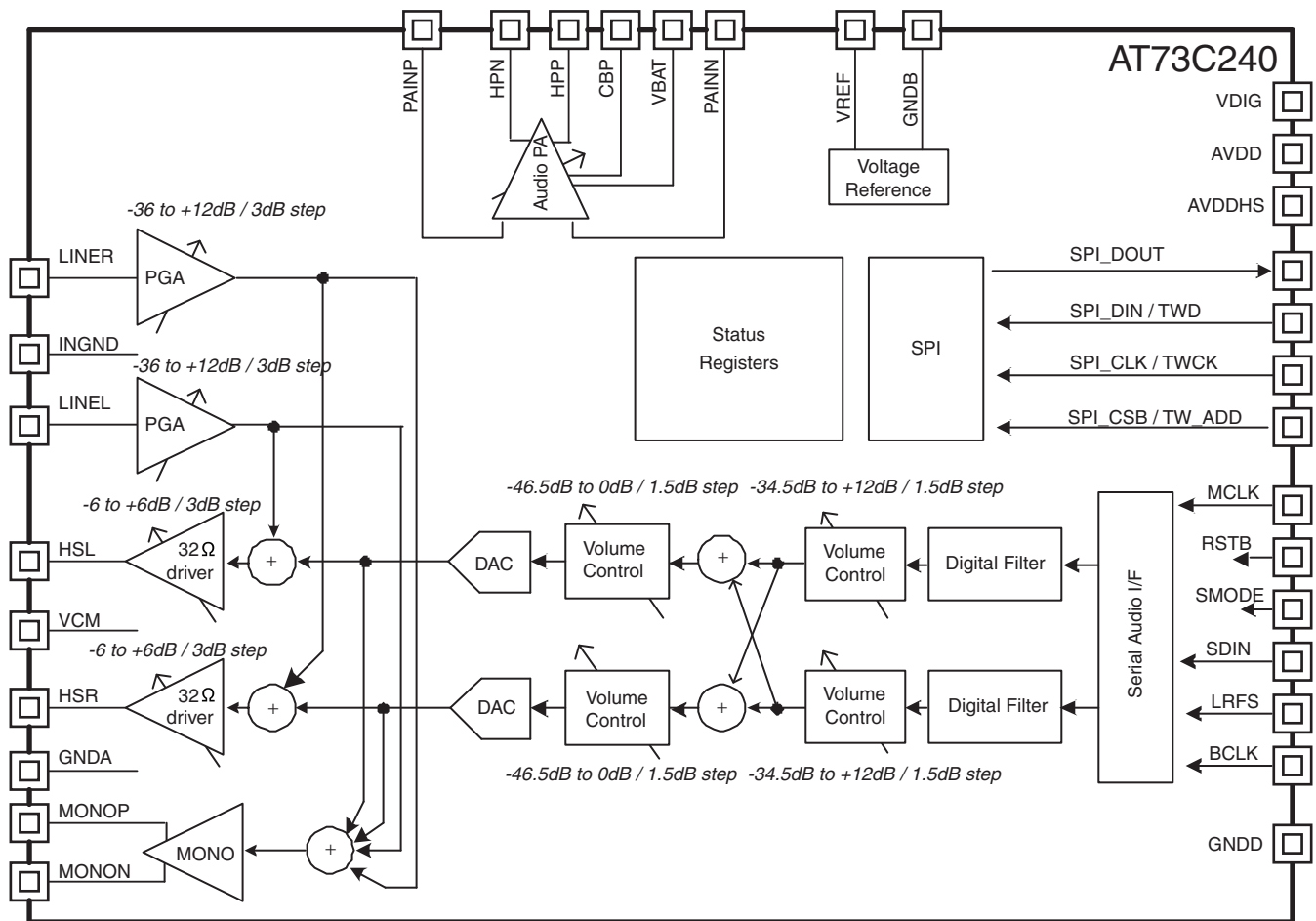

3. Pin Description

Table 3-1. Pin Description

Pin Name	I/O	Pin	Type	Function
VREF	I	1	Analog	Voltage reference pin for decoupling
AVDD	I	2	Supply	Analog supply (DAC + Line in + Mono out)
HSL	O	3	Analog	Left channel headset driver output
HSR	O	4	Analog	Right channel headset driver output
AVDDHS	I	5	Supply	Headset driver analog supply
LINEL	I	6	Analog	Left channel line in
LINER	I	7	Analog	Right channel line in
INGND	I	8	Analog	Line signal ground pin for decoupling
VCM	I	9	Analog	Common mode reference for decoupling
NC	N/A	10	N/A	Not Connected
HPN	O	11	Analog	Negative speaker output
VBAT	I	12	Supply	Audio amplifier supply
HPP	O	13	Analog	Positive speaker output
CBP	O	14	Analog	Audio amplifier common mode voltage decoupling
PAINN	I	15	Analog	Audio amplifier negative input
PAINP	I	16	Analog	Audio amplifier positive input
SDIN	I	17	Digital	Audio interface serial data input
BCLK	I	18	Digital	Audio interface bit clock
LRFS	I	19	Digital	Audio interface left/right channel synchronization frame pulse
MCLK	I	20	Digital	Audio interface master clock input
RSTB	I	21	Digital	Master reset (active low)
SMODE	I	22	Digital	Serial interface selection (to connect to ground)
GNDD	GND	23	Ground	Digital ground
VDIG	I	24	Supply	Digital supply
SPI_DOUT	O	25	Digital	SPI data output
SPI_DIN/TWD	I/O	26	Digital	SPI data input / TWI data input
SPI_CLK/TWCK	I	27	Digital	SPI clock / TWI clock
SPI_CSB/TW_ADD	I	28	Digital	SPI chip select / TWI address bit
MONON	O	29	Analog	Negative monaural driver output
MONOP	O	30	Analog	Positive monaural driver output
NC	N/A	31	N/A	Not Connected
NC	N/A	32	N/A	Not Connected
GNDA	GND	33 (Bottom)	Ground	Analog ground

4. Electrical Characteristics

Table 4-1. Absolute Maximum Ratings*

Operating Temperature (Industrial).....	-40° C to +85° C
Storage Temperature-.....	55°C to +150°C
Power Supply Input	
on VBAT-.....	0.3V to +5.5V
on VDIG, AVDD, AVDDHS-.....	0.3V to +3.6V

*NOTICE: Stresses beyond those listed under “Absolute Maximum Ratings” may cause permanent damage to the device. This is a stress rating only and functional operation of the device at these or other conditions beyond those indicated in the operational sections of this specification is not implied. Exposure to absolute maximum rating conditions for extended periods may affect device reliability.

5. Digital IOs

All the digital IOs: SDIN, BCLK, LRF5, MCLK, RSTB, SMODE, SPI_DOUT, SPI_DIN/TWD, SPI_CLK/TWCK, SPI_CSB/TW_ADD are referred to as VDIG.

Table 5-1. Digital IOs

Symbol	Parameter	Conditions	VDIG	Min	Max	Unit
VIL	Low level input voltage	Guaranteed input low Voltage	from 2.4Vto 3.3 V	-0.3	0.2 x VDIG	V
VIH	High level input voltage	Guaranteed input high Voltage	from 2.4Vto 3.3 V	0.8 x VDIG	VDIG + 0.3	V
VOL	Low level output voltage	IOL = 2 mA	from 2.4Vto 3.3 V		0.4	V
VOH	High level output voltage	IOH = 2 mA	from 2.4Vto 3.3 V	VDIG - 0.5V		V

6. Audio Power Amplifier

6.1 Electrical Specifications

V_{BAT} = 3.6V, T_A = 25°C unless otherwise noted. 100 nF capacitor connected between CBP and GNDA, 470nF input capacitors, load = 8 Ohms.

Table 6-1. Audio Power Amplifier Electrical Specifications (General Conditions: V_{DD} = 3.6V, T_A = 25°C)

Symbol	Parameter	Conditions	Min	Typ	Max	Unit
V _{DD}	Supply voltage		3	3.6	5.5	V
I _{DD}	Quiescent current	Inputs shorted, no load		6	12	mA
I _{DDstby}	Standby current				2	μA
V _{Cbp}	DC reference			V _{DD} /2		V
VOS	Output differential offset	Full gain, capacitive input coupling	-20	0	20	mV
Z _{IN}	Input impedance	Active state, maximum gain	10K	15k	20k	Ohms
		Active state, minimum gain	100K	150k	200k	
Z _{LFP}	Output load		6	8	32	Ohms
C _L	Capacitive load	Between each output and the ground			100	pF
PSRR	Power supply rejection ratio	200 to 2 kHz differential output		60		dB
F _{CL}	Low Frequency Cutoff	1 kHz reference frequency 3 dB attenuation Maximum gain		25	40	Hz
F _{CH}	High Frequency Cutoff	1 KHz reference frequency 3 dB attenuation Maximum gain	20			kHz
t _{UP}	Output setup time	Off to on mode Voltage already settled Input capacitors precharged			10	ms
V _N	Output noise	Max gain, A weighted		120	500	μV _{RMS}
THD	Output distortion	1 kHz Pout = 3mW to 300mW gain = 2dB			50	dB
P _{max}	Maximum power	1 KHz load 8 ohms		440		mW
G _{ACC}	Overall Gain accuracy		-2	0	2	dB
G _{STEP}	Gain Step Accuracy		-0.7	0	0.7	dB

7. Audio DAC

7.1 Electrical Specifications

AVDD, AVDDHS = 2.7 V, $T_A = 25^\circ\text{C}$, typical case, unless otherwise noted.

All noise and distortion specifications are measured in the 20 Hz to 0.425x F_s range and A-weighted filtered.

Full-scale levels scale proportionally with the AVDD / AVDDHS supply voltage.

Table 7-1. Electrical Specifications

	Min	Typ	Max	Units
Overall				
Operating Temperature (ambient)	-40	+25	+85	$^\circ\text{C}$
Analog Supply Voltage (AVDD, AVDDHS)	2.7	2.8	3.3	V
Digital Supply Voltage (VDIG)	2.4	2.8	3.3	V
DIGITAL INPUTS/OUTPUTS				
Resolution	20			bits
Logic Family	CMOS			
Logic Coding	2's Complement			
Analog Performance - DAC to Line-out/Headphone Output				
Output level for full scale input (for AVDD, AVDDHS = 2.8 V)		6.20 1.75		mVrms Vpp
Output common mode voltage		0.5 x AVDDHS		V
Output load resistance (on HSL, HSR)				
Headphone load	16	32		Ohms
Line load		10		kOhms
Output load capacitance (on HSL, HSR)				
Headphone load		30	1000	pF
Line load		30	150	pF
Signal to Noise Ratio (-1dBFS @ 1kHz input and 0dB Gain) Line and Headphone loads, A-Weighted		90		dB
Total Harmonic Distortion (-1dBFS @ 1kHz input and 0dB Gain)				
Line Load		-80		dB
Headphone Load		-65	-75	dB
Headphone Load (16 Ohm)		-40		dB
Dynamic Range (measured with -60 dBFS @ 1kHz input, extrapolated to full-scale), A Weighted				
Line Load		90		dB
Headphone Load		80		dB
Interchannel mismatch		0.1	1	dB
Left-channel to right-channel crosstalk (300 Hz to 20kHz)		-65		dB
Output Headset Driver Level Control Range	-5		5	dB
Output Headset Driver Level Control Step		2.5		dB
Maximum output power, headphone 32 Ohms load, 1% THD		15		mVrms

Table 7-1. Electrical Specifications (Continued)

	Min	Typ	Max	Units
Maximum output slope at power up (100 to 220 μ F coupling capacitor)			3	V/s
Analog Performance - Line-in/Microphone Input to Line-out/Headphone Output				
Output level @ AVDD, AVDDHS = 2.7 V and 0 dB gain, 500mV Rms input level, 2 X 10k Ohms loads (HSL, HSR)		1.62 570		Vpp mVrms
@ AVDD, AVDDHS = 2.7 V and 20 dB gain, 500mV Rms input level, 2 X 32 Ohms loads (HSL, HSR)		1.58 560		Vpp mVrms
Input common mode voltage		0.5 x AVDD		V
Input impedance	7	10		kOhm
Signal to Noise Ratio 500mV Rms @ 1kHz input and 0 dB gain 50mV Rms @ 1kHz input and 20 dB gain	80	85 70		dB dB
Dynamic Range (extrapolated to nominal 500mV level) -60 dB (500 mVrms) @ 1kHz input and 0 dB gain (10k Ohms load) -60 dB 50 mVrms @ 1kHz input and 20 dB gain (10k Ohms load)		85 85		dB dB
Total Harmonic Distortion, A-Weighted, line 10k Ohms load 500mV Rms @ 1kHz input and 0 dB gain 50mV Rms @ 1kHz input and 20 dB gain		-85 -78	-80 -70	dB dB
Total Harmonic Distortion, A-Weighted, line 32 Ohms load 500mV Rms @ 1kHz input and 0 dB gain 50mV Rms @ 1kHz input and 20 dB gain		-70 -65	-60 -55	dB dB
Interchannel mismatch		0.1	1	dB
Left-channel to right-channel crosstalk (300Hz to 20kHz)		-65		dB
Analog Performance - PA Driver				
Differential output level for one input 500mV Rms singlel @ AVDD, AVDDHS = 2.8 V		500		mVrms
Differential output level for stereo inputs 500mV Rms singlel @ AVDD, AVDDHS = 2.8 V, inputs internally summed		1		Vrms
Output common mode voltage		0.5xAVDDHS		V
Output load (on each input, DC decoupled to the ground)	10	50	30	kOhm pF
Gain (one single input to differential output), 20Hz to 20kHz	-05	0	0.5	dB
Signal to Noise Ratio (500mV Rms output @ 1kHz)		80		dB
Total Harmonic Distortion (500mV Rms @ 1kHz output) 2 x 10kOhm balanced load		-80		dB

Table 7-1. Electrical Specifications (Continued)

	Min	Typ	Max	Units
Master Clock				
Master Clock Maximum Long Term Jitter			1.5	ns _{pp}
Digital Filter Performance				
Frequency response (10 Hz to 20 kHz)		± 0.1		dB
Deviation from linear phase (10 Hz to 20 kHz)		± 0.1		deg
Passband 0.1 dB corner		0.4535		Fs
Stopband	0.5465			Fs
Stopband Attenuation	65			dB
De-emphasis Filter Performance (for 44.1kHz Fs)				
MAX deviation from ideal response	-1		1	dB
POWER PERFORMANCE				
Current consumption from Analog supply in power on		9		mA
Current consumption from Analog supply in power down			10	μA
Power on Settling Time				
From full power down to full power up (Vref and VCM decoupling capacitors charge)		500		ms
Line in amplifier (line in coupling capacitors charge)		50		ms
Driver amplifier (out driver DC blocking capacitors charge)		500		ms

7.2 Digital Filters Transfer Function

Figure 7-1. Channel Filter

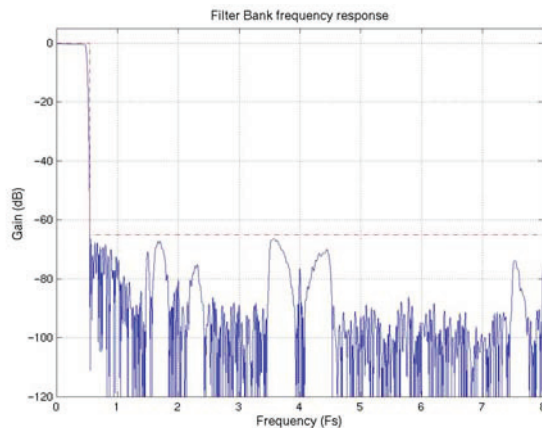

Figure 7-2. Channel Filter

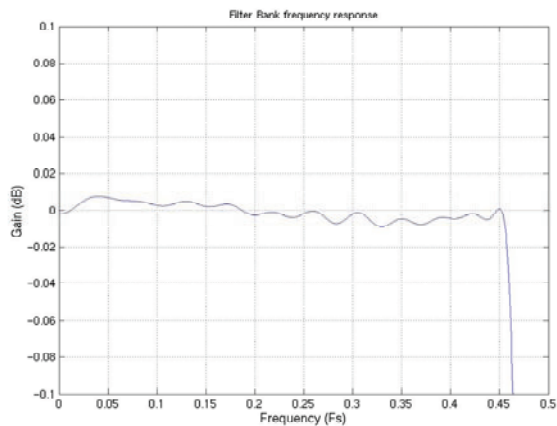
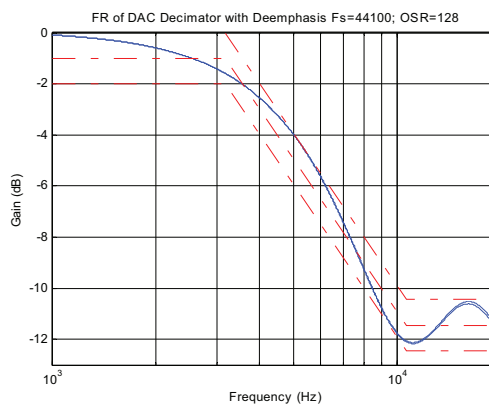

Figure 7-3. De-emphasis Filter



7.3 Data Interface

Normal operation is entered by applying correct LRFS, BCLK and SDIN waveforms to the serial interface, as illustrated in [Figure 7-4](#), [Figure 7-5](#) and [Figure 7-6](#).

To avoid noise at the output, the reset state is maintained until proper synchronization is achieved in the serial interface.

The data interface allows three different data transfer modes. See [Figure 7-4](#), [Figure 7-5](#) and [Figure 7-6](#).

Figure 7-4. 20-bit I2S Justified Mode

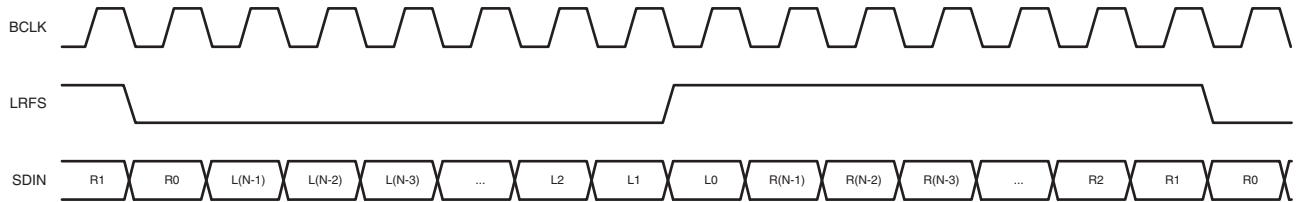

Figure 7-5. 20-bit MSB Justified Mode

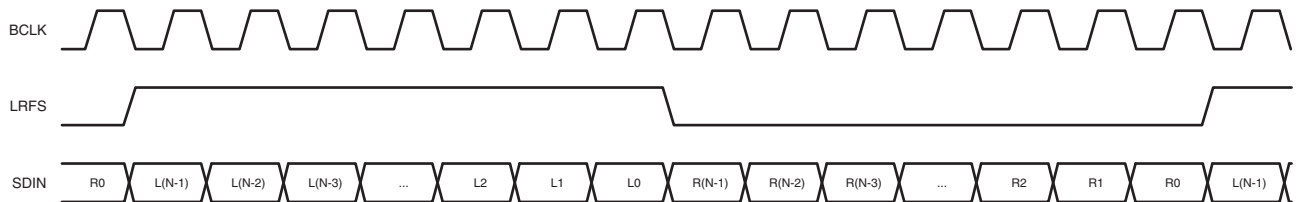
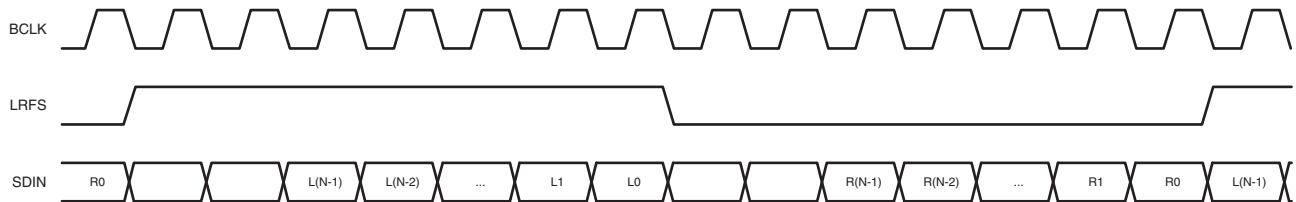

Figure 7-6. 20-bit LSB Justified Mode



The selection between modes is done using the DINTSEL<1:0> signal.

DINTSEL <1:0>	Format
00	I2S Justified
01	MSB Justified
1x	LSB Justified

The data interface always works in slave mode. This means that the LRFS and the BCLK signals are provided by the host controller. In order to achieve proper operation, the LRFS and the BCLK signals must be synchronous with the MCLK master clock signal and their frequency relationship must reflect the selected data mode. For example, if the data mode selected is the 20-bit MSB Justified, then the BCLK frequency must be 40 times higher than the LRFS frequency.

7.4 Timing Specifications

The timing constraints of the data interface are described in [Figure 7-7](#) and [Table 7-2](#) below.

Figure 7-7. Data Interface Timing Diagram

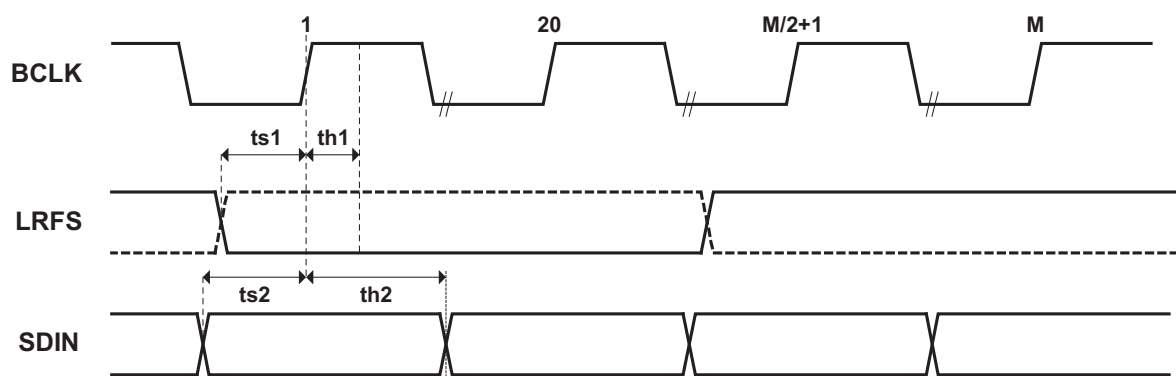

Table 7-2. Data Interface Timing Parameters

	Parameter	Min	Typ	Max	Unit
ts1	LRFS set-up time before BCLK rising edge	10			ns
th1	LRFS hold time after BCLK rising edge	10			ns
ts2	DIN set-up time before BCLK rising edge	10			ns
th2	DIN hold time after BCLK rising edge	10			ns

7.5 SMODE Selection

SMODE input is internally pulled up in the AT73C240. This ensures a **TWI** communication protocol default mode

When setting **SMODE** to 0, **SPI** communication protocol can also be used.

Two cases have to be considered:

SMODE=1, TWI protocole

SMODE=0, SPI protocole

8. SPI Interface

8.1 Architecture

The SPI is a three-wire bi-directional asynchronous serial link. It works only in slave mode. The protocol is the following:

Figure 8-1. SPI Architecture

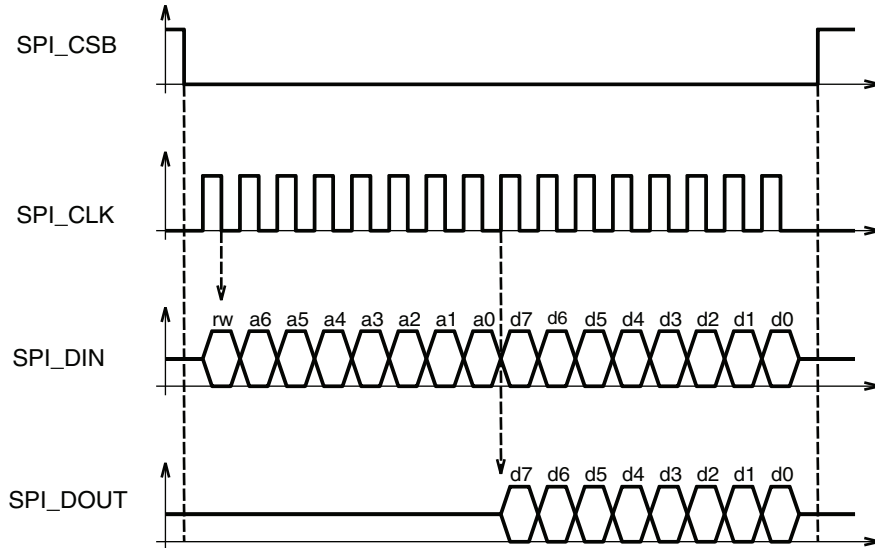

8.2 SPI Protocol

On SPI_DIN, the first bit is a read/write bit. 0 indicates a write operation, while 1 is for a read operation. The seven following bits are used for the register address and the eight last ones are the write data. For both address and data, the most significant bit is the first one.

In case of a read operation, SPI_DOUT provides the contents of the read register, MSB first.

The transfer is enabled by the CSB signal active low. When no operation is being carried out, SPI_DOUT is set high impedance to allow sharing of MCU serial interface with other devices. The interface is reset at every rising edge of SPI_CS# in order to come back to an idle state, even if the transfer does not succeed. The SPI is synchronized with the serial clock SPI_CLK. Falling edge latches SPI_DIN input and rising edge shifts SPI_DOUT output bits.

Note that MCLK must run during any SPI write access from address 0x00 to 0x11.

8.3 SPI Interface Timing

Figure 8-2. SPI Timing

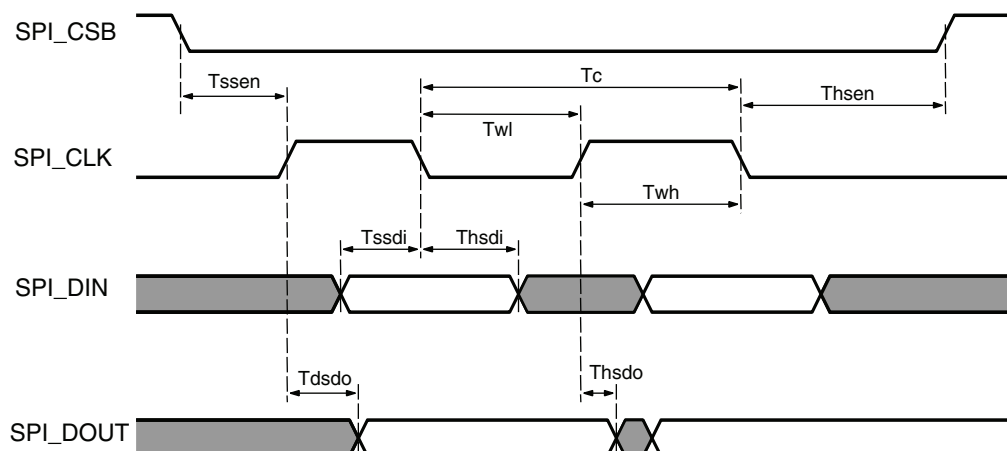

Table 8-1. SPI Timing Parameters

Parameter	Description	Min	Max
T _c	SPI_CLK min period	150 ns	-
T _{wl}	SPI_CLK min pulse width low	50 ns	-
T _{wh}	SPI_CLK min pulse width high	50 ns	-
T _{ssen}	Setup time SPI_CS# falling to SPI_CLK rising	50 ns	-
T _{hsw}	Hold time SPI_CLK falling to SPI_CS# rising	50 ns	-
T _{ssdi}	Setup time SPI_DIN valid to SPI_CLK falling	20 ns	-
T _{hsdi}	Hold time SPI_CLK falling to SPI_DIN not valid	20 ns	-
T _{dsdo}	Delay time SPI_CLK rising to SPI_DOUT valid	-	20 ns
T _{hsdo}	Hold time SPI_CLK rising to SPI_DOUT not valid	0 ns	-

9. TWI Interface

9.1 TWI Architecture

The two-wire interface interconnects components on a unique two-wire bus, made up of one clock line and one data line with speeds up to 400 Kbits per second, based on a byte oriented transfer format. The TWI is slave only and has single byte access.

The TWI adds flexibility to the power supply solution, enabling LDO regulator and Audio functionalities and paths to be controlled depending on the instantaneous application requirements.

The AT73C240 has the following 7-bit address: **1001000**.

Attempting to read data from register addresses not listed in this section results in 0xFF being read out.

- TWCK is an input pin for the clock
- TWD is an open-drain pin driving or receiving the serial data

The data put on TWD line must be 8 bits long. Data is transferred MSB first. Each byte must be followed by an acknowledgement.

Each transfer begins with a START condition and terminates with a STOP condition.

- A high-to-low transition on TWD while TWCK is high defines a START condition.
- A low-to-high transition on TWD while TWCK is high defines a STOP condition..

Figure 9-1. TWI Start and Stop conditions

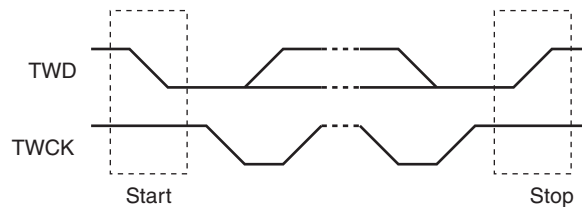
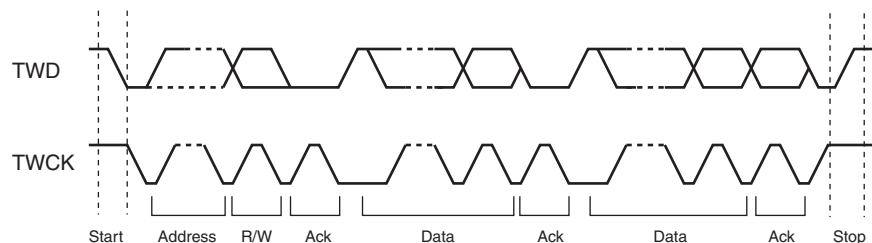

Figure 9-2. TWI transfer format



After the host initiates a START condition, it sends the 7-bit slave address defined above to notify the slave device. A read/write bit follows (read = 1, write = 0).

The device acknowledges each received byte. The first byte sent after the device address and the R/W bit, is the address of the device register the host wants to read or write.

For a write operation the data follows the internal address. For a read operation a repeated START condition needs to be generated followed by a read on the device.

Figure 9-3. TWI Write operation



Figure 9-4. TWI Read operation



- S = Start
- P = Stop
- W = Write
- R = Read
- A = Acknowledge
- N = Not Acknowledge
- DADR= Device Address
- IADR = Internal Address

10. User Interface

Table 10-1. Register Mapping

Address	Register	Name	Access	Reset State
0x00	DAC_CTRL	DAC Control	Read/Write	0x00
0x01	DAC_LDIG	DAC Left Line In Gain	Read/Write	0x05
0x02	DAC_RDIG	DAC Right Line In Gain	Read/Write	0x05
0x03	DAC_LMPG	DAC Left Master Playback Gain	Read/Write	0x08
0x04	DAC_RMPG	DAC Right Master Playback Gain	Read/Write	0x08
0x05	DAC_LLOG	DAC Left Line Out Gain	Read/Write	0x00
0x06	DAC_RLOG	DAC Right Line Out Gain	Read/Write	0x00
0x07	DAC_OLC	DAC Output Level Control	Read/Write	0x22
0x08	DAC_MC	DAC Mixer Control	Read/Write	0x09
0x09	DAC_CSFC	DAC Clock and Sampling Frequency Control	Read/Write	0x00
0x0A	DAC_MISC	DAC Miscellaneous	Read/Write	0x00
0x0C	DAC_PRECH	DAC Precharge Control	Read/Write	0x00
0x10	DAC_RST	DAC Reset	Read/Write	0x00
0x11	PA_CRTL	Power Amplifier Control	Read/Write	0x0F

Note: MSB = Bit 7, LSB = Bit 0

10.1 DAC Control Register

Register Name: DAC_CTRL

Register Address: 0x00

Reset State: 0x00

Access: Read/Write

7	6	5	4	3	2	1	0
Not Used	ONPADRV	ONDACR	ONDACL	ONLNOR	ONLNOL	ONLNIR	ONLNIL

- **ONLNIL**
Left channel line in amplifier (L to power down, H to power up)
- **ONLNIR**
Right channel line in amplifier (L to power down, H to power up)
- **ONLNOL**
Left channel line out driver (L to power down, H to power up)
- **ONLNOR**
Right channel line out driver (L to power down, H to power up)
- **ONDACL**
Left channel DAC (L to power down, H to power up)
- **ONDACR**
Right channel DAC (L to power down, H to power up)
- **ONPADRV**
Differential mono PA driver (L to power down, H to power up)

10.2 DAC Left Line In Gain Register

Register Name: DAC_LLIG

Register Address: 0x01

Reset State: 0x05

Access: Read/Write

7	6	5	4	3	2	1	0
Not Used	Not Used	Not Used	LLIG				

- **LLIG: Left channel line in analog gain selector**

LLIG<4:0>	Gain	Unit
00000	20	dB
00001	12	dB
00010	9	dB
00011	6	dB
00100	3	dB
00101	0	dB
00110	-3	dB
00111	-6	dB
01000	-9	dB
01001	-12	dB
01010	-15	dB
01011	-18	dB
01100	-21	dB
01101	-24	dB
01110	-27	dB
01111	-30	dB
10000	-33	dB
≥10001	< -60	dB

10.3 DAC Right Line In Gain Register

Register Name: DAC_RLIG

Register Address: 0x02

Reset State: 0x05

Access: Read/Write

7	6	5	4	3	2	1	0
Not Used	Not Used	Not Used	RLIG				

• **RLIG: Right channel line in analog gain selector**

RLIG<4:0>	Gain	Unit
00000	20	dB
00001	12	dB
00010	9	dB
00011	6	dB
00100	3	dB
00101	0	dB
00110	-3	dB
00111	-6	dB
01000	-9	dB
01001	-12	dB
01010	-15	dB
01011	-18	dB
01100	-21	dB
01101	-24	dB
01110	-27	dB
01111	-30	dB
10000	-33	dB
≥10001	< -60	dB

10.4 DAC Left Master Playback Gain Register

Register Name: DAC_LMPG

Register Address: 0x03

Reset State: 0x08

Access: Read/Write

7	6	5	4	3	2	1	0
Not Used	Not Used	LMPG					

- **LMPG: Left channel master playback digital gain selector**

LMPG<5:0>	Gain	Unit	LMPG<5:0>	Gain	Unit
000000	12.0	dB	010001	-13.5	dB
000001	10.5	dB	010010	-15.0	dB
000010	9.0	dB	010011	-16.5	dB
000011	7.5	dB	010100	-18.0	dB
000100	6.0	dB	010101	-19.5	dB
000101	4.5	dB	010110	-21.0	dB
000110	3.0	dB	010111	-22.5	dB
000111	1.5	dB	011000	-24.0	dB
001000	0.0	dB	011001	-25.5	dB
001001	-1.5	dB	011010	-27.0	dB
001010	-3.0	dB	011011	-28.5	dB
001011	-4.5	dB	011100	-30.0	dB
001100	-6.0	dB	011101	-31.5	dB
001101	-7.5	dB	011110	-33.0	dB
001110	-9.0	dB	011111	-34.5	dB
001111	-10.5	dB	≥ 100000	mute	dB
010000	-12.0	dB			

10.5 DAC Right Master Playback Gain Register

Register Name: DAC_RMPG

Register Address: 0x04

Reset State: 0x08

Access: Read/Write

7	6	5	4	3	2	1	0
Not Used	Not Used	RMPG					

• **RMPG: Right channel master playback digital gain selector**

RMPG<5:0>	Gain	Unit	RMPG<5:0>	Gain	Unit
000000	12.0	dB	010001	-13.5	dB
000001	10.5	dB	010010	-15.0	dB
000010	9.0	dB	010011	-16.5	dB
000011	7.5	dB	010100	-18.0	dB
000100	6.0	dB	010101	-19.5	dB
000101	4.5	dB	010110	-21.0	dB
000110	3.0	dB	010111	-22.5	dB
000111	1.5	dB	011000	-24.0	dB
001000	0.0	dB	011001	-25.5	dB
001001	-1.5	dB	011010	-27.0	dB
001010	-3.0	dB	011011	-28.5	dB
001011	-4.5	dB	011100	-30.0	dB
001100	-6.0	dB	011101	-31.5	dB
001101	-7.5	dB	011110	-33.0	dB
001110	-9.0	dB	011111	-34.5	dB
001111	-10.5	dB	≥ 100000	mute	dB
010000	-12.0	dB			

10.6 DAC Left Line Out Gain Register

Register Name: DAC_LLOG

Register Address: 0x05

Reset State: 0x00

Access: Read/Write

7	6	5	4	3	2	1	0
Not Used	Not Used	LLOG					

- **LLOG: Left channel line out digital gain selector**

LLOG<5:0>	Gain	Unit	LLOG<5:0>	Gain	Unit
000000	0	dB	010000	-24.0	dB
000001	-1.5	dB	010001	-25.5	dB
000010	-3.0	dB	010010	-27.0	dB
000011	-4.5	dB	010011	-28.5	dB
000100	-6.0	dB	010100	-30.0	dB
000101	-7.5	dB	010101	-31.5	dB
000110	-9.0	dB	010110	-33.0	dB
000111	-10.5	dB	010111	-34.5	dB
001000	-12.0	dB	011000	-36.0	dB
001001	-13.5	dB	011001	-37.5	dB
001010	-15.0	dB	011010	-39.0	dB
001011	-16.5	dB	011011	-40.5	dB
001100	-18.0	dB	011100	-42.0	dB
001101	-19.5	dB	011101	-43.5	dB
001110	-21.0	dB	011110	-45.0	dB
001111	-22.5	dB	011111	-46.5	dB
			≥ 100000	mute	dB

10.7 DAC Right Line Out Gain Register

Register Name: DAC_RLOG

Register Address: 0x06

Reset State: 0x00

Access: Read/Write

7	6	5	4	3	2	1	0
Not Used	Not Used	RLOG					

• **RLOG: Right channel line out digital gain selector**

RLOG<5:0>	Gain	Unit	RLOG<5:0>	Gain	Unit
000000	0	dB	010000	-24.0	dB
000001	-1.5	dB	010001	-25.5	dB
000010	-3.0	dB	010010	-27.0	dB
000011	-4.5	dB	010011	-28.5	dB
000100	-6.0	dB	010100	-30.0	dB
000101	-7.5	dB	010101	-31.5	dB
000110	-9.0	dB	010110	-33.0	dB
000111	-10.5	dB	010111	-34.5	dB
001000	-12.0	dB	011000	-36.0	dB
001001	-13.5	dB	011001	-37.5	dB
001010	-15.0	dB	011010	-39.0	dB
001011	-16.5	dB	011011	-40.5	dB
001100	-18.0	dB	011100	-42.0	dB
001101	-19.5	dB	011101	-43.5	dB
001110	-21.0	dB	011110	-45.0	dB
001111	-22.5	dB	011111	-46.5	dB
			≥ 100000	mute	dB

10.8 DAC Output Level Control Register

Register Name: DAC_OLC

Register Address: 0x07

Reset State: 0x22

Access: Read/Write

7	6	5	4	3	2	1	0
RSHORT	ROLC			LSHORT	LOLC		

- **LOLC: Left channel output level control selector**

LOLC	Gain	Unit
100	5	dB
011	2.5	dB
010	0	dB
001	-2.5	dB
000	-5	dB

- **LSHORT: Left channel short circuit indicator**

Persistent; after being set, bit is not cleared automatically even after the short circuit is eliminated; must be cleared by reset cycle or direct register write operation.

- **ROLC: Right channel output level control selector**

ROLC	Gain	Unit
100	5	dB
011	2.5	dB
010	0	dB
001	-2.5	dB
000	-5	dB

- **RSHORT: Right channel short circuit indicator**

Persistent; after being set, bit is not cleared automatically even after the short circuit is eliminated; must be cleared by reset cycle or direct register write operation.

10.9 DAC Mixer Control Register

Register Name: DAC_MC

Register Address: 0x08

Reset State: 0x09

Access: Read/Write

7	6	5	4	3	2	1	0
0	0	INVR	INVL	RMSMIN2	RMSMIN1	LMSMIN2	LMSMIN1

- **LMSMIN1:** Left Channel Mono/Stereo Mixer Left Mixed input enable (H to enable, L to disable)
- **LMSMIN2:** Left Channel Mono/Stereo Mixer Right Mixed input enable (H to enable, L to disable)
- **RMSMIN1:** Right Channel Mono/Stereo Mixer Left Mixed input enable (H to enable, L to disable)
- **RMSMIN2:** Right Channel Mono/Stereo Mixer Right Mixed input enable (H to enable, L to disable)
- **INVL:** Left channel mixer output invert (H to enable, L to disable)
- **INVR:** Right channel mixer output invert (H to enable, L to disable)

10.9.1 Digital Mixer Control

The Audio DAC features a digital mixer that allows the mixing and selection of multiple input sources.

The mixing/multiplexing functions are described in [Figure 10-1](#).

Figure 10-1. Digital Mixer Functions

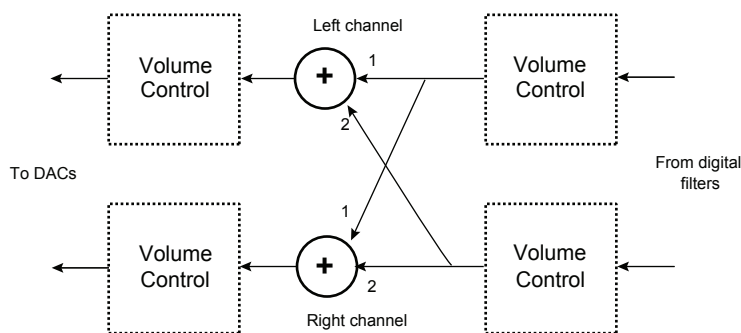

Note: When the two mixer inputs are selected, a -6 dB gain is applied to the output signal. When only one input is selected, no gain is applied.

10.10 DAC Clock and Sampling Frequency Control Register

Register Name: DAC_CSFC

Register Address: 0x09

Reset State: 0x00

Access: Read/Write

7	6	5	4	3	2	1	0
Not Used	Not Used	Not Used	OVRSEL	Not Used	Not Used	Not Used	Not Used

- **OVRSEL: Master clock selector**

L to 256 x Fs, H to 384 x Fs

Master clock and sampling frequency selection

[Table 10-2](#) describes the modes available for master clock and sampling frequency selection.

Table 10-2. Master Clock Modes

OVRSEL	Master Clock
0	256 x Fs
1	384 x Fs

10.11 DAC Miscellaneous Register

Register Name: DAC_MISC

Register Address: 0x0A

Reset State: 0x00

Access: Read/Write

7	6	5	4	3	2	1	0
Not Used	VCMCAPSEL	DINTSEL		DITHEN	DEEMPEN	NBITS	

- **NBITS<1:0>: Data interface word length**

The selection of input sample size is done using the NBITS field.

NBITS <1:0>	Format
00	16 bits
01	18 bits
10	20 bits

- **DEEMPEN: De-emphasis enable (L to disable, H to enable)**

To enable the de-emphasis filtering the DEEMPEN signal must be set to high.

- **DITHEN: Dither enable (L to disable, H to enable)**

The dither option (added in the playback channel) is enabled by setting the DITHEN signal to high.

- **DINTSEL<1:0>: I2S data format selector**

The selection between modes is done using the DINTSEL<1:0> signal.

DINTSEL<1:0>	Format
00	I2S Justified
01	MSB Justified
1x	LSB Justified

- **VCMCAPSEL: VCM decoupling capacitor selector**

Low for 10 μ F, High for 100 μ F

10.12 DAC Precharge Control Register

Register Name: DAC_PRECH

Register Address: 0x0C

Reset State: 0x00

Access: Read/Write

7	6	5	4	3	2	1	0
Not Used	Not Used	Not Used	PRCHGPDRV	PRCHGLNIR	PRCHGLNIL	PRCHG	ONMSTR

- **ONMSTR:** Master power on control (L to power down, H to power up)
- **PRCHG:** Master pre-charge (H to charge)
- **PRCHGLNIL:** Left channel line in pre-charge (H to charge)
- **PRCHGLNIR:** Right channel line in pre-charge (H to charge)
- **PRCHGPDRV:** Differential mono PA driver pre-charge (H to charge)

10.13 DAC Reset Register

Register Name: DAC_RST

Register Address: 0x10

Reset State: 0x00

Access: Read/Write

7	6	5	4	3	2	1	0
Not Used	Not Used	Not Used	Not Used	Not Used	Not Used	RESFILZ	RSTZ

- **RSTZ:** Active low reset of the audio codec
- **RESFILZ:** Active low reset of the audio codec filter

See [“Supplies and Start-up”](#) on page 30.

10.14 PA Control Register

Register Name: PA_CTRL

Register Address: 0x11

Reset State: 0x0F

Access: Read/Write

7	6	5	4	3	2	1	0
Not Used	Not Used	APAON	APAPRECH	APAGAIN			

- **APAGAIN<3:0>: Audio power amplifier gain**

APAGAIN<3:0>	Gain db	APAGAIN<3:0>	Gain db
0000	FORBIDDEN	1000	-1
0001	20	1001	-4
0010	17	1010	-7
0011	14	1011	-10
0100	11	1100	-13
0101	8	1101	-16
0110	5	1110	-19
0111	2	1111	-22

- **APAPRECH: Audio power amplifier precharge bit**

- **APAON: Audio power amplifier on bit**

APAON	APAPRECH	Operating Mode
0	0	Stand-by
0	1	Input capacitors precharge
1	0	Active mode
1	1	Forbidden state

11. Supplies and Start-up

In operating mode, VBAT (supply of the audio power amplifier) must be between 3V and 5.5V and AVDD, AVDDHS and VDIG must be inferior or equal to VBAT and lower than 3.3V.

A typical application is VBAT connected to a battery and AVDD, AVDDHS and VDIG supplied by regulators. VBAT must be present at the same time or before AVDD, AVDDHS and VDIG.

RSTB must be active (0) until the voltages are stable and reach the proper values.

To avoid noise issues, it is recommended to use ceramic decoupling capacitors for each supply close to the package as defined in the application diagram. See [Figure 13-1 on page 33](#).

The track of the supplies must be optimized to minimize the resistance, especially on VBAT where all the current from the power amplifier comes from.

HPN and HPP must be routed symmetrically and the resistance must be minimized, at the expense of maximum output power capabilities reduction.

11.1 Audio DAC Start-up Sequences

In order to minimize the noise during the start-up, a specific sequence should be applied.

[In any audio configuration, always force Bit 2 to high level \("1"\) at 0x0B address.](#)

11.1.1 Power on Example

Path DAC to headset output

1. Write @0x10 => 0x03 (deassert the reset)
2. Write @0x0C => 0x1F (precharge + master on)
3. Write @0x00 => 0x0C (ONLNOL and ONLONOR set to 1)
4. Delay 500 ms
5. Write @0x0C => 0x01 (precharge off + master on)
6. Delay 1ms
7. Write @0x00 => 0x3C (ONLNOL, ONLNOR, ONDACR and ONDAACL set to 1)

11.1.2 Power off Example

1. Write @0x00 => 0xC0 (ONDACR and ONDAACL set to 0)
2. Write @0x0C => 0x00 (master off)
3. Delay 1ms
4. Write @0x00 => 0x00 (all off)

11.1.3 I2S Example

In order to prevent I2S from generating noise at the output (for example a MP3 player switching from one song to another):

1. Set ONDAC to 0 ((bit 4 and 5 in register @0x00)
2. Stop I2S and MCLK

When I2S is restarted, in order to prevent noise generation at the output:

1. Start MCLK
2. Write @0x10 => 0x00 (RESFILZ=0, RSTZ=0)
3. Write @0x10 => 0x03 (RESFILZ=1, RSTZ=1)

4. Delay 5 ms
5. Set ONDAC to 1 (bit 4 and 5 in register @0x00)
6. Reprogram all DAC settings (Audio format, gains, etc.)
7. Start I2S.

11.2 Audio Power Amplifier Power on Sequence

To avoid an audible “click” at start-up, the input capacitors must be pre-charged before the power amplifier.

1. At start-up, disable APAON, APAGAIN<3:0> set to -22 dB, enable APAPRECH.
2. Wait 50 ms minimum.
3. Then disable APAPRECH and enable APAON.
4. Wait 10 ms min time.
5. Set the gain to the value chosen.

11.2.1 Audio Power Amplifier Power off Sequence

To avoid an audible “click” at power-off, the gain should be set to the minimum gain (-22 dB) before turning off the power amplifier.

12. Current Consumption in Different Modes

Table 12-1. Current Consumption in Different Modes

Mode	Powered up block	Current Consumption (typ)	Current Consumption (max)	Unit
0: Off	All blocks off and RSTB = 0	5	12	μA
	total	5	12	μA
1: Standby	Vref generator	0	1	μA
	Vcm generator	250	350	μA
	total	250	351	μA
2: DAC Playback Through stereo Headset (Current in the load not included)	Vref generator	0	1	μA
	Vcm generator	250	350	μA
	Left line out amplifier	850	1200	μA
	Right line out amplifier	850	1200	μA
	Left D-to-A converter	1600	2000	μA
	Right D-to-A converter	1600	2000	μA
	total	5150	6751	μA
3: Stereo DAC Playback to Audio PA (Current in the load not included)	Vref generator	0	1	μA
	Vcm generator	250	350	μA
	Left D-to-A converter	1600	2000	μA
	Right D-to-A converter	1600	2000	μA
	Differential mono PA driver	800	1200	μA
	Audio PA	6000	12000	μA
	total	10650	17551	μA
4: Playback From Stereo Line Input to Stereo Headset (Current in the load not included)	Vref generator	0	1	μA
	Vcm generator	250	350	μA
	Left line in amplifier	700	900	μA
	Right line in amplifier	700	900	μA
	Differential mono PA driver	850	1200	μA
	total	2500	3351	μA

13. Application Diagram

Figure 13-1. Application Using One Li-Ion Battery

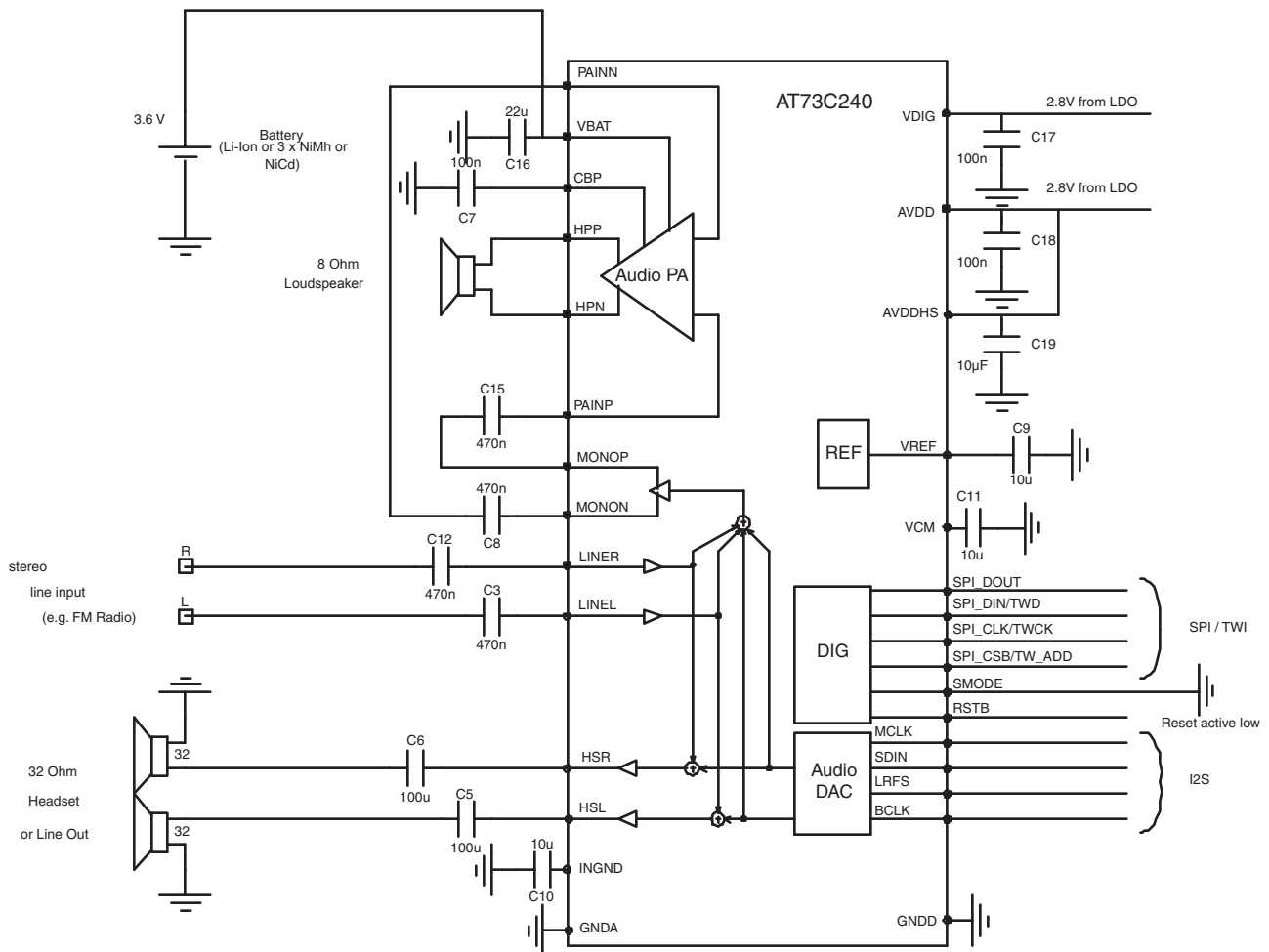

14. Components List

Table 14-1. Components List

Reference	Value	Techno	Size	Manufacturer & Reference
C3, C8, C12, C15	470 nF	Ceramic	0402	C1005X5R1A474K (TDK) or GRM155R60J474KE19 (Murata)
C5, C6	100 μ F	Ceramic	1210	C3225X5R0J107M (TDK) or GRM32ER60J107ME20 (Murata)
C9, C10, C11, C19	10 μ F	Ceramic	0603	C1608X5R0J106MT (TDK) or GRM188R60J106ME47 (Murata)
C7, C17, C18	100 nF	Ceramic	0402	C1005X5R1C104K (TDK) or GRM155R61A104KA01 (Murata)
C16	22 μ F	Ceramic	0805	C2012X5R0J226MT (TDK) or GRM21BR60J226ME39 (Murata)

15. Package Drawing

Figure 15-1.Package OutlineR-QFN032_H

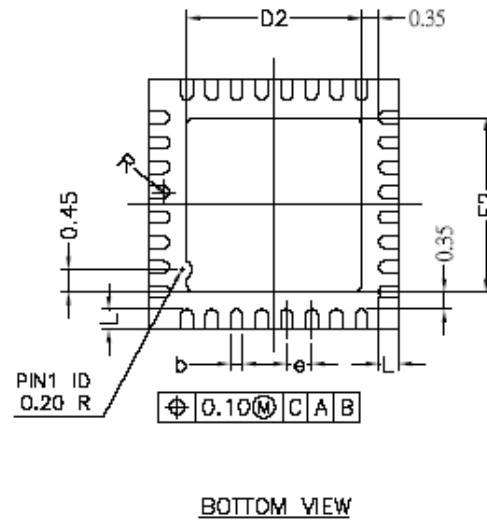
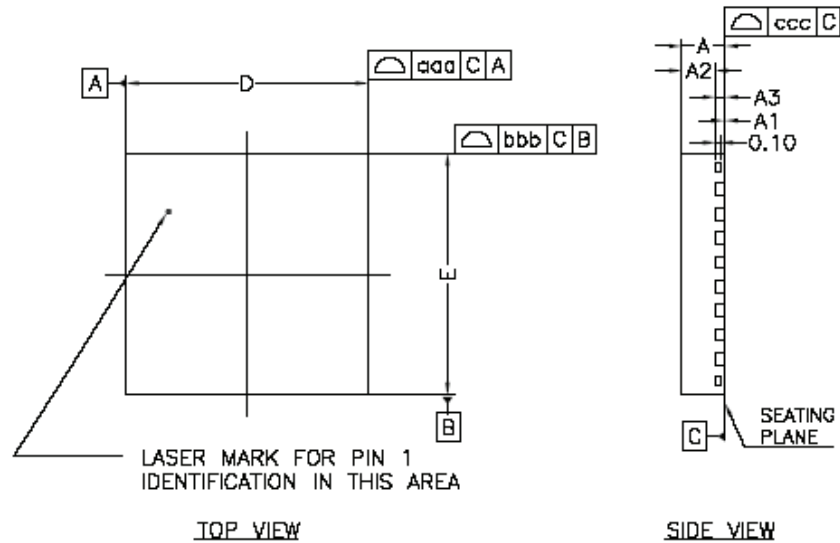

* CONTROLLING DIMENSION : MM

SYMBOL	MILLIMETER			INCH		
	MIN.	NOM.	MAX.	MIN.	NOM.	MAX.
A	---	---	0.90	---	---	0.035
A1	---	---	0.05	---	---	0.002
A2	---	0.65	0.70	---	0.026	0.028
A3	0.20 REF.		0.008 REF.			
b	0.18	0.25	0.30	0.007	0.010	0.012
D	5.00 bsc		0.197 bsc			
D2	3.40	3.50	3.60	0.134	0.138	0.142
E	5.00 bsc		0.197 bsc			
E2	3.40	3.50	3.60	0.134	0.138	0.142
L	0.35	0.40	0.45	0.014	0.016	0.028
e	0.50 bsc		0.020 bsc			
R	0.09	---	---	0.004	---	---
TOLERANCES OF FORM AND POSITION						
aaa	0.10		0.004			
bbb	0.10		0.004			
ccc	0.05		0.002			

- NOTES :
- 1.ALL DIMENSIONS ARE IN MILLIMETERS.
 - 2.DIE THICKNESS ALLOWABLE IS 0.305 mm MAXIMUM(0.012 INCHES MAXIMUM)
 - 3.DIMENSIONING & TOLERANCES CONFORM TO ASME Y14.5M. -1994.
 - 4.THE PIN #1 IDENTIFIER MUST BE PLACED ON THE TOP SURFACE OF THE PACKAGE BY USING INDENTATION MARK OR OTHER FEATURE OF PACKAGE BODY.
 - 5.EXACT SHAPE AND SIZE OF THIS FEATURE IS OPTIONAL.
 - 6.PACKAGE WARPAGE MAX 0.08 mm.
 - 7.APPLIED FOR EXPOSED PAD AND TERMINALS. EXCLUDE EMBEDDING PART OF EXPOSED PAD FROM MEASURING.
 - 8.APPLIED ONLY TO TERMINALS.

- Notes:
1. All dimensions are in mm.
 2. Drawing is for general information only. Refer to JEDEC drawing MO-220 for additional information.

Figure 15-2. Package Drawing with Pin 1 and Marking for R-QFN032_H package



16. Revision History

Doc. Rev	Comments	Change Request Ref.
6464A	First issue	



Headquarters

Atmel Corporation
2325 Orchard Parkway
San Jose, CA 95131
USA
Tel: 1(408) 441-0311
Fax: 1(408) 487-2600

International

Atmel Asia
Unit 1-5 & 16, 19/F
BEA Tower, Millennium City 5
418 Kwun Tong Road
Kwun Tong, Kowloon
Hong Kong
Tel: (852) 2245-6100
Fax: (852) 2722-1369

Atmel Europe
Le Krebs
8, Rue Jean-Pierre Timbaud
BP 309
78054 Saint-Quentin-en-
Yvelines Cedex
France
Tel: (33) 1-30-60-70-00
Fax: (33) 1-30-60-71-11

Atmel Japan
9F, Tonetsu Shinkawa Bldg.
1-24-8 Shinkawa
Chuo-ku, Tokyo 104-0033
Japan
Tel: (81) 3-3523-3551
Fax: (81) 3-3523-7581

Product Contact

Web Site
www.atmel.com
[Analog Companions \(PMAAC\)](http://www.atmel.com/analog-companions)

Technical Support
[Atmel techincal support](mailto:Atmel_techincal_support@atmel.com)
pmaac@atmel.com

Sales Contacts
www.atmel.com/contacts/

Literature Requests
www.atmel.com/literature

Disclaimer: The information in this document is provided in connection with Atmel products. No license, express or implied, by estoppel or otherwise, to any intellectual property right is granted by this document or in connection with the sale of Atmel products. **EXCEPT AS SET FORTH IN ATMEL'S TERMS AND CONDITIONS OF SALE LOCATED ON ATMEL'S WEB SITE, ATMEL ASSUMES NO LIABILITY WHATSOEVER AND DISCLAIMS ANY EXPRESS, IMPLIED OR STATUTORY WARRANTY RELATING TO ITS PRODUCTS INCLUDING, BUT NOT LIMITED TO, THE IMPLIED WARRANTY OF MERCHANTABILITY, FITNESS FOR A PARTICULAR PURPOSE, OR NON-INFRINGEMENT. IN NO EVENT SHALL ATMEL BE LIABLE FOR ANY DIRECT, INDIRECT, CONSEQUENTIAL, PUNITIVE, SPECIAL OR INCIDENTAL DAMAGES (INCLUDING, WITHOUT LIMITATION, DAMAGES FOR LOSS OF PROFITS, BUSINESS INTERRUPTION, OR LOSS OF INFORMATION) ARISING OUT OF THE USE OR INABILITY TO USE THIS DOCUMENT, EVEN IF ATMEL HAS BEEN ADVISED OF THE POSSIBILITY OF SUCH DAMAGES.** Atmel makes no representations or warranties with respect to the accuracy or completeness of the contents of this document and reserves the right to make changes to specifications and product descriptions at any time without notice. Atmel does not make any commitment to update the information contained herein. Unless specifically provided otherwise, Atmel products are not suitable for, and shall not be used in, automotive applications. Atmel's products are not intended, authorized, or warranted for use as components in applications intended to support or sustain life.

© Atmel Corporation 2009. All rights reserved. Atmel®, Atmel logo and combinations thereof are and others are registered trademarks or trademarks of Atmel Corporation or its subsidiaries. Other terms and product names may be trademarks of others.

Mouser Electronics

Authorized Distributor

Click to View Pricing, Inventory, Delivery & Lifecycle Information:

[Microchip:](#)

[AT73C240C](#) [AT73C240](#)

Компания «Океан Электроники» предлагает заключение долгосрочных отношений при поставках импортных электронных компонентов на взаимовыгодных условиях!

Наши преимущества:

- Поставка оригинальных импортных электронных компонентов напрямую с производств Америки, Европы и Азии, а так же с крупнейших складов мира;
- Широкая линейка поставок активных и пассивных импортных электронных компонентов (более 30 млн. наименований);
- Поставка сложных, дефицитных, либо снятых с производства позиций;
- Оперативные сроки поставки под заказ (от 5 рабочих дней);
- Экспресс доставка в любую точку России;
- Помощь Конструкторского Отдела и консультации квалифицированных инженеров;
- Техническая поддержка проекта, помощь в подборе аналогов, поставка прототипов;
- Поставка электронных компонентов под контролем ВП;
- Система менеджмента качества сертифицирована по Международному стандарту ISO 9001;
- При необходимости вся продукция военного и аэрокосмического назначения проходит испытания и сертификацию в лаборатории (по согласованию с заказчиком);
- Поставка специализированных компонентов военного и аэрокосмического уровня качества (Xilinx, Altera, Analog Devices, Intersil, Interpoint, Microsemi, Actel, Aeroflex, Peregrine, VPT, Syfer, Eurofarad, Texas Instruments, MS Kennedy, Miteq, Cobham, E2V, MA-COM, Hittite, Mini-Circuits, General Dynamics и др.);

Компания «Океан Электроники» является официальным дистрибьютором и эксклюзивным представителем в России одного из крупнейших производителей разъемов военного и аэрокосмического назначения «JONHON», а так же официальным дистрибьютором и эксклюзивным представителем в России производителя высокотехнологичных и надежных решений для передачи СВЧ сигналов «FORSTAR».



JONHON

«JONHON» (основан в 1970 г.)

Разъемы специального, военного и аэрокосмического назначения:

(Применяются в военной, авиационной, аэрокосмической, морской, железнодорожной, горно- и нефтедобывающей отраслях промышленности)

«FORSTAR» (основан в 1998 г.)

ВЧ соединители, коаксиальные кабели, кабельные сборки и микроволновые компоненты:

(Применяются в телекоммуникациях гражданского и специального назначения, в средствах связи, РЛС, а так же военной, авиационной и аэрокосмической отраслях промышленности).



Телефон: 8 (812) 309-75-97 (многоканальный)

Факс: 8 (812) 320-03-32

Электронная почта: ocean@oceanchips.ru

Web: <http://oceanchips.ru/>

Адрес: 198099, г. Санкт-Петербург, ул. Калинина, д. 2, корп. 4, лит. А