0.8% LOW VOLTAGE DETECTOR

NO.EA-160-160226

OUTLINE

The R3114x series are CMOS-based voltage detector ICs with high detector threshold accuracy and ultra-low supply current, which can be operated at an extremely low voltage and is used for system reset as an example.

Each of these ICs consists of a voltage reference unit, a comparator, resistors for detector threshold setting, an output driver and a hysteresis circuit. The detector threshold is fixed with high accuracy internally and does not require any adjustment.

Two output types, Nch open drain type and CMOS type are available.

The R3114x series are operable at a lower voltage than that of the R3111x series, and can be driven by a single battery.

Three types of packages, SOT-23-5, SC-82AB, and DFN(PLP)1010-4 are available.

FEATURES

- Supply Current Typ. 0.35 μ A ($-V_{DET}=1.5V$, $V_{DD}=-V_{DET}+1V$)
- Operating Voltage Range 0.5V to 6.0V ($T_{opt}=25^{\circ}C$)
- Detector Threshold Range 0.7V to 5.0V (0.1V steps)
(For other voltages, please refer to MARK INFORMATIONS.)
- Detector Threshold Accuracy $\pm 0.8\%$ ($-V_{DET} \geq 1.5V$)
- Temperature-Drift Coefficient of Detector Threshold Typ. $\pm 30ppm/^{\circ}C$
- Output Types Nch Open Drain "L" and CMOS
- Packages DFN(PLP)1010-4, SC-82AB, SOT-23-5

APPLICATIONS

- CPU and Logic Circuit Reset
- Battery Checker
- Window Comparator
- Wave Shaping Circuit
- Battery Back-up Circuit
- Power Failure Detector

BLOCK DIAGRAMS

Nch Open Drain Output (R3114xxx1A)



CMOS Output (R3114xxx1C)



SELECTION GUIDE

The package type, the detector threshold, the output type and the taping type for the ICs can be selected at the users' request.

Product Name	Package	Quantity per Reel	Pb Free	Halogen Free
R3114Kxx1*-TR	DFN(PLP)1010-4	10,000 pcs	Yes	Yes
R3114Qxx1*-TR-FE	SC-82AB	3,000 pcs	Yes	Yes
R3114Nxx1*-TR-FE	SOT-23-5	3,000 pcs	Yes	Yes

xx: The detector threshold can be designated in the range from 0.7V(07) to 5.0V(50) in 0.1V steps.
(For other voltages, please refer to MARK INFORMATIONS.)

* : Designation of Output Type
(A) Nch Open Drain
(C) CMOS

PIN CONFIGURATIONS

• DFN(PLP)1010-4*

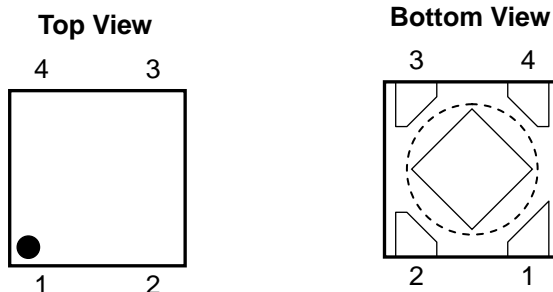

• SOT-23-5



• SC-82AB



PIN DESCRIPTIONS

• DFN(PLP)1010-4*

Pin No.	Symbol	Description
1	OUT	Output Pin ("L" at detection)
2	NC	No Connection
3	GND	Ground Pin
4	V _{DD}	Input Pin

*) Tab is GND level. (They are connected to the reverse side of this IC.)

The tab is better to be connected to the GND, but leaving it open is also acceptable.

• SOT-23-5

Pin No.	Symbol	Description
1	OUT	Output Pin ("L" at detection)
2	V _{DD}	Input Pin
3	GND	Ground Pin
4	NC	No Connection
5	NC	No Connection

• SC-82AB

Pin No.	Symbol	Description
1	OUT	Output Pin ("L" at detection)
2	V _{DD}	Input Pin
3	NC	No Connection
4	GND	Ground Pin

ABSOLUTE MAXIMUM RATINGS

Symbol	Item	Rating	Unit
V_{DD}	Supply Voltage	7.0	V
V_{OUT}	Output Voltage (Nch Open Drain Output)	$V_{SS}-0.3$ to 7.0	V
	Output Voltage (CMOS Output)	$V_{SS}-0.3$ to $V_{DD}+0.3$	
I_{OUT}	Output Current	20	mA
P_D	Power Dissipation (SOT-23-5)*	420	mW
	Power Dissipation (SC-82AB)*	380	
	Power Dissipation (DFN(PLP)1010-4)*	400	
T_{opt}	Operating Temperature Range	-40 to 85	°C
T_{stg}	Storage Temperature Range	-55 to 125	°C

*) For Power Dissipation, please refer to PACKAGE INFORMATION.

ABSOLUTE MAXIMUM RATINGS

Electronic and mechanical stress momentarily exceeded absolute maximum ratings may cause the permanent damages and may degrade the life time and safety for both device and system using the device in the field.

The functional operation at or over these absolute maximum ratings is not assured.

RECOMMENDED OPERATING CONDITIONS (ELECTRICAL CHARACTERISTICS)

All of electronic equipment should be designed that the mounted semiconductor devices operate within the recommended operating conditions. The semiconductor devices cannot operate normally over the recommended operating conditions, even if when they are used over such conditions by momentary electronic noise or surge. And the semiconductor devices may receive serious damage when they continue to operate over the recommended operating conditions.

ELECTRICAL CHARACTERISTICS

- R3114xxx1A/C values indicate $-40^{\circ}\text{C} \leq T_{\text{opt}} \leq 85^{\circ}\text{C}$, unless otherwise noted. $T_{\text{opt}}=25^{\circ}\text{C}$

Symbol	Item	Conditions	Min.	Typ.	Max.	Unit		
$-V_{\text{DET}}$	Detector Threshold	$T_{\text{opt}}=25^{\circ}\text{C}$	$1.5\text{V} < -V_{\text{DET}} \leq 5.0\text{V}$	$-V_{\text{DET}} \times 0.992$		$-V_{\text{DET}} \times 1.008$	V	
			$0.7\text{V} \leq -V_{\text{DET}} \leq 1.5\text{V}$	-12		+12	mV	
		$-40^{\circ}\text{C} \leq T_{\text{opt}} \leq 85^{\circ}\text{C}$	$1.5\text{V} < -V_{\text{DET}} \leq 5.0\text{V}$	$-V_{\text{DET}} \times 0.985$		$-V_{\text{DET}} \times 1.015$	V	
			$0.7\text{V} \leq -V_{\text{DET}} \leq 1.5\text{V}$	-22.5		+22.5	mV	
V_{HYS}	Detector Threshold Hysteresis		$-V_{\text{DET}} \times 0.04$		$-V_{\text{DET}} \times 0.07$	V		
I_{SS}	Supply Current	$V_{\text{DD}}=-V_{\text{DET}}-0.1\text{V}$	$0.7\text{V} \leq -V_{\text{DET}} < 1.6\text{V}$			1.40	μA	
			$1.6\text{V} \leq -V_{\text{DET}} < 3.1\text{V}$			1.50		
			$3.1\text{V} \leq -V_{\text{DET}} < 4.1\text{V}$			1.60		
			$4.1\text{V} \leq -V_{\text{DET}} \leq 5.0\text{V}$			1.70		
		$V_{\text{DD}}=-V_{\text{DET}}+1.0\text{V}$	$0.7\text{V} \leq -V_{\text{DET}} < 1.6\text{V}$					1.20
			$1.6\text{V} \leq -V_{\text{DET}} < 3.1\text{V}$					1.20
			$3.1\text{V} \leq -V_{\text{DET}} < 4.1\text{V}$					1.30
			$4.1\text{V} \leq -V_{\text{DET}} \leq 5.0\text{V}$					1.40
V_{DDH}	Maximum Operating Voltage				6	V		
V_{DDL}	Minimum Operating Voltage*1	$T_{\text{opt}}=25^{\circ}\text{C}$			0.50	V		
		$-40^{\circ}\text{C} \leq T_{\text{opt}} \leq 85^{\circ}\text{C}$			0.55	V		
I_{OUT}	Output Current (Driver Output Pin)	Nch	$V_{\text{DD}}=0.55\text{V}, V_{\text{DS}}=0.05\text{V}$			7	μA	
			$0.7\text{V} \leq -V_{\text{DET}} < 1.1\text{V}$	$V_{\text{DD}}=0.6\text{V}$ $V_{\text{DS}}=0.5\text{V}$			0.02	mA
			$1.1\text{V} \leq -V_{\text{DET}} < 1.6\text{V}$	$V_{\text{DD}}=1.0\text{V}$ $V_{\text{DS}}=0.5\text{V}$			0.40	
			$1.6\text{V} \leq -V_{\text{DET}} < 3.1\text{V}$	$V_{\text{DD}}=1.5\text{V}$ $V_{\text{DS}}=0.5\text{V}$			1.00	
			$3.1\text{V} \leq -V_{\text{DET}} \leq 5.0\text{V}$	$V_{\text{DD}}=3.0\text{V}$ $V_{\text{DS}}=0.5\text{V}$			2.40	
		Pch*2	$0.7\text{V} \leq -V_{\text{DET}} < 4.0\text{V}$	$V_{\text{DD}}=4.5\text{V}$ $V_{\text{DS}}=-2.1\text{V}$			0.65	mA
			$4.0\text{V} \leq -V_{\text{DET}} \leq 5.0\text{V}$	$V_{\text{DD}}=6.0\text{V}$ $V_{\text{DS}}=-2.1\text{V}$			0.90	
I_{LEAK}	Nch Driver Leakage Current*3	$V_{\text{DD}}=6.0\text{V}, V_{\text{DS}}=7.0\text{V}$			80	nA		
$\Delta V_{\text{DET}} / \Delta T_{\text{opt}}$	Detector Threshold Temperature Coefficient			± 30		ppm/ $^{\circ}\text{C}$		
t_{PLH}	Output Delay Time	$V_{\text{DD}}=0.55\text{V}$ to $-V_{\text{DET}}+2.0\text{V}$ or 6.0V		40		μs		

All of unit are tested and specified under load conditions such that $T_{\text{opt}}=25^{\circ}\text{C}$ except for Detector Threshold Temperature Coefficient.

*1: Minimum operating voltage means the value of input voltage when output voltage maintains 0.1V or less.
(In case of Nch Open Drain Output type, the output pin is pulled up with a resistance of 470k Ω to 5.0V)

*2: In case of CMOS type

*3: In case of Nch Open Drain type

TIMING CHART



DEFINITION OF OUTPUT DELAY TIME

Output Delay Time (t_{PLH}) is defined as follows:

1. In the case of Nch Open Drain Output:

Under the condition of the output pin (OUT) is pulled up through a resistor of 470k Ω to 5V, the time interval between the rising edge of V_{DD} pulse from 0.55V to $(-V_{DET})+2.0V$ or the time interval of 6.0V pulse voltage is supplied, the becoming of the output voltage to 2.5V.

2. In the case of CMOS Output:

The time interval between the rising edge of V_{DD} pulse from 0.55V to $(-V_{DET})+2.0V$ or the time interval of 6.0V pulse voltage is supplied, the becoming of the output voltage to $((-V_{DET})+2.0V)/2$ or 3.0V.



ELECTRICAL CHARACTERISTICS BY DETECTOR THRESHOLD

• R3114x071A/C to R3114x501A/C

Bold values are checked and guaranteed by design engineering at $-40^{\circ}\text{C} \leq T_{\text{opt}} \leq 85^{\circ}\text{C}$, unless otherwise noted.

$T_{\text{opt}}=25^{\circ}\text{C}$

Part Number	Detector Threshold1		Detector Threshold2		Detector Threshold Hysteresis		Supply Current1		Supply Current2		Max. Op. Voltage	Min. Op. Voltage
	-V _{DET1} [V]		-V _{DET2} [V]		V _{HYS} [V]		I _{SS1} [μA]		I _{SS2} [μA]		V _{DDH} [V]	V _{DDL} [V]
	Min.	Max.	Min.	Max.	Min.	Max.	Cond.	Max.	Cond.	Max.	Max.	Max.
R3114x071A/C	0.6880	0.7120	0.6775	0.7225	0.028	0.049	V _{DD} = -V _{DET} -0.1V	1.400				0.50
R3114x081A/C	0.7880	0.8120	0.7775	0.8225	0.032	0.056						
R3114x091A/C	0.8880	0.9120	0.8775	0.9225	0.036	0.063						
R3114x101A/C	0.9880	1.0120	0.9775	1.0225	0.040	0.070						
R3114x111A/C	1.0880	1.1120	1.0775	1.1225	0.044	0.077						
R3114x121A/C	1.1880	1.2120	1.1775	1.2225	0.048	0.084						
R3114x131A/C	1.2880	1.3120	1.2775	1.3225	0.052	0.091						
R3114x141A/C	1.3880	1.4120	1.3775	1.4225	0.056	0.098						
R3114x151A/C	1.4880	1.5120	1.4775	1.5225	0.060	0.105						
R3114x161A/C	1.5872	1.6128	1.5760	1.6240	0.064	0.112						
R3114x171A/C	1.6864	1.7136	1.6745	1.7255	0.068	0.119						
R3114x181A/C	1.7856	1.8144	1.7730	1.8270	0.072	0.126						
R3114x191A/C	1.8848	1.9152	1.8715	1.9285	0.076	0.133						
R3114x201A/C	1.9840	2.0160	1.9700	2.0300	0.080	0.140						
R3114x211A/C	2.0832	2.1168	2.0685	2.1315	0.084	0.147						
R3114x221A/C	2.1824	2.2176	2.1670	2.2330	0.088	0.154						
R3114x231A/C	2.2816	2.3184	2.2655	2.3345	0.092	0.161						
R3114x241A/C	2.3808	2.4192	2.3640	2.4360	0.096	0.168						
R3114x251A/C	2.4800	2.5200	2.4625	2.5375	0.100	0.175						
R3114x261A/C	2.5792	2.6208	2.5610	2.6390	0.104	0.182						
R3114x271A/C	2.6784	2.7216	2.6595	2.7405	0.108	0.189						
R3114x281A/C	2.7776	2.8224	2.7580	2.8420	0.112	0.196						
R3114x291A/C	2.8768	2.9232	2.8565	2.9435	0.116	0.203						
R3114x301A/C	2.9760	3.0240	2.9550	3.0450	0.120	0.210						
R3114x311A/C	3.0752	3.1248	3.0535	3.1465	0.124	0.217						
R3114x321A/C	3.1744	3.2256	3.1520	3.2480	0.128	0.224						
R3114x331A/C	3.2736	3.3264	3.2505	3.3495	0.132	0.231						
R3114x341A/C	3.3728	3.4272	3.3490	3.4510	0.136	0.238						
R3114x351A/C	3.4720	3.5280	3.4475	3.5525	0.140	0.245						
R3114x361A/C	3.5712	3.6288	3.5460	3.6540	0.144	0.252						
R3114x371A/C	3.6704	3.7296	3.6445	3.7555	0.148	0.259						
R3114x381A/C	3.7696	3.8304	3.7430	3.8570	0.152	0.266						
R3114x391A/C	3.8688	3.9312	3.8415	3.9585	0.156	0.273						
R3114x401A/C	3.9680	4.0320	3.9400	4.0600	0.160	0.280						
R3114x411A/C	4.0672	4.1328	4.0385	4.1615	0.164	0.287						
R3114x421A/C	4.1664	4.2336	4.1370	4.2630	0.168	0.294						
R3114x431A/C	4.2656	4.3344	4.2355	4.3645	0.172	0.301						
R3114x441A/C	4.3648	4.4352	4.3340	4.4660	0.176	0.308						
R3114x451A/C	4.4640	4.5360	4.4325	4.5675	0.180	0.315						
R3114x461A/C	4.5632	4.6368	4.5310	4.6690	0.184	0.322						
R3114x471A/C	4.6624	4.7376	4.6295	4.7705	0.188	0.329						
R3114x481A/C	4.7616	4.8384	4.7280	4.8720	0.192	0.336						
R3114x491A/C	4.8608	4.9392	4.8265	4.9735	0.196	0.343						
R3114x501A/C	4.9600	5.0400	4.9250	5.0750	0.200	0.350						

*Note1) V_{DD} value when output voltage is equal or less than 0.1V. In the case of Nch Open Drain output type, the output pin is pulled up to 5.0V through 470kΩ resistor.

Nch Driver Output Current1		Nch Driver Output Current2		Pch Driver Output Current		Nch Driver Leakage Current		Detector Threshold Temperature Coefficient	Output Delay Time			
IOUT1 [μA]		IOUT2 [mA]		IOUT3 [mA]		ILEAK [nA]		Δ-VDET/ΔTopt [ppm/°C]	tPLH [μs]			
Cond.	Min.	Cond.	Min.	Cond.	Min.	Cond.	Max.	Typ.	Cond.	Typ.		
VDD= 0.55V VDS= 0.05V	7	VDD= 0.6V VDS= 0.5V	0.020					±30	VDD= 0.55V ↓ -VDET +2.0V *Note2	40		
		VDD= 1.0V VDS= 0.5V	0.400									
		VDD= 1.5V VDS= 0.5V	1.000								VDD= 4.5V VDS= -2.1V	0.650
		VDD= 3.0V VDS= 0.5V	2.400								VDD= 6.0V VDS= -2.1V	0.900
						VDD= 6.0V VDS= 7.0V	80		VDD= 0.55V ↓ 6.0V *Note2			

*Note2) 1. In the case of CMOS output type:

When the voltage is forced from 0.55V to (-VDET)+2.0V or a 6.0V pulse voltage is added to VDD, time interval that the output voltage reaches ((-VDET)+2.0V)/2 or a 3.0V.

2. In the case of Nch Open Drain output type:

The output pin is pulled up to 5.0V through 470kΩ, and when the voltage is forced from 0.55V to (-VDET)+2.0V or a 6.0V pulse voltage is added to VDD, time interval that the output voltage reaches 2.5V.

OPERATION

• Operation of R3114xxx1A



OUT pin should be pulled-up to V_{DD} or an external voltage level.

Block Diagram (R3114xxx1A)



Step	1	2	3	4	5
Comparator (-) Pin Input Voltage	I	II	II	II	I
Comparator Output	L	H	Indefinite	H	L
Tr.1	OFF	ON	Indefinite	ON	OFF
Output Tr. Nch	OFF	ON	Indefinite	ON	OFF

$$I \quad \frac{R_b + R_c}{R_a + R_b + R_c} \times V_{DD}$$

$$II \quad \frac{R_b}{R_a + R_b} \times V_{DD}$$

Operation Diagram

• Explanation of operation

Step 1. The output voltage is equal to the pull-up voltage.

Step 2. At Point "A", $V_{ref} \geq V_{DD} \times (R_b + R_c) / (R_a + R_b + R_c)$ is true, as a result, the output of comparator is reversed from "L" to "H", therefore the output voltage becomes the GND level. The voltage level of Point A means a detector threshold voltage ($-V_{DET}$).

Step 3. When the supply voltage is lower than the minimum operating voltage, the operation of the output transistor becomes indefinite. The output voltage is equal to the pull-up voltage.

Step 4. The output voltage is equal to the GND level.

Step 5. At Point "B", $V_{ref} \leq V_{DD} \times R_b / (R_a + R_b)$ is true, as a result, the output of comparator is reversed from "H" to "L", then the output voltage is equal to the pull-up voltage. The voltage level of Point B means a released voltage ($+V_{DET}$).

*) The difference between a released voltage and a detector threshold voltage is a detector threshold hysteresis.

• Operation of R3114xxx1C



Block Diagram (R3114xxx1C)



Step	1	2	3	4	5
Comparator (-) Pin Input Voltage	I	II	II	II	I
Comparator Output	L	H	Indefinite	H	L
Tr.1	OFF	ON	Indefinite	ON	OFF
Output Tr.	Pch	ON	OFF	Indefinite	OFF
	Nch	OFF	ON	Indefinite	ON

$$I \quad \frac{Rb+Rc}{Ra+Rb+Rc} \times V_{DD}$$

$$II \quad \frac{Rb}{Ra+Rb} \times V_{DD}$$

Operation Diagram

• Explanation of operation

Step 1. The output voltage is equal to the supply voltage (V_{DD}).

Step 2. At Point "A", $V_{ref} \geq V_{DD} \times (Rb+Rc) / (Ra+Rb+Rc)$ is true, as a result, the output of comparator is reversed from "L" to "H", therefore the output voltage becomes the GND level. The voltage level of Point A means a detector threshold voltage ($-V_{DET}$).

Step 3. When the supply voltage is lower than the minimum operating voltage, the operation of the output transistor becomes indefinite.

Step 4. The output voltage is equal to the GND level.

Step 5. At Point "B", $V_{ref} \leq V_{DD} \times Rb / (Ra+Rb)$ is true, as a result, the output of comparator is reversed from "H" to "L", then the output voltage is equal to the supply voltage (V_{DD}). The voltage level of Point B means a released voltage ($+V_{DET}$).

*) The difference between a released voltage and a detector threshold voltage is a detector threshold hysteresis.

Detector Operation vs. glitch input voltage to the V_{DD} pin

When the R3114x is at released, if the pulse voltage which the detector threshold or lower voltage, the graph below means that the relation between pulse width and the amplitude of the swing to keep the released state for the R3114x.



*V_{OD}: Over Drive Voltage

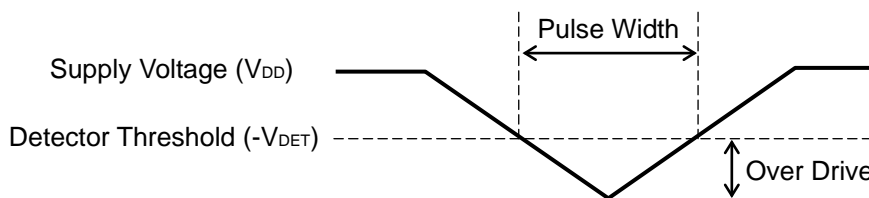

V_{DD} Input Waveform

This graph shows the maximum pulse conditions to keep the released voltage. If the pulse with larger amplitude or wider width than the graph above, is input to V_{DD} pin, the reset signal may be output.

TEST CIRCUITS



Supply Current Test Circuit



Detector Threshold Test Circuit
(Pull-up circuit is not necessary for CMOS Output type.)



Nch Driver Output Current Test Circuit



Pch Driver Output Current Test Circuit
*Apply to CMOS Output type only

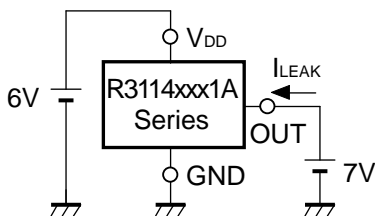

Nch Driver Leakage Current Test Circuit
*Apply to Nch Driver Output type only

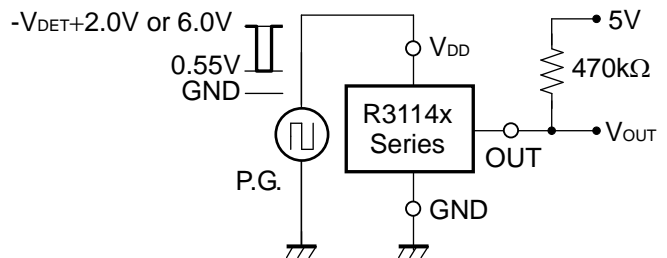

Output Delay Time Test Circuit
(Pull-up circuit is not necessary for CMOS Output type.)

TYPICAL CHARACTERISTICS

1) Supply Current vs. Input Voltage



2) Detector Threshold vs. Temperature



R3114x271A/C



R3114x451A/C



3) Output Voltage vs. Input Voltage

R3114x071C



R3114x151C



R3114x271C



R3114x451C



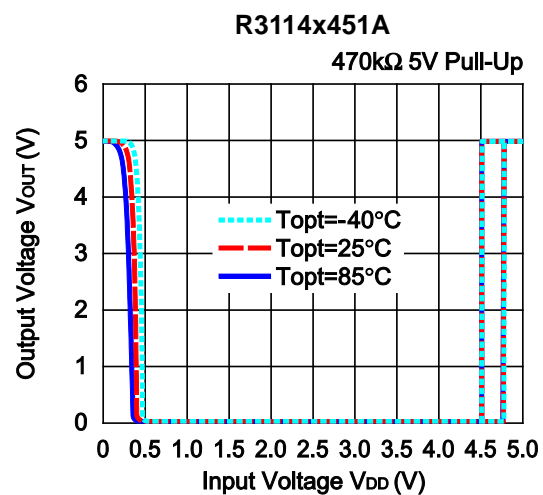
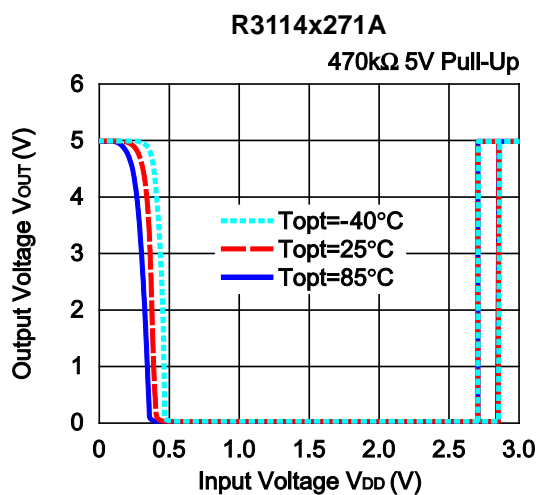
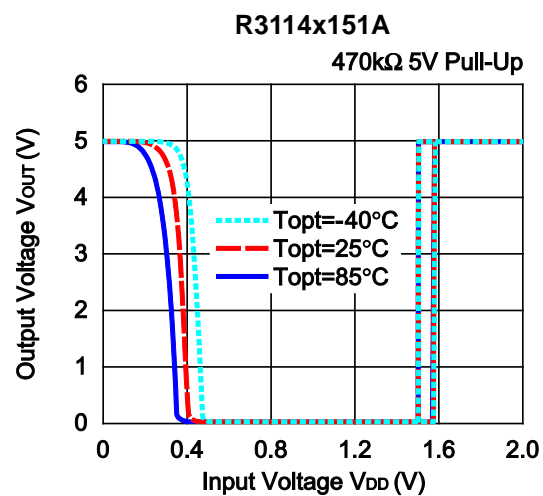
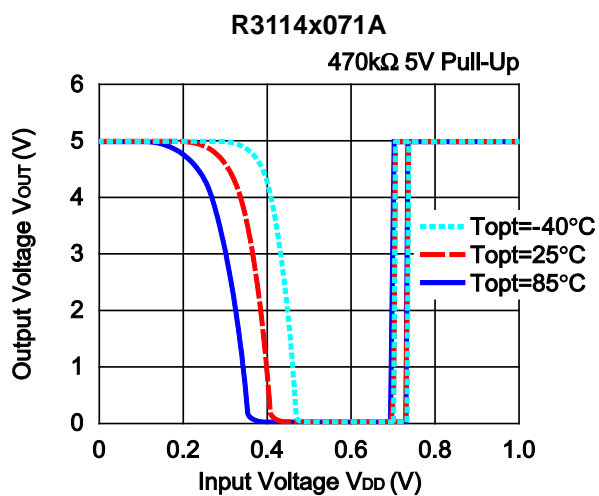

4) Nch Driver Output Current vs. Input Voltage ($V_{DS}=0.5\text{V}$)

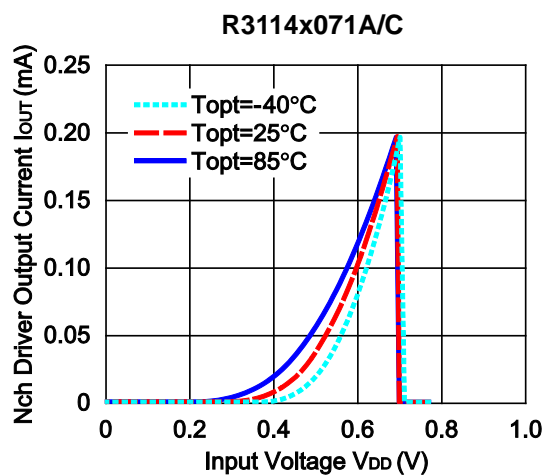



5) Nch Driver Output Current vs. V_{DS}



6) Pch Driver Output Current vs. Input Voltage ($V_{DS}=-2.1V$)7) Pch Driver Output Current vs. V_{DS} 

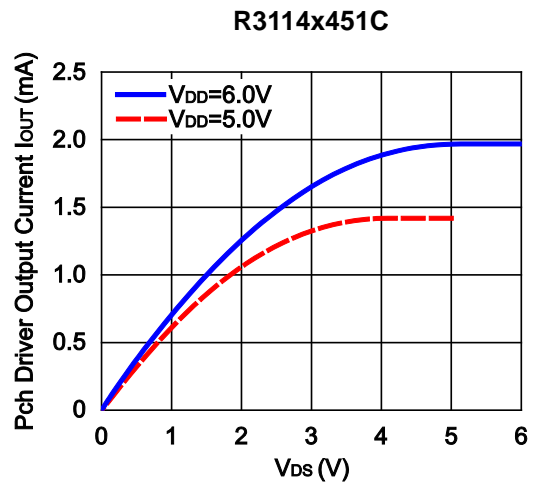

8) Output Delay Time vs. External Capacitance

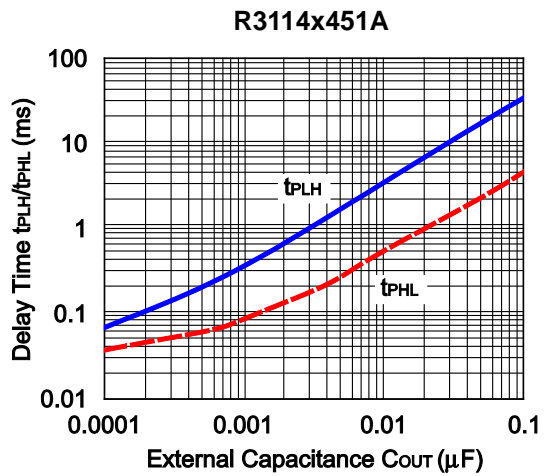
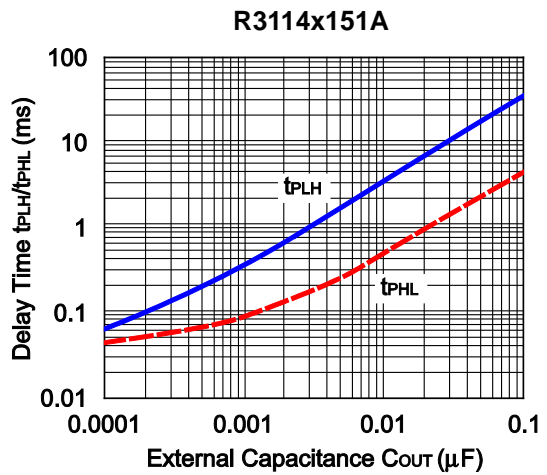

TYPICAL APPLICATION

• R3114xxx1A CPU Reset Circuit 1 (Nch Open Drain Output)

Case1. Input Voltage to R3114xxx1A is equal to Input Voltage to CPU



Case2. Input Voltage to R3114xxx1A is unequal to Input Voltage to CPU



• R3114xxx1C CPU Reset Circuit (CMOS Output)



• R3114xxx1A Output Delay Time Circuit 1 (Nch Open Drain Output)



• R3114xxx1A Output Delay Time Circuit 2 (Nch Open Drain Output)



• Memory Back-up Circuit



• **Voltage level Indicator Circuit (lighted when the power runs out)
(Nch Open Drain Output)**



• **Detector Threshold Adjustable Circuit 1
(Nch Open Drain Output)**



$$\text{Adjustable Detector Threshold} = (-V_{\text{DET}}) \times (R_a + R_b) / R_b$$

$$\text{Hysteresis Voltage} = (V_{\text{HYS}}) \times (R_a + R_b) / R_b$$

- *1) To prevent oscillation, set $R_a \leq 1\text{k}\Omega$, $R_b \leq 100\Omega$.
- *2) If the value of Ra is set excessively large, voltage drop may occur caused by the supply current of IC itself, and detector threshold and hysteresis voltage may vary.
- *3) If Vup and VDD are connected, the voltage dropdown caused by Rup, may cause difference in the hysteresis voltage.

• **Detector Threshold Adjustable Circuit 2
(Nch Open Drain Output)**



$$\text{Adjustable Detector Threshold} = (-V_{\text{DET}}) \times (R_a + R_b) / R_b$$

$$\text{Hysteresis Voltage} = (V_{\text{HYS}}) \times (R_a + R_b) / R_b$$

- *1) To prevent oscillation, set $R_a \leq 100\text{k}\Omega$, $C \geq \leq 0.01\mu\text{F}$.
- *2) If the value of Ra is set excessively large, voltage drop may occur caused by the supply current of IC itself, and detector threshold and hysteresis voltage may vary.
- *3) If Vup and VDD are connected, the voltage dropdown caused by Rup, may cause difference in the hysteresis voltage.
- *4) If the value of Ra, Rb and C are set excessively large, the delay of the start-up may become too long.

- **Window Comparator Circuit (Nch Open Drain Output)**

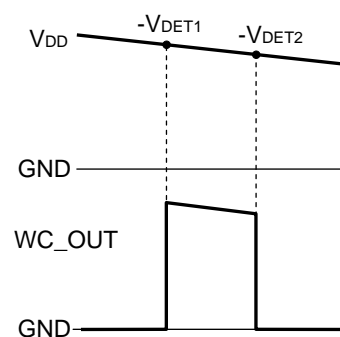

- **Over-charge Preventing Circuit**



TECHNICAL NOTES

When connecting resistors to the device's input pin

When connecting a resistor (R1) to an input of this device, the input voltage decreases by [Device's Consumption Current] x [Resistance Value] only. And, the cross conduction current*¹, which occurs when changing from the detecting state to the release state, is decreased the input voltage by [Cross Conduction Current] x [Resistance Value] only. And then, this device will enter the re-detecting state if the input voltage reduction is larger than the difference between the detector voltage and the released voltage.

When the input resistance value is large and the VDD is gone up at mildly in the vicinity of the released voltage, repeating the above operation may result in the occurrence of output.

As shown in Figure A/B, set R1 to become 100 kΩ or less as a guide, and connect C_{IN} of 0.1 μF and more to between the input pin and GND. Besides, make evaluations including temperature properties under the actual usage condition, with using the evaluation board like this way. As a result, make sure that the cross conduction current has no problem.

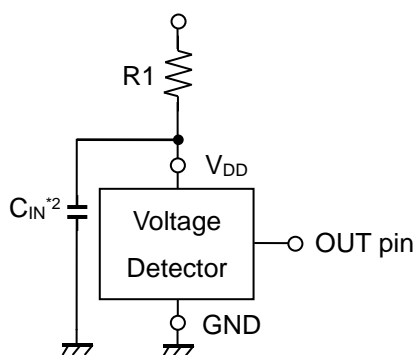

Figure A

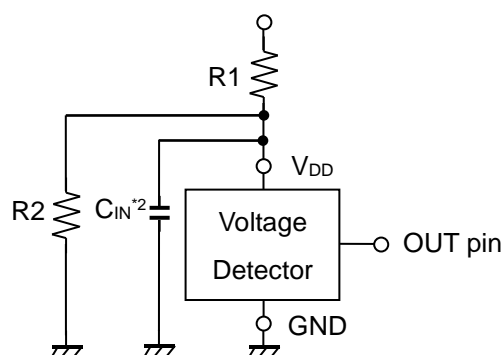

Figure B

*¹ In the CMOS output type, a charging current for OUT pin is included.

*² Note the bias dependence of capacitors.



1. The products and the product specifications described in this document are subject to change or discontinuation of production without notice for reasons such as improvement. Therefore, before deciding to use the products, please refer to Ricoh sales representatives for the latest information thereon.
2. The materials in this document may not be copied or otherwise reproduced in whole or in part without prior written consent of Ricoh.
3. Please be sure to take any necessary formalities under relevant laws or regulations before exporting or otherwise taking out of your country the products or the technical information described herein.
4. The technical information described in this document shows typical characteristics of and example application circuits for the products. The release of such information is not to be construed as a warranty of or a grant of license under Ricoh's or any third party's intellectual property rights or any other rights.
5. The products listed in this document are intended and designed for use as general electronic components in standard applications (office equipment, telecommunication equipment, measuring instruments, consumer electronic products, amusement equipment etc.). Those customers intending to use a product in an application requiring extreme quality and reliability, for example, in a highly specific application where the failure or misoperation of the product could result in human injury or death (aircraft, spacevehicle, nuclear reactor control system, traffic control system, automotive and transportation equipment, combustion equipment, safety devices, life support system etc.) should first contact us.
6. We are making our continuous effort to improve the quality and reliability of our products, but semiconductor products are likely to fail with certain probability. In order to prevent any injury to persons or damages to property resulting from such failure, customers should be careful enough to incorporate safety measures in their design, such as redundancy feature, fire containment feature and fail-safe feature. We do not assume any liability or responsibility for any loss or damage arising from misuse or inappropriate use of the products.
7. Anti-radiation design is not implemented in the products described in this document.
8. Please contact Ricoh sales representatives should you have any questions or comments concerning the products or the technical information.



Ricoh is committed to reducing the environmental loading materials in electrical devices with a view to contributing to the protection of human health and the environment.

Ricoh has been providing RoHS compliant products since April 1, 2006 and Halogen-free products since April 1, 2012.

RICOH RICOH ELECTRONIC DEVICES CO., LTD.

<http://www.e-devices.ricoh.co.jp/en/>

Sales & Support Offices

RICOH ELECTRONIC DEVICES CO., LTD.

Higashi-Shinagawa Office (International Sales)
3-32-3, Higashi-Shinagawa, Shinagawa-ku, Tokyo 140-8655, Japan
Phone: +81-3-5479-2857 Fax: +81-3-5479-0502

RICOH EUROPE (NETHERLANDS) B.V.

Semiconductor Support Centre
Prof. W.H. Keesomlaan 1, 1183 DJ Amstelveen, The Netherlands
Phone: +31-20-5474-309

RICOH INTERNATIONAL B.V. - German Branch

Semiconductor Sales and Support Centre
Oberrather Strasse 6, 40472 Düsseldorf, Germany
Phone: +49-211-6546-0

RICOH ELECTRONIC DEVICES KOREA CO., LTD.

3F, Haesung Bldg, 504, Teheran-ro, Gangnam-gu, Seoul, 135-725, Korea
Phone: +82-2-2135-5700 Fax: +82-2-2051-5713

RICOH ELECTRONIC DEVICES SHANGHAI CO., LTD.

Room 403, No.2 Building, No.690 Bibo Road, Pu Dong New District, Shanghai 201203, People's Republic of China
Phone: +86-21-5027-3200 Fax: +86-21-5027-3299

RICOH ELECTRONIC DEVICES CO., LTD.

Taipei office
Room 109, 10F-1, No.51, Hengyang Rd., Taipei City, Taiwan (R.O.C.)
Phone: +886-2-2313-1621/1622 Fax: +886-2-2313-1623

Mouser Electronics

Authorized Distributor

Click to View Pricing, Inventory, Delivery & Lifecycle Information:

Ricoh Electronics:

[R3114N281A-TR-FE](#) [R3114Q201A-TR-FE](#) [R3114K271A-TR](#) [R3114K071A-TR](#) [R3114Q461C-TR-FE](#) [R3114K301A-TR](#) [R3114K241C-TR](#) [R3114Q261C-TR-FE](#) [R3114Q221C-TR-FE](#) [R3114N201A-TR-FE](#) [R3114N191A-TR-FE](#) [R3114Q461A-TR-FE](#) [R3114K201A-TR](#) [R3114K311C-TR](#) [R3114Q181C-TR-FE](#) [R3114Q381A-TR-FE](#) [R3114K291A-TR](#) [R3114Q211A-TR-FE](#) [R3114K161A-TR](#) [R3114K171A-TR](#)

Компания «Океан Электроники» предлагает заключение долгосрочных отношений при поставках импортных электронных компонентов на взаимовыгодных условиях!

Наши преимущества:

- Поставка оригинальных импортных электронных компонентов напрямую с производств Америки, Европы и Азии, а так же с крупнейших складов мира;
- Широкая линейка поставок активных и пассивных импортных электронных компонентов (более 30 млн. наименований);
- Поставка сложных, дефицитных, либо снятых с производства позиций;
- Оперативные сроки поставки под заказ (от 5 рабочих дней);
- Экспресс доставка в любую точку России;
- Помощь Конструкторского Отдела и консультации квалифицированных инженеров;
- Техническая поддержка проекта, помощь в подборе аналогов, поставка прототипов;
- Поставка электронных компонентов под контролем ВП;
- Система менеджмента качества сертифицирована по Международному стандарту ISO 9001;
- При необходимости вся продукция военного и аэрокосмического назначения проходит испытания и сертификацию в лаборатории (по согласованию с заказчиком);
- Поставка специализированных компонентов военного и аэрокосмического уровня качества (Xilinx, Altera, Analog Devices, Intersil, Interpoint, Microsemi, Actel, Aeroflex, Peregrine, VPT, Syfer, Eurofarad, Texas Instruments, MS Kennedy, Miteq, Cobham, E2V, MA-COM, Hittite, Mini-Circuits, General Dynamics и др.);

Компания «Океан Электроники» является официальным дистрибьютором и эксклюзивным представителем в России одного из крупнейших производителей разъемов военного и аэрокосмического назначения «JONHON», а так же официальным дистрибьютором и эксклюзивным представителем в России производителя высокотехнологичных и надежных решений для передачи СВЧ сигналов «FORSTAR».



JONHON

«JONHON» (основан в 1970 г.)

Разъемы специального, военного и аэрокосмического назначения:

(Применяются в военной, авиационной, аэрокосмической, морской, железнодорожной, горно- и нефтедобывающей отраслях промышленности)

«FORSTAR» (основан в 1998 г.)

ВЧ соединители, коаксиальные кабели, кабельные сборки и микроволновые компоненты:

(Применяются в телекоммуникациях гражданского и специального назначения, в средствах связи, РЛС, а так же военной, авиационной и аэрокосмической отраслях промышленности).



Телефон: 8 (812) 309-75-97 (многоканальный)

Факс: 8 (812) 320-03-32

Электронная почта: ocean@oceanchips.ru

Web: <http://oceanchips.ru/>

Адрес: 198099, г. Санкт-Петербург, ул. Калинина, д. 2, корп. 4, лит. А