

3 V, SUPER MINIMOLD MEDIUM POWER SI MMIC AMPLIFIER

FEATURES

- **HIGH P_{1dB}**: 7 dBm TYP at 1.9 GHz
- **LOW VOLTAGE**: 3.0 V TYP, 2.7 V MIN
- **WIDE BANDWIDTH**: 2.9 GHz at -3 dB
- **SUPER SMALL PACKAGE**: SOT-363 package
- **TAPE AND REEL PACKAGING OPTION AVAILABLE**

DESCRIPTION

The UPC2762TB is a Silicon Monolithic integrated circuit which is manufactured using the NESAT™ III process. The NESAT™ III process produces transistors with f_t approaching 20 GHz. The UPC2762TB is pin compatible and has comparable performance to the larger UPC2762T, so it is suitable for use as a replacement to help reduce system size. The IC is housed in a 6 pin super minimold or SOT-363 package. Operating on a 3 volt supply, this IC is ideally suited for hand-held, portable designs.

Stringent quality assurance and test procedures ensure the highest reliability and performance.

ELECTRICAL CHARACTERISTICS (T_A = 25°C, Z_L = Z_S = 50Ω, V_{CC} = 3.0 V)

PART NUMBER PACKAGE OUTLINE			UPC2762TB S06		
SYMBOLS	PARAMETERS AND CONDITIONS	UNITS	MIN	TYP	MAX
I _{CC}	Circuit Current (no signal)	mA		27	35
G _S	Small Signal Gain, f = 900 MHz f = 1900 MHz	dB dB	11 11.5	13 15.5	16 17.5
f _U	Upper Limit Operating Frequency (The gain at f _U is 3 dB down from the gain at 0.1 GHz)	GHz	2.7	2.9	
P _{1dB}	Output Power at 1 dB Compression Point, f = 900 MHz f = 1900 MHz	dBm dBm	+5.5 +4.5	+8 +7	
P _{SAT}	Saturated Output Power, f = 900 MHz f = 1900 MHz	dBm dBm		9 8.5	
NF	Noise Figure, f = 900 MHz f = 1900 MHz	dB dB		6.5 7	8.0 9.0
RL _{IN}	Input Return Loss, f = 900 MHz f = 1900 MHz	dB dB	6 5.5	9 8.5	
RL _{OUT}	Output Return Loss, f = 900 MHz f = 1900 MHz	dB dB	8 9	11 12	
ISOL	Isolation, f = 900 MHz f = 1900 MHz	dB dB	22 20	27 25	
OIP ₃	SSB Output Third Order Intercept Point P _{OUT} = +4 dBm	dBm dBm		+12 +9	
P _{ADJ}	Adjacent Channel Power, f = 900 MHz, π/4 QPSK wave ¹ , P _O = +4 dBm	dBc dBc		-64 -64	

Note:

1. π/4 QPSK modulated wave input, data rate 42 kbps.

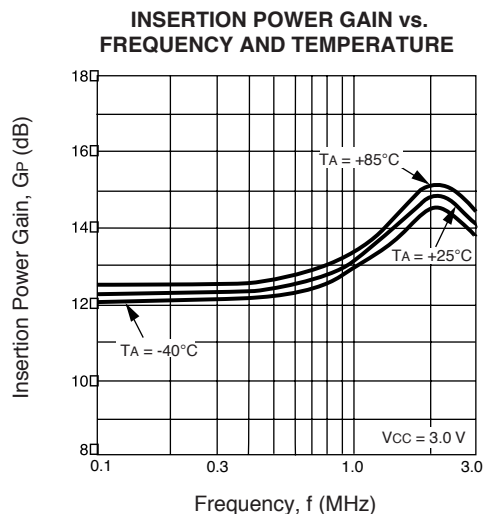

ABSOLUTE MAXIMUM RATINGS¹ (T_A = 25°C)

SYMBOLS	PARAMETERS	UNITS	RATINGS
V _{CC}	Supply Voltage	V	3.6
I _{CC}	Total Supply Current	mA	70
P _{IN}	Input Power	dBm	+10
P _T	Total Power Dissipation ²	mW	200
T _{OP}	Operating Temperature	°C	-40 to +85
T _{STG}	Storage Temperature	°C	-55 to +150

Notes:

1. Operation in excess of any one of these parameters may result in permanent damage.
2. Mounted on a 50 x 50 x 1.6 mm epoxy glass PWB (T_A = 85°C).

RECOMMENDED OPERATING CONDITIONS

SYMBOLS	PARAMETERS	UNITS	MIN	TYP	MAX
V _{CC}	Supply Voltage	V	2.7	3	3.3
T _{OP}	Operating Temperature	°C	-40	25	85

TEST CIRCUIT

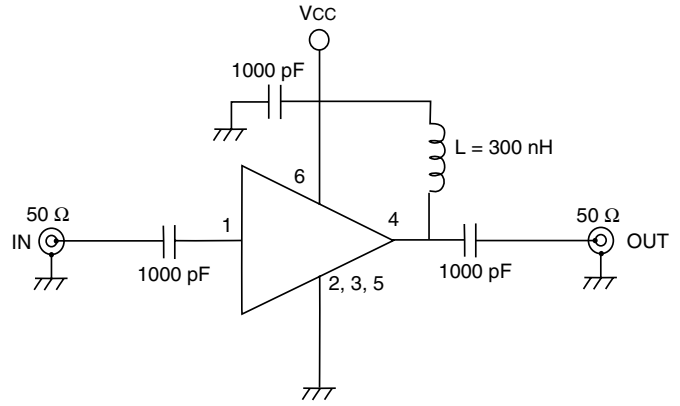

TYPICAL PERFORMANCE CURVES (T_A = 25°C)

CIRCUIT CURRENT vs. SUPPLY VOLTAGE

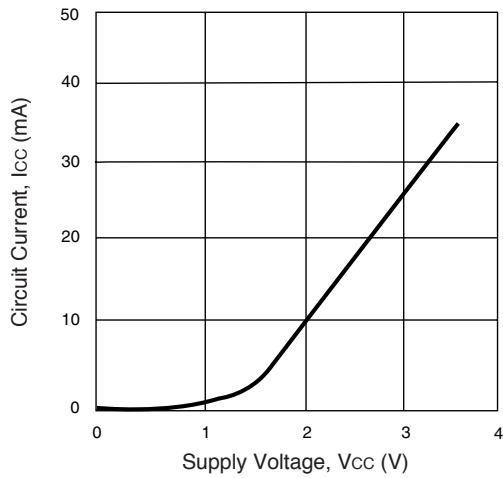

CIRCUIT CURRENT vs. OPERATING TEMPERATURE

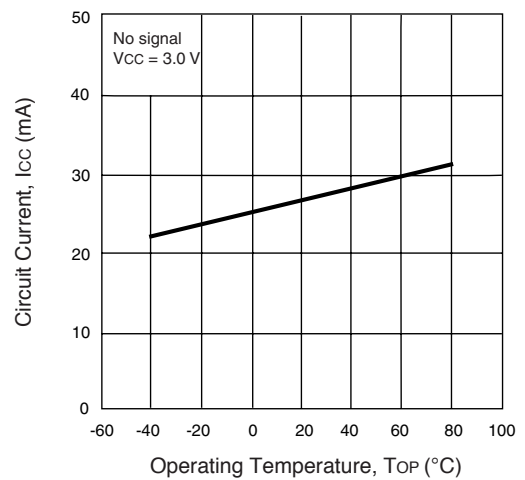

NOISE FIGURE AND INSERTION POWER GAIN vs. FREQUENCY AND VOLTAGE

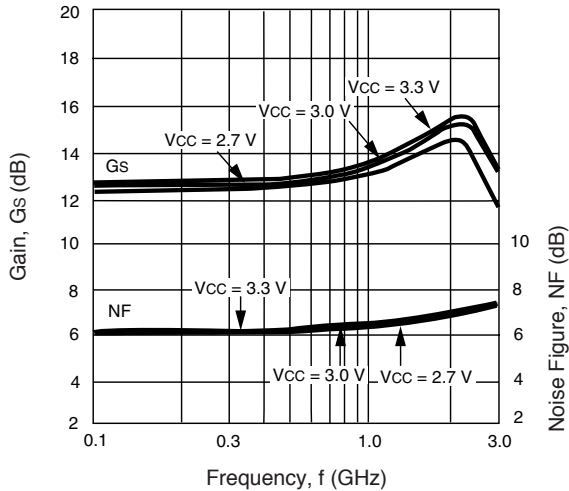

INPUT AND OUTPUT RETURN LOSS vs. FREQUENCY

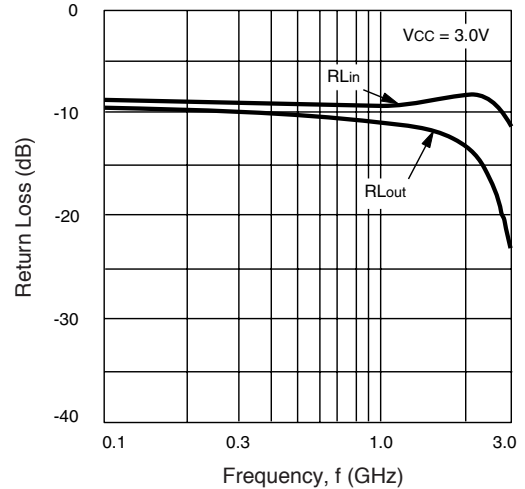

TYPICAL PERFORMANCE CURVES (TA = 25°C)

ISOLATION vs. FREQUENCY

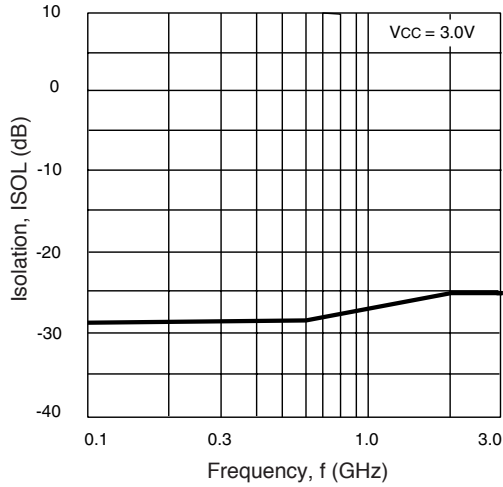

OUTPUT POWER vs. INPUT POWER AND VOLTAGE

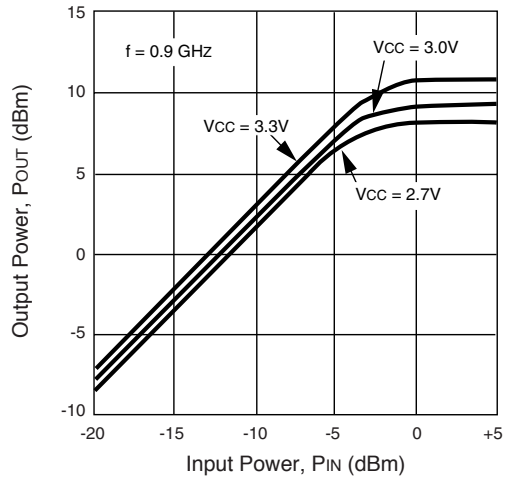

OUTPUT POWER vs. INPUT POWER AND TEMPERATURE

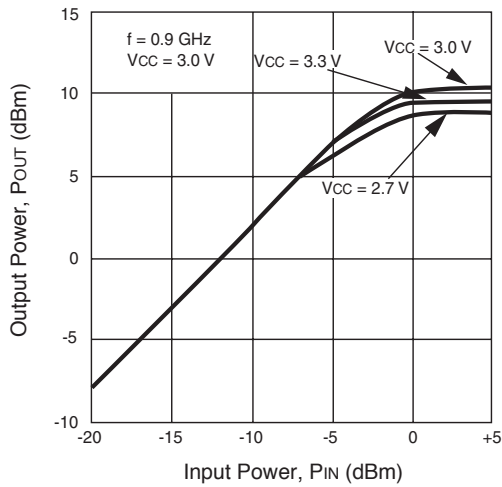

OUTPUT POWER vs. INPUT POWER AND VOLTAGE

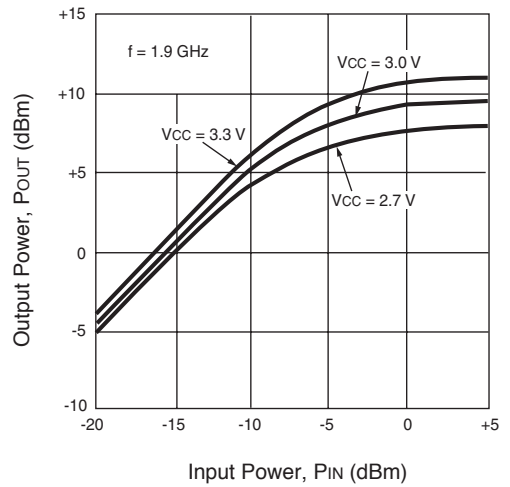

OUTPUT POWER vs. INPUT POWER AND TEMPERATURE

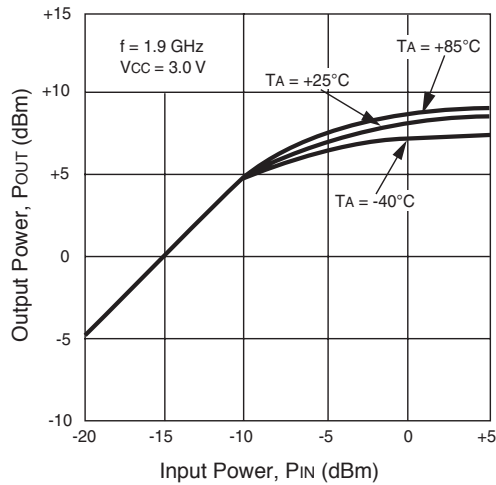

SATURATED OUTPUT POWER vs. FREQUENCY

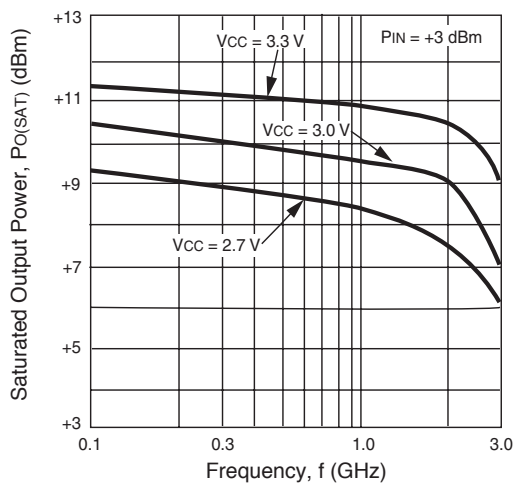

TYPICAL PERFORMANCE CURVES ($T_A = 25^\circ\text{C}$)

SATURATED OUTPUT POWER vs. FREQUENCY AND TEMPERATURE

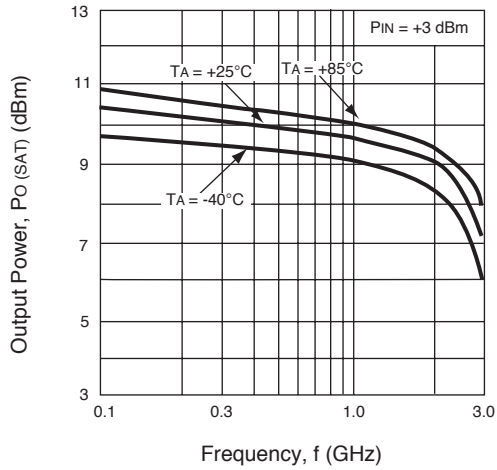

THIRD ORDER INTERMODULATION DISTORTION vs. OUTPUT POWER OF EACH TONE AND VOLTAGE

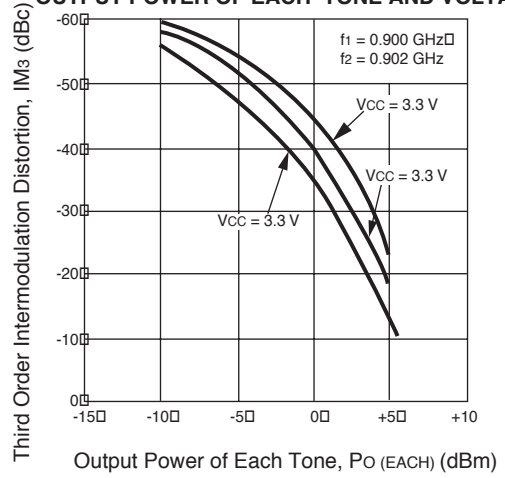

THIRD ORDER INTERMODULATION DISTORTION vs. OUTPUT POWER OF EACH TONE AND VOLTAGE

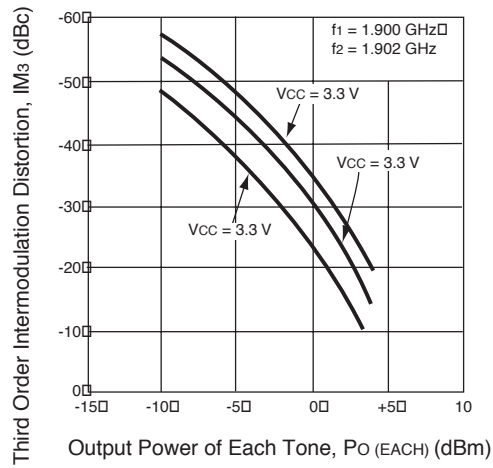

TYPICAL SCATTERING PARAMETERS ($T_A = +25^\circ\text{C}$, $V_{CC} = V_{OUT} = 3.0\text{ V}$)

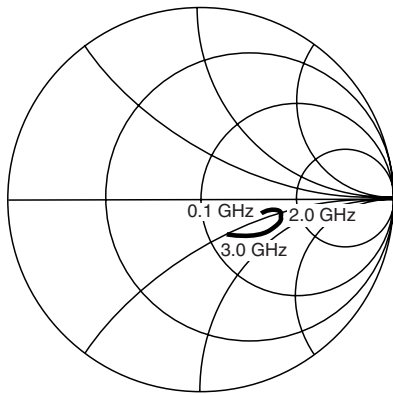

S11

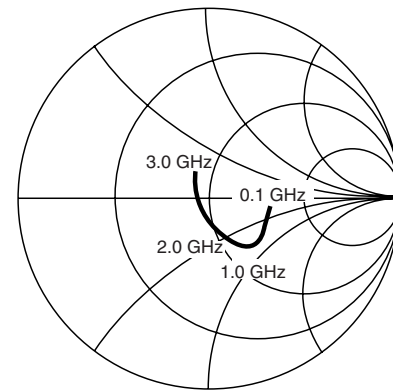

S22

$V_{CC} = V_{OUT} = 3.0\text{ V}$, $I_{CC} = 29\text{ mA}$

FREQUENCY GHz	S11		S21		S12		S22		K
	MAG	ANG	MAG	ANG	MAG	ANG	MAG	ANG	
0.1	0.338	-1.3	4.560	-3.4	0.039	1.0	0.310	-5.5	2.23
0.2	0.346	-2.0	4.581	-7.6	0.039	2.7	0.311	-9.5	2.20
0.3	0.348	-1.2	4.616	-11.3	0.039	6.8	0.302	-12.3	2.20
0.4	0.340	-1.9	4.661	-15.8	0.040	8.1	0.296	-16.2	2.18
0.5	0.329	-3.1	4.689	-19.5	0.040	11.6	0.290	-20.2	2.20
0.6	0.324	-6.2	4.726	-23.6	0.041	13.7	0.292	-24.1	2.12
0.7	0.341	-8.1	4.844	-27.4	0.042	15.8	0.291	-26.2	2.01
0.8	0.359	-7.6	4.927	-31.5	0.043	18.1	0.292	-28.3	1.90
0.9	0.378	-6.5	5.057	-35.8	0.044	19.3	0.284	-30.9	1.77
1.0	0.375	-5.1	5.179	-41.0	0.045	20.3	0.280	-35.3	1.72
1.1	0.363	-5.2	5.306	-45.9	0.047	22.1	0.285	-40.0	1.64
1.2	0.353	-6.7	5.400	-51.0	0.047	23.7	0.288	-43.4	1.62
1.3	0.357	-8.8	5.567	-56.5	0.048	26.1	0.288	-45.7	1.54
1.4	0.377	-11.7	5.706	-61.7	0.049	24.5	0.285	-47.9	1.44
1.5	0.402	-12.7	5.820	-68.0	0.052	26.7	0.282	-52.8	1.32
1.6	0.414	-13.2	5.987	-73.7	0.052	26.8	0.285	-58.1	1.27
1.7	0.426	-13.6	6.081	-80.1	0.055	29.0	0.288	-62.0	1.18
1.8	0.434	-16.1	6.182	-86.7	0.056	28.2	0.291	-66.1	1.14
1.9	0.448	-19.0	6.229	-93.2	0.057	28.5	0.286	-70.4	1.09
2.0	0.463	-21.7	6.328	-99.7	0.057	28.0	0.282	-76.2	1.07
2.1	0.483	-23.9	6.382	-106.7	0.058	28.5	0.282	-81.5	1.01
2.2	0.492	-25.8	6.431	-113.8	0.058	29.0	0.282	-86.9	0.99
2.3	0.492	-29.7	6.424	-121.2	0.060	30.1	0.278	-91.7	0.99
2.4	0.486	-34.6	6.329	-128.8	0.060	30.2	0.268	-98.4	1.01
2.5	0.489	-40.4	6.146	-136.1	0.062	31.1	0.260	-104.5	1.02
2.6	0.500	-44.6	5.997	-143.1	0.061	32.1	0.251	-111.3	1.05
2.7	0.511	-48.5	5.822	-149.9	0.064	31.4	0.248	-116.7	1.03
2.8	0.511	-50.4	5.693	-157.0	0.066	34.0	0.237	-121.5	1.04
2.9	0.494	-52.9	5.553	-163.0	0.065	33.8	0.222	-128.3	1.11
3.0	0.465	-55.9	5.334	-169.5	0.065	35.5	0.203	-134.5	1.20
3.1	0.441	-60.6	5.157	-175.5	0.066	35.5	0.189	-141.1	1.27

OUTLINE DIMENSIONS (Units in mm)

LEAD CONNECTIONS

PACKAGE OUTLINE S06

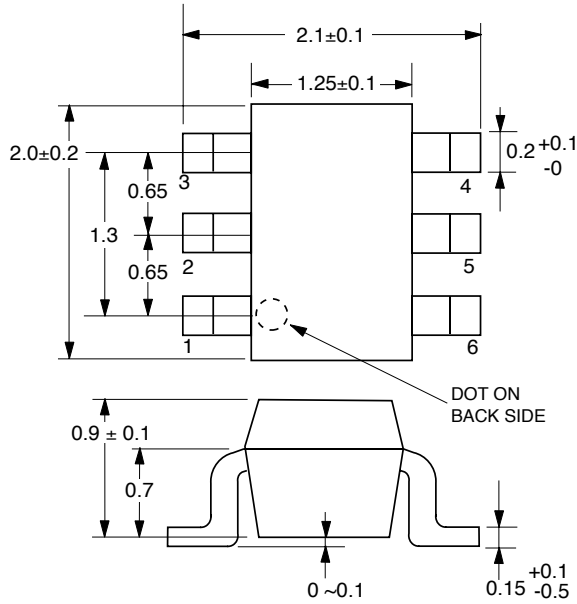

(Top View)

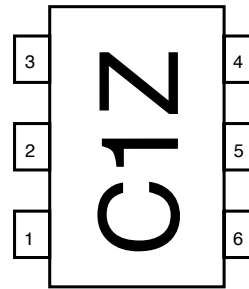

(Bottom View)

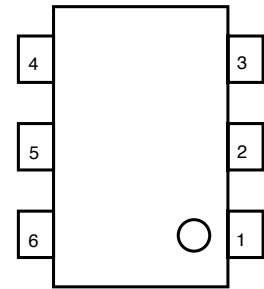

- 1. INPUT
- 2. GND
- 3. GND
- 4. OUTPUT
- 5. GND
- 6. Vcc

PIN DESCRIPTIONS

Pin No.	Pin Name	Applied Voltage (V)	Description	Internal Equivalent Circuit
1	Input	-	Signal input pin. An internal matching circuit, configured with resistors, enables 50 Ω connection over a wide bandwidth. A multi-feedback circuit is designed to cancel the deviations of hFE and resistance. This pin must be coupled to the signal source with a blocking capacitor.	
4	Output	2.7 to 3.3	Signal output pin. Connect an inductor between this pin and Vcc to supply current to the internal output transistors.	
6	Vcc		Power supply pin. This pin should be externally equipped with a bypass capacitor to minimize ground impedance.	
2 3 5	GND	0	Ground pins. These pins should be connected to system ground with minimum inductance. Ground pattern on the board should be formed as wide as possible. All the ground pins must be connected together with wide ground pattern to minimize impedance difference.	

ORDERING INFORMATION

PART NUMBER	QTY
UPC2762TB-E3-A	3K/Reel

Note:
Embossed Tape, 8 mm wide. Pins 1, 2 and 3 face perforated side

Компания «Океан Электроники» предлагает заключение долгосрочных отношений при поставках импортных электронных компонентов на взаимовыгодных условиях!

Наши преимущества:

- Поставка оригинальных импортных электронных компонентов напрямую с производств Америки, Европы и Азии, а так же с крупнейших складов мира;
- Широкая линейка поставок активных и пассивных импортных электронных компонентов (более 30 млн. наименований);
- Поставка сложных, дефицитных, либо снятых с производства позиций;
- Оперативные сроки поставки под заказ (от 5 рабочих дней);
- Экспресс доставка в любую точку России;
- Помощь Конструкторского Отдела и консультации квалифицированных инженеров;
- Техническая поддержка проекта, помощь в подборе аналогов, поставка прототипов;
- Поставка электронных компонентов под контролем ВП;
- Система менеджмента качества сертифицирована по Международному стандарту ISO 9001;
- При необходимости вся продукция военного и аэрокосмического назначения проходит испытания и сертификацию в лаборатории (по согласованию с заказчиком);
- Поставка специализированных компонентов военного и аэрокосмического уровня качества (Xilinx, Altera, Analog Devices, Intersil, Interpoint, Microsemi, Actel, Aeroflex, Peregrine, VPT, Syfer, Eurofarad, Texas Instruments, MS Kennedy, Miteq, Cobham, E2V, MA-COM, Hittite, Mini-Circuits, General Dynamics и др.);

Компания «Океан Электроники» является официальным дистрибьютором и эксклюзивным представителем в России одного из крупнейших производителей разъемов военного и аэрокосмического назначения «**JONHON**», а так же официальным дистрибьютором и эксклюзивным представителем в России производителя высокотехнологичных и надежных решений для передачи СВЧ сигналов «**FORSTAR**».



JONHON

«**JONHON**» (основан в 1970 г.)

Разъемы специального, военного и аэрокосмического назначения:

(Применяются в военной, авиационной, аэрокосмической, морской, железнодорожной, горно- и нефтедобывающей отраслях промышленности)

«**FORSTAR**» (основан в 1998 г.)

ВЧ соединители, коаксиальные кабели, кабельные сборки и микроволновые компоненты:

(Применяются в телекоммуникациях гражданского и специального назначения, в средствах связи, РЛС, а так же военной, авиационной и аэрокосмической отраслях промышленности).



Телефон: 8 (812) 309-75-97 (многоканальный)

Факс: 8 (812) 320-03-32

Электронная почта: ocean@oceanchips.ru

Web: <http://oceanchips.ru/>

Адрес: 198099, г. Санкт-Петербург, ул. Калинина, д. 2, корп. 4, лит. А