

Metallized Paper (MP) RFI-Capacitors Class Y2 with Internal Series Connection PCM 15 mm to 27.5 mm

Special Features

- Particularly high reliability against active and passive flammability
- Twice the safety by internal series connection
- High degree of interference suppression due to good attenuation and low ESR
- For temperatures up to +110° C
- According to RoHS 2011/65/EU

Typical Applications

Class Y2 RFI applications to meet EMC regulations

- Capacitors connected to the mains between phase or neutral and earthed casing
- By-passing of the basic or supplementary insulation, pulse peak voltage ≤ 5 kV

Construction

Dielectric:

Paper, epoxy resin impregnated

Capacitor electrodes:

Vacuum-deposited

Internal construction:

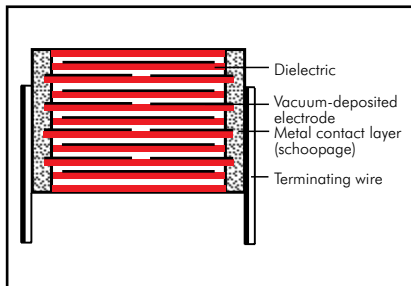

Encapsulation:

Self-extinguishing epoxy resin, UL 94 V-0, metal foil

Terminations:

Tinned wire.

Marking:

Marking: Black on Silver.

Electrical Data

Capacitance range:

1000 pF to 0.1 μ F (E12-values on request)

Rated voltage:

300 VAC

Continuous DC voltage* (general guide):

≤ 1250 V

Capacitance tolerances:

$\pm 20\%$

Operating temperature range:

-40° C to $+110^{\circ}$ C

Climatic test category:

40/110/56/B according to IEC

Insulation resistance at $+20^{\circ}$ C:

$\geq 12 \times 10^3$ M Ω

Measuring voltage: 100 V/1 min.



Dissipation factors:

$\tan \delta \leq 13 \times 10^{-3}$ at 1 kHz and $+20^{\circ}$ C

Test specifications:

In accordance with IEC 60384-14

Approvals:

Country	Authority	Specification	Symbol	Approval-No.
Germany	VDE	IEC 60384-14/3		40032534
USA/Canada	UL	UL 60384-14 CAN/CSA-E60384-14		E 134915

Maximum pulse rise time:

Capacitance pF/ μ F	Pulse rise time V/ μ sec max. operation
1000 ... 4700	2500
6800 ... 0.015	1850
0.022 ... 0.1	600

for pulses equal to a voltage amplitude with $\sqrt{2} \times 300$ VAC = 425 V according to IEC 60384-14

Test voltage: 3000 VDC, 2 sec.

Reliability:

Operational life > 300 000 hours

Failure rate < 1 fit ($0.5 \times U_r$ and 40° C)

Mounting Recommendation

To minimize or avoid shock and/or vibration stresses to terminating wires and solder connections we recommend to fix voluminous resin-potted MP capacitors as from e.g. PCM 22.5 mm in an appropriate way since for constructional reasons they do not sit tight on the board.

* If safety-approved EMI suppression capacitors are operated with a DC voltage being above the specified AC voltage rating the given approvals are no longer valid (IEC 60384-14).

Furthermore the permissible pulse rise time du/dt ($F_{max.}$) will be subject to a reduction according to

$$F_{max.} = F_r \times \sqrt{2} \times UAC / UDC$$

if the DC operating voltage UDC is higher than $\sqrt{2} \times UAC$

Packing

Available taped and reeled up to and including PCM 22.5 mm.

Detailed taping information and graphs at the end of the catalogue.

For further details and graphs please refer to Technical Information.

Continuation

General Data

Capacitance	300 VAC*				
	W	H	L	PCM**	Part number
1000 pF	5	13	19	15	MPLY2W1100FC00_____
1500 „	5	13	19	15	MPLY2W1150FC00_____
2200 „	5	13	19	15	MPLY2W1220FC00_____
3300 „	5	13	19	15	MPLY2W1330FC00_____
4700 „	6	14	19	15	MPLY2W1470FD00_____
6800 „	7	15	19	15	MPLY2W1680FE00_____
0.01 µF	8	17	19	15	MPLY2W2100FF00_____
0.015 „	10	18	19	15	MPLY2W2150FG00_____
0.022 „	8	20	28	22.5	MPLY2W2220FH00_____
0.033 „	8	20	28	22.5	MPLY2W2330FH00_____
0.047 „	10	22	28	22.5	MPLY2W2470FI00_____
0.068 „	12	24	28	22.5	MPLY2W2680FJ00_____
0.1 µF	13	25	33	27.5	MPLY2W3100FK00_____

* f = 50/60 Hz

** PCM = Printed circuit module = pin spacing

Upon request with long pins 35-2 mm max.

Dims. in mm.

Part number completion:
 Tolerance: 20 % = M
 Packing: bulk = S
 Pin length: 6-2 = SD
 Taped version see page 140.

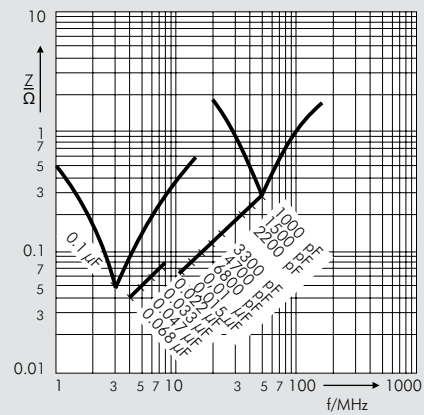
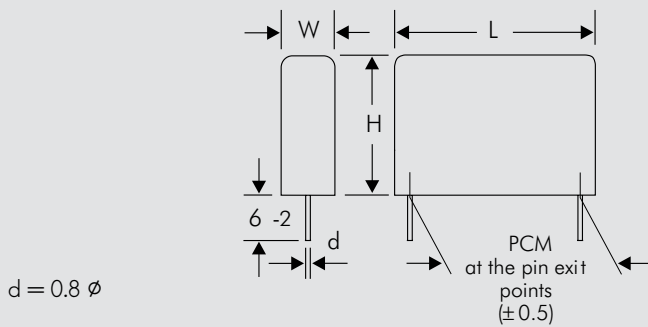

Rights reserved to amend design data without prior notification.

Recommendation for Processing and Application of Through-Hole Capacitors

Soldering Process

Internal temperature of the capacitor must be kept as follows:

Polyester: preheating: $T_{max.} \leq 125^{\circ}C$
soldering: $T_{max.} \leq 135^{\circ}C$

Polypropylene: preheating: $T_{max.} \leq 100^{\circ}C$
soldering: $T_{max.} \leq 110^{\circ}C$

Single wave soldering

Soldering bath temperature: $T < 260^{\circ}C$

Dwell time: $t < 5 \text{ sec}$

Double wave soldering

Soldering bath temperature: $T < 260^{\circ}C$

Dwell time: $\Sigma t < 5 \text{ sec}$

Due to different soldering processes and heat requirements the graphs are to be regarded as a recommendation only.

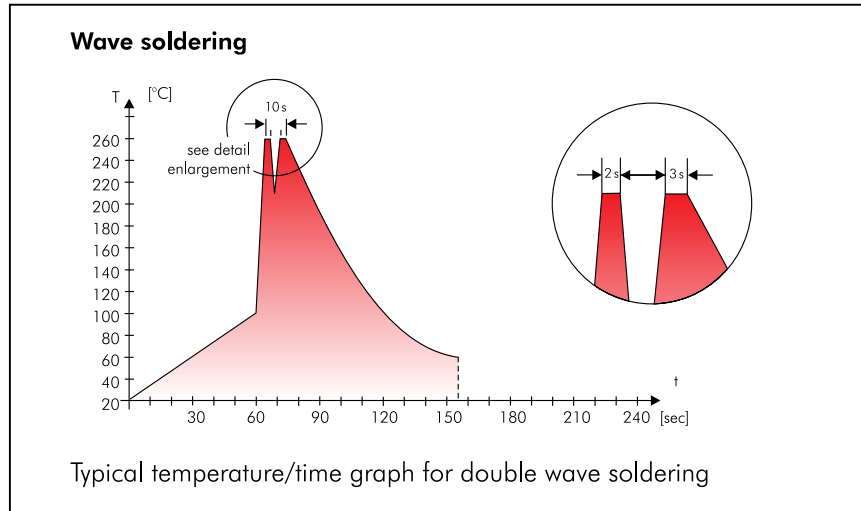

WIMA Quality and Environmental Philosophy

ISO 9001:2008 Certification

ISO 9001:2008 is an international basic standard of quality assurance systems for all branches of industry. The approval according to ISO 9001:2008 of our factories by the VDE inspectorate certifies that organisation, equipment and monitoring of quality assurance in our factories correspond to internationally recognized standards.

WIMA WPCS

The WIMA Process Control System (WPCS) is a quality surveillance and optimization system developed by WIMA. WPCS is a major part of the quality-oriented WIMA production. Points of application of WPCS during production process:

- incoming material inspection
- metallization
- film inspection
- schoopage
- pre-healing
- pin attachment
- cast resin preparation/encapsulation
- 100% final inspection
- Testing as per customer requirements

WIMA Environmental Policy

All WIMA capacitors, irrespective of whether through-hole devices or SMD, are made of environmentally friendly materials. Neither during manufacture nor in the product itself any toxic substances are used, e.g.

- Lead
- PCB
- CFC
- Hydrocarbon chloride
- Chromium 6+
- PBB/PBDE
- Arsenic
- Cadmium
- Mercury
- etc.

We merely use pure, recyclable materials for packing our components, such as:

- carton
- cardboard
- adhesive tape made of paper
- polystyrene

We almost completely refrain from using packing materials such as:

- foamed polystyrene (Styropor®)
- adhesive tapes made of plastic
- metal clips

RoHS Compliance

According to the RoHS Directive 2011/65/EU certain hazardous substances like e.g. lead, cadmium, mercury must not be used any longer in electronic equipment as of July 1st, 2006. For the sake of the environment WIMA has refrained from using such substances since years already.



WIMA Kondensatoren sind bleifrei konform RoHS 2011/65/EU

WIMA capacitors are lead free in accordance with RoHS 2011/65/EU

Tape for lead-free WIMA capacitors

DIN EN ISO 14001:2004

WIMA's environmental management has been established in accordance with the guidelines of DIN EN ISO 14001:2004 to optimize the production processes with regard to energy and resources.

Typical Dimensions for Taping Configuration

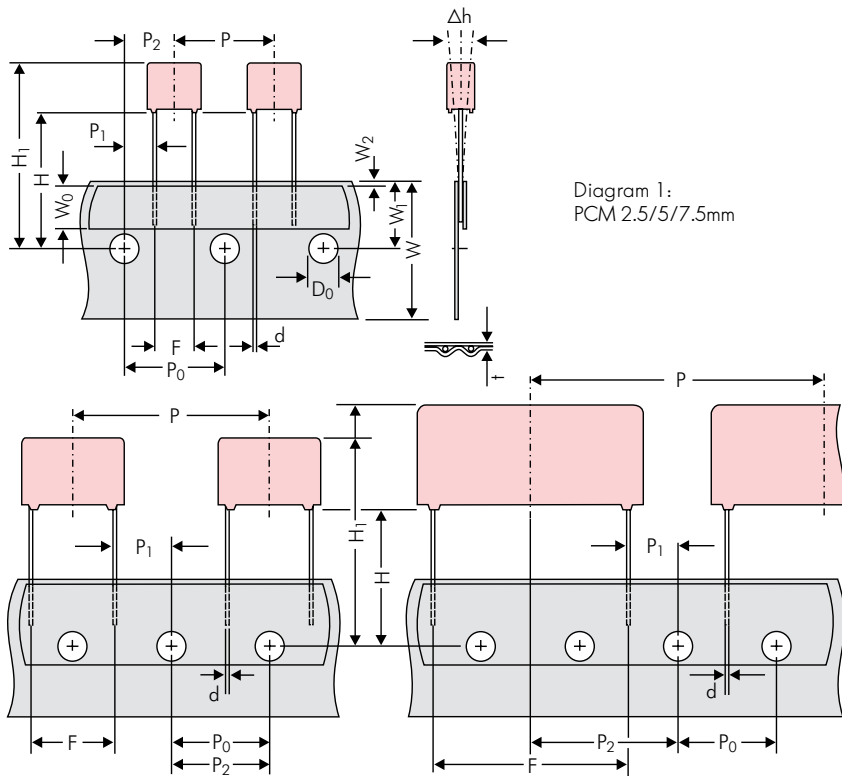

Diagram 2: PCM 10/15 mm

Diagram 3: PCM 22.5 and 27.5*mm

*PCM 27.5 tapping possible with two feed holes between components

Designation	Symbol	Dimensions for Radial Taping										
		PCM 2.5 tapping	PCM 5 tapping	PCM 7.5 tapping	PCM 10 tapping*	PCM 15 tapping*	PCM 22.5 tapping	PCM 27.5 tapping				
Carrier tape width	W	18.0 ±0.5	18.0 ±0.5	18.0 ±0.5	18.0 ±0.5	18.0 ±0.5	18.0 ±0.5	18.0 ±0.5				
Hold-down tape width	W ₀	6.0 for hot-sealing adhesive tape	6.0 for hot-sealing adhesive tape	12.0 for hot-sealing adhesive tape	12.0 for hot-sealing adhesive tape	12.0 for hot-sealing adhesive tape	12.0 for hot-sealing adhesive tape	12.0 for hot-sealing adhesive tape				
Hole position	W ₁	9.0 ±0.5	9.0 ±0.5	9.0 ±0.5	9.0 ±0.5	9.0 ±0.5	9.0 ±0.5	9.0 ±0.5				
Hold-down tape position	W ₂	0.5 to 3.0 max.	0.5 to 3.0 max.	0.5 to 3.0 max.	0.5 to 3.0 max.	0.5 to 3.0 max.	0.5 to 3.0 max.	0.5 to 3.0 max.				
Feed hole diameter	D ₀	4.0 ±0.2	4.0 ±0.2	4.0 ±0.2	4.0 ±0.2	4.0 ±0.2	4.0 ±0.2	4.0 ±0.2				
Pitch of component	P	12.7 ±1.0	12.7 ±1.0	12.7 ±1.0	25.4 ±1.0	25.4 ±1.0	38.1 ±1.5	38.1 ±1.5 or 50.8 ±1.5				
Feed hole pitch	P ₀	12.7 ±0.3 cumulative pitch error max. 1.0 mm/20 pitch	12.7 ±0.3 cumulative pitch error max. 1.0 mm/20 pitch	12.7 ±0.3 cumulative pitch error max. 1.0 mm/20 pitch	12.7 ±0.3 cumulative pitch error max. 1.0 mm/20 pitch	12.7 ±0.3 cumulative pitch error max. 1.0 mm/20 pitch	12.7 ±0.3 cumulative pitch error max. 1.0 mm/20 pitch	12.7 ±0.3 cumulative pitch error max. 1.0 mm/20 pitch				
Feed hole centre to pin	P ₁	5.1 ±0.5	3.85 ±0.7	2.6 ±0.7	7.7 ±0.7	5.2 ±0.7	7.8 ±0.7	5.3 ±0.7				
Hole centre to component centre	P ₂	6.35 ±1.3	6.35 ±1.3	6.35 ±1.3	12.7 ±1.3	12.7 ±1.3	19.05 ±1.3	19.05 ±1.3				
Feed hole centre to bottom edge of the component	H	16.5 ±0.3	16.5 ±0.3	16.5 ±0.5	16.5 ±0.5	16.5 ±0.5	16.5 ±0.5	16.5 ±0.5				
Feed hole centre to top edge of the component	H ₁	H+H _{component} < H ₁ 32.25 max.	H+H _{component} < H ₁ 32.25 max.	H+H _{component} < H ₁ 24.5 to 31.5	H+H _{component} < H ₁ 25.0 to 31.5	H+H _{component} < H ₁ 26.0 to 37.0	H+H _{component} < H ₁ 30.0 to 43.0	H+H _{component} < H ₁ 35.0 to 45.0				
Pin spacing at upper edge of carrier tape	F	2.5 ±0.5	5.0 ^{+0.8} _{-0.2}	7.5 ±0.8	10.0 ±0.8	15 ±0.8	22.5 ±0.8	27.5 ±0.8				
Pin diameter	d	0.4 ±0.05	0.5 ±0.05	0.5 ±0.05 or 0.6 ^{+0.06} _{-0.05}	0.5 ±0.05 or 0.6 ^{+0.06} _{-0.05}	0.8 ^{+0.08} _{-0.05}	0.8 ^{+0.08} _{-0.05}	0.8 ^{+0.08} _{-0.05}				
Component alignment	Δh	± 2.0 max.	± 2.0 max.	± 3.0 max.	± 3.0 max.	± 3.0 max.	± 3.0 max.	± 3.0 max.				
Total tape thickness	t	0.7 ±0.2	0.7 ±0.2	0.7 ±0.2	0.7 ±0.2	0.7 ±0.2	0.7 ±0.2	0.7 ±0.2				
Package (see also page 141)	ROLL/AMMO			AMMO								
	REEL	φ 360 max. φ 30 ±1	B 52 ±2 58 ±2	depending on comp. dimensions		REEL	φ 360 max. φ 30 ±1	B 52 ±2 58 ±2 or 66 ±2	REEL	φ 500 max. φ 25 ±1	B 60 ±2 68 ±2	depending on PCM and component dimensions
Unit	see details page 142.											

Dims in mm.

* Diameter of pins see General Data.

* PCM 10 and PCM 15 can be crimped to PCM 7.5.

Position of components according to PCM 7.5 (sketch 11). P₀ = 12.7 or 15.0 is possible

Please clarify customer-specific deviations with the manufacturer.

Types of Tape Packaging of Capacitors for Automatic Radial Insertion

■ ROLL Packaging

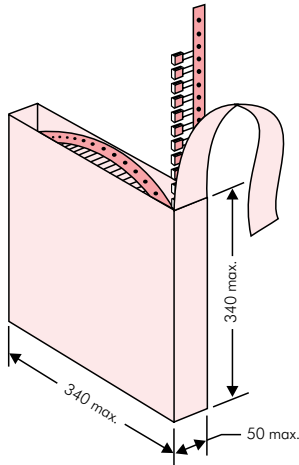

■ AMMO Packaging

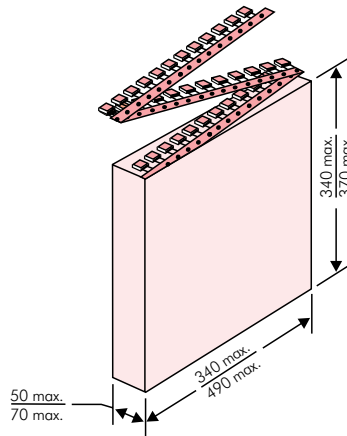

■ REEL Packaging

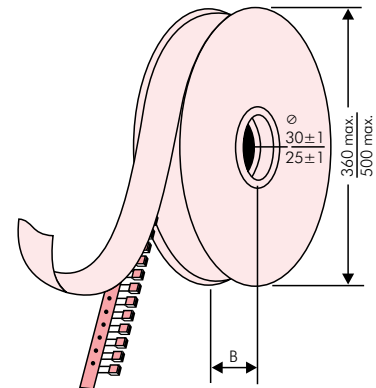

BAR CODE (Labelling)

Labelling of package units in plain text and with alphanumerical Bar Code

Scanner decoding of

- WIMA supplier number
- Customer's P/O number
- Customer's part number
- WIMA confirmation number
- WIMA part number
- Lot number
- Date code
- Quantity

In addition part description of

- article
- capacitance value
- rated voltage
- dimensions
- capacitance tolerance
- packing

as well as gross weight and customer's name are indicated in plain text.

WIMA Best Capacitors Made in Germany		Werk Unna	
Supplier-ID: 123456789	RoHS 2011/65/EU	Date Code: 08.10.10	
Purchase Order No. (P/O): Bestellung xyz		Quantity: 5.000	
Customer Part No.: KUNDETEILENUMMER		Customer No.: 0000100002	
		Gross Weight [g]: 1870	
WIMA Confirmation No.: 0001004053000100		WIMA Part No.: MKS2C034701C00K88D	
Handling Unit:	MKS 2	QTY: 5.000	COO: DE
	MKS 2 0.47 µF 63 VDC 3.5x8.5x7.2 RMS		
1000067326	Standard 10% Loss - Standard	Drühte 6-2	Week 03/2011
	Vorlage Debitor Inland		

BARCODE „Code 39“



Packing Quantities for Capacitors with Radial Pins in PCM 2.5 mm to 22.5 mm

PCM	Size				bulk	pcs. per packing unit								
						ROLL		REEL				AMMO		
	W	H	L	Codes		S	H16.5	H18.5	ø 360	ø 500	340 × 340	490 × 370		
					N	O	F	I	H	J	A	C	B	D
2.5 mm	2.5	7	4.6	0B	5000		2200	2500				2800		
	3	7.5	4.6	0C	5000		2000	2300				2300		
	3.8	8.5	4.6	0D	5000		1500	1800				1800		
	4.6	9	4.6	0E	5000		1200	1500				1500		
	5.5	10	4.6	0F	5000		900	1200				1200		
5 mm	2.5	6.5	7.2	1A	5000		2200	2500				2800		
	3	7.5	7.2	1B	5000		2000	2300				2300		
	3.5	8.5	7.2	1C	5000		1600	2000				2000		
	4.5	6	7.2	1D	6000		1300	1500				1500		
	4.5	9.5	7.2	1E	4000		1300	1500				1500		
	5	10	7.2	1F	3500		1100	1400				1400		
	5.5	7	7.2	1G	4000		1000	1200				1200		
	5.5	11.5	7.2	1H	2500		1000	1200				1200		
	6.5	8	7.2	1I	2500		800	1000				1000		
	7.2	8.5	7.2	1J	2500		700	1000				1000		
	7.2	13	7.2	1K	2000		700	950				1000		
	8.5	10	7.2	1L	2000		600	800				800		
	8.5	14	7.2	1M	1500		600	800				800		
11	16	7.2	1N	1000		500	600				400			
7.5 mm	2.5	7	10	2A	5000			2500	4400		2500			
	3	8.5	10	2B	5000			2200	4300		2300		4150	
	4	9	10	2C	4000			1700	3200		1700		3100	
	4.5	9.5	10.3	2D	3500			1500	2900		1400		2800	
	5	10.5	10.3	2E	3000			1300	2500		1300			
	5.7	12.5	10.3	2F	2000			1000	2200		1100			
	7.2	12.5	10.3	2G	1500			900	1800		1000			
10 mm	3	9	13	3A	3000			1100	2200				1900	
	4	8.5	13.5	FA	3000			900	1600				1450	
	4	9	13	3C	3000			900	1600				1450	
	4	9.5	13	3D	3000			900	1600				1400	
	5	10	13.5	FB	2000			700	1300				1200	
	5	11	13	3F	3000			700	1300				1200	
	6	12	13	3G	2400			550	1100				1000	
	6	12.5	13	3H	2400			550	1100				1000	
8	12	13	3I	2000			400	800				740		
15 mm	5	11	18	4B	2400			600	1200				1150	
	5	13	19	FC	1000			600	1200				1200	
	6	12.5	18	4C	2000			500	1000				1000	
	6	14	19	FD	1000			500	1000				1000	
	7	14	18	4D	1600			450	900				850	
	7	15	19	FE	1000			450	900				850	
	8	15	18	4F	1200			400	800				740	
	8	17	19	FF	500			400	800				740	
	9	14	18	4H	1200			350	700				650	
	9	16	18	4J	900			350	700				650	
	10	18	19	FG	500			300	650				590	
11	14	18	4M	1000			300	600				540		
22.5 mm	5	14	26.5	5A	1200				800				770	
	6	15	26.5	5B	1000				700				640	
	7	16.5	26.5	5D	760				600				550	
	8	20	28	FH	500				500				480	
	8.5	18.5	26.5	5F	500				480				450	
	10	22	28	FI	540*				420				380	
	10.5	19	26.5	5G	680*				400				360	
	10.5	20.5	26.5	5H	680*				400				360	
	11	21	26.5	5I	680*				380				350	
	12	24	28	FJ	450*				350				310	

* TPS (Tray-Packing-System). Plate versions may have different packing units. Samples and pre-production needs on request.

■ Moulded versions.

Rights reserved to amend design data without prior notification.



Packing Quantities for Capacitors with Radial Pins in PCM 27.5 mm to 52.5 mm

PCM	Size				bulk	pcs. per packing unit											
						ROLL		REEL				AMMO					
	W	H	L	Codes		S	N	O	ø 360		ø 500		340 × 340		490 × 370		
								H16.5	H18.5	H16.5	H18.5	H16.5	H18.5	H16.5	H18.5	H16.5	H18.5
								F	I	H	J	A	C	B	D		
27.5 mm	9	19	31.5	6A	640*						460/340*				420		
	11	21	31.5	6B	544*						380/280*				350		
	13	24	31.5	6D	448*						300				290		
	13	25	33	6K	336*												
	15	26	31.5	6F	384*						270				250		
	15	26	33	6L	288*												
	17	29	31.5	6G	176*												
	17	34.5	31.5	6I	176*												
	20	32	33	6M	216*												
	20	39.5	31.5	6J	144*												
37.5 mm	9	19	41.5	7A	480*												
	11	22	41.5	7B	408*												
	13	24	41.5	7C	252*												
	15	26	41.5	7D	144*												
	17	29	41.5	7E	132*												
	19	32	41.5	7F	108*												
	20	39.5	41.5	7G	108*												
	24	45.5	41.5	7H	84*												
	27	15	41.5	7M	100*												
	31	46	41.5	7I	72*												
	35	50	41.5	7J	35*												
	40	55	41.5	7K	28*												
48.5 mm	19	31	56	8D	50*												
	23	34	56	8E	72*												
	27	37.5	56	8H	60*												
	33	48	56	8J	48*												
	37	54	56	8L	25*												
52.5 mm	35	50	57	9F	25*												
	45	55	57	9H	20*												
	45	65	57	9J	20*												

* for 2-inch transport pitches.

* TPS (Tray-Packing-System). Plate versions may have different packing units. Samples and pre-production needs on request.

■ Moulded versions.

Rights reserved to amend design data without prior notification.



WIMA Part Number System

A WIMA part number consists of 18 digits and is composed as follows:

- Field 1 - 4: Type description
- Field 5 - 6: Rated voltage
- Field 7 - 10: Capacitance
- Field 11 - 12: Size and PCM
- Field 13 - 14: Version code (e.g. Snubber versions)
- Field 15: Capacitance tolerance
- Field 16: Packing
- Field 17 - 18: Pin length (untaped)

1	2	3	4	5	6	7	8	9	10	11	12	13	14	15	16	17	18
M	K	S	2	C	0	2	1	0	0	1	A	0	0	M	S	S	D
MKS 2				63 VDC		0.01 µF			2.5x6.5x7.2		-		20%	bulk	6-2		

<p>Type description:</p> <p>SMD-PET = SMDT SMD-PEN = SMDN SMD-PPS = SMDI FKP 02 = FKPO MKS 02 = MKSO FKS 2 = FKS2 FKP 2 = FKP2 MKS 2 = MKS2 MKP 2 = MKP2 FKS 3 = FKS3 FKP 3 = FKP3 MKS 4 = MKS4 MKP 4 = MKP4 MKP 10 = MKP1 FKP 4 = FKP4 FKP 1 = FKP1 MKP-X2 = MKX2 MKP-X2 R = MKXR MKP-X1 R = MKX1 MKP-Y2 = MKY2 MP 3-X2 = MPX2 MP 3-X1 = MPX1 MP 3-Y2 = MPY2 MP 3R-Y2 = MPRY Snubber MKP = SNMP Snubber FKP = SNFP GTO MKP = GTOM DC-LINK MKP 3 = DCP3 DC-LINK MKP 4 = DCP4 DC-LINK MKP 4S = DCP5 DC-LINK MKP 5 = DCP5 DC-LINK MKP 6 = DCP6 DC-LINK HC = DCHC</p>	<p>Rated voltage:</p> <p>50 VDC = B0 63 VDC = C0 100 VDC = D0 250 VDC = F0 400 VDC = G0 450 VDC = H0 600 VDC = I0 630 VDC = J0 700 VDC = K0 800 VDC = L0 850 VDC = M0 900 VDC = N0 1000 VDC = O1 1100 VDC = P0 1200 VDC = Q0 1250 VDC = R0 1500 VDC = S0 1600 VDC = T0 2000 VDC = U0 2500 VDC = V0 3000 VDC = W0 4000 VDC = X0 6000 VDC = Y0 250 VAC = 0W 275 VAC = 1W 300 VAC = 2W 305 VAC = AW 400 VAC = 3W 440 VAC = 4W 500 VAC = 5W ...</p>	<p>Capacitance:</p> <p>22 pF = 0022 47 pF = 0047 100 pF = 0100 150 pF = 0150 220 pF = 0220 330 pF = 0330 470 pF = 0470 680 pF = 0680 1000 pF = 1100 1500 pF = 1150 2200 pF = 1220 3300 pF = 1330 4700 pF = 1470 6800 pF = 1680 0.01 µF = 2100 0.022 µF = 2220 0.047 µF = 2470 0.1 µF = 3100 0.22 µF = 3220 0.47 µF = 3470 1 µF = 4100 2.2 µF = 4220 4.7 µF = 4470 10 µF = 5100 22 µF = 5220 47 µF = 5470 100 µF = 6100 220 µF = 6220 1000 µF = 7100 1500 µF = 7150 ...</p>	<p>Size:</p> <p>4.8x3.3x3 Size 1812 = KA 4.8x3.3x4 Size 1812 = KB 5.7x5.1x3.5 Size 2220 = QA 5.7x5.1x4.5 Size 2220 = QB 7.2x6.1x3 Size 2824 = TA 7.2x6.1x5 Size 2824 = TB 10.2x7.6x5 Size 4030 = VA 12.7x10.2x6 Size 5040 = XA 15.3x13.7x7 Size 6054 = YA 2.5x7x4.6 PCM 2.5 = 0B 3x7.5x4.6 PCM 2.5 = 0C 2.5x6.5x7.2 PCM 5 = 1A 3x7.5x7.2 PCM 5 = 1B 2.5x7x10 PCM 7.5 = 2A 3x8.5x10 PCM 7.5 = 2B 3x9x13 PCM 10 = 3A 4x9x13 PCM 10 = 3C 5x11x18 PCM 15 = 4B 6x12.5x18 PCM 15 = 4C 5x14x26.5 PCM 22.5 = 5A 6x15x26.5 PCM 22.5 = 5B 9x19x31.5 PCM 27.5 = 6A 11x21x31.5 PCM 27.5 = 6B 9x19x41.5 PCM 37.5 = 7A 11x22x41.5 PCM 37.5 = 7B 19x31x56 PCM 48.5 = 8D 35x50x57 PCM 52.5 = 9F ...</p>	<p>Tolerance:</p> <p>±20% = M ±10% = K ±5% = J ±2.5% = H ±1% = E ...</p> <p>Packing:</p> <p>AMMO H16.5 340x340 = A AMMO H16.5 490x370 = B AMMO H18.5 340x340 = C AMMO H18.5 490x370 = D REEL H16.5 360 = F REEL H16.5 500 = H REEL H18.5 360 = I REEL H18.5 500 = J ROLL H16.5 = N ROLL H18.5 = O BLISTER W12 180 = P BLISTER W12 330 = Q BLISTER W16 330 = R BLISTER W24 330 = T Bulk/TPS Standard = S ...</p>													

<p>Version code:</p> <p>Standard = 00 Version A1 = 1A Version A1.1.1 = 1B Version A2 = 2A ...</p>	<p>Pin length (untaped)</p> <p>3.5 ±0.5 = C9 6-2 = SD 16 ±1 = P1 ...</p>
--	---

The data on this page is not complete and serves only to explain the part number system. Part number information is listed on the pages of the respective WIMA range.

Компания «Океан Электроники» предлагает заключение долгосрочных отношений при поставках импортных электронных компонентов на взаимовыгодных условиях!

Наши преимущества:

- Поставка оригинальных импортных электронных компонентов напрямую с производств Америки, Европы и Азии, а так же с крупнейших складов мира;
- Широкая линейка поставок активных и пассивных импортных электронных компонентов (более 30 млн. наименований);
- Поставка сложных, дефицитных, либо снятых с производства позиций;
- Оперативные сроки поставки под заказ (от 5 рабочих дней);
- Экспресс доставка в любую точку России;
- Помощь Конструкторского Отдела и консультации квалифицированных инженеров;
- Техническая поддержка проекта, помощь в подборе аналогов, поставка прототипов;
- Поставка электронных компонентов под контролем ВП;
- Система менеджмента качества сертифицирована по Международному стандарту ISO 9001;
- При необходимости вся продукция военного и аэрокосмического назначения проходит испытания и сертификацию в лаборатории (по согласованию с заказчиком);
- Поставка специализированных компонентов военного и аэрокосмического уровня качества (Xilinx, Altera, Analog Devices, Intersil, Interpoint, Microsemi, Actel, Aeroflex, Peregrine, VPT, Syfer, Eurofarad, Texas Instruments, MS Kennedy, Miteq, Cobham, E2V, MA-COM, Hittite, Mini-Circuits, General Dynamics и др.);

Компания «Океан Электроники» является официальным дистрибьютором и эксклюзивным представителем в России одного из крупнейших производителей разъемов военного и аэрокосмического назначения «JONHON», а так же официальным дистрибьютором и эксклюзивным представителем в России производителя высокотехнологичных и надежных решений для передачи СВЧ сигналов «FORSTAR».



JONHON

«JONHON» (основан в 1970 г.)

Разъемы специального, военного и аэрокосмического назначения:

(Применяются в военной, авиационной, аэрокосмической, морской, железнодорожной, горно- и нефтедобывающей отраслях промышленности)

«FORSTAR» (основан в 1998 г.)

ВЧ соединители, коаксиальные кабели, кабельные сборки и микроволновые компоненты:

(Применяются в телекоммуникациях гражданского и специального назначения, в средствах связи, РЛС, а так же военной, авиационной и аэрокосмической отраслях промышленности).



Телефон: 8 (812) 309-75-97 (многоканальный)

Факс: 8 (812) 320-03-32

Электронная почта: ocean@oceanchips.ru

Web: <http://oceanchips.ru/>

Адрес: 198099, г. Санкт-Петербург, ул. Калинина, д. 2, корп. 4, лит. А