

## Description

The AH8502 is a micropower linear Hall effect sensor with an 8-bit output resolution. The output voltage is ratiometric to the supply voltage and proportional to the magnetic flux density, perpendicular to the part marking surface. The output null voltage is at half the supply voltage.

The AH8502 has a typical sensitivity of 2.1mV/G and 3.55mV/G at 1.8V and 3V. The typical null voltage offset is less than 1% of  $V_{DD}$ . The device has typical input referred rms noise of 0.36G and 0.24G at 1.8V and 3.0V.

Designed for battery powered consumer equipment to office equipment, home appliances and industrial applications, the AH8502 can operate over the supply range of 1.6V to 3.6V. The device has a CNTRL pin to select the operating modes and sampling rate to minimize power consumption. The device operates in default micropower mode with a sampling rate of 24Hz typical and consumes only 13 $\mu$ A typical at 1.8V. In turbo mode with continuous 6.25kHz sample rate the current consumption is 1mA typical. In external-drive mode, the CNTRL can be used to change the sampling frequency up to 7.14kHz with current consumption of 1.16mA typical at 1.8V.

To minimize PCB space, the AH8502 is available in small low profile U-DFN2020-6.

## Features

- Linear Hall Effect Sensor with +/-430G Sense Range and Output Voltage with 8-bit Resolution
- Supply Voltage of 1.6V to 3.6V
- Sensitivity: 2.1mV/G and 3.55mV/G at 1.8V and 3V at +25°C
- Low Offset Voltage
- Micropower (Default Mode), Turbo and External-Drive Modes
- Ultra Low Average Supply Current
  - 13 $\mu$ A Typical in Micropower Mode (Default) Period at 1.8V
  - 1.01mA Typical in Turbo Mode at 1.8V
  - 1.16mA Typical in External Drive Mode with 7.14kHz Sampling Rate at 1.8V
- Chopper Stabilized Design with Superior Temperature Stability, Minimal Sensitivity Drift, Enhanced Immunity to Physical Stress
- Output Voltage Maintained at 'Sleep' Mode
- -40°C to +85°C Operating Temperature
- High ESD Capability of 6kV Human Body Model
- Small Low Profile U-DFN2020-6 Package
- **Totally Lead-Free & Fully RoHS Compliant (Notes 1 & 2)**
- **Halogen and Antimony Free. "Green" Device (Note 3)**

Notes:

1. No purposely added lead. Fully EU Directive 2002/95/EC (RoHS) & 2011/65/EU (RoHS 2) compliant.
2. See [http://www.diodes.com/quality/lead\\_free.html](http://www.diodes.com/quality/lead_free.html) for more information about Diodes Incorporated's definitions of Halogen- and Antimony-free, "Green" and Lead-free.
3. Halogen- and Antimony-free "Green" products are defined as those which contain <900ppm bromine, <900ppm chlorine (<1500ppm total Br + Cl) and <1000ppm antimony compounds.

## Pin Assignments

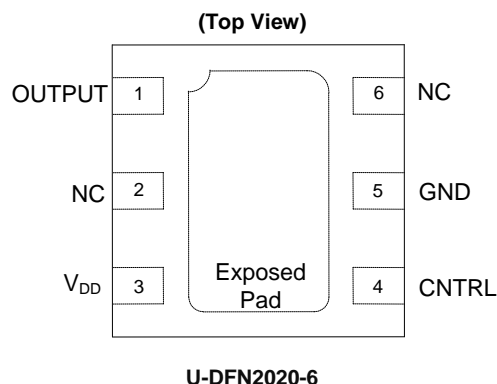

## Applications

- High Accuracy Level, Proximity, Position and Travel Detection
- Button Press Detection in Digital Still, Video Cameras and Handheld Gaming Consoles
- Accurate Door, Lids and Tray Position Detection
- Liquid Level Detection
- Joy Stick Control – Gaming and Industrial Applications
- Smart Meters
- Contact-Less Level, Proximity and Position Measurement in Home Appliances and Industrial Applications

## Typical Applications Circuit

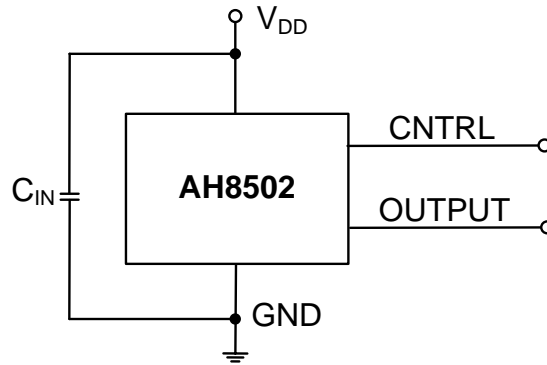

Note: 4.  $C_{IN}$  is for power stabilization and to strengthen the noise immunity, the recommended capacitance is 100nF typical and should be placed as close to the supply pin as possible.

## Pin Descriptions

| Pin Number | Pin Name | Function  |
|------------|----------|---|
| 1          | OUTPUT   | Output Pin  |
| 2          | NC       | No Connection (Note 5)  |
| 3          | $V_{DD}$ | Power Supply Input  |
| 4          | CNTRL    | <p>Device Control Pin:<br/>The CNTRL pin allows to select the modes of operation (Micropower Mode, Turbo Mode and External-Drive Mode) and to adjust the sampling rate in External Drive Mode to minimize the power consumption.</p> <p>When CNTRL = GND or floating, the device operates in default Micropower Mode with 24Hz sampling rate and consumes 13<math>\mu</math>A typical at 1.8V. The CNTRL pin is internally pulled low.</p> <p>When CNTRL = <math>V_{DD}</math>, the device is on and operates in Turbo Mode with continuous sampling rate of 6.25kHz typical consuming 1.01mA typical at 1.8V.</p> <p>In External Drive Mode, an external PWM signal can be used to drive the CNTRL pin to adjust the sampling frequency from 24Hz typical up to 7.14kHz typical. If external PWM pulse is used, the minimum pulse width needed on the CNTRL pin to start a sample/conversion is 20<math>\mu</math>s typical. We recommend using a pulse width of 40<math>\mu</math>s minimum. The minimum sample and conversion cycle is 140<math>\mu</math>s typical.</p> |
| 5          | GND      | Ground Pin  |
| 6          | NC       | No Connection (Note 5)  |
| Pad        | Pad      | <p>The center exposed pad – No connection internally.<br/>The exposed pad can be left open (unconnected) or tied to the GND on the PCB layout.</p>  |

Note: 5. NC is "No Connection" pin and is not connected internally. This pin can be left open or tied to ground.

**Functional Block Diagram**

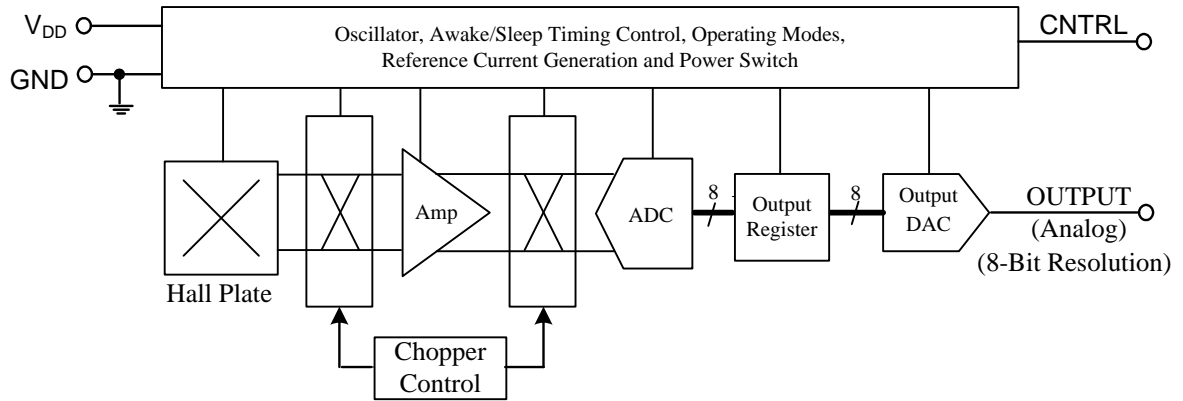

NEW PRODUCT

**Absolute Maximum Ratings** (Note 6) (@T<sub>A</sub> = +25°C, unless otherwise specified.)

| Symbol                                       | Parameter  | Rating              | Unit   |
|--|--|---------------------|--------|
| V <sub>DD</sub> and V <sub>OUT</sub>         | Supply Voltage and Output Voltage (Note 7)       | 4                   | V      |
| V <sub>DD_REV</sub> and V <sub>OUT_REV</sub> | Reverse Supply and Output Voltage                | -0.3                | V      |
| I <sub>OUT</sub>                             | Output Current (Limited by 10kΩ Output Resistor) | V <sub>DD</sub> /10 | mA     |
| B  | Magnetic Flux Density Withstand                  | Unlimited           |        |
| P <sub>D</sub>                               | Package Power Dissipation                        | U-DFN2020-6         | 230 mW |
| T <sub>s</sub>                               | Storage Temperature Range                        | -65 to +150         | °C     |
| T <sub>J</sub>                               | Maximum Junction Temperature                     | +150                | °C     |
| ESD HBM                                      | Human Body Model (HBM) ESD Capability            | 6                   | kV     |

- Notes:
- Stresses greater than the 'Absolute Maximum Ratings' specified above may cause permanent damage to the device. These are stress ratings only; functional operation of the device at these or any other conditions exceeding those indicated in this specification is not implied. Device reliability may be affected by exposure to absolute maximum rating conditions for extended periods of time.
  - The absolute maximum V<sub>DD</sub> of 4V is a transient stress rating and is not meant as a functional operating condition. It is not recommended to operate the device at the absolute maximum rated conditions for any period of time.

**Recommended Operating Conditions** (@T<sub>A</sub> = +25°C, unless otherwise specified.)

| Symbol          | Parameter                   | Conditions | Rating     | Unit |
|-----------------|-----------------------------|------------|------------|------|
| V <sub>DD</sub> | Supply Voltage              | Operating  | 1.6 to 3.6 | V    |
| T <sub>A</sub>  | Operating Temperature Range | Operating  | -40 to +85 | °C   |

**Electrical Characteristics** (Notes 8 & 9) (@T<sub>A</sub> = +25°C, V<sub>DD</sub> = 1.8V, unless otherwise specified.)

| Symbol                      | Parameter   | Conditions  | Min | Typ  | Max | Unit |
|-----------------------------|---|---|-----|------|-----|------|
| <b>Supply Current</b>       |   |   |     |      |     |      |
| I <sub>DD_UP_MODE</sub>     | Average Supply Current in Micropower Mode with Continuous Sampling Rate of 24Hz (CNTRL = GND Continuously)          | V <sub>OUTPUT</sub> = V <sub>DD</sub> /2, CNTRL = GND, V <sub>DD</sub> = 1.8V (Note 10)               | -   | 13   | 20  | μA   |
|                             |   | V <sub>OUTPUT</sub> = V <sub>DD</sub> /2, CNTRL = GND, V <sub>DD</sub> = 3.0V (Note 10)               | -   | 17   | 25  | μA   |
| I <sub>DD_TURBO_MODE</sub>  | Average Supply Current in Turbo Mode with Continuous Sampling Rate of 6.25Hz (CNTRL = V <sub>DD</sub> Continuously) | V <sub>OUTPUT</sub> = V <sub>DD</sub> /2, CNTRL = V <sub>DD</sub> , V <sub>DD</sub> = 1.8V (Note 10)  | -   | 1.01 | 1.3 | mA   |
|                             |   | V <sub>OUTPUT</sub> = V <sub>DD</sub> /2, CNTRL = GND, V <sub>DD</sub> = 3.0V (Note 10)               | -   | 1.44 | 1.8 | mA   |
| I <sub>DD_7kHz_EXTDRV</sub> | Average Supply Current at 7.14kHz Sampling Rate When CNTRL is Externally Driven                                     | V <sub>OUTPUT</sub> = V <sub>DD</sub> /2, CNTRL clocking at 7.14kHz, V <sub>DD</sub> = 1.8V (Note 10) | -   | 1.16 | 1.5 | mA   |
|                             |   | V <sub>OUTPUT</sub> = V <sub>DD</sub> /2, CNTRL clocking at 7.14kHz, V <sub>DD</sub> = 3V (Note 10)   | -   | 1.65 | 2.1 | mA   |

- Notes:
- When power is initially turned on, the operating V<sub>DD</sub> (1.6V to 3.6V) must be applied to guarantee the output sampling. After the supply voltage reaches minimum operating voltage, the output state is valid after t<sub>ON\_INITIAL</sub>.
  - Typical data is at T<sub>A</sub> = +25°C, V<sub>DD</sub> = 1.8V unless otherwise stated.
  - The parameters are not tested in production, they are guaranteed by design, characterization and process control.

**Electrical Characteristics** (Cont.) (@T<sub>A</sub> = +25°C, V<sub>DD</sub> = 1.8V, unless otherwise specified.)

**CNTRL pin timing, conversion rate and I<sub>DD</sub> supply current relationship**

**AH8502 CNTRL Pin Driven Externally – External Drive Mode**

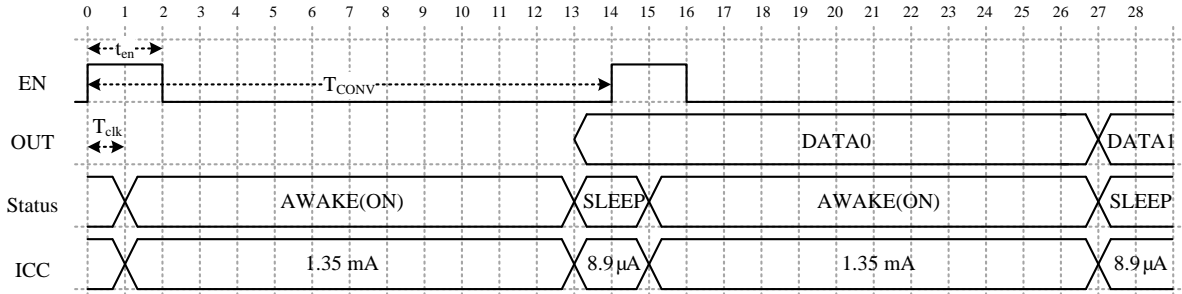

Status: **AWAKE**: chip processing phase ( $12 * T_{clk}$ ), **SLEEP**: chip retain data

$T_{clk}$ : internal clock period, typical = 10  $\mu$ s

$t_{en}$ : pulse width of enable signal, minimum =  $2 * T_{clk} = 20 \mu$ s (typical)

$T_{CONV}$ : One sample/conversion cycle =  $14 * T_{clk} = 140 \mu$ s (typical)

I<sub>DD</sub> (@ V<sub>DD</sub> = 1.8V, 25°C):

(1) If CNTRL pin clocked at maximum (~7.14 kHz):  $I_{DD} = 1.35mA * 12/14 + 8.93 \mu A * 2/14 \approx 1.16mA$

(2) If CNTRL pin clocked at 24Hz:  $I_{DD} \approx 13 \mu A$

(3) If CNTRL clocking period = T,  $I_{DD} = 1.35mA * 120 \mu s / T + 8.93 \mu A * (T - 120 \mu s) / T$

**AH8502 CNTRL = GND or Logic Low (0) Continuously – Micropower Mode**

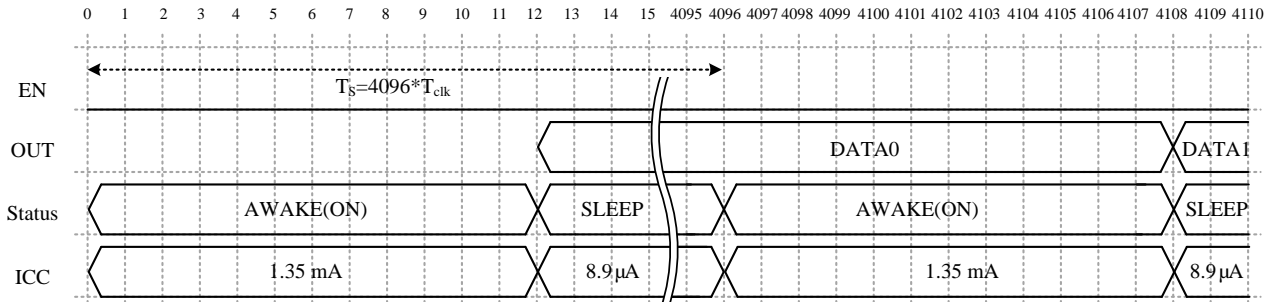

$T_{clk}$ : internal clock period, typical = 10  $\mu$ s

$T_S$ : awake cycle time =  $4096 * T_{clk} \approx 41ms$

**AH8502 CNTRL = V<sub>DD</sub> or Logic High Continuously – Turbo Mode**

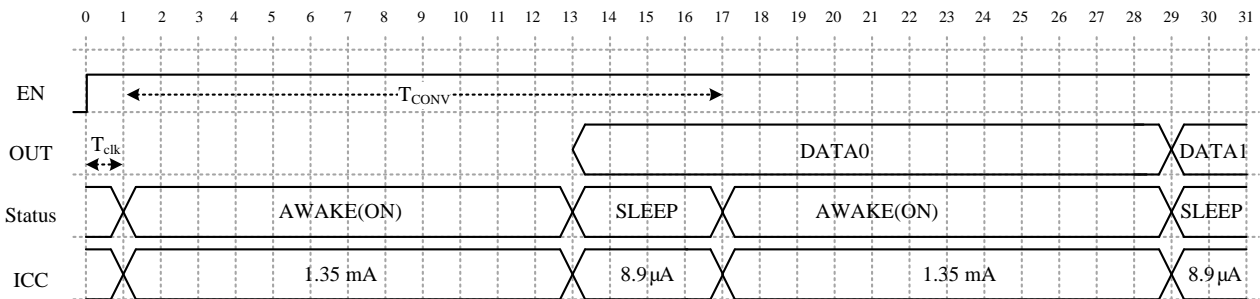

$T_{clk}$ : internal clock period, typical = 10  $\mu$ s

$T_{CONV}$ : One sample/conversion period when ENABLE = High (V<sub>DD</sub>) =  $16 * T_{clk} = 160 \mu$ s

I<sub>DD</sub> (@ V<sub>DD</sub> = 1.8V, 25°C):

$I_{DD} = 1.35mA * 120 \mu s / 160 \mu s + 8.93 \mu A * 40 \mu s / 160 \mu s \approx 1.01mA$  (typical)

**Electrical Characteristics** (Cont.) (Notes 11, 12 & 13) (@ $T_A = +25^\circ\text{C}$ ,  $V_{DD} = 1.8\text{V}$ , unless otherwise specified.)

| Symbol                        | Parameter   | Conditions  | Min | Typ                | Max | Unit          |
|-------------------------------|---|---|-----|--------------------|-----|---------------|
| $t_{ON\_INITIAL}$             | Initial Power On Time   | $V_{DD} = 1.8\text{V}$ , $T_A = +25^\circ\text{C}$ , $C_{IN}=0.1\mu\text{F}$ ,<br>$V_{DD}$ rise time =10 $\mu\text{s}$ ,<br>(Note 14) | -   | 1                  | -   | ms            |
|                               |   | $V_{DD} = 3\text{V}$ , $T_A = +25^\circ\text{C}$ , $C_{IN}=0.1\mu\text{F}$ ,<br>$V_{DD}$ rise time =10 $\mu\text{s}$ ,<br>(Note 14)   | -   | 0.2                | -   | ms            |
| $t_{en}$                      | Minimum Pulse Width on CNTRL Pin to Start One Conversion Cycle When Driving CNTRL Pin Externally (See Application Note Section) | $V_{DD} = 1.6\text{V}$ to $3.6\text{V}$ , $T_A = -40^\circ\text{C}$ to $+85^\circ\text{C}$<br>(Note 14)                               | -   | 20                 | -   | $\mu\text{s}$ |
| $T_{CONV}$                    | Minimum Period of One Sample/Conversion Cycle   | $V_{DD} = 1.6\text{V}$ to $3.6\text{V}$ , $T_A = -40^\circ\text{C}$ to $+85^\circ\text{C}$<br>(Note 14)                               | 100 | 140                | 200 | $\mu\text{s}$ |
| $f_{MAX}$                     | Maximum Sampling Frequency  | $V_{DD} = 1.6\text{V}$ to $3.6\text{V}$ , $T_A = -40^\circ\text{C}$ to $+85^\circ\text{C}$ ,<br>(Note 14)                             | -   | 7.14               | -   | kHz           |
| $f_{TURBO\_MODE}$             | Sampling Frequency in Turbo Mode with CNTRL = $V_{DD}$ or Logic High Continuously   | CNTRL = High ( $V_{DD}$ ),<br>$V_{DD} = 1.6\text{V}$ to $3.6\text{V}$ , $T_A = -40^\circ\text{C}$ to $+85^\circ\text{C}$<br>(Note 14) | -   | 6.25               | -   | kHz           |
| $f_{UP\_MODE}$                | Sampling Frequency in Micropower Mode with CNTRL = GND or Logic Low Continuously  | CNTRL = High ( $V_{DD}$ ),<br>$V_{DD} = 1.6\text{V}$ to $3.6\text{V}$ , $T_A = -40^\circ\text{C}$ to $+85^\circ\text{C}$<br>(Note 14) | -   | 24                 | -   | Hz            |
| $T_{TURBO\_MODE}$             | Awake or Sampling Period in Turbo Mode with CNTRL = $V_{DD}$ or Logic High Continuously   | CNTRL = High ( $V_{DD}$ ),<br>$V_{DD} = 1.6\text{V}$ to $3.6\text{V}$ , $T_A = -40^\circ\text{C}$ to $+85^\circ\text{C}$<br>(Note 14) | -   | 0.16               | -   | ms            |
| $T_{UP\_MODE}$                | Awake or Sampling Period in Micropower Mode with CNTRL = GND or Logic Low Continuously.   | CNTRL = High ( $V_{DD}$ ),<br>$V_{DD} = 1.6\text{V}$ to $3.6\text{V}$ , $T_A = -40^\circ\text{C}$ to $+85^\circ\text{C}$<br>(Note 14) | -   | 41.6               | -   | ms            |
| $V_{CNTRL\_LOW}$              | CNTRL Pin Input Low Voltage   | $V_{DD} = 1.8\text{V}$ (Note 13)  | 0.4 | 0.5                | 0.6 | V             |
|                               |   | $V_{DD} = 3.0\text{V}$ (Note 13)  | 0.8 | 0.9                | 1   | V             |
| $V_{CNTRL\_HIGH}$             | CNTRL Pin Input High Voltage  | $V_{DD} = 1.8\text{V}$ (Note 13)  | 1.2 | 1.3                | 1.4 | V             |
|                               |   | $V_{DD} = 3\text{V}$ (Note 13)  | 2.2 | 2.3                | 2.4 | V             |
| <b>Output Characteristics</b> |   |   |     |                    |     |               |
| $R_{OUT}$                     | DC Output Resistance  | CNTRL = $V_{DD}$ or GND,<br>$V_{DD} = 1.6\text{V}$ to $3.6\text{V}$ , $T_A = -40^\circ\text{C}$ to $+85^\circ\text{C}$ ,<br>(Note 14) | -   | 10                 | 13  | k $\Omega$    |
| Noise_RMS                     | Input Referred Noise, RMS (Note 14)   | $C_{IN} = \text{Open}$ , $V_{DD} = 1.8\text{V}$ , $T_A = +25^\circ\text{C}$ ,   | -   | 0.36               | -   | G             |
|                               |   | $C_{IN} = \text{Open}$ , $V_{DD} = 3.0\text{V}$ , $T_A = +25^\circ\text{C}$ ,   | --  | 0.24               | -   | G             |
| ADCRES<br>DACRES              | Internal ADC and DAC Resolution   | (Note 14)   | -   | 8                  | -   | Bit           |
| $V_{OUT\_RES}$                | Output Voltage Resolution   | $V_{DD} = 1.6\text{V}$ to $3.6\text{V}$ , $T_A = -40^\circ\text{C}$ to $+85^\circ\text{C}$  | -   | $V_{DD}/256$       | -   | mV            |
| $V_{OUTH}$                    | Max. Output Voltage   | $V_{DD} = 1.6\text{V}$ to $3.6\text{V}$ , $T_A = -40^\circ\text{C}$ to $+85^\circ\text{C}$  | -   | $V_{DD} * 255/256$ | -   | V             |
| $V_{OUTL}$                    | Min. Output Voltage   | $V_{DD} = 1.6\text{V}$ to $3.6\text{V}$ , $T_A = -40^\circ\text{C}$ to $+85^\circ\text{C}$  | -   | 0                  | -   | V             |

- Notes:
- When power is initially turned on, the operating  $V_{DD}$  (1.6V to 3.6V) must be applied to guarantee the output sampling. The output state is valid after  $t_{ON\_INITIAL}$  from the supply voltage reaching the minimum operating voltage.
  - Typical data is at  $T_A = +25^\circ\text{C}$ ,  $V_{DD} = 1.8\text{V}$  unless otherwise stated.
  - Maximum and minimum parameters values over operating temperature range are not tested in production, they are guaranteed by design, characterization and process control.
  - The parameter is not tested in production, they are guaranteed by design, characterization and process control.

**Electrical Characteristics** (Cont.) (Note 11, 12 & 13) (@ $T_A = +25^\circ\text{C}$ ,  $V_{DD} = 1.8\text{V}$ , unless otherwise specified.)

| Symbol                          | Parameter                                | Conditions   | Min       | Typ          | Max       | Unit          |
|---------------------------------|--|--|-----------|--------------|-----------|---------------|
| <b>Magnetic Characteristics</b> |  |  |           |              |           |               |
| $B_{\text{RANGE}}$              | Measurable Magnetic Flux Density Range   | $V_{DD} = 1.8\text{V}$ , $T_A = +25^\circ\text{C}$   | $\pm 370$ | $\pm 430$    | $\pm 505$ | G             |
|                                 |  | $V_{DD} = 3\text{V}$ , $T_A = +25^\circ\text{C}$   | $\pm 367$ | $\pm 423$    | $\pm 497$ | G             |
| $G_{\text{RES}}$                | Gauss Resolution                         | $V_{DD} = 1.8\text{V}$ , $T_A = +25^\circ\text{C}$   | 2.91      | 3.35         | 3.94      | G/LSB         |
|                                 |  | $V_{DD} = 3\text{V}$ , $T_A = +25^\circ\text{C}$   | 2.87      | 3.30         | 3.88      | G/LSB         |
| $V_{\text{NULL}}$               | Quiescent Output Voltage with Zero Gauss | $B = 0.5\text{G}$ , $T_A = +25^\circ\text{C}$  | -         | $V_{DD} / 2$ | -         | V             |
|                                 |  | $V_{DD} = 1.8\text{V}$ , $T_A = +25^\circ\text{C}$   | 0.882     | 0.9          | 0.918     | V             |
|                                 |  | $V_{DD} = 3\text{V}$ , $T_A = +25^\circ\text{C}$   | 1.47      | 1.5          | 1.53      | V             |
| $V_{\text{OFFSET}}$             | Quiescent Output Voltage Offset          | $B = 0.5\text{G}$ , $V_{DD} = 1.8\text{V}$ , $T_A = +25^\circ\text{C}$   | -1%       | -            | 1%        | % of $V_{DD}$ |
|                                 |  | $B = 0.5\text{G}$ , $V_{DD} = 3\text{V}$ , $T_A = +25^\circ\text{C}$   | -1%       | -            | 1%        | % of $V_{DD}$ |
|                                 |  | $B = 0.5\text{G}$ , $V_{DD} = 1.6\text{V to } 3.6\text{V}$ ,<br>$T_A = -40^\circ\text{C to } +85^\circ\text{C}$<br>(Note 14)                               | -1.5      | -            | 1.5       | % of $V_{DD}$ |
| $V_{\text{SENS}}$               | Output Voltage Sensitivity               | $V_{DD} = 1.8\text{V}$ , $T_A = +25^\circ\text{C}$   | 1.79      | 2.1          | 2.42      | mV/G          |
|                                 |  | $V_{DD} = 3\text{V}$ , $T_A = +25^\circ\text{C}$   | 3.02      | 3.55         | 4.08      |               |
| $V_{\text{SENS\_ACC}}$          | Sensitivity Accuracy                     | $V_{DD} = 1.8\text{V}$ , $T_A = +25^\circ\text{C}$   | -15       | -            | 15        | %             |
|                                 |  | $V_{DD} = 3\text{V}$ , $T_A = +25^\circ\text{C}$   | -15       | -            | 15        | %             |
|                                 |  | $V_{DD} = \text{fixed at any one voltage between } 1.6\text{V to } 3.6\text{V}$ ,<br>$T_A = -40^\circ\text{C to } +85^\circ\text{C}$<br>(Note 14, Note 15) | -18       | -            | 18        | %             |
| $\text{TC\_ERR}_{\text{SENS}}$  | Sensitivity Error over Full Temperature  | $V_{DD} = \text{fixed}$ , $T_A = -40^\circ\text{C to } +85^\circ\text{C}$ (Note 14)  | -3        | -            | 3         | %             |
| Lin+                            | Positive Linearity (Span Linearity)      | $V_{DD} = 1.8\text{V}$ , $T_A = +25^\circ\text{C}$ (Note 14)   | -         | 99.9         | -         | %             |
|                                 |  | $V_{DD} = 3.0\text{V}$ , $T_A = +25^\circ\text{C}$ (Note 14)   | -         | 99.7         | -         | %             |
| Lin-                            | Negative Linearity (Span Linearity)      | $V_{DD} = 1.8\text{V}$ , $T_A = +25^\circ\text{C}$ (Note 14)   | -         | 100.1        | -         | %             |
|                                 |  | $V_{DD} = 3.0\text{V}$ , $T_A = +25^\circ\text{C}$ (Note 14)   | -         | 100.4        | -         | %             |

- Notes:
11. When power is initially turned on, the operating  $V_{DD}$  (1.6V to 3.6V) must be applied to guarantee the output sampling. The output state is valid after  $t_{\text{ON\_INITIAL}}$  from the supply voltage reaching the minimum operating voltage.
  12. Typical data is at  $T_A = +25^\circ\text{C}$ ,  $V_{DD} = 1.8\text{V}$  unless otherwise stated.
  13. Maximum and minimum parameters values over operating temperature range are not tested in production, they are guaranteed by design, characterization and process control.
  14. The parameter is not tested in production, they are guaranteed by design, characterization and process control.
  15. This term constitutes of output voltage sensitivity temperature coefficient error and sensitivity accuracy.

## Application Note

### CNTRL Pin - Awake and Sleep Period and Operating Mode Control

The CNTRL pin controls the device operating mode (Micropower, Turbo, External Drive modes) and “Awake” and “Sleep” periods during external drive mode.

When the CNTRL pin is pulled low or GND continuously, the device operates in micropower mode with sampling rate of 24Hz and consumes only 13µA typical at 1.8V. The CNTRL pin is internally pulled low and therefore the default mode is micropower mode if the CNTRL pin is left floating.

When CNTRL is pulled high CNTRL = V<sub>DD</sub> (or pulled high) continuously, the device runs in turbo Mode with sampling rate of 6.25kHz and consumes 1.01mA typical at 1.8V. When the CNTRL pin is pulled high continuously, the conversion time T<sub>CONV</sub> is 16 clock cycles (160µs typical) and therefore the sampling rate is 6.25kHz.

If the CNTRL pin is driven externally with a PWM signal, the sampling rate can be adjusted from 24Hz to 7.14kHz. A minimum pulse width on CNTRL pin to start a sample/conversion is 20µs typical; we recommend using pulse width of 40µs minimum.

In external drive mode with a PWM signal on the CNTRL pin, the conversion time (signal acquisition, conversion and output update) T<sub>CONV</sub> is 14 clock cycles (140µs typical). When the CNTRL goes high, the sample trigger delay is 1 clock pulse (10µs) where supply current remains at 8.93µA typical at V<sub>DD</sub> = 1.8V. After the sample trigger delay, the next 12 clock pulse (120µs typical) is ‘Awake’ period where the typical supply current is 1.35mA at 1.8V supply. The next pulse (10µs) is used to update the output stage and during this time the supply current drops back to 8.93µA typical at 1.8V supply. Therefore, the average supply current of the device depends on the sampling frequency and at the maximum sampling rate of 7.14kHz, it is 1.16mA typical at 1.8V.

The maximum sampling frequency is 7.14kHz when the CNTRL pin is externally driven with a PWM signal.

For CNTRL pin clocking period of T, the average current is given by

$$I_{DD} = \frac{1.35mA \times 120\mu s + 8.93\mu A \times (T - 120\mu s)}{T} \quad (@1.8V)$$

$$I_{DD} = \frac{I_{DD\_AWAKE} \times 120\mu s + I_{DD\_SLEEP} \times (T - 120\mu s)}{T} \quad (\text{General equation})$$

### Quiescent Output Voltage V<sub>NULL</sub> and Offset Voltage

The figure below shows the ideal transfer curve near zero magnetic field (B = 0Gauss). Zero Gauss is the transition point between V<sub>OUTPUT</sub> = V<sub>DD</sub>\*127/128 and V<sub>OUTPUT</sub> = V<sub>DD</sub>/2. When B is slightly larger than zero, the output is one-half the supply voltage typically. Quiescent output voltage (V<sub>NULL</sub>) is defined as the typical output voltage when B = 0.5Gauss (slightly higher than 0G). Any difference of V<sub>NULL</sub> from V<sub>DD</sub>/2 introduces offset (V<sub>OFFSET</sub>).

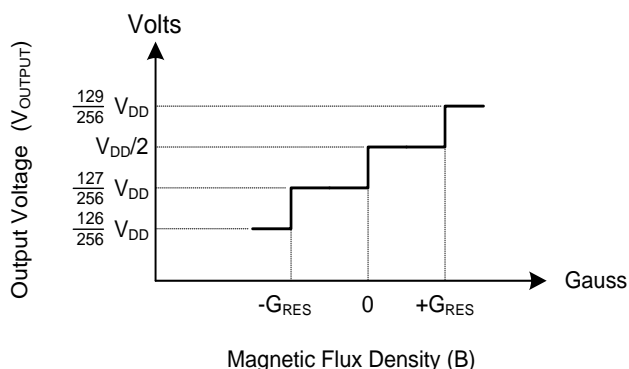

Transfer Curve Near 0 Gauss



**Application Note** (Cont.)

**Sensitivity and Transfer Characteristic**

The device responds to the magnetic flux density perpendicular to the part marking surface. For South pole magnetic flux density increase from 0G, the output voltage will increase from  $V_{NULL}$  and for a North magnetic pole field, the output will decrease from  $V_{NULL}$ . The changes in the voltage level up or down are symmetrical to  $V_{NULL}$  and are proportional to the magnetic flux density.

The output voltage change is proportional to the magnitude and polarity of the magnetic field perpendicular to the part marking surface. This proportionality is defined as output voltage sensitivity and is given by

$$V_{SENS} = \frac{(V_{OUT(B\_MAX)} - V_{OUT(B\_MIN)})}{(B_{MAX} - B_{MIN})}$$

The AH8502 has a measurable magnetic field range of +/-430G and output voltage range of 0V to (255/256) $V_{DD}$ . Therefore sensitivity at 1.8V is given by

$$V_{SENS\_1.8V} = \frac{1.8V}{860G} = 2.1mV/G$$

The device has an internal ADC and DAC with resolution of 8-bits. Therefore the measurement resolution is 3.36G/LSB at  $V_{DD} = 1.8V$ . In terms of voltage, the output resolution at 1.8V is 7mV/LSB typical. The device follows the 8-bit step for transfer curve superimposed on the  $V_{SENS}$  above. This difference in theoretical linear value with 8-bit resolution steps produces measurement (quantization) error at each step.

Quantization error (also measurement error) =  $0.5 \cdot \text{step} = V_{DD}/512(\text{output voltage})$   
Or = Full magnetic range/512 (input magnetic field)

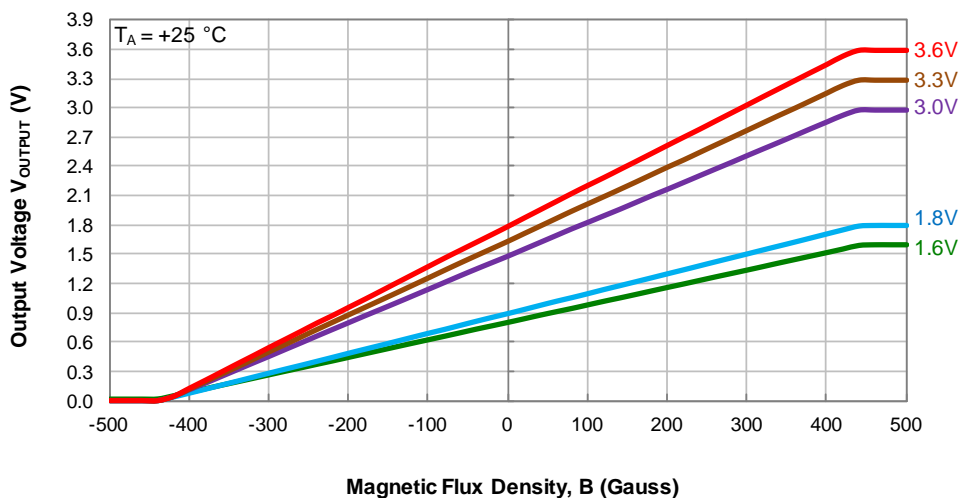

**Transfer Curve – Output Voltage vs. Magnetic Flux Density**

**Application Note** (Cont.)

**Span Linearity**

Coordinate of transition points (V0-V255 and B0-B254) can be extracted from a transfer curve. Span linearity is defined and based on these coordinate points.

Span linearity is defined as linearity arising from sensitivity differences between the maximum flux density range and half of the range for positive and negative flux density. Referring to the diagram below, north field span linearity LIN- and south field span linearity LIN+ are given by:

$$LIN- = \frac{(V0 - V127)/(B0 - B127)}{(V64 - V127)/(B64 - B127)}$$

$$LIN+ = \frac{(V254 - V127)/(B254 - B127)}{(V190 - V127)/(B190 - B127)}$$

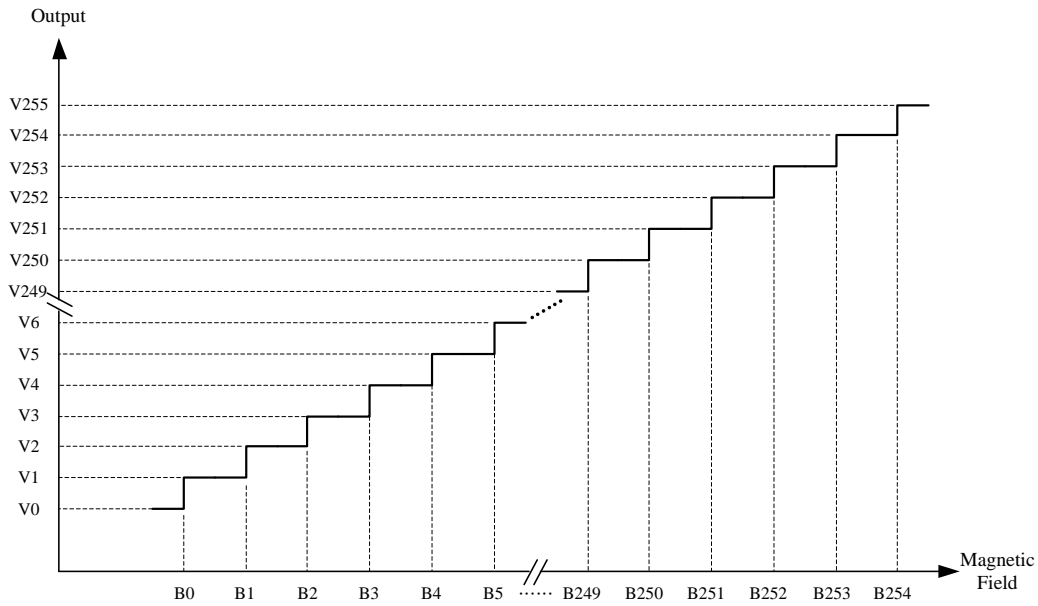

NEW PRODUCT

## Typical Operating Characteristics

### Average Supply Current

Micropower Mode (Default) – 24Hz Sample Rate

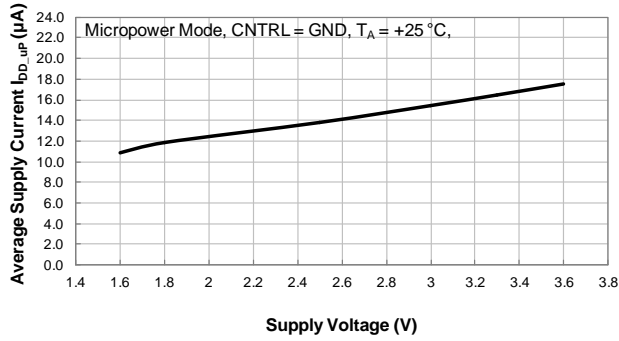

Average Supply Current (CNTRL = GND) vs Supply Voltage

Micropower Mode (Default)

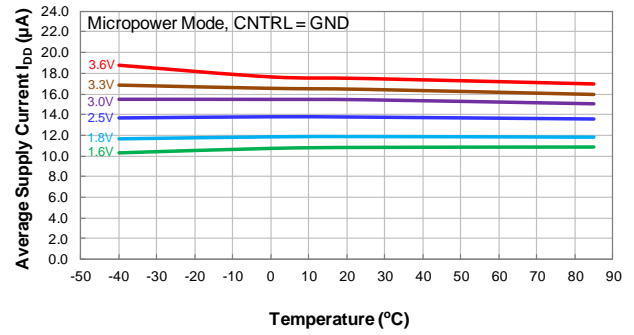

Average Supply Current (CNTRL = GND) vs Temperature

Turbo Mode – 6.25kHz Sample Rate

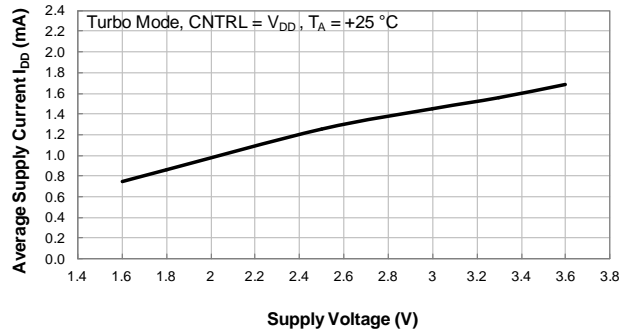

Average Supply Current (CNTRL = V<sub>DD</sub>) vs Supply Voltage

Turbo Mode – 6.25kHz Sample Rate

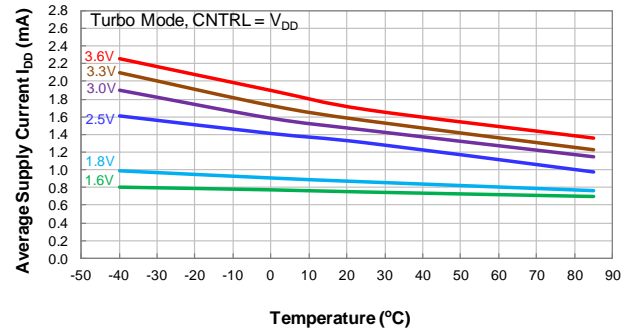

Average Supply Current (CNTRL = V<sub>DD</sub>) vs Temperature

External Drive Mode with 7.14kHz Sampling Rate

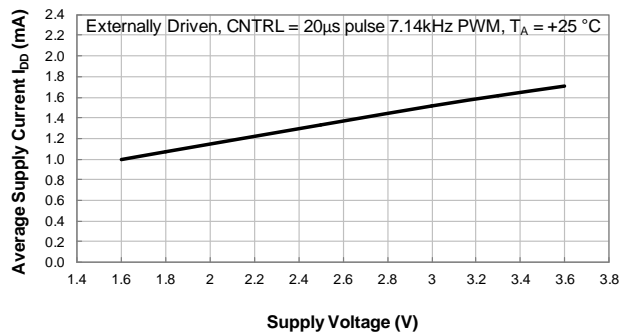

Average Supply Current (CNTRL = PWM) vs Supply Voltage

External Drive Mode with 7.14kHz Sampling Rate

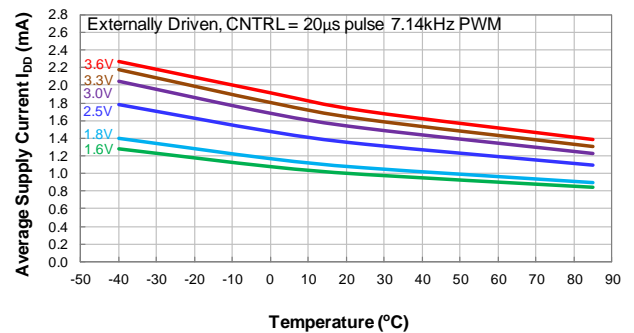

Average Supply Current (CNTRL = PWM) vs Temperature

**Typical Operating Characteristics (Cont.)**

**Typical Initial Power On Time**

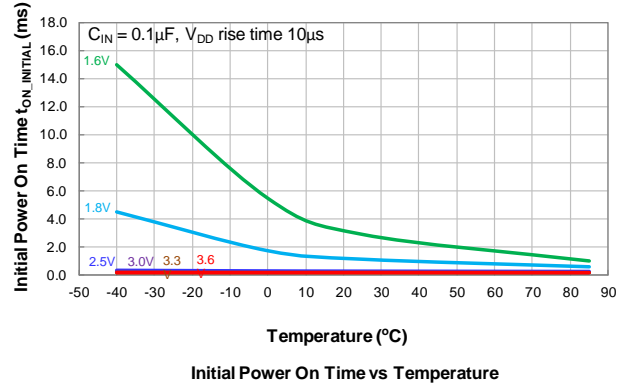
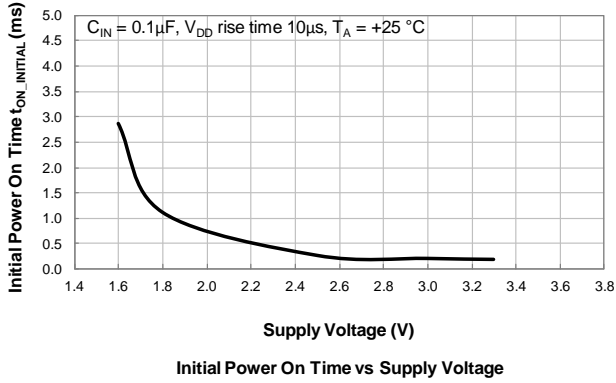

**Typical Sensitivity**

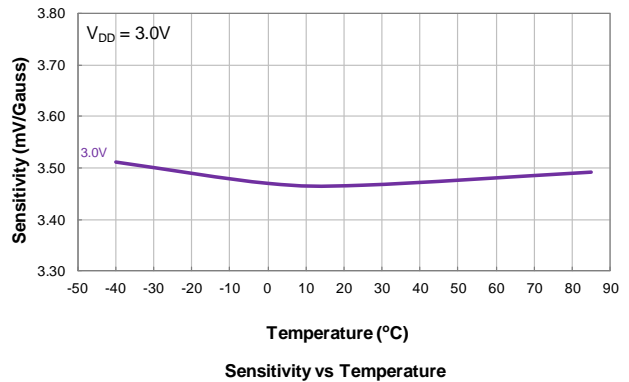
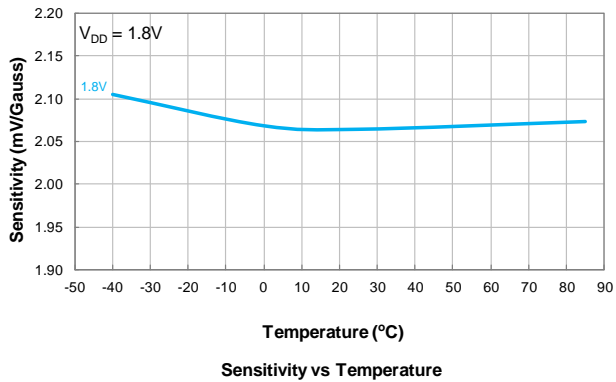
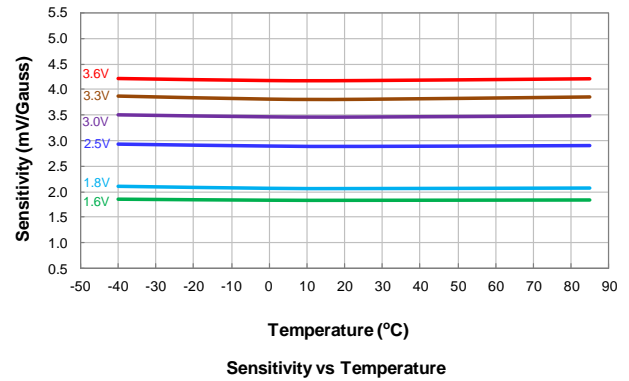
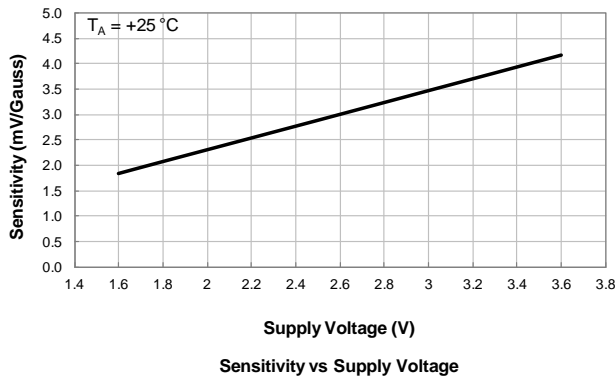

NEW PRODUCT

**Typical Operating Characteristics (Cont.)**

**Typical Transfer Curves**

NEW PRODUCT

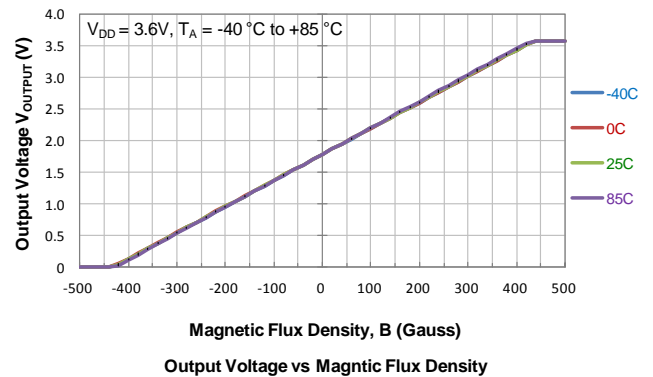
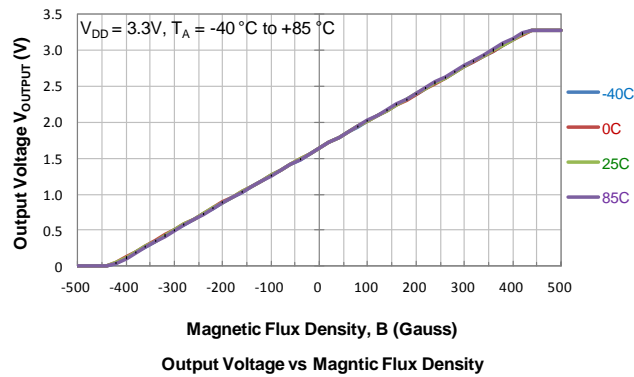
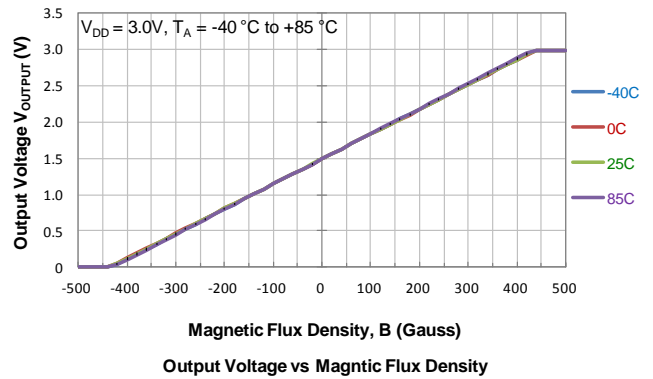
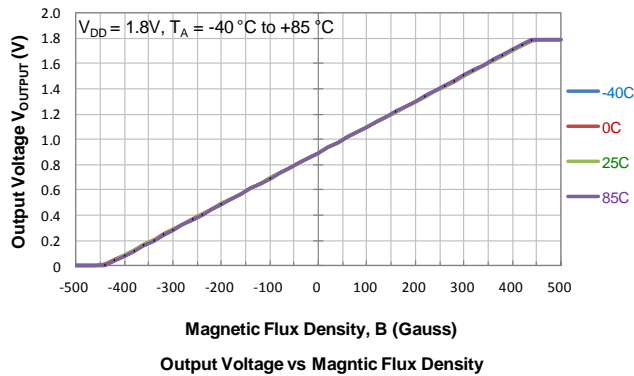
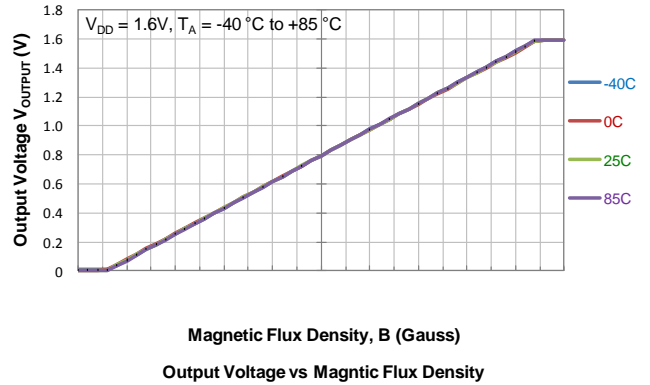
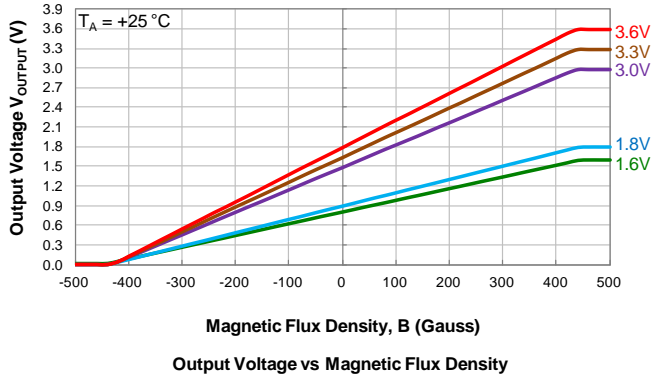

**Typical Operating Characteristics** (Cont.)

**Typical Null Voltage:** Output Voltage at B = 0+ Gauss (Note 16)

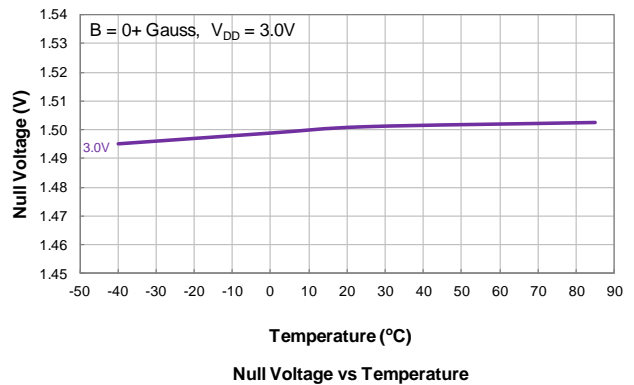
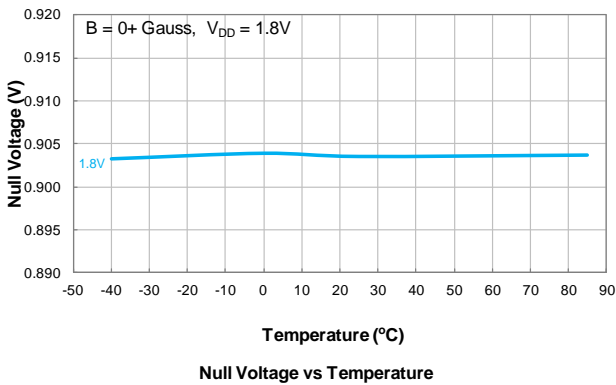
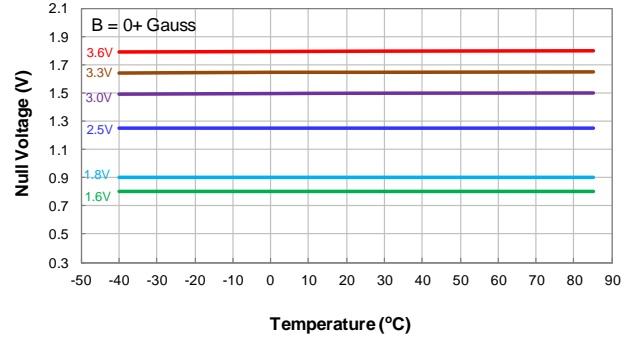
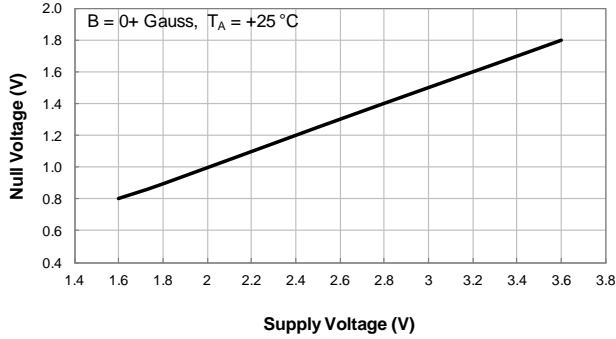

Note: 16. Null voltage is the voltage with magnetic flux density B = 0G at the sensor. B = 0G is also the transition point at  $V_{DD} * 127/128$  for internal ADC and DAC. To avoid the transition point fluctuation during measurement of null voltage, B = 0+ Gauss (e.g. 0.5G which is smaller than 1LSB gauss step of 3.125G) is used. See definition of the null voltage in Application Note section.

NEW PRODUCT

**Typical Operating Characteristics (Cont.)**

**Typical Null Voltage Offset:** (Output Voltage -  $V_{DD}/2$ ) at B = 0 Gauss (Note 16)

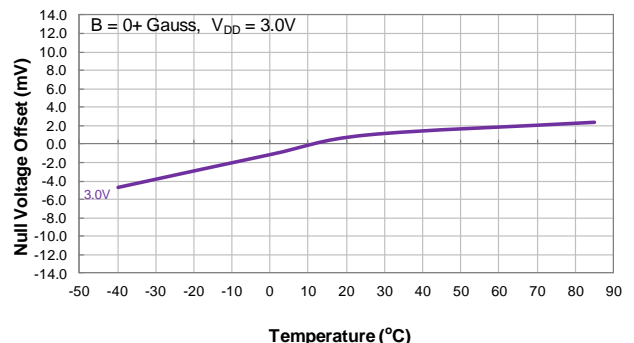
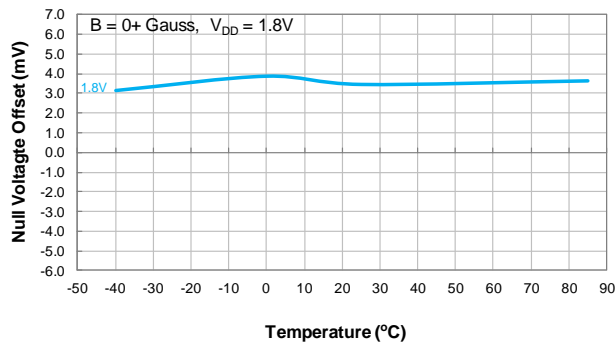
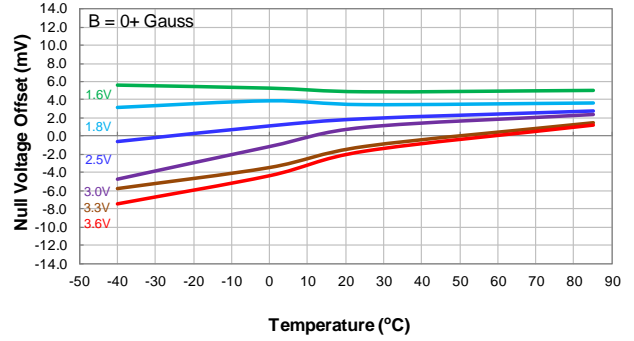
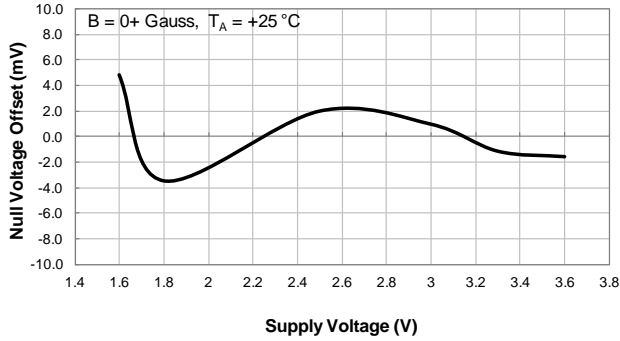

Note: 16. Null voltage is the voltage with magnetic flux density B = 0G at the sensor. B = 0G is also the transition point at  $V_{DD} \cdot 127/128$  for internal ADC and DAC. To avoid the transition point fluctuation during measurement of null voltage, B = 0+ Gauss (e.g. 0.5G which is smaller than 1LSB gauss step of 3.125G) is used. See definition of the null voltage in Application Note section.

**Ordering Information**

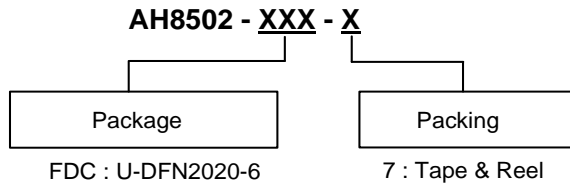

| Part Number  | Package Code | Packaging   | 7" Tape and Reel  |                    |
|--------------|--------------|-------------|-------------------|--------------------|
|              |              |             | Quantity          | Part Number Suffix |
| AH8502-FDC-7 | FDC          | U-DFN2020-6 | 3,000/Tape & Reel | -7                 |

**Marking Information**

(1) Package Type: U-DFN2020-6

( Top View )

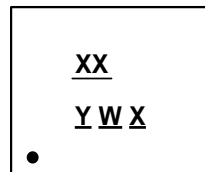

XX : Identification Code  
Y : Year : 0~9  
W : Week : A~Z : 1~26 week;  
a~z : 27~52 week; z represents  
52 and 53 week  
X : Internal Code

| Part Number  | Package     | Identification Code |
|--------------|-------------|---------------------|
| AH8502-FDC-7 | U-DFN2020-6 | KX                  |



**Package Outline Dimensions** (All dimensions in mm.)

Please see AP02002 at <http://www.diodes.com/datasheets/ap02002.pdf> for the latest version.

(1) Package Type: U-DFN2020-6 (Type C)

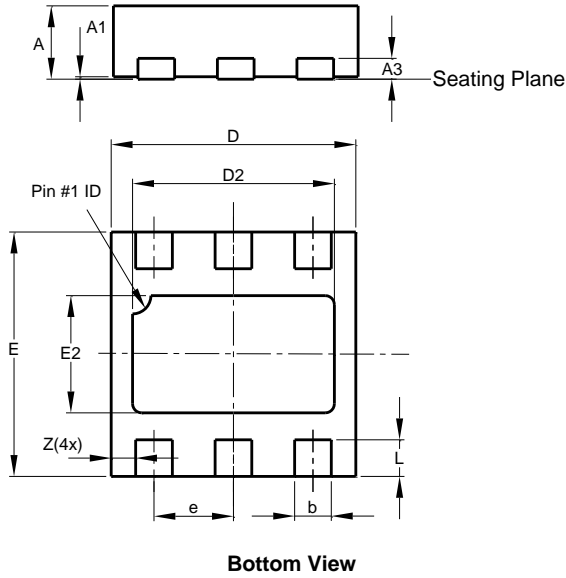

| U-DFN2020-6<br>Type C |      |       |      |
|-----------------------|------|-------|------|
| Dim                   | Min  | Max   | Typ  |
| A                     | 0.57 | 0.63  | 0.60 |
| A1                    | 0.00 | 0.05  | 0.02 |
| A3                    | -    | -     | 0.15 |
| b                     | 0.25 | 0.35  | 0.30 |
| D                     | 1.95 | 2.075 | 2.00 |
| D2                    | 1.55 | 1.75  | 1.65 |
| E                     | 1.95 | 2.075 | 2.0  |
| E2                    | 0.86 | 1.06  | 0.96 |
| e                     | -    | -     | 0.65 |
| L                     | 0.25 | 0.35  | 0.30 |
| Z                     | -    | -     | 0.20 |
| All Dimensions in mm  |      |       |      |

NEW PRODUCT

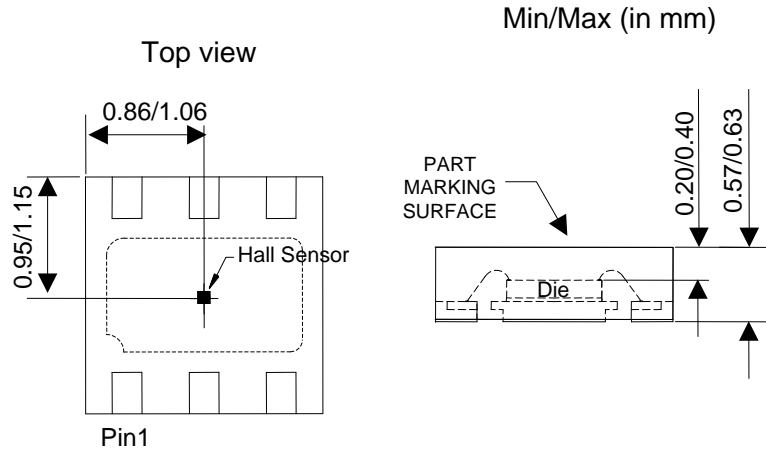

## Suggested Pad Layout

Please see AP02001 at <http://www.diodes.com/datasheets/ap02001.pdf> for the latest version.

(1) Package Type: U-DFN2020-6 (Type C)

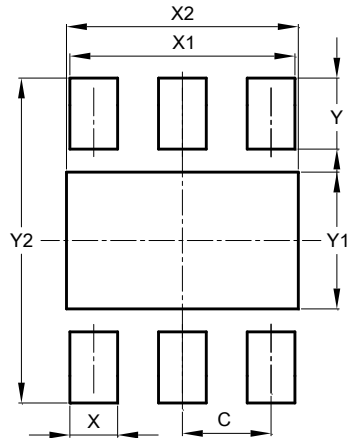

| Dimensions | Value (in mm) |
|------------|---------------|
| C          | 0.650         |
| X          | 0.350         |
| X1         | 1.650         |
| X2         | 1.700         |
| Y          | 0.525         |
| Y1         | 1.010         |
| Y2         | 2.400         |

**IMPORTANT NOTICE**

DIODES INCORPORATED MAKES NO WARRANTY OF ANY KIND, EXPRESS OR IMPLIED, WITH REGARDS TO THIS DOCUMENT, INCLUDING, BUT NOT LIMITED TO, THE IMPLIED WARRANTIES OF MERCHANTABILITY AND FITNESS FOR A PARTICULAR PURPOSE (AND THEIR EQUIVALENTS UNDER THE LAWS OF ANY JURISDICTION).

Diodes Incorporated and its subsidiaries reserve the right to make modifications, enhancements, improvements, corrections or other changes without further notice to this document and any product described herein. Diodes Incorporated does not assume any liability arising out of the application or use of this document or any product described herein; neither does Diodes Incorporated convey any license under its patent or trademark rights, nor the rights of others. Any Customer or user of this document or products described herein in such applications shall assume all risks of such use and will agree to hold Diodes Incorporated and all the companies whose products are represented on Diodes Incorporated website, harmless against all damages.

Diodes Incorporated does not warrant or accept any liability whatsoever in respect of any products purchased through unauthorized sales channel. Should Customers purchase or use Diodes Incorporated products for any unintended or unauthorized application, Customers shall indemnify and hold Diodes Incorporated and its representatives harmless against all claims, damages, expenses, and attorney fees arising out of, directly or indirectly, any claim of personal injury or death associated with such unintended or unauthorized application.

Products described herein may be covered by one or more United States, international or foreign patents pending. Product names and markings noted herein may also be covered by one or more United States, international or foreign trademarks.

This document is written in English but may be translated into multiple languages for reference. Only the English version of this document is the final and determinative format released by Diodes Incorporated.

**LIFE SUPPORT**

Diodes Incorporated products are specifically not authorized for use as critical components in life support devices or systems without the express written approval of the Chief Executive Officer of Diodes Incorporated. As used herein:

A. Life support devices or systems are devices or systems which:

1. are intended to implant into the body, or
2. support or sustain life and whose failure to perform when properly used in accordance with instructions for use provided in the labeling can be reasonably expected to result in significant injury to the user.

B. A critical component is any component in a life support device or system whose failure to perform can be reasonably expected to cause the failure of the life support device or to affect its safety or effectiveness.

Customers represent that they have all necessary expertise in the safety and regulatory ramifications of their life support devices or systems, and acknowledge and agree that they are solely responsible for all legal, regulatory and safety-related requirements concerning their products and any use of Diodes Incorporated products in such safety-critical, life support devices or systems, notwithstanding any devices- or systems-related information or support that may be provided by Diodes Incorporated. Further, Customers must fully indemnify Diodes Incorporated and its representatives against any damages arising out of the use of Diodes Incorporated products in such safety-critical, life support devices or systems.

Copyright © 2015, Diodes Incorporated

[www.diodes.com](http://www.diodes.com)

Компания «Океан Электроники» предлагает заключение долгосрочных отношений при поставках импортных электронных компонентов на взаимовыгодных условиях!

Наши преимущества:

- Поставка оригинальных импортных электронных компонентов напрямую с производств Америки, Европы и Азии, а так же с крупнейших складов мира;
- Широкая линейка поставок активных и пассивных импортных электронных компонентов (более 30 млн. наименований);
- Поставка сложных, дефицитных, либо снятых с производства позиций;
- Оперативные сроки поставки под заказ (от 5 рабочих дней);
- Экспресс доставка в любую точку России;
- Помощь Конструкторского Отдела и консультации квалифицированных инженеров;
- Техническая поддержка проекта, помощь в подборе аналогов, поставка прототипов;
- Поставка электронных компонентов под контролем ВП;
- Система менеджмента качества сертифицирована по Международному стандарту ISO 9001;
- При необходимости вся продукция военного и аэрокосмического назначения проходит испытания и сертификацию в лаборатории (по согласованию с заказчиком);
- Поставка специализированных компонентов военного и аэрокосмического уровня качества (Xilinx, Altera, Analog Devices, Intersil, Interpoint, Microsemi, Actel, Aeroflex, Peregrine, VPT, Syfer, Eurofarad, Texas Instruments, MS Kennedy, Miteq, Cobham, E2V, MA-COM, Hittite, Mini-Circuits, General Dynamics и др.);

Компания «Океан Электроники» является официальным дистрибьютором и эксклюзивным представителем в России одного из крупнейших производителей разъемов военного и аэрокосмического назначения «JONHON», а так же официальным дистрибьютором и эксклюзивным представителем в России производителя высокотехнологичных и надежных решений для передачи СВЧ сигналов «FORSTAR».



## JONHON

«JONHON» (основан в 1970 г.)

Разъемы специального, военного и аэрокосмического назначения:

(Применяются в военной, авиационной, аэрокосмической, морской, железнодорожной, горно- и нефтедобывающей отраслях промышленности)

«FORSTAR» (основан в 1998 г.)

ВЧ соединители, коаксиальные кабели, кабельные сборки и микроволновые компоненты:

(Применяются в телекоммуникациях гражданского и специального назначения, в средствах связи, РЛС, а так же военной, авиационной и аэрокосмической отраслях промышленности).



Телефон: 8 (812) 309-75-97 (многоканальный)

Факс: 8 (812) 320-03-32

Электронная почта: [ocean@oceanchips.ru](mailto:ocean@oceanchips.ru)

Web: <http://oceanchips.ru/>

Адрес: 198099, г. Санкт-Петербург, ул. Калинина, д. 2, корп. 4, лит. А