

Notice for TAIYO YUDEN products

Please read this notice before using the TAIYO YUDEN products.

⚠️ REMINDERS

■ Product Information in this Catalog

Product information in this catalog is as of October 2019. All of the contents specified herein and production status of the products listed in this catalog are subject to change without notice due to technical improvement of our products, etc. Therefore, please check for the latest information carefully before practical application or use of our products.

Please note that TAIYO YUDEN shall not be in any way responsible for any damages and defects in products or equipment incorporating our products, which are caused under the conditions other than those specified in this catalog or individual product specification sheets.

■ Approval of Product Specifications

Please contact TAIYO YUDEN for further details of product specifications as the individual product specification sheets are available. When using our products, please be sure to approve our product specifications or make a written agreement on the product specification with TAIYO YUDEN in advance.

■ Pre-Evaluation in the Actual Equipment and Conditions

Please conduct validation and verification of our products in actual conditions of mounting and operating environment before using our products.

■ Limited Application

1. Equipment Intended for Use

The products listed in this catalog are intended for general-purpose and standard use in general electronic equipment (e.g., AV equipment, OA equipment, home electric appliances, office equipment, information and communication equipment including, without limitation, mobile phone, and PC) and other equipment specified in this catalog or the individual product specification sheets.

TAIYO YUDEN has the line-up of the products intended for use in automotive electronic equipment, telecommunications infrastructure and industrial equipment, or medical devices classified as GHTF Classes A to C (Japan Classes I to III). Therefore, when using our products for these equipment, please check available applications specified in this catalog or the individual product specification sheets and use the corresponding products.

2. Equipment Requiring Inquiry

Please be sure to contact TAIYO YUDEN for further information before using the products listed in this catalog for the following equipment (excluding intended equipment as specified in this catalog or the individual product specification sheets) which may cause loss of human life, bodily injury, serious property damage and/or serious public impact due to a failure or defect of the products and/or malfunction attributed thereto.

- (1) Transportation equipment (automotive powertrain control system, train control system, and ship control system, etc.)
- (2) Traffic signal equipment
- (3) Disaster prevention equipment, crime prevention equipment
- (4) Medical devices classified as GHTF Class C (Japan Class III)
- (5) Highly public information network equipment, data-processing equipment (telephone exchange, and base station, etc.)
- (6) Any other equipment requiring high levels of quality and/or reliability equal to the equipment listed above

3. Equipment Prohibited for Use

Please do not incorporate our products into the following equipment requiring extremely high levels of safety and/or reliability.

- (1) Aerospace equipment (artificial satellite, rocket, etc.)
- (2) Aviation equipment *¹
- (3) Medical devices classified as GHTF Class D (Japan Class IV), implantable medical devices *²

- (4) Power generation control equipment (nuclear power, hydroelectric power, thermal power plant control system, etc.)
- (5) Undersea equipment (submarine repeating equipment, underwater work equipment, etc.)
- (6) Military equipment
- (7) Any other equipment requiring extremely high levels of safety and/or reliability equal to the equipment listed above

*Notes:

1. There is a possibility that our products can be used only for aviation equipment that does not directly affect the safe operation of aircraft (e.g., in-flight entertainment, cabin light, electric seat, cooking equipment) if such use meets requirements specified separately by TAIYO YUDEN. Please be sure to contact TAIYO YUDEN for further information before using our products for such aviation equipment.
2. Implantable medical devices contain not only internal unit which is implanted in a body, but also external unit which is connected to the internal unit.

4. Limitation of Liability

Please note that unless you obtain prior written consent of TAIYO YUDEN, TAIYO YUDEN shall not be in any way responsible for any damages incurred by you or third parties arising from use of the products listed in this catalog for any equipment that is not intended for use by TAIYO YUDEN, or any equipment requiring inquiry to TAIYO YUDEN or prohibited for use by TAIYO YUDEN as described above.

■ Safety Design

When using our products for high safety and/or reliability-required equipment or circuits, please fully perform safety and/or reliability evaluation. In addition, please install (i) systems equipped with a protection circuit and a protection device and/or (ii) systems equipped with a redundant circuit or other system to prevent an unsafe status in the event of a single fault for a failsafe design to ensure safety.

■ Intellectual Property Rights

Information contained in this catalog is intended to convey examples of typical performances and/or applications of our products and is not intended to make any warranty with respect to the intellectual property rights or any other related rights of TAIYO YUDEN or any third parties nor grant any license under such rights.

■ Limited Warranty

Please note that the scope of warranty for our products is limited to the delivered our products themselves and TAIYO YUDEN shall not be in any way responsible for any damages resulting from a failure or defect in our products. Notwithstanding the foregoing, if there is a written agreement (e.g., supply and purchase agreement, quality assurance agreement) signed by TAIYO YUDEN and your company, TAIYO YUDEN will warrant our products in accordance with such agreement.

■ TAIYO YUDEN's Official Sales Channel

The contents of this catalog are applicable to our products which are purchased from our sales offices or authorized distributors (hereinafter "TAIYO YUDEN's official sales channel"). Please note that the contents of this catalog are not applicable to our products purchased from any seller other than TAIYO YUDEN's official sales channel.

■ Caution for Export

Some of our products listed in this catalog may require specific procedures for export according to "U.S. Export Administration Regulations", "Foreign Exchange and Foreign Trade Control Law" of Japan, and other applicable regulations. Should you have any questions on this matter, please contact our sales staff.



REFLOW

■ PARTS NUMBER

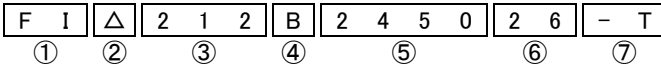

△ = Blank space

① Series name

Code	Series name
FI	High frequency devices

② Electrode code

Code	Electrode code
△	With plating

③ Dimensions

Code	Dimensions [mm]
212	2.0 × 1.25
168	1.6 × 0.8
105	1.0 × 0.5

⑤ Frequency

Code (example)	Frequency [MHz]
2450	2400 ~ 2500
0620	470 ~ 770

⑥ Spec code

Code	Spec code
01 ~	Individual spec

⑦ Packaging

Code	Packaging
-T	Taping

④ Special code

Code	Special code
B	Band pass type
L	Low pass type
H	High pass type
C	Balance type
P	Diplexer
W	2 Branch coupler
D	Dual type
K	Coupler

■ EXTERNAL DIMENSIONS / STANDARD QUANTITY

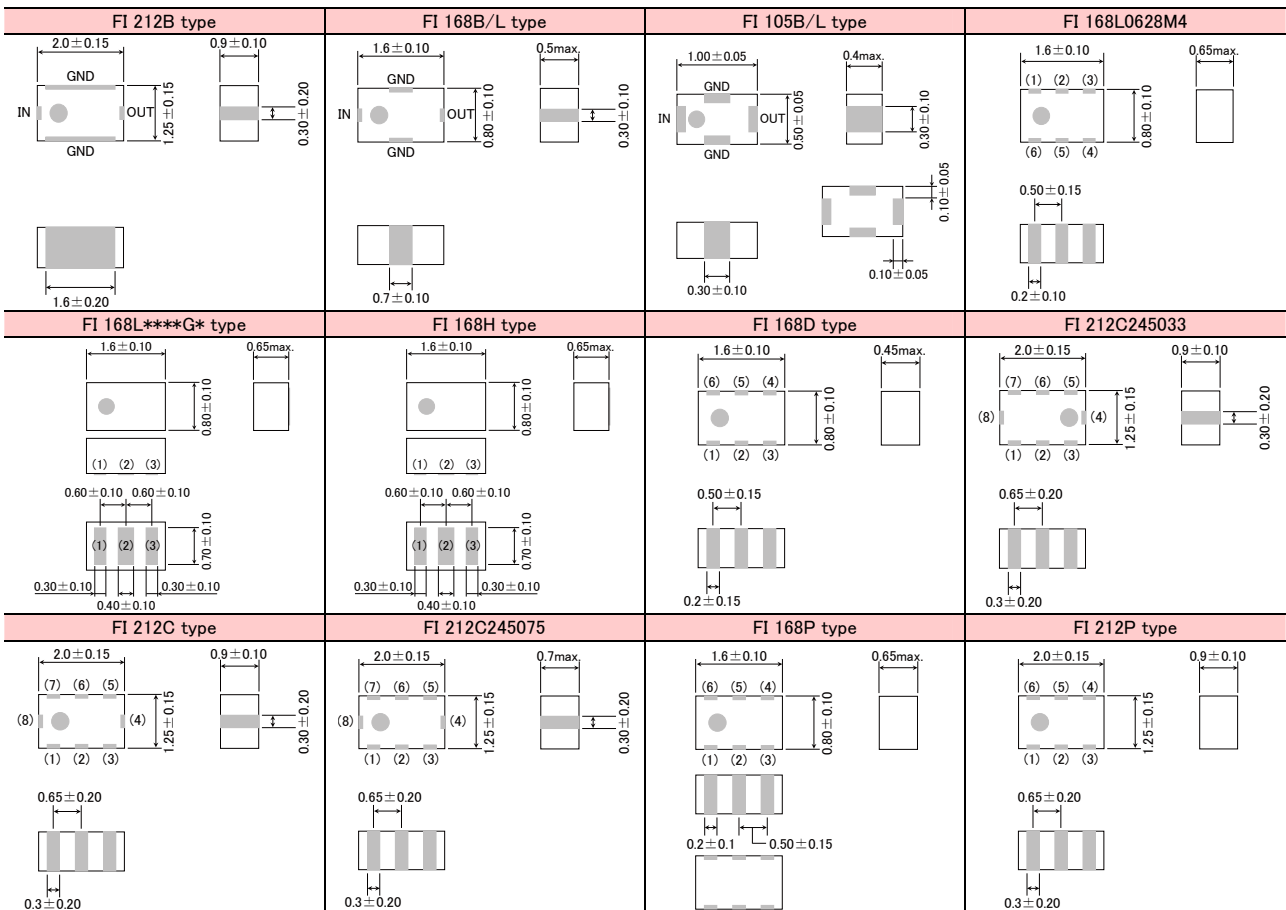

Unit : mm

► This catalog contains the typical specification only due to the limitation of space. When you consider the purchase of our products, please check our product specification sheets. For details of each product (characteristics graph, reliability information, precautions for use, and so on), see our website (<http://www.ty-top.com/>).

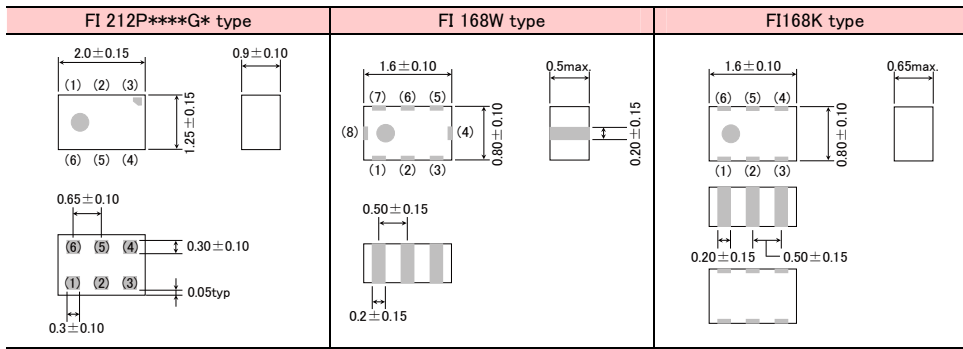

Unit: mm

	FI 168L0628M4	FI 168L***G* type	FI 168H type	FI 168D087018	FI 212C2450**	FI 168P245030
(1)	I/O Port	RF IN/OUT	RF IN/OUT	High Band IN	Balanced	GND
(2)	GND	GND	GND	GND	GND	Common
(3)	I/O Port	RF IN/OUT	RF IN/OUT	Low Band IN	Balanced	GND
(4)	GND	-	-	Low Band OUT	GND	Low Band
(5)	GND	-	-	GND	Unbalance	GND
(6)	GND	-	-	High Band OUT	DC	High Band
(7)	-	-	-	-	NC	-
(8)	-	-	-	-	GND	-

	FI 212P***G* type	FI 212P089208 FI 212P085912	FI 212P089213 FI 212P085909	FI 168P157519	FI 168W type	FI 168K type
(1)	Low Band	GND	GND	GND	RF1 IN/OUT	COUPLING
(2)	GND	Common Port	Common Port	High Band	CPL2 RF1	GND
(3)	High Band	GND	GND	Common	CPL2 RF2	ISOLATION
(4)	GND	High Band	Low Band	Low Band	GND	RF OUT
(5)	Common	GND	GND	-	RF2 OUT/IN	GND
(6)	GND	Low Band	High Band	-	CPL1 RF2	RF IN
(7)	-	-	-	-	CPL1 RF1	-
(8)	-	-	-	-	GND	-

Type	Standard quantity [pcs]
212	3000~6000
168	4000~8000
105	10000

► This catalog contains the typical specification only due to the limitation of space. When you consider the purchase of our products, please check our product specification sheets. For details of each product (characteristics graph, reliability information, precautions for use, and so on), see our website (<http://www.ty-top.com/>).

PARTS NUMBER

● Multilayer device band pass type

Applications	External dimensions [mm]	Part number
2.4GHz W-LAN / Bluetooth®	2.0 × 1.25 × 1.0max.	FI 212B245026
	2.0 × 1.25 × 1.0max.	FI 212B245027
	1.6 × 0.8 × 0.5max.	FI 168B245001
	1.0 × 0.5 × 0.4max.	FI 105B245024

● Multilayer device low pass type

Applications	External dimensions [mm]	Part number
Digital TV	1.6 × 0.8 × 0.45max.	FI 168L062005
2.4GHz W-LAN / Bluetooth®	1.0 × 0.5 × 0.4max.	FI 105L250014
	1.0 × 0.5 × 0.4max.	FI 105L186822
Cellular	1.0 × 0.5 × 0.4max.	FI 105L087038
	1.6 × 0.8 × 0.65max.	FI 168L0628M4
	1.6 × 0.8 × 0.65max.	FI 168L2200G9
	1.6 × 0.8 × 0.65max.	FI 168L1681G6

● Multilayer device high pass type

Applications	External dimensions [mm]	Part number
Cellular	1.6 × 0.8 × 0.65max.	FI 168H2593GG

Applications	External dimensions [mm]	Part number	Notes
Other	1.6 × 0.8 × 0.45max.	FI 168D087018	Dual band LPF

● Multilayer device balance type

Applications	External dimensions [mm]	Part number	Notes
Bluetooth®	2.0 × 1.25 × 1.0max.	FI 212C245033	Conjugated match to CSR BC3
	2.0 × 1.25 × 1.0max.	FI 212C245036	Conjugated match to CSR BC5
	2.0 × 1.25 × 0.7max.	FI 212C245075	Conjugated match to CSR BC5FM, BC6ROM

● Multilayer diplexer

Applications	External dimensions [mm]	Part number
W-LAN	1.6 × 0.8 × 0.65max.	FI 168P245030
Cellular	2.0 × 1.25 × 1.0max.	FI 212P082931
	2.0 × 1.25 × 1.0max.	FI 212P0829G2
	2.0 × 1.25 × 1.0max.	FI 212P082934
	2.0 × 1.25 × 1.0max.	FI 212P082935
	2.0 × 1.25 × 1.0max.	FI 212P089208
	2.0 × 1.25 × 1.0max.	FI 212P089213
	2.0 × 1.25 × 1.0max.	FI 212P085909
	2.0 × 1.25 × 1.0max.	FI 212P085912
	GPS / 2.4GHz W-LAN	1.6 × 0.8 × 0.65max.
1.6 × 0.8 × 0.65max.		FI 168P157525

● Multilayer coupler

Applications	External dimensions [mm]	Part number
Cellular	1.6 × 0.8 × 0.5max.	FI 168W1697B1
	1.6 × 0.8 × 0.5max.	FI 168K1687AA

► This catalog contains the typical specification only due to the limitation of space. When you consider the purchase of our products, please check our product specification sheets. For details of each product (characteristics graph, reliability information, precautions for use, and so on), see our website (<http://www.ty-top.com/>).

■ ELECTRICAL CHARACTERISTICS / TYPICAL CHARACTERISTICS

FI 212B245026

Pass band frequency	2400 - 2500 MHz
Insertion loss at pass band	2.6 dB max. (+25°C)
	2.9 dB max. (-40~+85°C)
Ripple at pass band	1.0 dB max.
V.S.W.R. at pass band	2.0 max.
Attenuation	40 dB min. (800 - 960 MHz)
	30 dB min. (1710 - 1990 MHz)
	25 dB min. (2110 - 2170 MHz)
	30 dB min. (4800 - 5000 MHz)
	30 dB min. (7200 - 7500 MHz)
Impedance	50 Ω

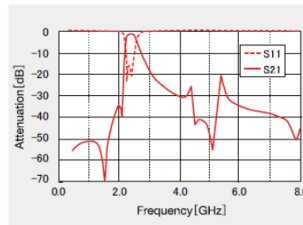

FI 212B245027

Pass band frequency	2400 - 2500 MHz
Insertion loss at pass band	1.4 dB max. (+25°C)
	1.7 dB max. (-40~+85°C)
Ripple at pass band	1.0 dB max.
V.S.W.R. at pass band	2.0 max.
Attenuation	30 dB min. (800 - 915 MHz)
	30 dB min. (1710 - 1910 MHz)
	6 dB min. (2110 - 2170 MHz)
	20 dB min. (4800 - 5000 MHz)

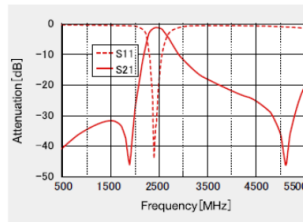

FI 168B245001

Pass band frequency	2400 - 2500 MHz
Insertion loss at pass band	2.2 dB max. (+25°C)
	2.5 dB max. (-30~+85°C)
Ripple at pass band	1.0 dB max.
V.S.W.R. at pass band	2.1 max.
Attenuation	25 dB min. (800 - 960 MHz)
	25 dB min. (1710 - 1910 MHz)
	20 dB min. (4800 - 5000 MHz)
	20 dB min. (7200 - 7500 MHz)
Impedance	50 Ω

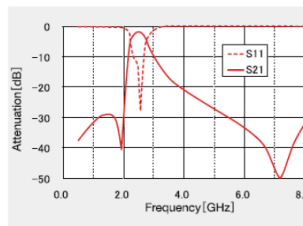

FI 105B245024

Pass band frequency	2400 - 2500 MHz
Insertion loss at pass band	3.0 dB max. (+25°C)
	3.3 dB max. (-40~+85°C)
Ripple at pass band	1.0 dB max.
V.S.W.R. at pass band	2.2 max.
Attenuation	25 dB min. (800 - 960 MHz)
	22 dB min. (1710 - 1910 MHz)
	20 dB min. (4800 - 5000 MHz)
	20 dB min. (7200 - 7500 MHz)

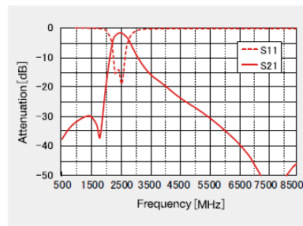

FI 168L062005

Pass band frequency	470 - 770 MHz
Insertion loss at 470 - 600 MHz	1.2 dB max. (+25°C)
	1.3 dB max. (-30~+85°C)
Insertion loss at 600 - 710 MHz	2.2 dB max. (+25°C)
	2.4 dB max. (-30~+85°C)
Insertion loss at 710 - 770 MHz	4.0 dB max. (+25°C)
	4.4 dB max. (-30~+85°C)
Ripple at 470 - 710 MHz	1.4 dB max.
V.S.W.R.	2.0 max. (470 - 710 MHz)
	2.5 max. (710 - 770 MHz)
Attenuation	25 dB min. (888 - 925 MHz) (+25°C)
	21 dB min. (888 - 925 MHz) (-30~+85°C)
	25 dB min. (940 - 960 MHz)
	27 dB min. (1429 - 1453 MHz)
	26 dB min. (1920 - 1980 MHz)
	26 dB min. (2400 - 2500 MHz)
Impedance	50 Ω

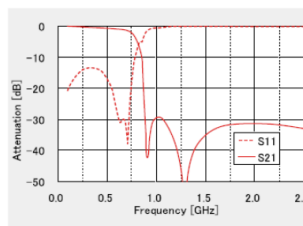

FI 105L250014

Pass band frequency	2400 - 2500 MHz
Insertion loss at 2400 - 2500 MHz	0.45 dB max. (+25°C)
	0.55 dB max. (-40~+85°C)
V.S.W.R. at 2400 - 2500 MHz	1.7 max.
Attenuation	21 dB min. (4800 - 5000 MHz)
	21 dB min. (7200 - 7500 MHz)
Impedance	50 Ω

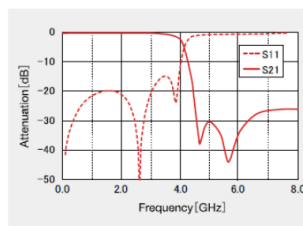

► This catalog contains the typical specification only due to the limitation of space. When you consider the purchase of our products, please check our product specification sheets. For details of each product (characteristics graph, reliability information, precautions for use, and so on), see our website (<http://www.ty-top.com/>).

ELECTRICAL CHARACTERISTICS / TYPICAL CHARACTERISTICS

FI 105L186822

Pass band frequency	824 - 915 MHz
Insertion loss at 824 - 915 MHz	0.75 dB max. (-30~+85°C)
V.S.W.R. at 2400 - 2500 MHz	1.5 max.
Attenuation	23 dB min. (1648 - 1830 MHz) 23 dB min. (2472 - 2745 MHz)
Impedance	50 Ω

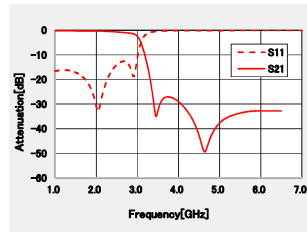

FI 105L087038

Pass band frequency	824 - 915 MHz
Insertion loss at 824 - 915 MHz	0.75 dB max. (-30~+85°C)
V.S.W.R. at 2400 - 2500 MHz	1.5 max.
Attenuation	23 dB min. (1648 - 1830 MHz) 23 dB min. (2472 - 2745 MHz)
Impedance	50 Ω

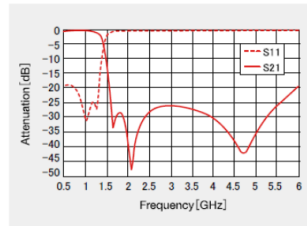

FI 168L0628M4

Pass band frequency	470 - 787 MHz
Insertion loss at pass band	0.5 dB max. (+25°C) 0.6 dB max. (-40~+90°C)
Ripple at pass band	-
V.S.W.R. at pass band	2.0 max.
Attenuation	26 dB min. (1429 - 1501 MHz) 30 dB min. (1565 - 1607 MHz) 35 dB min. (1570 - 1580 MHz) 18 dB min. (1920 - 1980 MHz)
Impedance	50 Ω

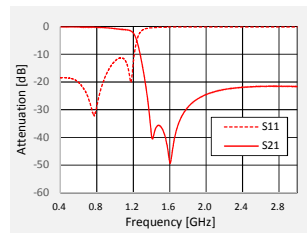

FI 168L2200G9

Pass band frequency	1700 - 2170 MHz 2170 - 2500 MHz 2500 - 2700 MHz
Insertion loss at 1700 - 2170 MHz	0.5 dB max. (+25°C)
Insertion loss at 2170 - 2500 MHz	0.55 dB max. (-30~+85°C)
Insertion loss at 2500 - 2700 MHz	0.65 dB max. (+25°C) 0.75 dB max. (-30~+85°C)
Return loss. at 1700 - 2700 MHz	10 dB min.
Attenuation	25 dB min. (3400 MHz) 22 dB min. (3400 - 5400 MHz) 20 dB min. (5400 - 8100 MHz)
Impedance	50 Ω

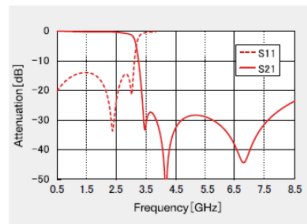

FI 168L1681G6

Pass band frequency	617 - 2690 MHz
Return loss. at 617 - 2690 MHz	0.5 dB max. (-40~+90°C) 10 dB min.
Attenuation	35 dB min. (4950 - 6000 MHz) 35 dB min. (6000 - 7500 MHz) 35 dB min. (7500 - 8100 MHz) 35 dB min. (8100 - 10500 MHz) 27 dB min. (10500 - 12500 MHz)
Impedance	50 Ω

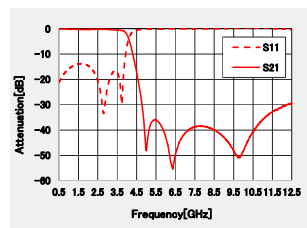

FI 168H2593GG

Pass band frequency	2496 - 2690 MHz
Insertion loss at 2500 - 2700 MHz	0.9 dB max. (-40~+90°C)
Return loss. at 1700 - 2700 MHz	15 dB min.
Attenuation	25 dB min. (1710 - 1995 MHz)
Impedance	50 Ω

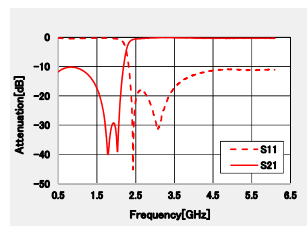

▶ This catalog contains the typical specification only due to the limitation of space. When you consider the purchase of our products, please check our product specification sheets. For details of each product (characteristics graph, reliability information, precautions for use, and so on), see our website (<http://www.ty-top.com/>).

ELECTRICAL CHARACTERISTICS / TYPICAL CHARACTERISTICS

FI 168D087018

Low band	
Pass band frequency	824 - 915 MHz
Insertion loss at 824 - 915 MHz	0.6 dB max. (-30~+85°C)
V.S.W.R. at 824 - 915 MHz	1.5 max.
Attenuation	25 dB min. (1648 - 1830 MHz) 25 dB min. (2472 - 2745 MHz)
Impedance	50 Ω
High band	
Pass band frequency	1710 - 1910 MHz
Insertion loss at 1710 - 1910 MHz	0.6 dB max. (-30~+85°C)
V.S.W.R. at 824 - 915 MHz	1.5 max.
Attenuation	25 dB min. (3420 - 3820 MHz) 25 dB min. (5130 - 5730 MHz)
Impedance	50 Ω
Isolation	
In to In/Out to Out	27 dB min. (824 - 915 MHz) 30 dB min. (1710 - 1910 MHz)
In to Out	30 dB min. (824 - 915 MHz) 30 dB min. (1710 - 1910 MHz)

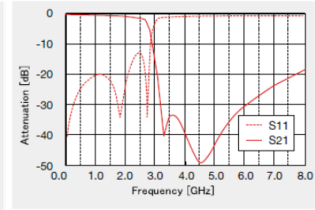
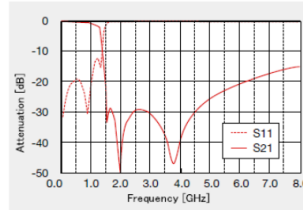

FI 212C245033

Pass band frequency	2400 - 2500 MHz
Insertion loss at pass band	2.7 dB (+25°C) 3.0 dB (-30~+85°C)
Ripple at pass band	1.0 dB max.
Unbalanced port V.S.W.R. at pass band	2.0 max.
Balanced port V.S.W.R. at pass band	2.0 max.
Amplitude Imbalance at pass band	2.0 dB max.
Phase Imbalance at pass band	180 ± 10°C
Attenuation	25 dB min. (880 - 960 MHz) 15 dB min. (1710 - 1990 MHz) 15 dB min. (1990 - 2170 MHz) 15 dB min. (4800 - 5000 MHz)
Unbalanced port Impedance	50 Ω
Balanced port Impedance	Conjugated match to CSR BC3

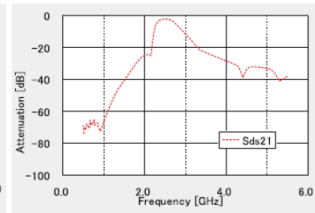
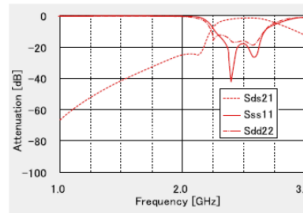

FI 212C245036

Pass band frequency	2400 - 2500 MHz
Insertion loss at pass band	3.7 dB (+25°C) 4.0 dB (-30~+85°C)
Ripple at pass band	1.0 dB max.
Unbalanced port V.S.W.R. at pass band	2.0 max.
Balanced port V.S.W.R. at pass band	2.0 max.
Amplitude Imbalance at pass band	2.0 dB max.
Phase Imbalance at pass band	180 ± 10°C
Attenuation	35 dB min. (880 - 960 MHz) 20 dB min. (1710 - 1990 MHz) 15 dB min. (1990 - 2170 MHz) 20 dB min. (4800 - 5000 MHz)
Unbalanced port Impedance	50 Ω
Balanced port Impedance	Conjugated match to CSR BC5

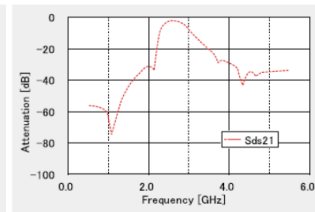
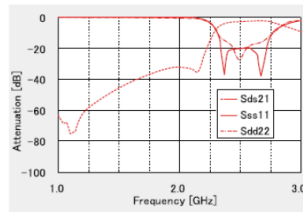

FI 212C245075

Pass band frequency	2400 - 2500 MHz
Insertion loss at pass band	3.7 dB (+25°C) 4.0 dB (-30~+85°C)
Ripple at pass band	1.0 dB max.
Unbalanced port V.S.W.R. at pass band	2.2 max.
Balanced port V.S.W.R. at pass band	2.2 max.
Amplitude Imbalance at pass band	2.0 dB max.
Phase Imbalance at pass band	180 ± 10°C
Attenuation	40 dB min. (880 - 960 MHz) 18 dB min. (1710 - 1990 MHz) 12 dB min. (1990 - 2170 MHz) 30 dB min. (4800 - 5000 MHz)
Unbalanced port Impedance	50 Ω
Balanced port Impedance	Conjugated match to CSR BC5FM, BC6ROM

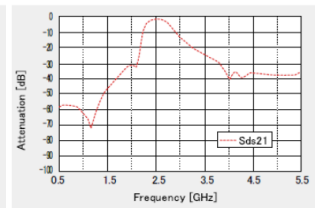
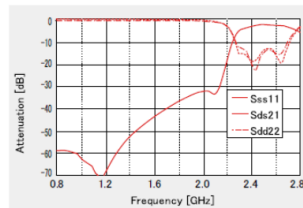

► This catalog contains the typical specification only due to the limitation of space. When you consider the purchase of our products, please check our product specification sheets. For details of each product (characteristics graph, reliability information, precautions for use, and so on), see our website (<http://www.ty-top.com/>).

ELECTRICAL CHARACTERISTICS / TYPICAL CHARACTERISTICS

FI 168P245030

Low band

Pass band frequency 1	1558 - 1610 MHz
Pass band frequency 2	2400 - 2500 MHz
Insertion loss at Pass band 1	0.50 dB max.
Insertion loss at Pass band 2	0.60 dB max.
V.S.W.R. at Pass band	2.0 dB max.
Attenuation	24 dB min. (4800 - 4900 MHz) 26 dB min. (4900 - 6000 MHz)
Impedance	50 Ω

High band

Pass band frequency	4900 - 5950 MHz
Insertion loss at Pass band	0.80 dB max.
V.S.W.R. at Pass band	2.0 dB max.
Attenuation	32 dB min. (30 - 2700 MHz)
Impedance	50 Ω

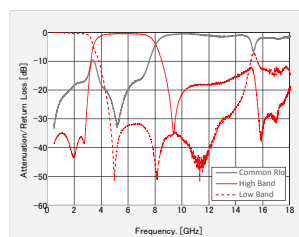

FI 212P082931

Low band

Pass band frequency 1	698 - 894 MHz
Pass band frequency 2	880 - 960 MHz
Insertion loss at 698 - 894 MHz	0.50 dB max. (+25°C) 0.60 dB max. (-40~+85°C)
Insertion loss at 880 - 960 MHz	0.70 dB max. (+25°C) 0.80 dB max. (-40~+85°C)
V.S.W.R. at 698 - 894 MHz	2.0 max.
V.S.W.R. at 880 - 960 MHz	2.0 max.
Attenuation	13 dB min. (1420 - 2690 MHz)
Impedance	50 Ω

High band

Pass band frequency 1	1420 - 1520 MHz
Pass band frequency 2	1560 - 1610 MHz
Pass band frequency 3	1710 - 2170 MHz
Pass band frequency 4	2300 - 2690 MHz
Insertion loss at 1420 - 1520 MHz	0.70 dB max. (+25°C) 0.80 dB max. (-40~+85°C)
Insertion loss at 1560 - 1610 MHz	0.50 dB max. (+25°C) 0.60 dB max. (-40~+85°C)
Insertion loss at 1710 - 2170 MHz	0.50 dB max. (+25°C) 0.60 dB max. (-40~+85°C)
Insertion loss at 2300 - 2690 MHz	0.50 dB max. (+25°C) 0.60 dB max. (-40~+85°C)
V.S.W.R. at 1420 - 2690 MHz	2.0 max.
Attenuation	13 dB min. (698 - 960 MHz)
Impedance	50 Ω

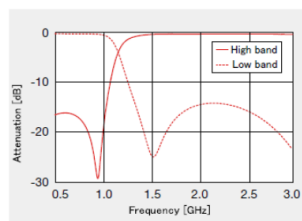

FI 212P0829G2

Low band

Pass band frequency	698 - 960 MHz
Insertion loss at 698 - 960 MHz	0.27 dB max. (+25°C) 0.32 dB max. (-40~+85°C)
V.S.W.R. at 698 - 960 MHz	2.0 max.
Attenuation	13 dB min. (1710 - 2690 MHz)
Impedance	50 Ω

High band

Pass band frequency	1710 - 2690 MHz
Insertion loss at 1710 - 2690 MHz	0.45 dB max. (+25°C) 0.55 dB max. (-40~+85°C)
V.S.W.R. at 698 - 960 MHz	2.0 max.
Attenuation	19 dB min. (698 - 960 MHz)
Impedance	50 Ω

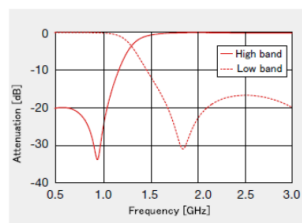

▶ This catalog contains the typical specification only due to the limitation of space. When you consider the purchase of our products, please check our product specification sheets. For details of each product (characteristics graph, reliability information, precautions for use, and so on), see our website (<http://www.ty-top.com/>).

■ ELECTRICAL CHARACTERISTICS / TYPICAL CHARACTERISTICS

FI 212P082934

Low band	
Pass band frequency	698 - 960 MHz
Insertion loss at 698 - 960 MHz	0.50 dB max. (-40~+85°C)
V.S.W.R. at 698 - 960 MHz	1.4 max.
Attenuation	15 dB min. (1554 - 1580 MHz)
	25 dB min. (1710 - 2110 MHz)
	25 dB min. (2110 - 2155 MHz)
	25 dB min. (2155 - 2690 MHz)
	12 dB min. (2155 - 7830 MHz)
Impedance	50 Ω
High band	
Pass band frequency 1	1710 - 2170 MHz
Pass band frequency 2	2500 - 2690 MHz
Insertion loss at 1710 - 2170 MHz	0.50 dB max. (-40~+85°C)
Insertion loss at 2500 - 2690 MHz	0.55 dB max. (-40~+85°C)
V.S.W.R. at 1710 - 2170 MHz	1.4 max.
V.S.W.R. at 2500 - 2690 MHz	1.8 max.
Attenuation	17 dB min. (0.3 - 960 MHz)
Impedance	50 Ω

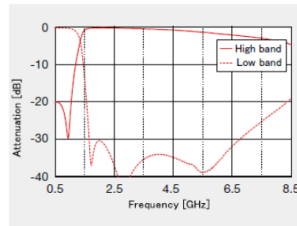

FI 212P082935

Low band	
Pass band frequency	698 - 960 MHz
Insertion loss at 698 - 960 MHz	0.50 dB max. (-40~+85°C)
V.S.W.R. at 698 - 960 MHz	1.4 max.
Attenuation	15 dB min. (1554 - 1580 MHz)
	25 dB min. (1710 - 2110 MHz)
	25 dB min. (2110 - 2155 MHz)
	25 dB min. (2155 - 2690 MHz)
	12 dB min. (2155 - 7830 MHz)
Impedance	50 Ω
High band	
Pass band frequency 1	1710 - 2170 MHz
Pass band frequency 2	2500 - 2690 MHz
Insertion loss at 1710 - 2170 MHz	0.50 dB max. (-40~+85°C)
Insertion loss at 2500 - 2690 MHz	0.55 dB max. (-40~+85°C)
V.S.W.R. at 1710 - 2170 MHz	1.4 max.
V.S.W.R. at 2500 - 2690 MHz	1.8 max.
Attenuation	17 dB min. (0.3 - 960 MHz)
Impedance	50 Ω

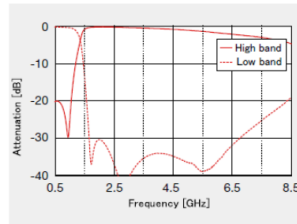

FI 212P089208

Low band	
Pass band frequency	698 - 960 MHz
Insertion loss at 698 - 960 MHz	0.27 dB max. (+25°C) 0.32 dB max. (-40~+85°C)
V.S.W.R. at 698 - 960 MHz	2.0 max.
Attenuation	13 dB min. (1710 - 2170 MHz)
Impedance	50 Ω
High band	
Pass band frequency	1710 - 2170 MHz
Insertion loss at 1710 - 2170 MHz	0.45 dB max. (+25°C) 0.55 dB max. (-40~+85°C)
V.S.W.R. at 698 - 960 MHz	2.0 max.
Attenuation	19 dB min. (698 - 960 MHz)
Impedance	50 Ω

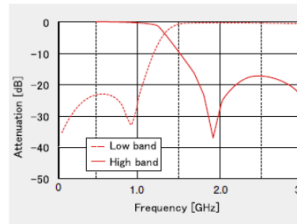

FI 212P089213

Low band	
Pass band frequency	698 - 960 MHz
Insertion loss at 698 - 960 MHz	0.27 dB max. (+25°C) 0.32 dB max. (-40~+85°C)
V.S.W.R. at 698 - 960 MHz	2.0 max.
Attenuation	13 dB min. (1710 - 2170 MHz)
Impedance	50 Ω
High band	
Pass band frequency	1710 - 2170 MHz
Insertion loss at 1710 - 2170 MHz	0.45 dB max. (+25°C) 0.55 dB max. (-40~+85°C)
V.S.W.R. at 698 - 960 MHz	2.0 max.
Attenuation	19 dB min. (698 - 960 MHz)
Impedance	50 Ω

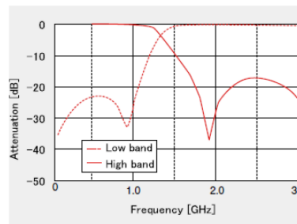

▶ This catalog contains the typical specification only due to the limitation of space. When you consider the purchase of our products, please check our product specification sheets. For details of each product (characteristics graph, reliability information, precautions for use, and so on), see our website (<http://www.ty-top.com/>).

ELECTRICAL CHARACTERISTICS / TYPICAL CHARACTERISTICS

FI 212P085909

Low band	
Pass band frequency	698 - 960 MHz
Insertion loss at 698 - 960 MHz	0.70 dB max. (+25°C) 0.75 dB max. (-30~+85°C)
V.S.W.R. at 698 - 960 MHz	1.6 max.
Attenuation	19 dB min. (1558 - 1570 MHz) 20 dB min. (1570 - 1580 MHz) 19 dB min. (1580 - 1610 MHz)
Impedance	50 Ω
High band	
Pass band frequency 1	1558 - 1570 MHz
Pass band frequency 2	1570 - 1580 MHz
Pass band frequency 3	1580 - 1610 MHz
Insertion loss at 1558 - 1570 MHz	0.75 dB max. (+25°C) 0.85 dB max. (-30~+85°C)
Insertion loss at 1570 - 1580 MHz	0.70 dB max. (+25°C) 0.80 dB max. (-30~+85°C)
Insertion loss at 1580 - 1610 MHz	0.70 dB max. (+25°C) 0.80 dB max. (-30~+85°C)
V.S.W.R. at 1558 - 1570 MHz	1.6 max.
V.S.W.R. at 1570 - 1580 MHz	1.6 max.
V.S.W.R. at 1580 - 1610 MHz	1.6 max.
Attenuation	35 dB min. (698 - 824 MHz) 42 dB min. (824 - 894 MHz) 25 dB min. (894 - 960 MHz)
Impedance	50 Ω

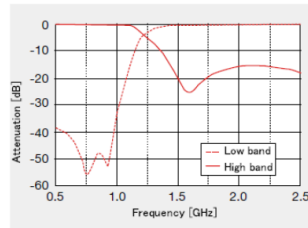

FI 212P085912

Low band	
Pass band frequency	698 - 960 MHz
Insertion loss at 698 - 960 MHz	0.70 dB max. (+25°C) 0.75 dB max. (-30~+85°C)
V.S.W.R. at 698 - 960 MHz	1.6 max.
Attenuation	19 dB min. (1558 - 1570 MHz) 20 dB min. (1570 - 1580 MHz) 19 dB min. (1580 - 1610 MHz)
Impedance	50 Ω
High band	
Pass band frequency 1	1558 - 1570 MHz
Pass band frequency 2	1570 - 1580 MHz
Pass band frequency 3	1580 - 1610 MHz
Insertion loss at 1558 - 1570 MHz	0.75 dB max. (+25°C) 0.85 dB max. (-30~+85°C)
Insertion loss at 1570 - 1580 MHz	0.70 dB max. (+25°C) 0.80 dB max. (-30~+85°C)
Insertion loss at 1580 - 1610 MHz	0.70 dB max. (+25°C) 0.80 dB max. (-30~+85°C)
V.S.W.R. at 1558 - 1570 MHz	1.6 max.
V.S.W.R. at 1570 - 1580 MHz	1.6 max.
V.S.W.R. at 1580 - 1610 MHz	1.6 max.
Attenuation	35 dB min. (698 - 824 MHz) 42 dB min. (824 - 894 MHz) 25 dB min. (894 - 960 MHz)
Impedance	50 Ω

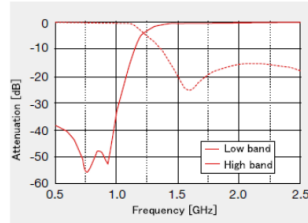

FI 168P157519

Low band	
Pass band frequency 0	824 - 960 MHz
Pass band frequency 1	1558 - 1585 MHz
Pass band frequency 2	1585 - 1610 MHz
Insertion loss at 824 - 960 MHz	0.50 dB max. (+25°C) 0.60 dB max. (-40~+85°C)
Insertion loss at 1558 - 1585 MHz	0.40 dB max. (+25°C) 0.50 dB max. (-40~+85°C)
Insertion loss at 1585 - 1610 MHz	0.45 dB max. (+25°C) 0.55 dB max. (-40~+85°C)
V.S.W.R. at 824 - 960 MHz	2.0 max.
V.S.W.R. at 1558 - 1585 MHz	2.0 max.
V.S.W.R. at 1585 - 1610 MHz	2.0 max.
Attenuation	13 dB min. (2400 - 2500 MHz)
Impedance	50 Ω
High band	
Pass band frequency	2400 - 2500 MHz
Insertion loss at 2400 - 2500 MHz	0.60 dB max. (+25°C) 0.70 dB max. (-40~+85°C)
V.S.W.R. at 2400 - 2500 MHz	2.0 max.
Attenuation	12 dB min. (824 - 960 MHz) 23 dB min. (1558 - 1585 MHz) 20 dB min. (1585 - 1610 MHz)
Impedance	50 Ω

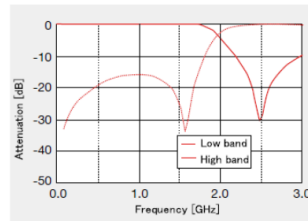

▶ This catalog contains the typical specification only due to the limitation of space. When you consider the purchase of our products, please check our product specification sheets. For details of each product (characteristics graph, reliability information, precautions for use, and so on), see our website (<http://www.ty-top.com/>).

■ ELECTRICAL CHARACTERISTICS / TYPICAL CHARACTERISTICS

FI 168P157525

Low band

Pass band frequency 0	824 - 960 MHz
Pass band frequency 1	1558 - 1585 MHz
Pass band frequency 2	1585 - 1610 MHz
Insertion loss at 824 - 960 MHz	0.50 dB max. (+25°C)
	0.60 dB max. (-40~+85°C)
Insertion loss at 1558 - 1585 MHz	0.40 dB max. (+25°C)
	0.50 dB max. (-40~+85°C)
Insertion loss at 1585 - 1610 MHz	0.45 dB max. (+25°C)
	0.55 dB max. (-40~+85°C)
V.S.W.R. at 824 - 960 MHz	2.0 max.
V.S.W.R. at 1558 - 1585 MHz	2.0 max.
V.S.W.R. at 1585 - 1610 MHz	2.0 max.
Attenuation	13 dB min. (2400 - 2500 MHz)
Impedance	50 Ω

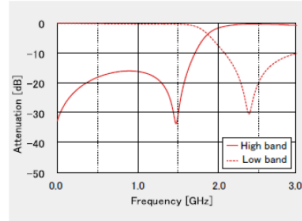

High band

Pass band frequency	2400 - 2500 MHz
Insertion loss at 2400 - 2500 MHz	0.60 dB max. (+25°C)
	0.70 dB max. (-40~+85°C)
V.S.W.R. at 2400 - 2500 MHz	2.0 max.
Attenuation	12 dB min. (824 - 960 MHz)
	23 dB min. (1558 - 1585 MHz)
	12 dB min. (1585 - 1610 MHz)
Impedance	50 Ω

FI 168W1697B1

Pass band frequency	699 - 2690 MHz
Insertion loss at 699 - 960 MHz	0.15 dB max. (+35~+85°C)
	0.1 dB max. (+15~+35°C)
	0.1 dB max. (-20~+15°C)
Insertion loss at 1000 - 2025 MHz	0.25 dB max. (+35~+85°C)
	0.2 dB max. (+15~+35°C)
	0.2 dB max. (-20~+15°C)
Insertion loss at 2110 - 2690 MHz	0.38 dB max. (+35~+85°C)
	0.28 dB max. (+15~+35°C)
	0.28 dB max. (-20~+15°C)
Ripple	0.1 dB max. (699 - 746 MHz)
	0.1 dB max. (791 - 862 MHz)
	0.1 dB max. (824 - 960 MHz)
	0.1 dB max. (1710 - 2170 MHz)
	0.1 dB max. (2500 - 2690 MHz)
RF Coupling	28.1~29.5 dB (699MHz)
	25.8~27.2 dB (915MHz)
	20.7~22.1 dB (1710MHz)
	19.9~21.3 dB (1880MHz)
	19.3~20.7 dB (2025MHz)
	18.3~19.7 dB (2300MHz)
17.1~18.5 dB (2690MHz)	
Coupling ration mismatch between Coupler branch 1 and Coupler branch 2	-1~1 dB (699 - 2690 MHz)
Directivity	18 dB min. (699 - 2690 MHz)
Impedance	50 Ω

FI 168K1687AA

Pass band frequency	698 - 2690 MHz
Insertion loss at 699 - 2690 MHz	0.25 dB max. (+25°C)
	0.30 dB max. (-40~+85°C)
S11 Coupled port at 698 - 2690 MHz	0.25 dB max. (+25°C)
RF Coupling	26.5~29.0 dB (698MHz)
	24.0~27.0 dB (915MHz)
	21.5~24.5 dB (1710MHz)
	21.5~24.5 dB (2025MHz)
	21.5~24.5 dB (2300MHz)
	21.5~25.5 dB (2690MHz)
Isolation	35 dB min. (698 - 2690 MHz)
Impedance	50 Ω

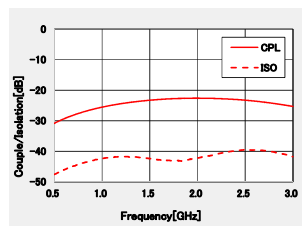

▶ This catalog contains the typical specification only due to the limitation of space. When you consider the purchase of our products, please check our product specification sheets. For details of each product (characteristics graph, reliability information, precautions for use, and so on), see our website (<http://www.ty-top.com/>).

MULTILAYER CERAMIC DEVICES / DIPLEXERS / COUPLER / 2 BRANCH COUPLER

PACKAGING

① Minimum Quantity

Type	Embossed tape / Paper tape [pcs]
212B	3000
212C	
212P	
168B	4000
168L	
168D	
168P	
168L-G	5000
168H	
168W	8000
168K	
105B	10000
105L	

② Tape Material

● Embossed Tape

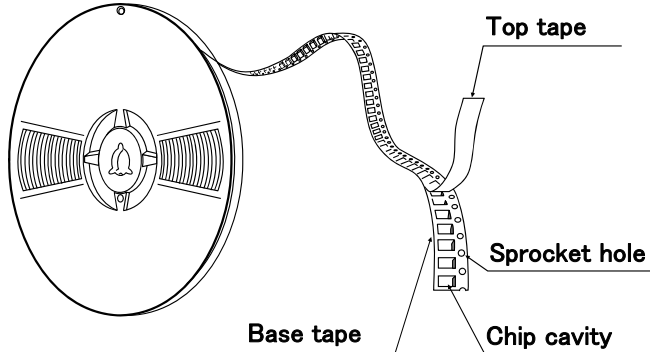

● Card Board Carrier Tape

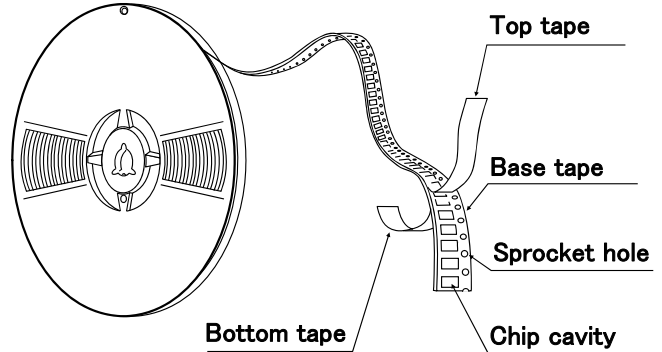

Chip Filled

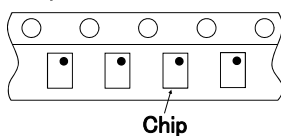

● Taped package

Type	Thickness mm (inch)	Standard Quantity [pcs]
212B	0.90 typ.(0.035)	3000
212C	0.90 typ.(0.035)	
212P	0.90 typ.(0.035)	
212C-0.7	0.60 typ.(0.024)	4000
168B	0.45 typ.(0.018)	
168L-0.5	0.45 typ.(0.018)	
168L-0.65	0.60 typ.(0.024)	
168D	0.45 typ.(0.018)	5000
168P	0.60 typ.(0.024)	
168L-G	0.60 typ.(0.024)	8000
168H	0.60 typ.(0.024)	
168W	0.45 typ.(0.018)	10000
168K	0.60 typ.(0.024)	
105B	0.30 typ.(0.0118)	
105L	0.30 typ.(0.0118)	

▶ This catalog contains the typical specification only due to the limitation of space. When you consider the purchase of our products, please check our specification. For details of each product (characteristics graph, reliability information, precautions for use, and so on), see our Web site (<http://www.ty-top.com/>).

③ Taping Dimensions

● Embossed tape 0.315 inches wide

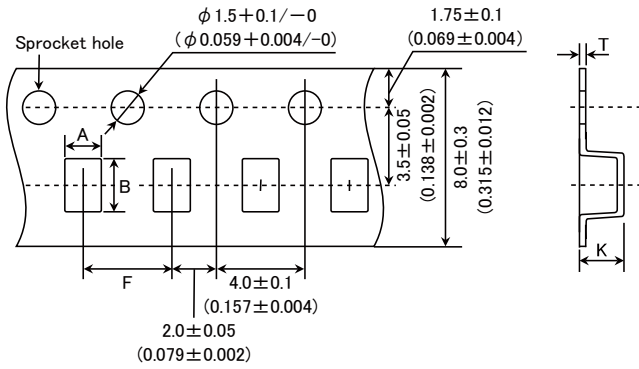

Unit: mm (inch)

Type	Chip cavity		Insertion Pitch	Tape Thickness max.	
	A	B	F	K	T
212B	1.55 ± 0.2 (0.061 ± 0.008)	2.3 ± 0.2 (0.091 ± 0.008)	4.0 ± 0.1 (0.157 ± 0.004)	1.6 (0.063)	0.3 (0.012)
212C	1.55 ± 0.2 (0.061 ± 0.008)	2.3 ± 0.2 (0.091 ± 0.008)	4.0 ± 0.1 (0.157 ± 0.004)	1.6 (0.063)	0.3 (0.012)
212C-0.7	1.55 ± 0.2 (0.061 ± 0.008)	2.3 ± 0.2 (0.091 ± 0.008)	4.0 ± 0.1 (0.157 ± 0.004)	1.3 (0.051)	0.3 (0.012)
212P	1.55 ± 0.2 (0.061 ± 0.008)	2.3 ± 0.2 (0.091 ± 0.008)	4.0 ± 0.1 (0.157 ± 0.004)	1.6 (0.063)	0.3 (0.012)

Unit: mm (inch)

● Paper tape 0.315 inches wide

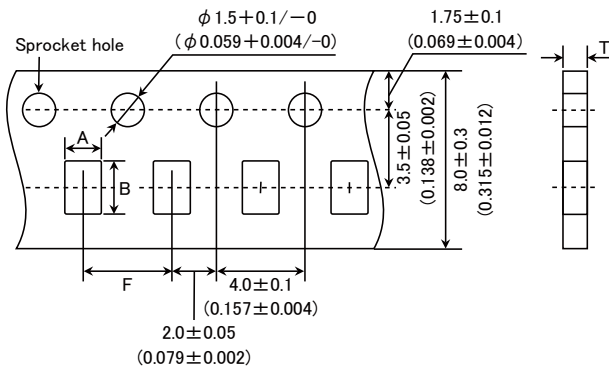

Unit: mm (inch)

Type	Chip cavity		Insertion Pitch	Tape Thickness max.
	A	B	F	T
168B	1.00 ± 0.05 (0.039 ± 0.002)	1.80 ± 0.05 (0.071 ± 0.002)	4.0 ± 0.1 (0.157 ± 0.004)	0.55 (0.022)
168L	1.00 ± 0.05 (0.039 ± 0.002)	1.80 ± 0.05 (0.071 ± 0.002)	4.0 ± 0.1 (0.157 ± 0.004)	0.55 (0.022)
168W	1.00 ± 0.05 (0.039 ± 0.002)	1.80 ± 0.05 (0.071 ± 0.002)	4.0 ± 0.1 (0.157 ± 0.004)	0.55 (0.022)
168K	1.00 ± 0.05 (0.039 ± 0.002)	1.80 ± 0.05 (0.071 ± 0.002)	4.0 ± 0.1 (0.157 ± 0.004)	0.80 (0.031)
168D	1.00 ± 0.05 (0.039 ± 0.002)	1.80 ± 0.05 (0.071 ± 0.002)	4.0 ± 0.1 (0.157 ± 0.004)	0.55 (0.022)
168P	0.95 ± 0.05 (0.037 ± 0.002)	1.80 ± 0.05 (0.071 ± 0.002)	4.0 ± 0.1 (0.157 ± 0.004)	0.80 (0.031)
168L-G	0.95 ± 0.05 (0.037 ± 0.002)	1.80 ± 0.05 (0.071 ± 0.002)	4.0 ± 0.1 (0.157 ± 0.004)	0.80 (0.031)
168H	0.95 ± 0.05 (0.037 ± 0.002)	1.80 ± 0.05 (0.071 ± 0.002)	4.0 ± 0.1 (0.157 ± 0.004)	0.80 (0.031)
105B	0.62 ± 0.03 (0.024 ± 0.001)	1.12 ± 0.03 (0.044 ± 0.001)	2.0 ± 0.05 (0.079 ± 0.002)	0.45 (0.018)
105L	0.62 ± 0.03 (0.024 ± 0.001)	1.12 ± 0.03 (0.044 ± 0.001)	2.0 ± 0.05 (0.079 ± 0.002)	0.45 (0.018)

Unit: mm (inch)

▶ This catalog contains the typical specification only due to the limitation of space. When you consider the purchase of our products, please check our specification. For details of each product (characteristics graph, reliability information, precautions for use, and so on), see our Web site (<http://www.ty-top.com/>).

④ Leader and Blank Portion

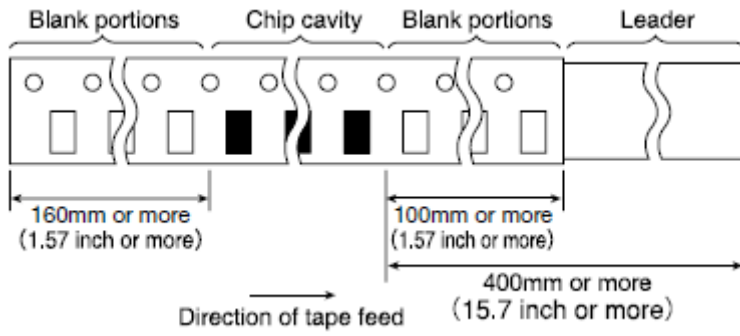

⑤ Reel size

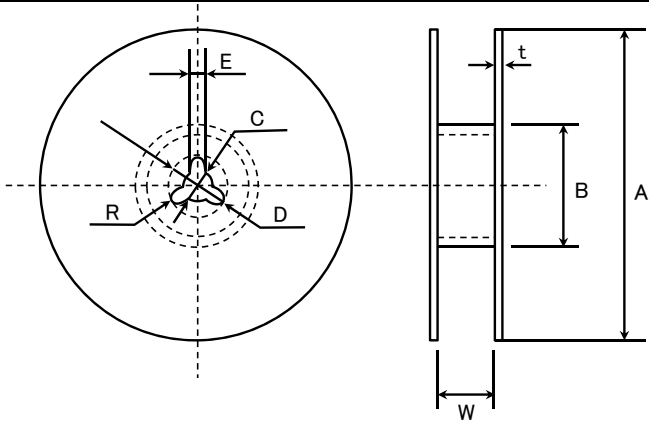

A	B	C	D	E	R
$\phi 178 \pm 2.0$ ($\phi 7.01 \pm 0.079$)	$\phi 50 \text{ min.}$ ($\phi 1.97 \text{ min.}$)	$\phi 13.0 \pm 0.2$ ($\phi 0.512 \pm 0.008$)	$\phi 21.0 \pm 0.8$ ($\phi 0.827 \pm 0.031$)	2.0 ± 0.5 (0.079 ± 0.020)	1.0
	t	W			
8mm width tape (0.315 inches width)	2.5max. (0.098max.)	10 ± 1.5 (0.394 ± 0.059)			
12mm width tape (0.472 inches width)	2.5max. (0.098max.)	14 ± 1.5 (0.551 ± 0.059)			

Unit: mm (inch)

⑥ Top Tape Strength

The top tape requires a peel-off force of 0.1~0.7N in the direction of the arrow as illustrated below.

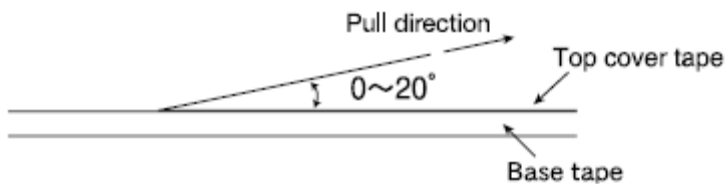

MULTILAYER CERAMIC DEVICES / DIPLEXERS / COUPLER / 2 BRANCH COUPLER

RELIABILITY DATA

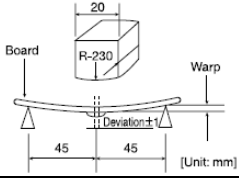
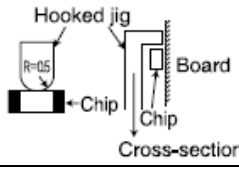
1. Operating Temperature Range	
Specified Value	-30~+85°C
2. Storage Temperature Range	
Specified Value	-30~+85°C
Test Methods and Remarks	※Note : -20 to +40°C in taped packaging
3. Resistance to Flexure of Substrate	
Specified Value	No mechanical damage.
Test Methods and Remarks	<p>Warp : 2mm Testing board : Glass epoxy-resin substrate Thickness : 0.8mm</p> 
4. Adhesion of Electrode	
Specified Value	Characteristics : shall satisfy the electrical characteristics. Appearance : No significant abnormality.
Test Methods and Remarks	<p>Applied force : 5N Duration : 10 sec.</p> 
5. Solderability	
Specified Value	75% or more of immersed surface of terminal electrode shall be covered with fresh solder.
Test Methods and Remarks	<p>Solder temperature : 230±5°C Duration : 4±1 sec Preconditioning : Immersion into flux. Immersion and Removal speed : 25mm/sec.</p>
6. Resistance to Solder Heat	
Specified Value	Characteristics : shall satisfy the electrical characteristics. Appearance : No significant abnormality.
Test Methods and Remarks	<p>Preheating : 150°C for 2 min. Solder temperature : 260±5°C Duration : 5±0.5 sec. Preconditioning : Immersion into flux. Immersion and Removal speed : 25mm/sec. Recovery : 2 to 3hrs of recovery under the standard condition after the removal from test chamber.</p>

▶ This catalog contains the typical specification only due to the limitation of space. When you consider the purchase of our products, please check our specification. For details of each product (characteristics graph, reliability information, precautions for use, and so on), see our Web site (<http://www.ty-top.com/>).

7. Thermal Shock																
Specified Value	Characteristics : shall satisfy the electrical characteristics. Appearance : No significant abnormality.															
Test Methods and Remarks	According to JIS C60068-2-14. Conditions for 1 cycle															
	<table border="1"> <thead> <tr> <th>Step</th> <th>Temperature (°C)</th> <th>Duration (min)</th> </tr> </thead> <tbody> <tr> <td>1</td> <td>-40±3</td> <td>30±3</td> </tr> <tr> <td>2</td> <td>Room Temperature</td> <td>Within 3</td> </tr> <tr> <td>3</td> <td>85±2</td> <td>30±3</td> </tr> <tr> <td>4</td> <td>Room Temperature</td> <td>Within 3</td> </tr> </tbody> </table>	Step	Temperature (°C)	Duration (min)	1	-40±3	30±3	2	Room Temperature	Within 3	3	85±2	30±3	4	Room Temperature	Within 3
	Step	Temperature (°C)	Duration (min)													
	1	-40±3	30±3													
	2	Room Temperature	Within 3													
3	85±2	30±3														
4	Room Temperature	Within 3														
Number of cycles : 100																
Mounting method : Soldering onto PC board. Recovery : 2 to 3hrs of recovery under the standard condition after the removal from test chamber.																

8. Humidity (steady state)	
Specified Value	Characteristics : shall satisfy the electrical characteristics. Appearance : No significant abnormality.
Test Methods and Remarks	Temperature : +40±2°C Humidity : 90~95%RH Duration : 96hrs Recovery : 2 to 3hrs of recovery under the standard condition after the removal from test chamber.

9. High temperature life test	
Specified Value	Characteristics : shall satisfy the electrical characteristics. Appearance : No significant abnormality.
Test Methods and Remarks	Temperature : +85±2°C Duration : 96hrs Recovery : 2 to 3hrs of recovery under the standard condition after the removal from test chamber.

10. Low temperature life test	
Specified Value	Characteristics : shall satisfy the electrical characteristics. Appearance : No significant abnormality.
Test Methods and Remarks	Temperature : -40±2°C Duration : 96hrs Recovery : 2 to 3hrs of recovery under the standard condition after the removal from test chamber.

Note on standard condition:

“standard condition” referred to herein is defined as follows :
5 to 35°C of temperature, 45 to 85% relative humidity and 86 to 106kPa of air pressure.

When there are questions concerning measurement result :

In order to provide correlation data, the test shall be conducted under condition of 20±2°C of temperature, 60 to 70% relative humidity and 86 to 106kPa of air pressure.

Unless otherwise specified, all the tests are conducted under the “standard condition”.

MULTILAYER CERAMIC DEVICES / DIPLEXERS / COUPLER / 2 BRANCH COUPLER

PRECAUTIONS

1. PCB Design

◆ Land pattern design

Land pattern dimension examples

Technical considerations

FI212B Type	FI168B/L Type	FI105B/L Type	FI168L/H LGA Type
<p>Unit: mm</p>	<p>Unit: mm</p>	<p>Unit: mm</p>	<p>Unit: mm</p>
FI168D/FI168K Type	FI212C Type	FI168P Type	FI212P Type
<p>Unit: mm</p>	<p>Unit: mm</p>	<p>Unit: mm</p>	<p>Unit: mm</p>
FI212P***G* Type	FI168W Type		
<p>Unit: mm</p>	<p>Unit: mm</p>		

2. Soldering

◆ Conditions for Reflow soldering (for reference)

【Reflow Profile】

Technical considerations

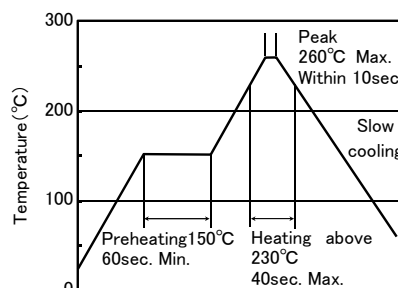
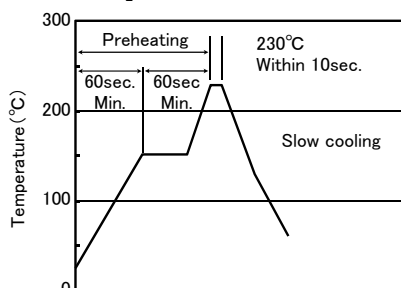

- ※ Components should be preheated to within 100 to 130°C from soldering temperature.
- ※ Assured to be reflow soldering for 2 times.

Note : The above profiles are the maximum allowable soldering condition, therefore these profiles are not always recommended.

3. Storage conditions

Precautions	<p>◆Storage</p> <p>1. To maintain the solderability of terminal electrodes and to keep the packaging material in good condition, care must be taken to control temperature and humidity in the storage area. Humidity should especially be kept as low as possible.</p> <ul style="list-style-type: none">• Recommended conditions Ambient temperature : $-20\sim+40^{\circ}\text{C}$ Humidity : Below 70%RH The ambient temperature must be kept below 30°C. Even under ideal storage conditions, the solderability of electrodes decreases gradually, so filters should be mounted within 6 months from the time of delivery.• The packaging material should be kept where no chlorine or sulfur exists in the air.
Technical considerations	<p>◆Storage</p> <p>1. If the parts are stocked in a high temperature and humidity environment, problems such as reduced solderability caused by oxidation of terminal electrodes and deterioration of taping/ packaging materials may take place. For this reason, components should be used within 6 months from the time of delivery. If exceeding the above period, please check the solderability before using the filter.</p>

- Please contact of our offices for further details of specifications.
All of the standard values listed here are subject to change without notice.
Therefore, please check the specifications carefully before use.

Компания «Океан Электроники» предлагает заключение долгосрочных отношений при поставках импортных электронных компонентов на взаимовыгодных условиях!

Наши преимущества:

- Поставка оригинальных импортных электронных компонентов напрямую с производств Америки, Европы и Азии, а так же с крупнейших складов мира;
- Широкая линейка поставок активных и пассивных импортных электронных компонентов (более 30 млн. наименований);
- Поставка сложных, дефицитных, либо снятых с производства позиций;
- Оперативные сроки поставки под заказ (от 5 рабочих дней);
- Экспресс доставка в любую точку России;
- Помощь Конструкторского Отдела и консультации квалифицированных инженеров;
- Техническая поддержка проекта, помощь в подборе аналогов, поставка прототипов;
- Поставка электронных компонентов под контролем ВП;
- Система менеджмента качества сертифицирована по Международному стандарту ISO 9001;
- При необходимости вся продукция военного и аэрокосмического назначения проходит испытания и сертификацию в лаборатории (по согласованию с заказчиком);
- Поставка специализированных компонентов военного и аэрокосмического уровня качества (Xilinx, Altera, Analog Devices, Intersil, Interpoint, Microsemi, Actel, Aeroflex, Peregrine, VPT, Syfer, Eurofarad, Texas Instruments, MS Kennedy, Miteq, Cobham, E2V, MA-COM, Hittite, Mini-Circuits, General Dynamics и др.);

Компания «Океан Электроники» является официальным дистрибьютором и эксклюзивным представителем в России одного из крупнейших производителей разъемов военного и аэрокосмического назначения «JONHON», а так же официальным дистрибьютором и эксклюзивным представителем в России производителя высокотехнологичных и надежных решений для передачи СВЧ сигналов «FORSTAR».



JONHON

«JONHON» (основан в 1970 г.)

Разъемы специального, военного и аэрокосмического назначения:

(Применяются в военной, авиационной, аэрокосмической, морской, железнодорожной, горно- и нефтедобывающей отраслях промышленности)

«FORSTAR» (основан в 1998 г.)

ВЧ соединители, коаксиальные кабели, кабельные сборки и микроволновые компоненты:

(Применяются в телекоммуникациях гражданского и специального назначения, в средствах связи, РЛС, а так же военной, авиационной и аэрокосмической отраслях промышленности).



Телефон: 8 (812) 309-75-97 (многоканальный)

Факс: 8 (812) 320-03-32

Электронная почта: ocean@oceanchips.ru

Web: <http://oceanchips.ru/>

Адрес: 198099, г. Санкт-Петербург, ул. Калинина, д. 2, корп. 4, лит. А