

Description

The BCR401U monolithically integrates a transistor, diodes and resistors to function as a Constant Current Regulator (CCR) for LED driving. The device regulates with a preset 10mA nominal that can be adjusted with external resistor up to 100mA. It is designed for driving LEDs in strings and will reduce current at increasing temperatures to self-protect. Operating as a series linear CCR for LED string current control, it can be used in applications with supply voltages up to 40V.

With no need for additional external components, this CCR is fully integrated into a SOT26 minimizing PCB area and component count.

Applications

Constant current regulation (CCR) in:

- Emergency lighting
- Signage, advertising, decorative and architectural lighting
- Retail lighting in fridge, freezer case and vending machines

Features

- LED Constant Current Regulator Using PNP Emitter-Follower with Emitter Resistor to Current Limit
- $I_{OUT} = 10\text{mA} \pm 10\%$ constant current (Preset)
- I_{OUT} up to 100mA adjustable with an external resistor
- Negative temperature coefficient (NTC) reduces I_{out} with increasing temperature
- Parallel devices to increase regulated current
- **Totally Lead-Free & Fully RoHS Compliant (Notes 1 & 2)**
- **Halogen and Antimony Free. "Green" Device (Note 3)**

Mechanical Data

- Case: SOT26 (SC-74)
- Case Material: Molded Plastic. "Green" Molding Compound. UL Flammability Rating 94V-0
- Moisture Sensitivity: Level 1 per J-STD-020
- Terminals: Finish - Matte Tin Plated Leads, Solderable per MIL-STD-202, Method 208 (E3)
- Weight: 0.018 grams (Approximate)

SOT26 (SC-74)



Top View

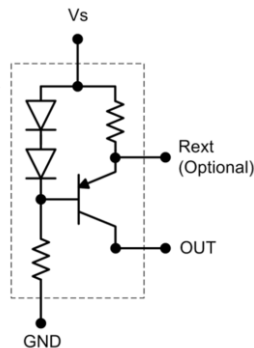

Internal Device Schematic

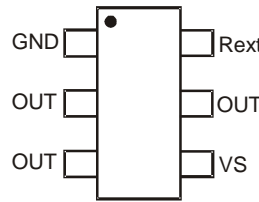

Top View Pin-Out

Pin Name	Pin Function
Vs	Supply Voltage
OUT	Regulated Output Current
Rext	External resistor for adjusting Output Current
GND	Power Ground

Ordering Information (Note 4)

Product	Marking	Reel size (inches)	Tape width (mm)	Quantity per reel
BCR401UW6-7	401	7	8	3,000

- Notes:
1. No purposely added lead. Fully EU Directive 2002/95/EC (RoHS) & 2011/65/EU (RoHS 2) compliant.
 2. See http://www.diodes.com/quality/lead_free.html for more information about Diodes Incorporated's definitions of Halogen- and Antimony-free, "Green" and Lead-free.
 3. Halogen- and Antimony-free "Green" products are defined as those which contain <900ppm bromine, <900ppm chlorine (<1500ppm total Br + Cl) and <1000ppm antimony compounds.
 4. For packaging details, go to our website at <http://www.diodes.com/products/packages.html>.

Marking Information

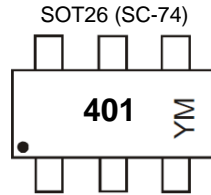

401 = Part Marking (See Ordering Information)
 YM = Date Code Marking
 Y = Year (ex: D = 2016)
 M = Month (ex: 9 = September)

Date Code Key

Year	2016	2017	2018	2019	2020	2021	2022
Code	D	E	F	G	H	I	J

Month	Jan	Feb	Mar	Apr	May	Jun	Jul	Aug	Sep	Oct	Nov	Dec
Code	1	2	3	4	5	6	7	8	9	O	N	D

Absolute Maximum Ratings (Voltage relative to GND, @T_A = +25°C, unless otherwise specified.)

Characteristic	Symbol	Value	Unit
Supply Voltage	V _S	40	V
Output Current	I _{OUT}	100	mA
Output Voltage	V _{OUT}	40	V
Reverse voltage between all terminals	V _R	0.5	V

Thermal Characteristics

Characteristic	Symbol	Value	Unit
Power Dissipation	P _D	(Note 5)	1,190
		(Note 6)	912
Thermal Resistance, Junction to Ambient	R _{θJA}	(Note 5)	105
		(Note 6)	137
Thermal Resistance, Junction to Lead	R _{θJL}	50	°C/W
Recommended Operating Junction Temperature Range	T _J	-55 to +150	
Maximum Operating Junction and Storage Temperature Range	T _J , T _{STG}	-65 to +150	

ESD Ratings (Note 8)

Characteristics	Symbols	Value	Unit	JEDEC Class
Electrostatic Discharge – Human Body Model	ESD HBM	800	V	1B
Electrostatic Discharge – Machine Model	ESD MM	300	V	B

- Notes:
- For a device mounted with the OUT leads on 50mm x 50mm 2oz copper that is on a single-sided 1.6mm FR4 PCB; device is measured under still air conditions while operating in steady-state.
 - Same as Note 5, except mounted on 15mm x 15mm 1oz copper.
 - R_{θJL} = Thermal resistance from junction to solder-point (at the end of the OUT leads).
 - Refer to JEDEC specification JESD22-A114 and JESD22-A115.

Electrical Characteristics (@T_A = +25°C, unless otherwise specified.)

Characteristic	Symbol	Min	Typ	Max	Unit	Test Condition
Collector-Emitter Breakdown Voltage	BV _{CEO}	40	-	-	V	I _C = 1mA
GND (Enable) Current	I _{GND}	340	420	500	μA	V _S = 10V; V _{OUT} = open
GND (Enable) Current	I _{GND}	-	380	-	μA	V _S = 10V; V _{OUT} = 8.6V
DC Current Gain	h _{FE}	100	220	470	-	I _C = 50mA; V _{CE} = 1V
Internal Resistor	R _{int}	78	91	104	Ω	I _{Rint} = 10mA
Output Current (nominal)	I _{OUT}	9	10	11	mA	V _{OUT} = 8.6V; V _S = 10V
Voltage Drop (V _{RExt})	V _{drop}	-	0.91	-	V	I _{OUT} = 10mA
Lowest Sufficient Supply Voltage (V _S -V _{OUT})	V _{Smin}	-	1.4	-	V	I _{OUT} > 8mA
Output Current Change vs. Temperature	ΔI _{OUT} /I _{OUT}	-	-0.25	-	%/°C	V _S = 10V
Output Current Change vs. Supply Voltage	ΔI _{OUT} /I _{OUT}	-	1	-	%/V	V _S = 10V

Typical Thermal Characteristics (@ $T_A = +25^\circ\text{C}$, unless otherwise specified.)

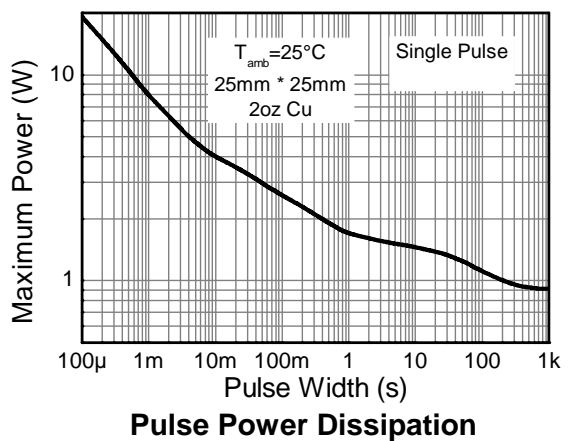
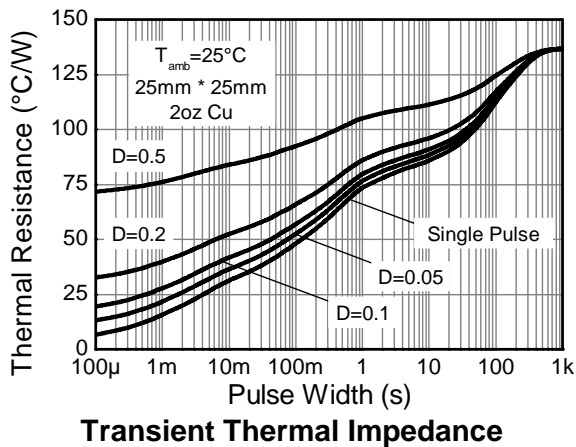
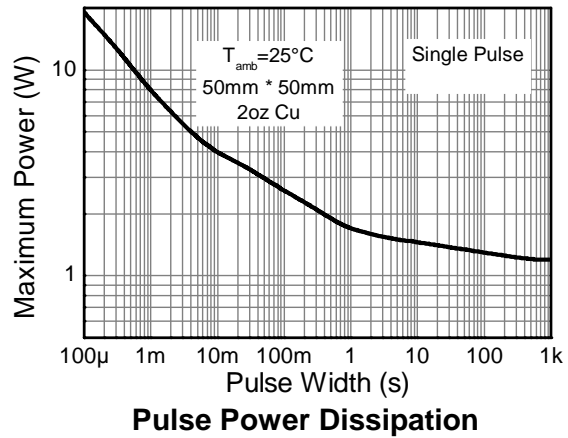
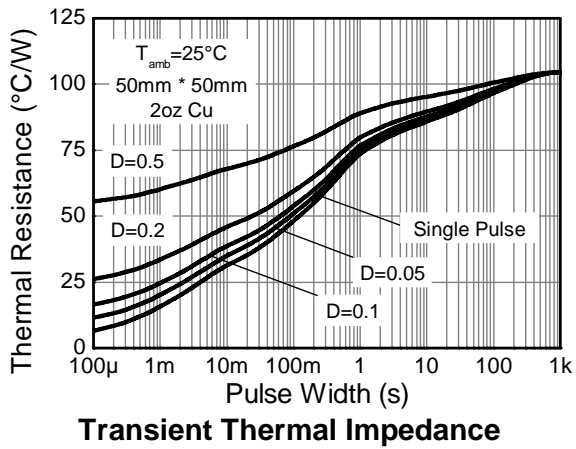
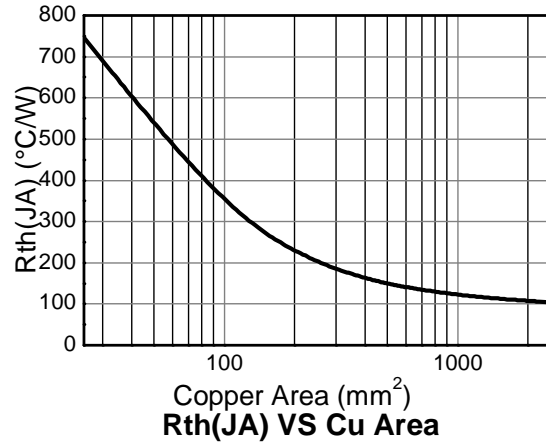
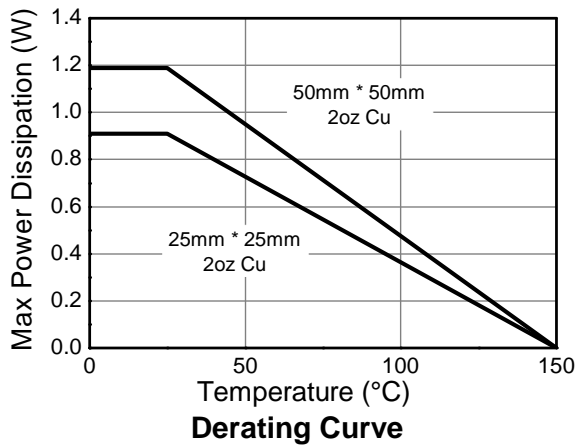

Typical Electrical Characteristics (continued) (@ $T_A = +25^\circ\text{C}$, unless otherwise specified.)

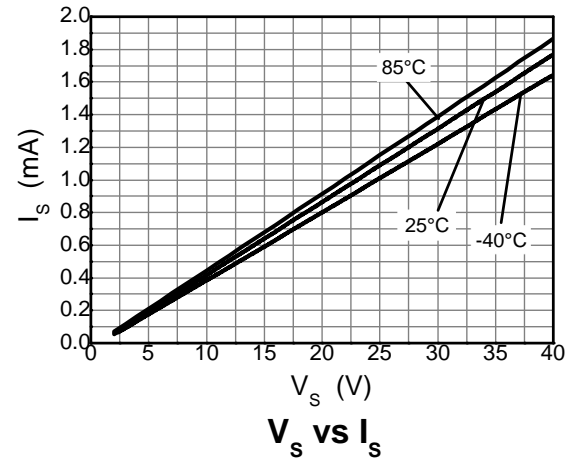
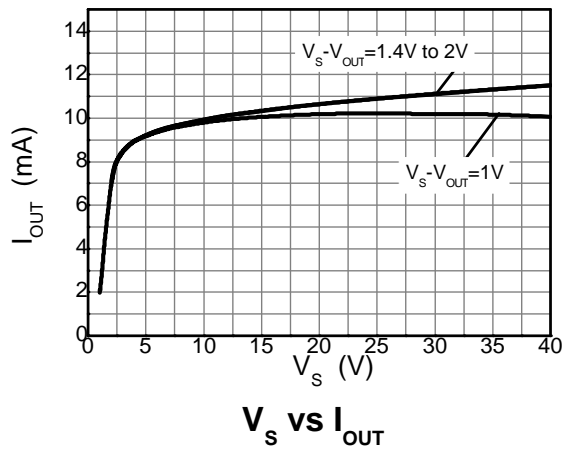
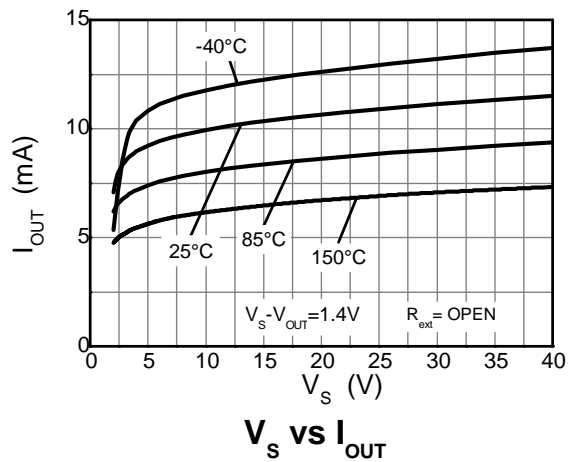
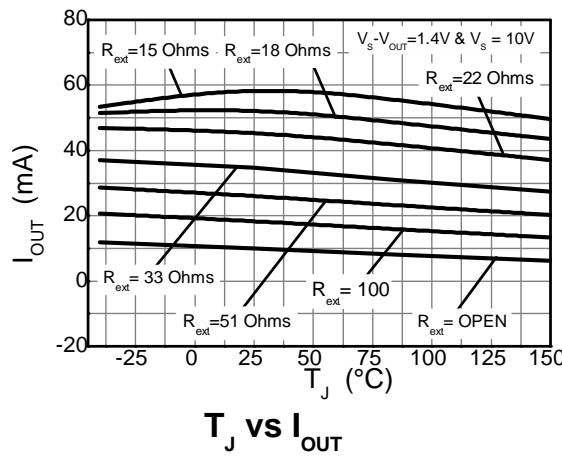
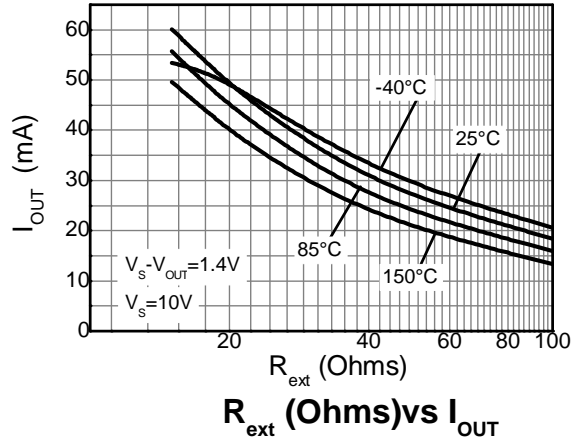
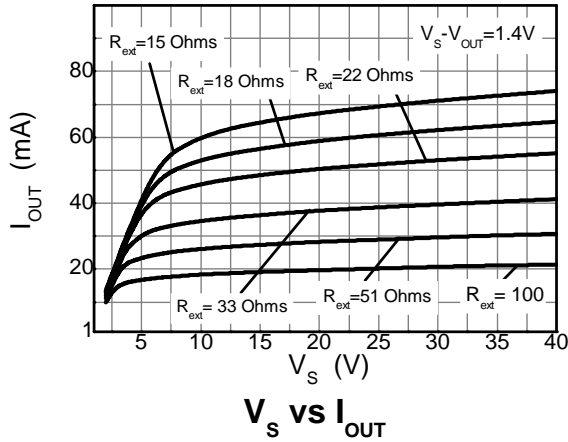

Package Outline Dimensions

Please see <http://www.diodes.com/package-outlines.html> for the latest version.

SOT26 (SC74R)

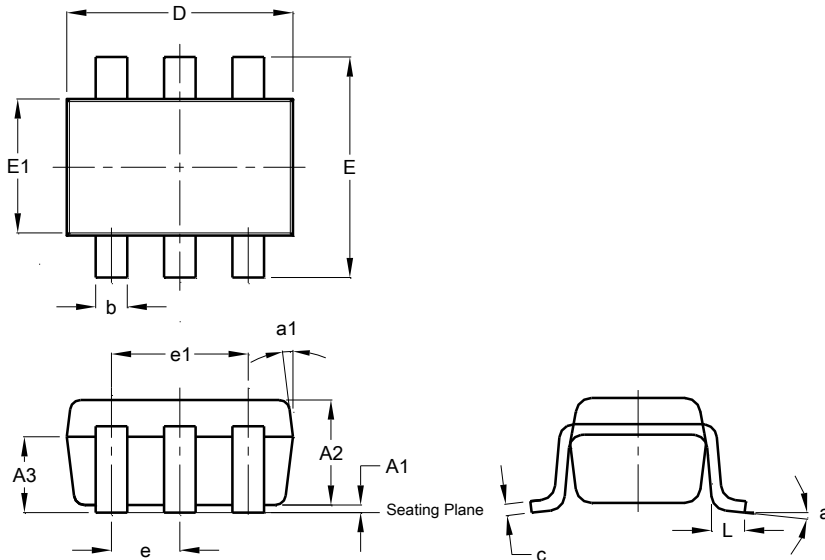

SOT26 (SC74R)			
Dim	Min	Max	Typ
A1	0.013	0.10	0.05
A2	1.00	1.30	1.10
A3	0.70	0.80	0.75
b	0.35	0.50	0.38
c	0.10	0.20	0.15
D	2.90	3.10	3.00
e	-	-	0.95
e1	-	-	1.90
E	2.70	3.00	2.80
E1	1.50	1.70	1.60
L	0.35	0.55	0.40
a	-	-	8°
a1	-	-	7°
All Dimensions in mm			

Suggested Pad Layout

Please see <http://www.diodes.com/package-outlines.html> for the latest version.

SOT26 (SC74R)

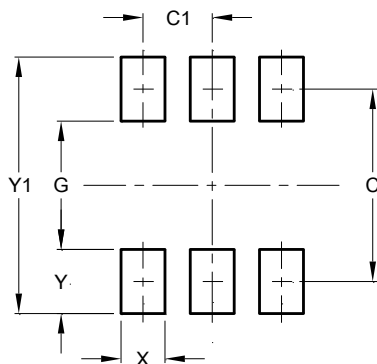

Dimensions	Value (in mm)
C	2.40
C1	0.95
G	1.60
X	0.55
Y	0.80
Y1	3.20

IMPORTANT NOTICE

DIODES INCORPORATED MAKES NO WARRANTY OF ANY KIND, EXPRESS OR IMPLIED, WITH REGARDS TO THIS DOCUMENT, INCLUDING, BUT NOT LIMITED TO, THE IMPLIED WARRANTIES OF MERCHANTABILITY AND FITNESS FOR A PARTICULAR PURPOSE (AND THEIR EQUIVALENTS UNDER THE LAWS OF ANY JURISDICTION).

Diodes Incorporated and its subsidiaries reserve the right to make modifications, enhancements, improvements, corrections or other changes without further notice to this document and any product described herein. Diodes Incorporated does not assume any liability arising out of the application or use of this document or any product described herein; neither does Diodes Incorporated convey any license under its patent or trademark rights, nor the rights of others. Any Customer or user of this document or products described herein in such applications shall assume all risks of such use and will agree to hold Diodes Incorporated and all the companies whose products are represented on Diodes Incorporated website, harmless against all damages.

Diodes Incorporated does not warrant or accept any liability whatsoever in respect of any products purchased through unauthorized sales channel. Should Customers purchase or use Diodes Incorporated products for any unintended or unauthorized application, Customers shall indemnify and hold Diodes Incorporated and its representatives harmless against all claims, damages, expenses, and attorney fees arising out of, directly or indirectly, any claim of personal injury or death associated with such unintended or unauthorized application.

Products described herein may be covered by one or more United States, international or foreign patents pending. Product names and markings noted herein may also be covered by one or more United States, international or foreign trademarks.

This document is written in English but may be translated into multiple languages for reference. Only the English version of this document is the final and determinative format released by Diodes Incorporated.

LIFE SUPPORT

Diodes Incorporated products are specifically not authorized for use as critical components in life support devices or systems without the express written approval of the Chief Executive Officer of Diodes Incorporated. As used herein:

A. Life support devices or systems are devices or systems which:

1. are intended to implant into the body, or
2. support or sustain life and whose failure to perform when properly used in accordance with instructions for use provided in the labeling can be reasonably expected to result in significant injury to the user.

B. A critical component is any component in a life support device or system whose failure to perform can be reasonably expected to cause the failure of the life support device or to affect its safety or effectiveness.

Customers represent that they have all necessary expertise in the safety and regulatory ramifications of their life support devices or systems, and acknowledge and agree that they are solely responsible for all legal, regulatory and safety-related requirements concerning their products and any use of Diodes Incorporated products in such safety-critical, life support devices or systems, notwithstanding any devices- or systems-related information or support that may be provided by Diodes Incorporated. Further, Customers must fully indemnify Diodes Incorporated and its representatives against any damages arising out of the use of Diodes Incorporated products in such safety-critical, life support devices or systems.

Copyright © 2016, Diodes Incorporated

www.diodes.com

Компания «Океан Электроники» предлагает заключение долгосрочных отношений при поставках импортных электронных компонентов на взаимовыгодных условиях!

Наши преимущества:

- Поставка оригинальных импортных электронных компонентов напрямую с производств Америки, Европы и Азии, а так же с крупнейших складов мира;
- Широкая линейка поставок активных и пассивных импортных электронных компонентов (более 30 млн. наименований);
- Поставка сложных, дефицитных, либо снятых с производства позиций;
- Оперативные сроки поставки под заказ (от 5 рабочих дней);
- Экспресс доставка в любую точку России;
- Помощь Конструкторского Отдела и консультации квалифицированных инженеров;
- Техническая поддержка проекта, помощь в подборе аналогов, поставка прототипов;
- Поставка электронных компонентов под контролем ВП;
- Система менеджмента качества сертифицирована по Международному стандарту ISO 9001;
- При необходимости вся продукция военного и аэрокосмического назначения проходит испытания и сертификацию в лаборатории (по согласованию с заказчиком);
- Поставка специализированных компонентов военного и аэрокосмического уровня качества (Xilinx, Altera, Analog Devices, Intersil, Interpoint, Microsemi, Actel, Aeroflex, Peregrine, VPT, Syfer, Eurofarad, Texas Instruments, MS Kennedy, Miteq, Cobham, E2V, MA-COM, Hittite, Mini-Circuits, General Dynamics и др.);

Компания «Океан Электроники» является официальным дистрибьютором и эксклюзивным представителем в России одного из крупнейших производителей разъемов военного и аэрокосмического назначения «JONHON», а так же официальным дистрибьютором и эксклюзивным представителем в России производителя высокотехнологичных и надежных решений для передачи СВЧ сигналов «FORSTAR».



JONHON

«JONHON» (основан в 1970 г.)

Разъемы специального, военного и аэрокосмического назначения:

(Применяются в военной, авиационной, аэрокосмической, морской, железнодорожной, горно- и нефтедобывающей отраслях промышленности)

«FORSTAR» (основан в 1998 г.)

ВЧ соединители, коаксиальные кабели, кабельные сборки и микроволновые компоненты:

(Применяются в телекоммуникациях гражданского и специального назначения, в средствах связи, РЛС, а так же военной, авиационной и аэрокосмической отраслях промышленности).



Телефон: 8 (812) 309-75-97 (многоканальный)

Факс: 8 (812) 320-03-32

Электронная почта: ocean@oceanchips.ru

Web: <http://oceanchips.ru/>

Адрес: 198099, г. Санкт-Петербург, ул. Калинина, д. 2, корп. 4, лит. А