



TISP4070J3BJ THRU TISP4395J3BJ

BIDIRECTIONAL THYRISTOR OVERVOLTAGE PROTECTORS

TISP4xxxJ3BJ Overvoltage Protector Series

Ion-Implanted Breakdown Region  
- Precise and Stable Voltage

Low Voltage Overshoot Under Surge

Designed for Transformer Center Tap (Ground Return)  
Overvoltage Protection

- Enables GR-1089-CORE Compliance
- High Holding Current Allows Protection of Data Lines with d.c Power Feed

Can be Used to Protect Rugged Modems Designed for Exposed Applications Exceeding TIA-968-A

Device Name	V <sub>DRM</sub> V	V <sub>(BO)</sub> V
TISP4070J3BJ	58	70
TISP4080J3BJ	65	80
TISP4095J3BJ	75	95
TISP4115J3BJ	90	115
TISP4125J3BJ	100	125
TISP4145J3BJ	120	145
TISP4165J3BJ	135	165
TISP4180J3BJ	145	180
TISP4200J3BJ	155	200
TISP4219J3BJ	180	219
TISP4250J3BJ	190	250
TISP4290J3BJ	220	290
TISP4350J3BJ	275	350
TISP4395H3BJ	320	395

SMB Package (Top View)

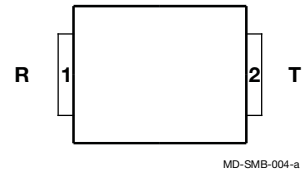

Device Symbol



Rated for International Surge Wave Shapes

Wave Shape	Standard	I <sub>PPSM</sub> A
2/10	GR-1089-CORE	1000
8/20	IEC 61000-4-5	800
10/160	TIA-968-A	400
10/700	ITU-T K.20/21/45	350
10/560	TIA-968-A	250
10/1000	GR-1089-CORE	200

.....UL Recognized Component

Description

The range of TISP4xxxJ3BJ devices is designed to limit overvoltages on telecom lines. The TISP4xxxJ3BJ is primarily designed to address GR-1089-CORE compliance on data transmission lines with d.c. power feeding. When overvoltage protection is applied to transformer coupled lines from the transformer center tap to ground, the total ground return current can be 200 A, 10/1000 and 1000 A, 2/10. The high 150 mA holding current is set above common d.c. feed system levels to allow the TISP4xxxJ3BJ to reset following a disturbance.

These devices allow signal voltages, without clipping, up to the maximum off-state voltage value, V<sub>DRM</sub>, see Figure 1. Voltages above V<sub>DRM</sub> are limited and will not exceed the breakover voltage, V<sub>(BO)</sub>, level. If sufficient current flows due to the overvoltage, the device switches into a low voltage on-state condition, which diverts the current from the overvoltage through the device. When the diverted current falls below the holding current, I<sub>H</sub>, level the devices switches off and restores normal system operation.

How to Order

Device	Package	Carrier	Order As	Marking Code	Standard Quantity
TISP4xxxJ3BJ	SMB	Embossed Tape Reeled	TISP4xxxJ3BJR-S	4xxxJ3	3000

Insert xxx corresponding to device name.

\*RoHS Directive 2002/95/EC Jan 27 2003 including Annex  
JULY 2003 – REVISED MAY 2007  
Specifications are subject to change without notice.  
Customers should verify actual device performance in their specific applications.

# TISP4xxxJ3BJ Overvoltage Protector Series

**BOURNS®**

## Absolute Maximum Ratings, $T_A = 25\text{ }^\circ\text{C}$ (Unless Otherwise Noted)

Rating	Symbol	Value	Unit
Repetitive peak off-state voltage	'4070J3BJ	±58	V
	'4080J3BJ	±65	
	'4095J3BJ	±75	
	'4115J3BJ	±90	
	'4125J3BJ	±100	
	'4145J3BJ	±120	
	'4165J3BJ	±135	
	'4180J3BJ	±145	
	'4200J3BJ	±155	
	'4219J3BJ	±180	
	'4250J3BJ	±190	
	'4290J3BJ	±220	
	'4350J3BJ	±275	
	'4395J3BJ	±320	
Non-repetitive peak impulse current (see Notes 1 and 2) 2/10 $\mu\text{s}$ (GR-1089-CORE, 2/10 $\mu\text{s}$ voltage wave shape) 8/20 $\mu\text{s}$ (IEC 61000-4-5, combination wave generator, 1.2/50 $\mu\text{s}$ voltage wave shape) 10/160 $\mu\text{s}$ (TIA-968-A, 10/160 $\mu\text{s}$ voltage wave shape) 4/250 $\mu\text{s}$ (ITU-T K.20/21, 10/700 $\mu\text{s}$ voltage waveshape, simultaneous) 5/310 $\mu\text{s}$ (ITU-T K.20/21, 10/700 $\mu\text{s}$ voltage wave shape, single) 5/320 $\mu\text{s}$ (TIA-968-A, 9/720 $\mu\text{s}$ voltage waveshape, single) 10/560 $\mu\text{s}$ (TIA-968-A, 10/560 $\mu\text{s}$ voltage wave shape) 10/1000 $\mu\text{s}$ (GR-1089-CORE, 10/1000 $\mu\text{s}$ voltage wave shape)	$I_{PPSM}$	±1000 ±800 ±400 ±370 ±350 ±350 ±250 ±200	A
Non-repetitive peak on-state current (see Notes 1 and 2) 20 ms, 50 Hz (full sine wave)	$I_{TSM}$	50	A
Initial rate of rise of on-state current. Linear current ramp. Maximum ramp value < 50 A	$di_T/dt$	800	A/ $\mu\text{s}$
Junction temperature	$T_J$	-40 to +150	$^\circ\text{C}$
Storage temperature range	$T_{stg}$	-65 to +150	$^\circ\text{C}$

NOTES: 1. Initially the device must be in thermal equilibrium with  $T_J = 25\text{ }^\circ\text{C}$ .

2. These non-repetitive rated currents are peak values of either polarity. The surge may be repeated after the device returns to its initial conditions.

## Electrical Characteristics, $T_A = 25\text{ }^\circ\text{C}$ (Unless Otherwise Noted)

Parameter	Test Conditions	Min	Typ	Max	Unit
$I_{DRM}$ Repetitive peak off-state current	$V_D = V_{DRM}$ $T_A = 25\text{ }^\circ\text{C}$ $T_A = 85\text{ }^\circ\text{C}$			±5 ±10	$\mu\text{A}$
$V_{(BO)}$ AC Breakover voltage	$dv/dt = \pm 250\text{ V/ms}$ , $R_{SOURCE} = 300\ \Omega$			±70 ±80 ±95 ±115 ±125 ±145 ±165 ±180 ±200 ±219 ±250 ±290 ±350 ±395	V

JULY 2003 – REVISED MAY 2007

Specifications are subject to change without notice.  
Customers should verify actual device performance in their specific applications.

# TISP4xxxJ3BJ Overvoltage Protector Series

**BOURNS®**

## Electrical Characteristics, $T_A = 25\text{ °C}$ (Unless Otherwise Noted) (Continued)

Parameter	Test Conditions	Min	Typ	Max	Unit			
$V_{(BO)}$ Ramp breakover voltage	dv/dt $\leq$ $\pm 1000\text{ V}/\mu\text{s}$ , Linear voltage ramp, Maximum ramp value = $\pm 500\text{ V}$ di/dt = $\pm 20\text{ A}/\mu\text{s}$ , Linear current ramp, Maximum ramp value = $\pm 10\text{ A}$			'4070J3BJ	$\pm 77$			
				'4080J3BJ	$\pm 88$			
				'4095J3BJ	$\pm 104$			
				'4115J3BJ	$\pm 125$			
				'4125J3BJ	$\pm 135$			
				'4145J3BJ	$\pm 156$			
				'4165J3BJ	$\pm 177$			
				'4180J3BJ	$\pm 192$			
				'4200J3BJ	$\pm 212$			
				'4219J3BJ	$\pm 231$			
				'4250J3BJ	$\pm 263$			
				'4290J3BJ	$\pm 303$			
'4350J3BJ	$\pm 364$							
'4395J3BJ	$\pm 409$							
$I_{(BO)}$ Breakover current	dv/dt = $\pm 250\text{ V}/\text{ms}$ , $R_{SOURCE} = 300\ \Omega$			'4070J3BJ thru '4115J3BJ '4125J3BJ thru '4219J3BJ '4250J3BJ thru '4395J3BJ	$\pm 900$ $\pm 800$ $\pm 600$	mA		
$I_H$ Holding current	$I_T = \pm 5\text{ A}$ , di/dt = $\pm 30\text{ mA}/\text{ms}$	$\pm 150$			$\pm 600$	mA		
dv/dt Critical rate of rise of off-state voltage	Linear voltage ramp Maximum ramp value $< 0.85V_{DRM}$	$\pm 5$				kV/ $\mu\text{s}$		
$I_D$ Off-state current	$V_D = \pm 50\text{ V}$				$\pm 10$	$\mu\text{A}$		
$C_O$ Off-state capacitance	f = 1 MHz, $V_d = 1\text{ V rms}$ , $V_D = 0$			'4070J3BJ thru '4115J3BJ	195	235	pF	
				'4125J3BJ thru '4219J3BJ	120	145		
				'4250J3BJ thru '4395J3BJ	105	125		
	f = 1 MHz, $V_d = 1\text{ V rms}$ , $V_D = -1\text{ V}$				'4070J3BJ thru '4115J3BJ	180		215
					'4125J3BJ thru '4219J3BJ	110		132
					'4250J3BJ thru '4395J3BJ	95		115
	f = 1 MHz, $V_d = 1\text{ V rms}$ , $V_D = -2\text{ V}$				'4070J3BJ thru '4115J3BJ	165		200
					'4125J3BJ thru '4219J3BJ	100		120
					'4250J3BJ thru '4395J3BJ	90		105
	f = 1 MHz, $V_d = 1\text{ V rms}$ , $V_D = -50\text{ V}$				'4070J3BJ thru '4115J3BJ	85		100
					'4125J3BJ thru '4219J3BJ	50		60
					'4250J3BJ thru '4395J3BJ	42		50
f = 1 MHz, $V_d = 1\text{ V rms}$ , $V_D = -100\text{ V}$ (see Note 3)				'4125J3BJ thru '4219J3BJ	40	50		
				'4250J3BJ thru '4395J3BJ	35	40		

NOTE: 3. To avoid possible clipping, the TISP4125J3BJ is tested with  $V_D = -98\text{ V}$ .

## Thermal Characteristics

Parameter	Test Conditions	Min	Typ	Max	Unit
$R_{\theta JA}$ Junction to ambient thermal resistance	EIA/JESD51-3 PCB, $I_T = I_{TSM(1000)}$ (see Note 4)			90	$^{\circ}\text{C}/\text{W}$

NOTE: 4. EIA/JESD51-2 environment and PCB has standard footprint dimensions connected with 5 A rated printed wiring track widths.

## Parameter Measurement Information



PM-TISP4xxx-001-a

Figure 1. Voltage-Current Characteristic for T and R Terminals  
All Measurements are Referenced to the R Terminal

## Typical Characteristics

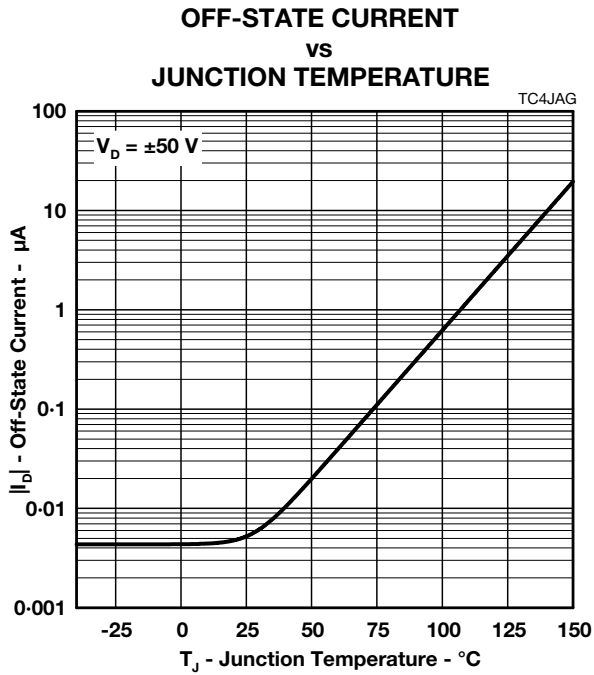

Figure 2.

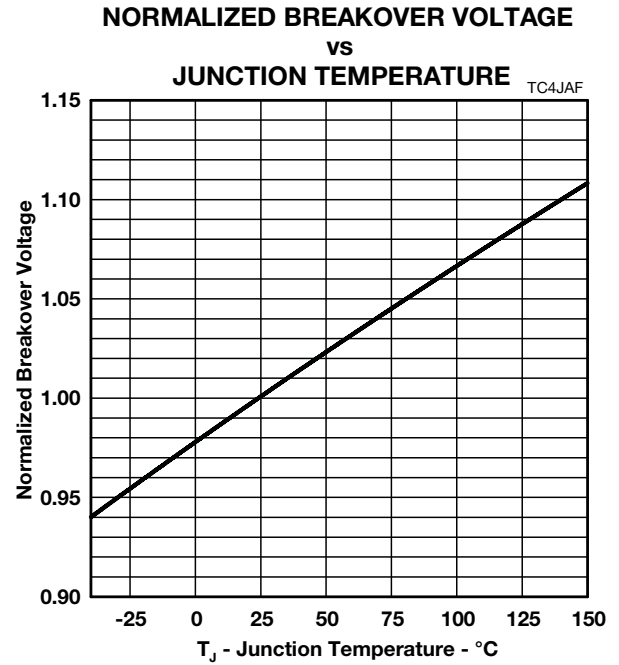

Figure 3.

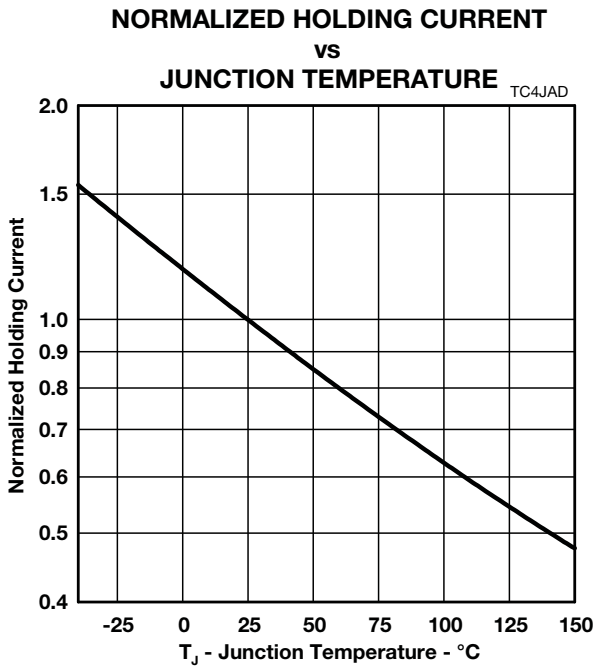

Figure 4.

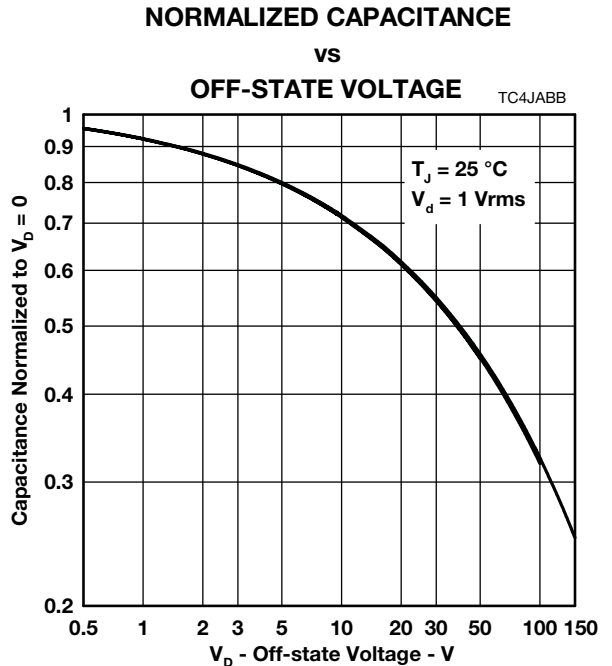

Figure 5.

## Rating and Thermal Information

### NON-REPETITIVE PEAK ON-STATE CURRENT vs CURRENT DURATION



Figure 6.

### $V_{DRM}$ DERATING FACTOR vs

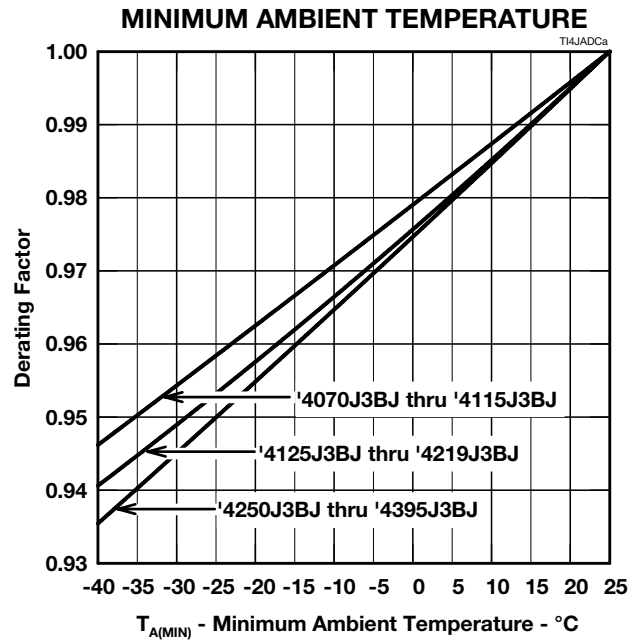

Figure 7.

# TISP4xxxJ3BJ Overvoltage Protector Series

**BOURNS®**

## Applications Information



Figure 8. Typical Application Circuit

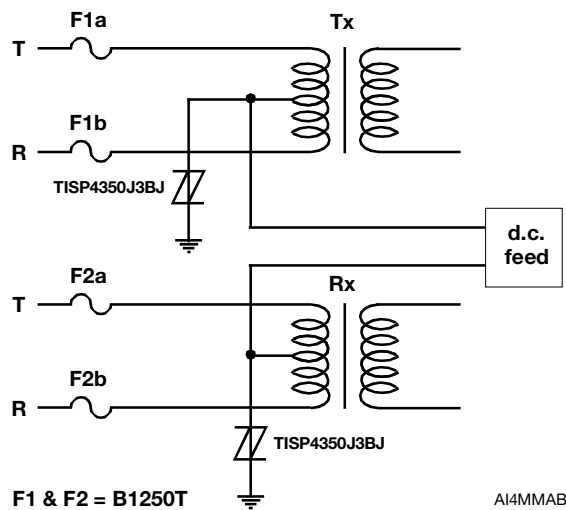

Figure 9. Typical Application Circuit

### **Bourns Sales Offices**

<u>Region</u>	<u>Phone</u>	<u>Fax</u>
The Americas:	+1-951-781-5500	+1-951-781-5700
Europe:	+41-41-7685555	+41-41-7685510
Asia-Pacific:	+886-2-25624117	+886-2-25624116

### **Technical Assistance**

<u>Region</u>	<u>Phone</u>	<u>Fax</u>
The Americas:	+1-951-781-5500	+1-951-781-5700
Europe:	+41-41-7685555	+41-41-7685510
Asia-Pacific:	+886-2-25624117	+886-2-25624116

### **[www.bourns.com](http://www.bourns.com)**

Bourns® products are available through an extensive network of manufacturer's representatives, agents and distributors. To obtain technical applications assistance, a quotation, or to place an order, contact a Bourns representative in your area.



*Reliable Electronic Solutions*

"TISP" is a trademark of Bourns, Ltd., a Bourns Company, and is Registered in U.S. Patent and Trademark Office.  
"Bourns" is a registered trademark of Bourns, Inc. in the U.S. and other countries.

JULY 2003 – REVISED MAY 2007  
Specifications are subject to change without notice.  
Customers should verify actual device performance in their specific applications.



Компания «Океан Электроники» предлагает заключение долгосрочных отношений при поставках импортных электронных компонентов на взаимовыгодных условиях!

Наши преимущества:

- Поставка оригинальных импортных электронных компонентов напрямую с производств Америки, Европы и Азии, а так же с крупнейших складов мира;
- Широкая линейка поставок активных и пассивных импортных электронных компонентов (более 30 млн. наименований);
- Поставка сложных, дефицитных, либо снятых с производства позиций;
- Оперативные сроки поставки под заказ (от 5 рабочих дней);
- Экспресс доставка в любую точку России;
- Помощь Конструкторского Отдела и консультации квалифицированных инженеров;
- Техническая поддержка проекта, помощь в подборе аналогов, поставка прототипов;
- Поставка электронных компонентов под контролем ВП;
- Система менеджмента качества сертифицирована по Международному стандарту ISO 9001;
- При необходимости вся продукция военного и аэрокосмического назначения проходит испытания и сертификацию в лаборатории (по согласованию с заказчиком);
- Поставка специализированных компонентов военного и аэрокосмического уровня качества (Xilinx, Altera, Analog Devices, Intersil, Interpoint, Microsemi, Actel, Aeroflex, Peregrine, VPT, Syfer, Eurofarad, Texas Instruments, MS Kennedy, Miteq, Cobham, E2V, MA-COM, Hittite, Mini-Circuits, General Dynamics и др.);

Компания «Океан Электроники» является официальным дистрибьютором и эксклюзивным представителем в России одного из крупнейших производителей разъемов военного и аэрокосмического назначения «JONHON», а так же официальным дистрибьютором и эксклюзивным представителем в России производителя высокотехнологичных и надежных решений для передачи СВЧ сигналов «FORSTAR».



## JONHON

«JONHON» (основан в 1970 г.)

Разъемы специального, военного и аэрокосмического назначения:

(Применяются в военной, авиационной, аэрокосмической, морской, железнодорожной, горно- и нефтедобывающей отраслях промышленности)

«FORSTAR» (основан в 1998 г.)

ВЧ соединители, коаксиальные кабели, кабельные сборки и микроволновые компоненты:

(Применяются в телекоммуникациях гражданского и специального назначения, в средствах связи, РЛС, а так же военной, авиационной и аэрокосмической отраслях промышленности).



Телефон: 8 (812) 309-75-97 (многоканальный)

Факс: 8 (812) 320-03-32

Электронная почта: [ocean@oceanchips.ru](mailto:ocean@oceanchips.ru)

Web: <http://oceanchips.ru/>

Адрес: 198099, г. Санкт-Петербург, ул. Калинина, д. 2, корп. 4, лит. А