

# DC Brush Motor Drivers (7V Max)

## BD621xxx Series

### General Description

These H-bridge drivers are full bridge drivers for brush motor applications. Each IC can operate at a power supply voltage range of 3.0V to 5.5V, with output currents of up to 2A. MOS transistors in the output stage allow PWM speed control. The integrated VREF voltage control function allows direct replacement of discontinued motor driver ICs. These highly efficient H-bridge driver ICs facilitate low-power consumption design.

### Features

- Built-in one channel configuration
- VREF Voltage Setting Pin Enables PWM Duty Control
- Cross-Conduction Prevention Circuit
- Four Protection Circuits Provided: OCP, OVP, TSD and UVLO

### Applications

VTR; CD/DVD players; audio-visual equipment; optical disc drives; PC peripherals; OA equipments

### Key Specifications

- Operating Supply Voltage: 7V(Max)
- Maximum Output Current: 0.5A / 1.0A / 2.0A
- Output ON-Resistance: 1.0Ω / 1.0Ω / 0.5Ω
- PWM Input Frequency Range: 20kHz to 100kHz
- Standby Current: 0μA (Typ)
- Operating Temperature Range: -40°C to +85°C

### Packages

- |        |                              |
|--------|------------------------------|
|        | W(Typ) x D(Typ) x H(Max)     |
| SOP8   | 5.00mm x 6.20mm x 1.71mm     |
| HSOP25 | 13.60mm x 7.80mm x 2.11mm    |
| HRP7   | 9.395mm x 10.540mm x 2.005mm |



### Ordering Information

B D 6 2 1 x x x x	-	x x
Part Number	Package	Packaging and forming specification
	F : SOP8	E2: Embossed tape and reel (SOP8/HSOP25)
	FP : HSOP25	TR: Embossed tape and reel (HRP7)
	HFP : HRP7	

### Lineup

Rating voltage (Max)	Channels	Maximum output current (Max)	Package		Orderable Part Number
7V	1ch	0.5A	HRP7	Reel of 2000	BD6210HFP-TR
			SOP8	Reel of 2500	BD6210F-E2
		1.0A	HRP7	Reel of 2000	BD6211HFP-TR
			SOP8	Reel of 2500	BD6211F-E2
		2.0A	HRP7	Reel of 2000	BD6212HFP-TR
			HSOP25	Reel of 2000	BD6212FP-E2

○Product structure : Silicon monolithic integrated circuit ○This product has no designed protection against radioactive rays.

Block Diagrams / Pin Configurations / Pin Descriptions

BD6210F / BD6211F



Figure 1. BD6210F / BD6211F



Figure 2. SOP8 (TOP VIEW)

Table 1 BD6210F/BD6211F

Pin	Name	Function
1	OUT1	Driver output
2	VCC	Power supply
3	VCC	Power supply
4	FIN	Control input (forward)
5	RIN	Control input (reverse)
6	VREF	Duty setting pin
7	OUT2	Driver output
8	GND	Ground

(Note) Use all VCC pin by the same voltage.

BD6210HFP / BD6211HFP / BD6212HFP



Figure 3. BD6210HFP / BD6211HFP / BD6212HFP

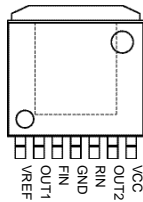

Figure 4. HRP7 (TOP VIEW)

Table 2 BD6210HFP/BD6211HFP/BD6212HFP

Pin	Name	Function
1	VREF	Duty setting pin
2	OUT1	Driver output
3	FIN	Control input (forward)
4	GND	Ground
5	RIN	Control input (reverse)
6	OUT2	Driver output
7	VCC	Power supply
FIN	GND	Ground

BD6212FP



Figure 5. BD6212FP



Figure 6. HSOP25 (TOP VIEW)

Table 3 BD6212FP

Pin	Name	Function
1,2	OUT1	Driver output
6	GND	Small signal ground
7,8	RNF	Power stage ground
12,13	OUT2	Driver output
17	VREF	Duty setting pin
19	RIN	Control input (reverse)
20	FIN	Control input (forward)
21	VCC	Power supply
22,23	VCC	Power supply
FIN	GND	Ground

(Note) All pins not described above are NC pins.  
Note: Use all VCC pin by the same voltage.

**Absolute Maximum Ratings (Ta=25°C, All voltages are with respect to ground)**

Parameter	Symbol	Rating	Unit
Supply Voltage	V <sub>CC</sub>	7	V
Output Current	I <sub>OMAX</sub>	0.5 (Note 1) / 1.0 (Note 2) / 2.0 (Note 3)	A
All Other Input Pins	V <sub>IN</sub>	-0.3 to V <sub>CC</sub>	V
Operating Temperature	T <sub>opr</sub>	-40 to +85	°C
Storage Temperature	T <sub>stg</sub>	-55 to +150	°C
Power Dissipation	P <sub>d</sub>	0.68 (Note 4) / 1.6 (Note 5) / 1.45 (Note 6)	W
Junction Temperature	T <sub>jmax</sub>	150	°C

(Note 1) BD6210. Do not exceed Pd or ASO.

(Note 2) BD6211. Do not exceed Pd or ASO.

(Note 3) BD6212. Do not exceed Pd or ASO.

(Note 4) SOP8 package. Mounted on a 70mm x 70mm x 1.6mm glass-epoxy board. Derate by 5.5mW/°C for Ta above 25°C.

(Note 5) HRP7 package. Mounted on a 70mm x 70mm x 1.6mm glass-epoxy board. Derate by 12.8mW/°C for Ta above 25°C.

(Note 6) HSOP25 package. Mounted on a 70mm x 70mm x 1.6mm glass-epoxy board. Derate by 11.6mW/°C for Ta above 25°C.

**Caution:** Operating the IC over the absolute maximum ratings may damage the IC. The damage can either be a short circuit between pins or an open circuit between pins and the internal circuitry. Therefore, it is important to consider circuit protection measures, such as adding a fuse, in case the IC is operated over the absolute maximum ratings.**Recommended Operating Conditions (Ta=25°C)**

Parameter	Symbol	Rating	Unit
Supply Voltage	V <sub>CC</sub>	3.0 to 5.5	V
VREF Voltage	V <sub>REF</sub>	1.5 to 5.5	V

**Electrical Characteristics (Unless otherwise specified, Ta=25°C and V<sub>CC</sub>=V<sub>REF</sub>=5V)**

Parameter	Symbol	Limit			Limit	Conditions
		Min	Typ	Max		
Supply Current (1ch)	I <sub>CC</sub>	0.4	0.7	1.5	mA	Forward / Reverse / Brake
Stand-by Current	I <sub>STBY</sub>	-	0	10	μA	Stand-by
Input High Voltage	V <sub>IH</sub>	2.0	-	-	V	
Input Low Voltage	V <sub>IL</sub>	-	-	0.8	V	
Input Bias Current	I <sub>IH</sub>	30	50	100	μA	V <sub>IN</sub> =5.0V
Output ON-Resistance (Note 7)	R <sub>ON</sub>	0.5	1.0	1.5	Ω	I <sub>OUT</sub> =0.25A, vertically total
Output ON-Resistance (Note 8)	R <sub>ON</sub>	0.5	1.0	1.5	Ω	I <sub>OUT</sub> =0.5A, vertically total
Output ON-Resistance (Note 9)	R <sub>ON</sub>	0.2	0.5	1.0	Ω	I <sub>OUT</sub> =1.0A, vertically total
VREF Bias Current	I <sub>VREF</sub>	-10	0	+10	μA	V <sub>REF</sub> =V <sub>CC</sub>
Carrier Frequency	f <sub>PWM</sub>	20	25	35	kHz	V <sub>REF</sub> =3.75V
Input Frequency Range	f <sub>MAX</sub>	20	-	100	kHz	FIN / RIN

(Note 7) BD6210

(Note 8) BD6211

(Note 9) BD6212

Typical Performance Curves (Reference Data)



Figure 7. Supply Current vs Supply Voltage (1ch)



Figure 8. Internal Logic vs Input Voltage (Input Threshold Voltage)

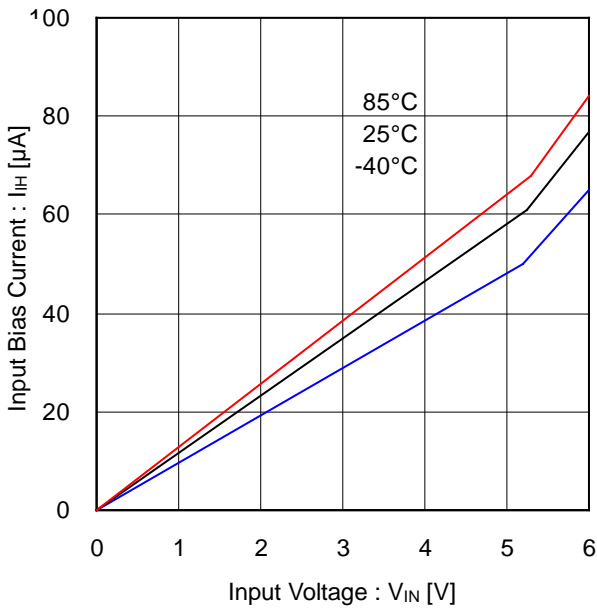

Figure 9. Input Bias Current vs Input Voltage



Figure 10. VREF Input Bias Current vs Input Voltage

Typical Performance Curves (Reference Data) – continued



Figure 11. Switching Duty vs Input Voltage (V<sub>CC</sub>=5V)



Figure 12. Oscillation Frequency vs Supply Voltage (V<sub>CC</sub> – Carrier Frequency)



Figure 13. Internal Signal vs Supply Voltage (Under Voltage Lock Out)



Figure 14. Internal Signal vs Supply Voltage (Over Voltage Protection)

Typical Performance Curves (Reference Data) – continued



Figure 15. Internal Logic vs Junction Temperature (Thermal Shutdown)



Figure 16. Internal Logic vs Load Current (Over-Current Protection, H side)

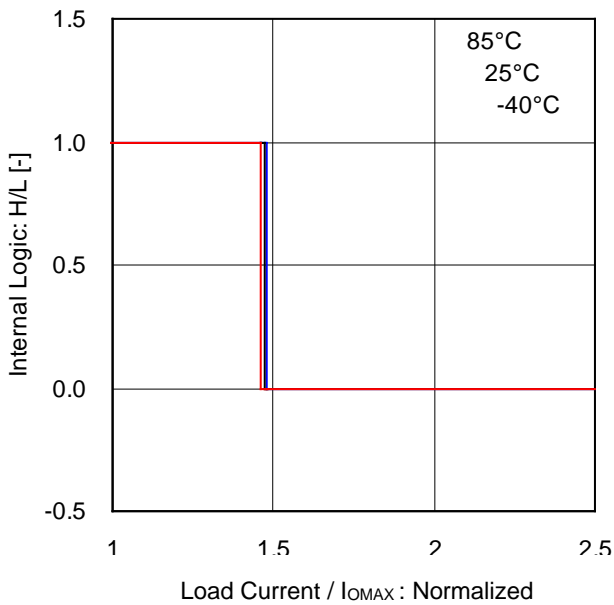

Figure 17. Internal Logic vs Load Current (Over-Current Protection, L side)

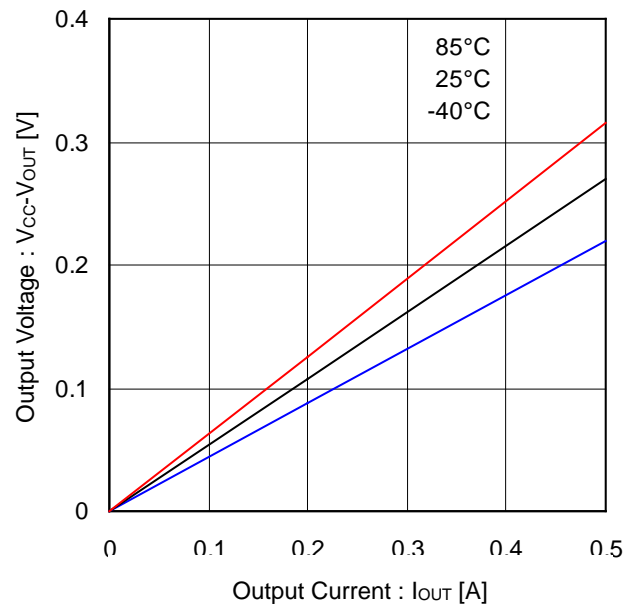

Figure 18. Output High Voltage vs Output Current (BD6210)

Typical Performance Curves (Reference Data) – continued



Figure 19. Output High Voltage vs Output Current (BD6211)

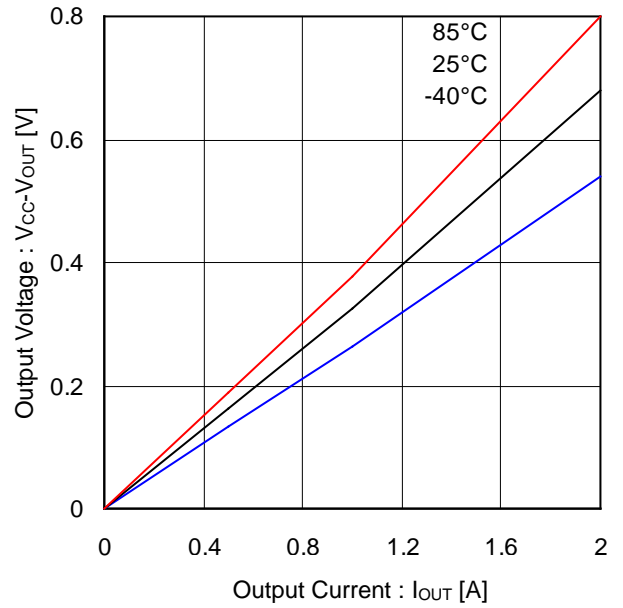

Figure 20. Output High Voltage vs Output Current (BD6212)

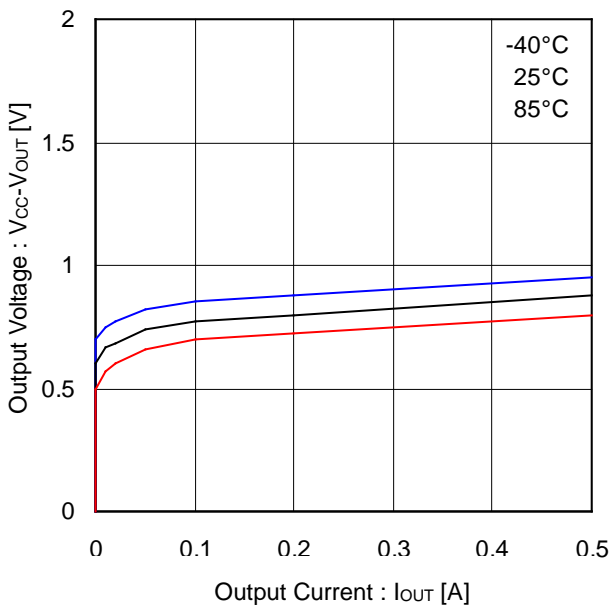

Figure 21. Output Voltage vs Output Current (High Side Body Diode, BD6210)

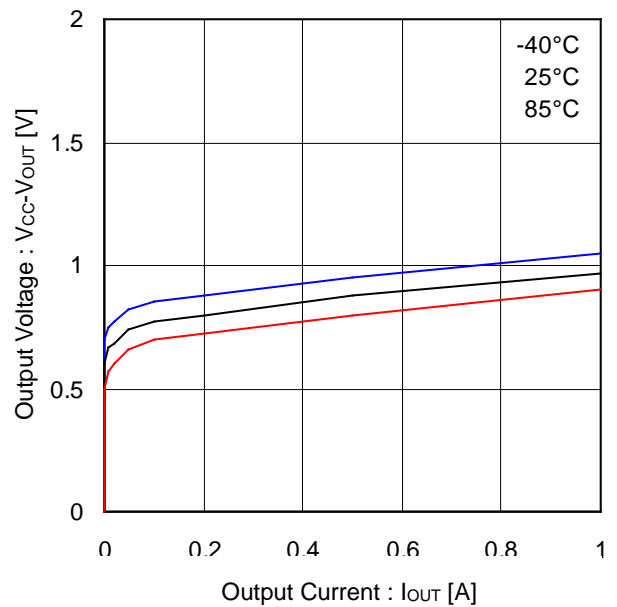

Figure 22. Output Voltage vs Output Current (High Side Body Diode, BD6211)

Typical Performance Curves (Reference Data) – continued

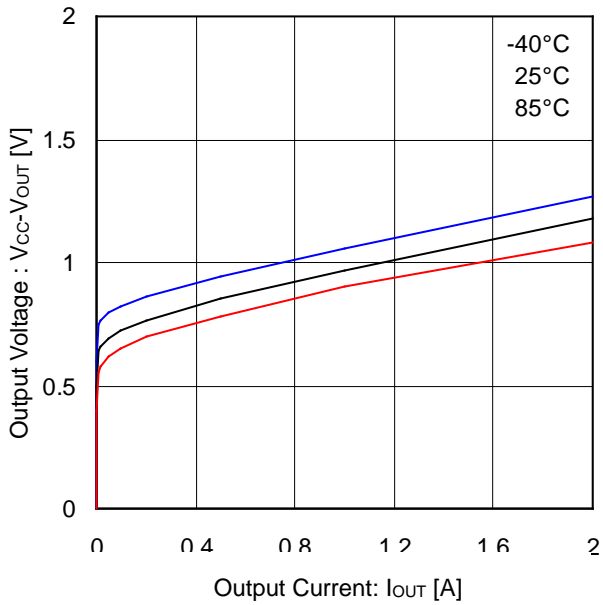

Figure 23. Output Voltage vs Output Current (High Side Body Diode, BD6212)



Figure 24. Output Low Voltage vs Output Current (BD6210)

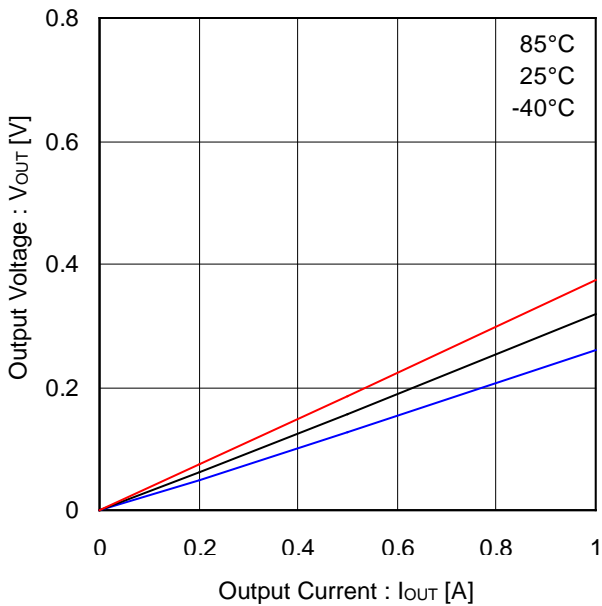

Figure 25. Output Low Voltage vs Output Current (BD6211)



Figure 26. Output Low Voltage vs Output Current (BD6212)



Typical Performance Curves (Reference Data) – continued

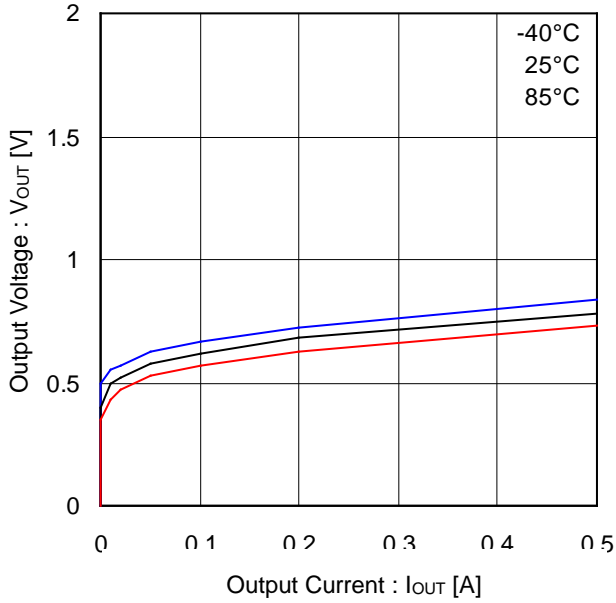

Figure 27. Output Voltage vs Output Current (Low Side Body Diode, BD6210)

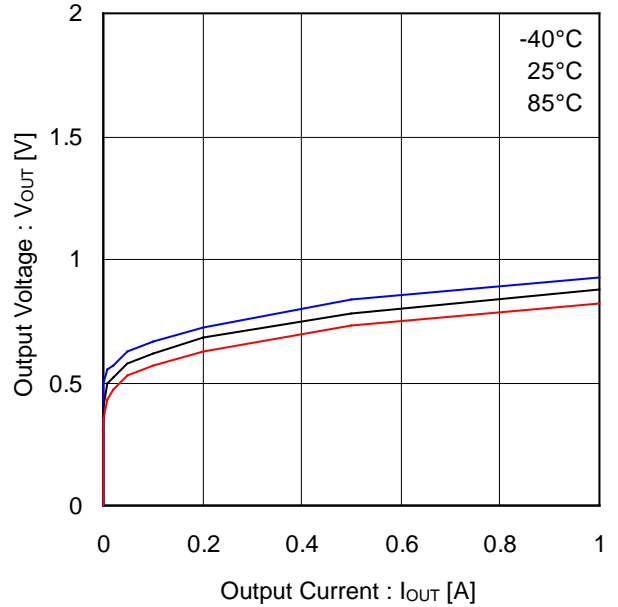

Figure 28. Output Voltage vs Output Current (Low Side Body Diode, BD6211)

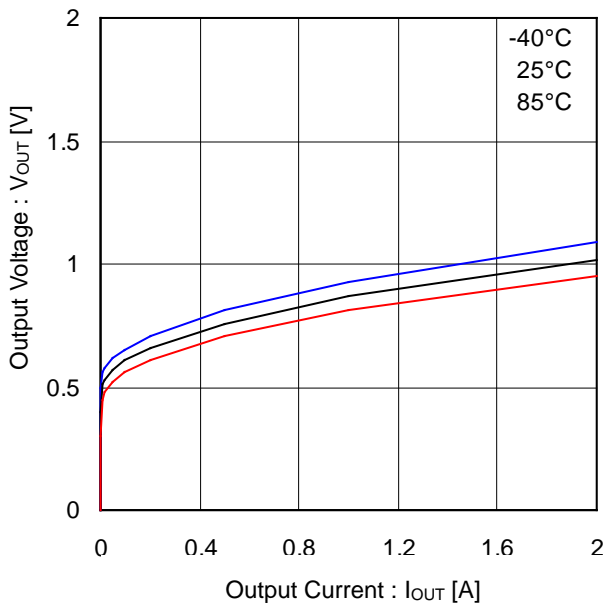

Figure 29. Output Voltage vs Output Current (Low Side Body Diode, BD6212)

Application Information

1. Description of Functions

(1) Operation Modes

Table 4 Logic table

Mode	FIN	RIN	VREF	OUT1	OUT2	Operation
a	L	L	X	Hi-Z <sup>(Note)</sup>	Hi-Z <sup>(Note)</sup>	Stand-by (idling)
b	H	L	VCC	H	L	Forward (OUT1 > OUT2)
c	L	H	VCC	L	H	Reverse (OUT1 < OUT2)
d	H	H	X	L	L	Brake (stop)
e	PWM	L	VCC	H	PWM	Forward (PWM control mode A)
f	L	PWM	VCC	PWM	H	Reverse (PWM control mode A)
g	H	PWM	VCC	PWM	L	Forward (PWM control mode B)
h	PWM	H	VCC	L	PWM	Reverse (PWM control mode B)
i	H	L	Option	H	PWM	Forward (VREF control)
j	L	H	Option	PWM	H	Reverse (VREF control)

(Note)Hi-Z : all output transistors are off. Please note that this is the state of the connected diodes, which differs from that of the mechanical relay.  
X : Don't care

Mode (a) Stand-by Mode

Stand-by operates independently with the VREF pin voltage. In stand-by mode, all internal circuits are turned OFF, including the output power transistors. Motor output goes to high impedance state. When the system is switched to stand-by mode while the motor is running, the system enters an idling state because of the body diodes. However, when the system switches to stand-by from any other mode (except the brake mode), the control logic remains in the HIGH state for at least 50µs before shutting down all circuits.

Mode (b) Forward Mode

This operating mode is defined as the forward rotation of the motor when OUT1 pin is HIGH and OUT2 pin is LOW. When the motor is connected between OUT1 and OUT2 pins, the current flows from OUT1 to OUT2. To operate in this mode, connect the VREF pin to the VCC pin.

Mode (c) Reverse Mode

This operating mode is defined as the reverse rotation of the motor when OUT1 pin is low and OUT2 pin is high. When the motor is connected between OUT1 and OUT2 pins, the current flows from OUT2 to OUT1. To operate in this mode, connect the VREF pin to the VCC pin.

Mode (d) Brake Mode

This operating mode is used to quickly stop the motor (short circuit brake). It differs from the stand-by mode because the internal control circuit is operating in the brake mode. Please switch to stand-by mode (rather than the brake mode) to save power and reduce consumption.

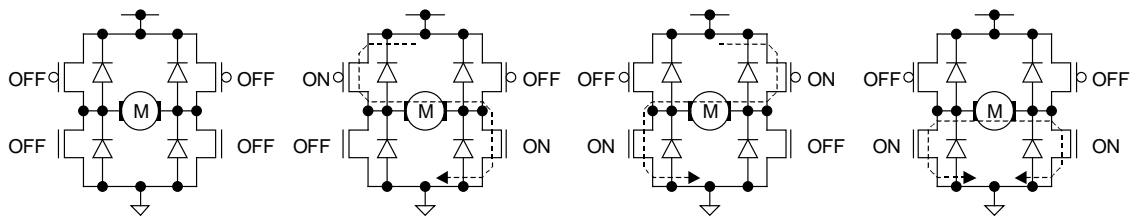

(a) Stand-by Mode

(b) Forward Mode

(c) Reverse Mode

(d) Brake Mode

Figure 30. Four Basic Operations (Output Stage)

Mode (e),(f) PWM Control Mode A

The rotational speed of the motor can be controlled by the duty cycle of the PWM signal fed to the FIN pin or the RIN pin. In this mode, the high side output is fixed and the low side output is switching, corresponding to the input signal. The state of the output toggles between "L" and "Hi-Z".

The frequency of the input PWM signal can be between 20kHz and 100kHz. The circuit may not operate properly for PWM frequencies below 20kHz and above 100kHz. Note that control may not be attained by switching on duty at frequencies lower than 20kHz, since the operation functions via the stand-by mode. To operate in this mode, connect the VREF pin to the VCC pin. In addition, establish a current path for the recovery current from the motor, by connecting a bypass capacitor (10µF or higher is recommended) between VCC and ground.



Figure 31. PWM Control Mode A Operation (Output Stage)

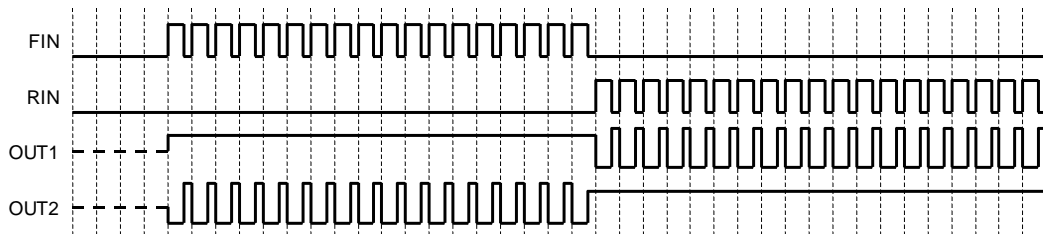

Figure 32. PWM Control Mode A Operation (Timing Chart)

Mode (g),(h) PWM Control Mode B

The rotational speed of the motor can be controlled by the duty cycle of the PWM signal fed to the FIN pin or the RIN pin. In this mode, the low side output is fixed and the high side output is switching, corresponding to the input signal. The state of the output toggles between "L" and "H".

The frequency of the input PWM signal can be between 20kHz and 100kHz. The circuit may not operate properly for PWM frequencies below 20kHz and above 100kHz. To operate in this mode, connect the VREF pin to the VCC pin. In addition, establish a current path for the recovery current from the motor, by connecting a bypass capacitor (10µF or higher is recommended) between VCC and ground.

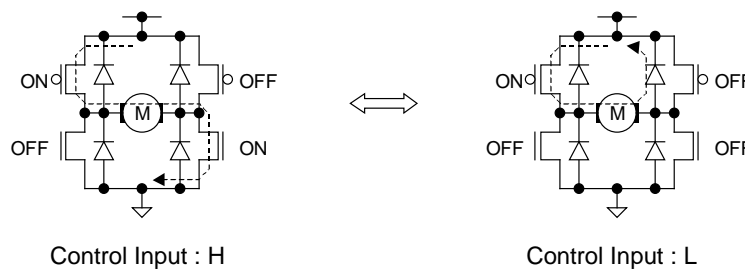

Figure 33. PWM Control Mode B Operation (Output Stage)

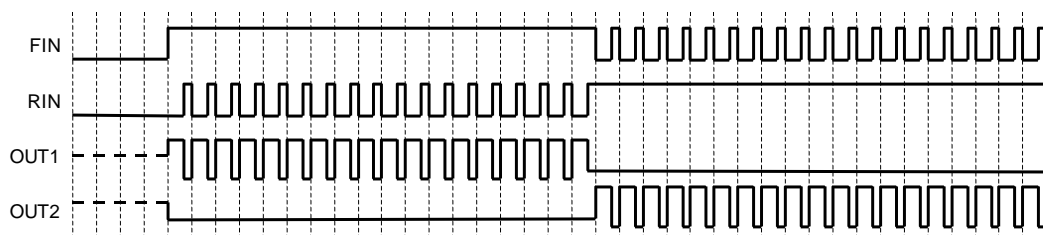

Figure 34. PWM Control Mode B Operation (Timing Chart)

## Mode (i),(j) VREF Control Mode

The built-in VREF duty cycle conversion circuit provides a duty cycle corresponding to the voltage of the VREF pin and the VCC voltage. The function offers the same level of control as the high voltage output setting function in previous models. The duty cycle is calculated by the following equation.

$$DUTY \approx V_{REF} [V] / V_{CC} [V]$$

For example, if VCC voltage is 5V and VREF pin voltage is 3.75V, the duty cycle is about 75 percent. However, please note that the duty cycle might be limited by the range of the VREF pin voltage (Refer to the recommended operating conditions, shown on page 3). The PWM carrier frequency in this mode is 25kHz (nominal), and the switching operation is the same as the PWM control modes. When operating in this mode, do not input a PWM signal to the FIN and RIN pins. In addition, establish a current path for the recovery current from the motor, by connecting a bypass capacitor (10μF or more is recommended) between VCC and ground.



Figure 35. VREF Control Operation (Timing Chart)

## (2) Cross-Conduction Protection Circuit

In the full bridge output stage, when the upper and lower transistors are turned ON at the same time during high to low or low to high transition, an inrush current flows from the power supply to ground, resulting to a loss. This circuit eliminates the inrush current by providing a dead time (about 400ns, nominal) during the transition.

## (3) Output Protection Circuits

## (a) Under Voltage Lock Out (UVLO) Circuit

To ensure the lowest power supply voltage necessary to operate the controller, and to prevent under voltage malfunctions, a UVLO circuit has been built into this driver. When the power supply voltage falls to 2.3V (nominal), or below, the controller forces all driver outputs to high impedance state. When the voltage rises to 2.5V (nominal), or above, the UVLO circuit ends the lockout operation and returns the chip to its normal operation.

## (b) Over Voltage Protection (OVP) Circuit

When the power supply voltage exceeds 7.3V (nominal), the controller forces all driver outputs to high impedance state. The OVP circuit is released and its operation ends when the voltage drops back to 6.8V (nominal) or below. This protection circuit does not work in the stand-by mode. Also, note that this circuit is supplementary, and thus if it is asserted, the absolute maximum rating will have been exceeded. Therefore, do not continue to use the IC after this circuit is activated, and do not operate the IC in an environment where activation of the circuit is assumed.

## (c) Thermal Shutdown (TSD) Circuit

The TSD circuit operates when the junction temperature of the driver exceeds the preset temperature (175°C nominal). At this time, the controller forces all driver outputs to high impedance state. Since thermal hysteresis is provided by the TSD circuit, the chip returns to its normal operation when the junction temperature falls below the preset temperature (150°C nominal). Thus, it is a self-resetting circuit.

The TSD circuit is designed only to shut the IC off to prevent thermal runaway. It is not designed to protect the IC or guarantee its operation in the presence of extreme heat. Do not continue to use the IC after the TSD circuit is activated, and do not operate the IC in an environment where activation of the circuit is assumed.

(d) Over Current Protection (OCP) Circuit

To protect this driver IC from ground faults, power supply line faults and load short circuits, the OCP circuit monitors the output current for the circuit's monitoring time (10μs, nominal). When the protection circuit detects an over current, the controller forces all driver outputs to high impedance state during the off time (290μs, nominal). The IC returns to its normal operation after the time period has elapsed (self-returning type).



Figure 36. Over-Current Protection (Timing Chart)

I/O Equivalent Circuits



Figure 37. FIN / RIN

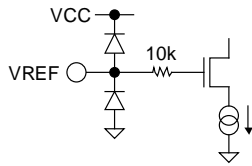

Figure 38. VREF

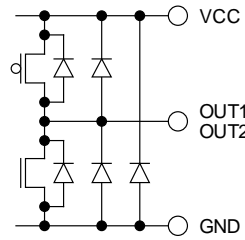

Figure 39. OUT1 / OUT2 (SOP8/HRP7)

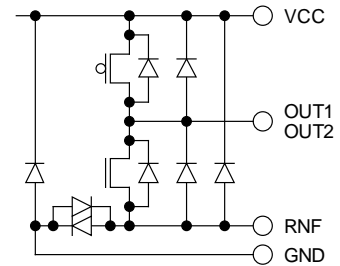

Figure 40. OUT1 / OUT2 (HSOP25)

## Operational Notes

### 1. Reverse Connection of Power Supply

Connecting the power supply in reverse polarity can damage the IC. Take precautions against reverse polarity when connecting the power supply, such as mounting an external diode between the power supply and the IC's power supply pins.

### 2. Power Supply Lines

Design the PCB layout pattern to provide low impedance supply lines. Separate the ground and supply lines of the digital and analog blocks to prevent noise in the ground and supply lines of the digital block from affecting the analog block. Furthermore, connect a capacitor to ground at all power supply pins. Consider the effect of temperature and aging on the capacitance value when using electrolytic capacitors.

### 3. Ground Voltage

Ensure that no pins are at a voltage below that of the ground pin at any time, even during transient condition.

### 4. Ground Wiring Pattern

When using both small-signal and large-current ground traces, the two ground traces should be routed separately but connected to a single ground at the reference point of the application board to avoid fluctuations in the small-signal ground caused by large currents. Also ensure that the ground traces of external components do not cause variations on the ground voltage. The ground lines must be as short and thick as possible to reduce line impedance.

### 5. Thermal Consideration

Should by any chance the power dissipation rating be exceeded the rise in temperature of the chip may result in deterioration of the properties of the chip. In case of exceeding this absolute maximum rating, increase the board size and copper area to prevent exceeding the Pd rating.

### 6. Recommended Operating Conditions

These conditions represent a range within which the expected characteristics of the IC can be approximately obtained. The electrical characteristics are guaranteed under the conditions of each parameter.

### 7. Inrush Current

When power is first supplied to the IC, it is possible that the internal logic may be unstable and inrush current may flow instantaneously due to the internal powering sequence and delays, especially if the IC has more than one power supply. Therefore, give special consideration to power coupling capacitance, power wiring, width of ground wiring, and routing of connections.

### 8. Operation Under Strong Electromagnetic Field

Operating the IC in the presence of a strong electromagnetic field may cause the IC to malfunction.

### 9. Testing on Application Boards

When testing the IC on an application board, connecting a capacitor directly to a low-impedance output pin may subject the IC to stress. Always discharge capacitors completely after each process or step. The IC's power supply should always be turned off completely before connecting or removing it from the test setup during the inspection process. To prevent damage from static discharge, ground the IC during assembly and use similar precautions during transport and storage.

### 10. Inter-pin Short and Mounting Errors

Ensure that the direction and position are correct when mounting the IC on the PCB. Incorrect mounting may result in damaging the IC. Avoid nearby pins being shorted to each other especially to ground, power supply and output pin. Inter-pin shorts could be due to many reasons such as metal particles, water droplets (in very humid environment) and unintentional solder bridge deposited in between pins during assembly to name a few.

### 11. Unused Input Pins

Input pins of an IC are often connected to the gate of a MOS transistor. The gate has extremely high impedance and extremely low capacitance. If left unconnected, the electric field from the outside can easily charge it. The small charge acquired in this way is enough to produce a significant effect on the conduction through the transistor and cause unexpected operation of the IC. So unless otherwise specified, unused input pins should be connected to the power supply or ground line.

## Operational Notes – continued

## 12. Regarding the Input Pin of the IC

This monolithic IC contains P+ isolation and P substrate layers between adjacent elements in order to keep them isolated. P-N junctions are formed at the intersection of the P layers with the N layers of other elements, creating a parasitic diode or transistor. For example (refer to figure below):

When GND > Pin A and GND > Pin B, the P-N junction operates as a parasitic diode.

When GND > Pin B, the P-N junction operates as a parasitic transistor.

Parasitic diodes inevitably occur in the structure of the IC. The operation of parasitic diodes can result in mutual interference among circuits, operational faults, or physical damage. Therefore, conditions that cause these diodes to operate, such as applying a voltage lower than the GND voltage to an input pin (and thus to the P substrate) should be avoided.



Figure 41. Example of monolithic IC structure

## 13. Area of Safe Operation (ASO)

Operate the IC such that the output voltage, output current, and power dissipation are all within the Area of Safe Operation (ASO).

## 14. Power supply lines2

Return current generated by the motor's Back-EMF requires countermeasures, such as providing a return current path by inserting capacitors across the power supply and GND (10 $\mu$ F, ceramic capacitor is recommended). In this case, it is important to conclusively confirm that none of the negative effects sometimes seen with electrolytic capacitors – including a capacitance drop at low temperatures - occurs. Also, the connected power supply must have sufficient current absorbing capability. Otherwise, the regenerated current will increase voltage on the power supply line, which may in turn cause problems with the product, including peripheral circuits exceeding the absolute maximum rating. To help protect against damage or degradation, physical safety measures should be taken, such as providing a voltage clamping diode across the power supply and GND.

## 15. Capacitor Between Output and Ground

If a large capacitor is connected between the output pin and ground pin, current from the charged capacitor can flow into the output pin and may destroy the IC when the VCC or VIN pin is shorted to ground or pulled down to 0V. Use a capacitor smaller than 10 $\mu$ F between output and ground.

## 16. Switching Noise

When the operation mode is in PWM control or VREF control, PWM switching noise may affect the control input pins and cause IC malfunctions. In this case, insert a pull down resistor (10k $\Omega$  is recommended) between each control input pin and ground.

Marking Diagrams

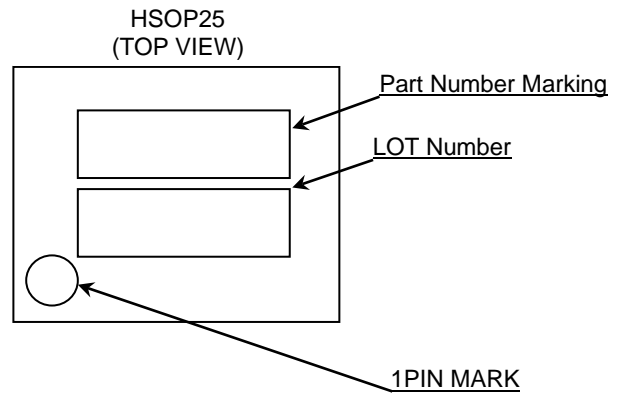

Part Number	Package	Part Number Marking
BD6210HFP	HRP7	BD6210HFP
BD6210F	SOP8	6210
BD6211HFP	HRP7	BD6211HFP
BD6211F	SOP8	6211
BD6212HFP	HRP7	BD6212HFP
BD6212FP	HSOP25	BD6212FP



Physical Dimension, Tape and Reel Information

Package Name	SOP8
--------------	------



(UNIT : mm)  
 PKG : SOP8  
 Drawing No. : EX112-5001-1



Physical Dimension, Tape and Reel Information - continued

Package Name	HSOP25
--------------	--------

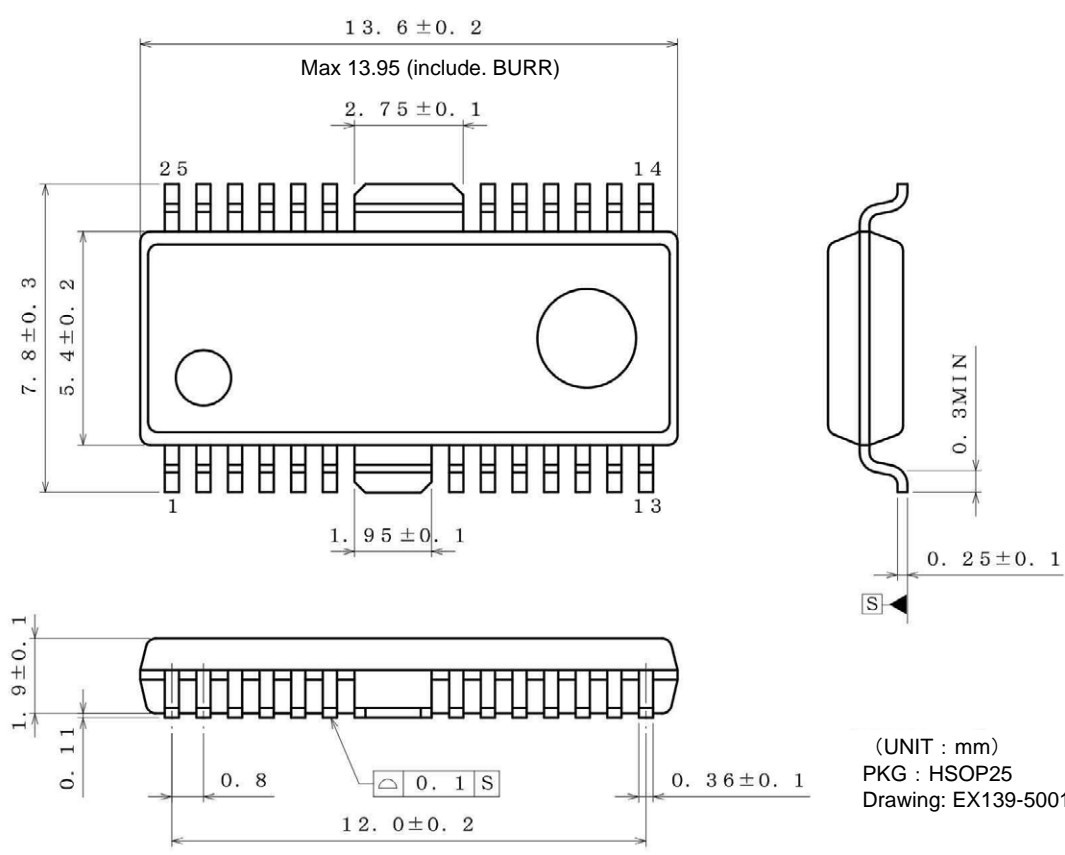

(UNIT : mm)  
 PKG : HSOP25  
 Drawing: EX139-5001

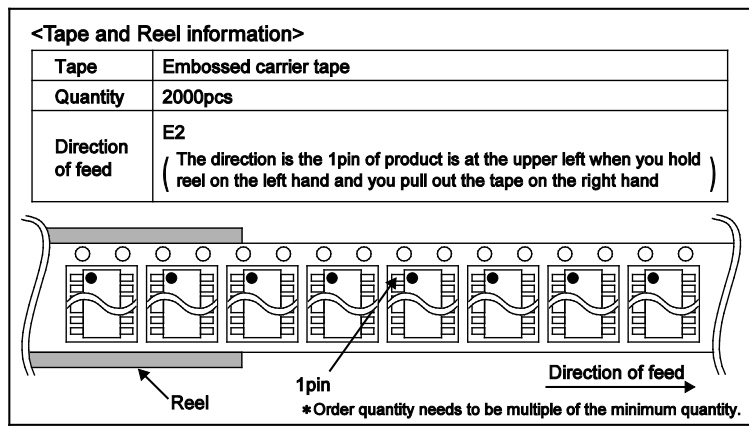

Physical Dimension, Tape and Reel Information - continued

Package Name	HRP7
--------------	------

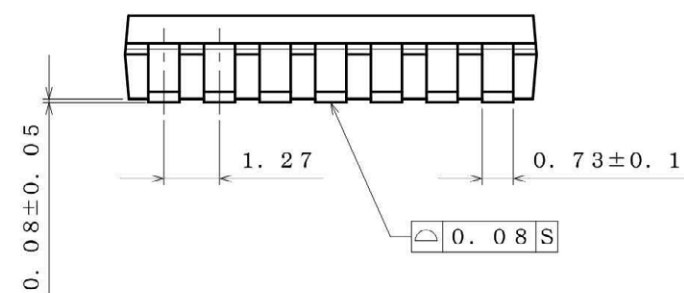
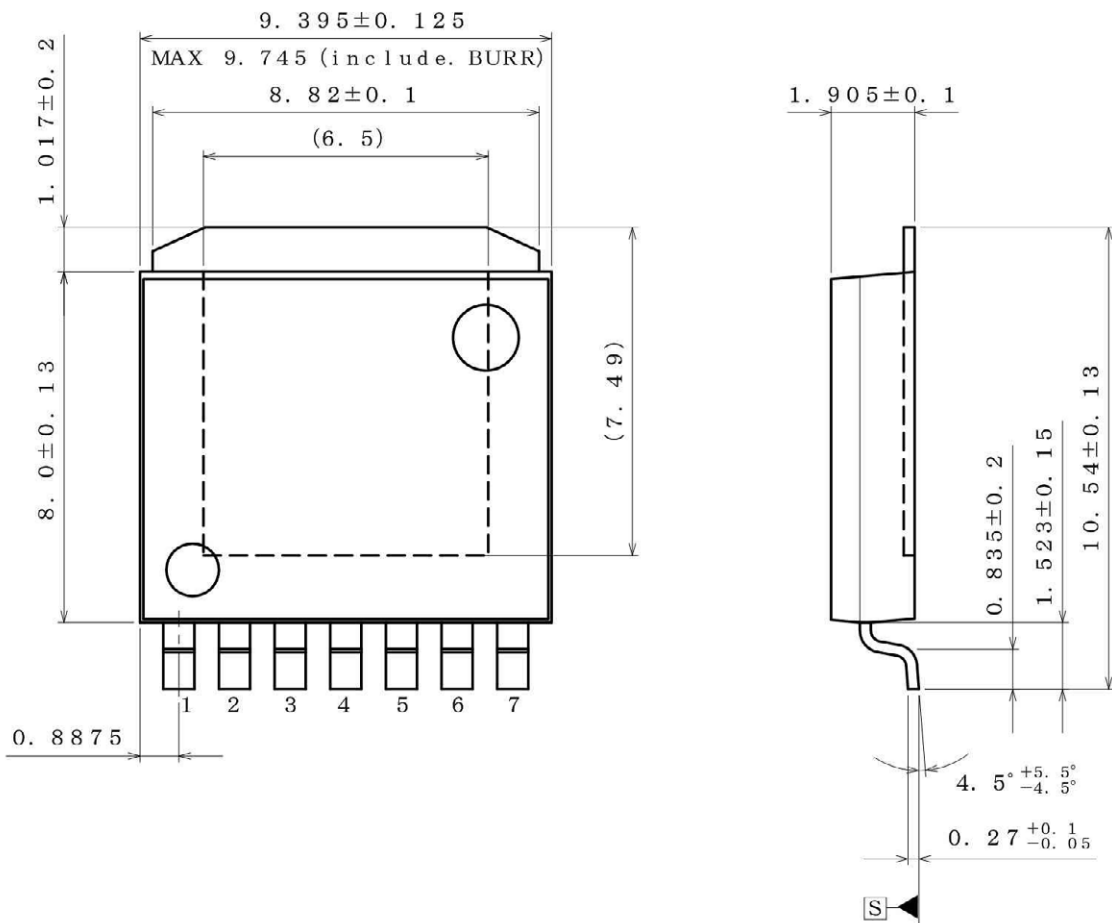

(UNIT ; mm)  
 PKG : HRP7  
 Drawing No. EX542-5002-2

< Tape and Reel Information >

Tape	Embossed carrier tape
Quantity	2000pcs
Direction of feed	TR The direction is the pin 1 of product is at the upper right when you hold reel on the left hand and you pull out the tape on the right hand

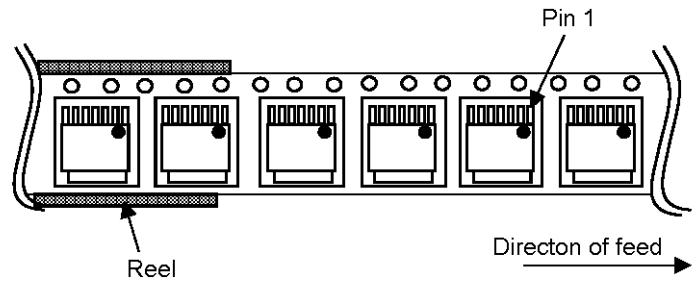

**Revision History**

Date	Revision	Changes
14.Mar.2012	001	New Release
25.Dec.2012	002	Improved the statement in all pages. Deleted "Status of this document" in page 11.
09.Sep.2014	003	Applied the ROHM Standard Style. Improved Operational Notes.

# Notice

## Precaution on using ROHM Products

- Our Products are designed and manufactured for application in ordinary electronic equipments (such as AV equipment, OA equipment, telecommunication equipment, home electronic appliances, amusement equipment, etc.). If you intend to use our Products in devices requiring extremely high reliability (such as medical equipment <sup>(Note 1)</sup>, transport equipment, traffic equipment, aircraft/spacecraft, nuclear power controllers, fuel controllers, car equipment including car accessories, safety devices, etc.) and whose malfunction or failure may cause loss of human life, bodily injury or serious damage to property ("Specific Applications"), please consult with the ROHM sales representative in advance. Unless otherwise agreed in writing by ROHM in advance, ROHM shall not be in any way responsible or liable for any damages, expenses or losses incurred by you or third parties arising from the use of any ROHM's Products for Specific Applications.

(Note1) Medical Equipment Classification of the Specific Applications

JAPAN	USA	EU	CHINA
CLASS III	CLASS III	CLASS II b	CLASS III
CLASS IV		CLASS III	

- ROHM designs and manufactures its Products subject to strict quality control system. However, semiconductor products can fail or malfunction at a certain rate. Please be sure to implement, at your own responsibilities, adequate safety measures including but not limited to fail-safe design against the physical injury, damage to any property, which a failure or malfunction of our Products may cause. The following are examples of safety measures:
  - Installation of protection circuits or other protective devices to improve system safety
  - Installation of redundant circuits to reduce the impact of single or multiple circuit failure
- Our Products are designed and manufactured for use under standard conditions and not under any special or extraordinary environments or conditions, as exemplified below. Accordingly, ROHM shall not be in any way responsible or liable for any damages, expenses or losses arising from the use of any ROHM's Products under any special or extraordinary environments or conditions. If you intend to use our Products under any special or extraordinary environments or conditions (as exemplified below), your independent verification and confirmation of product performance, reliability, etc. prior to use, must be necessary:
  - Use of our Products in any types of liquid, including water, oils, chemicals, and organic solvents
  - Use of our Products outdoors or in places where the Products are exposed to direct sunlight or dust
  - Use of our Products in places where the Products are exposed to sea wind or corrosive gases, including Cl<sub>2</sub>, H<sub>2</sub>S, NH<sub>3</sub>, SO<sub>2</sub>, and NO<sub>2</sub>
  - Use of our Products in places where the Products are exposed to static electricity or electromagnetic waves
  - Use of our Products in proximity to heat-producing components, plastic cords, or other flammable items
  - Sealing or coating our Products with resin or other coating materials
  - Use of our Products without cleaning residue of flux (even if you use no-clean type fluxes, cleaning residue of flux is recommended); or Washing our Products by using water or water-soluble cleaning agents for cleaning residue after soldering
  - Use of the Products in places subject to dew condensation
- The Products are not subject to radiation-proof design.
- Please verify and confirm characteristics of the final or mounted products in using the Products.
- In particular, if a transient load (a large amount of load applied in a short period of time, such as pulse. is applied, confirmation of performance characteristics after on-board mounting is strongly recommended. Avoid applying power exceeding normal rated power; exceeding the power rating under steady-state loading condition may negatively affect product performance and reliability.
- De-rate Power Dissipation (Pd) depending on Ambient temperature (Ta). When used in sealed area, confirm the actual ambient temperature.
- Confirm that operation temperature is within the specified range described in the product specification.
- ROHM shall not be in any way responsible or liable for failure induced under deviant condition from what is defined in this document.

## Precaution for Mounting / Circuit board design

- When a highly active halogenous (chlorine, bromine, etc.) flux is used, the residue of flux may negatively affect product performance and reliability.
- In principle, the reflow soldering method must be used; if flow soldering method is preferred, please consult with the ROHM representative in advance.

For details, please refer to ROHM Mounting specification

**Precautions Regarding Application Examples and External Circuits**

1. If change is made to the constant of an external circuit, please allow a sufficient margin considering variations of the characteristics of the Products and external components, including transient characteristics, as well as static characteristics.
2. You agree that application notes, reference designs, and associated data and information contained in this document are presented only as guidance for Products use. Therefore, in case you use such information, you are solely responsible for it and you must exercise your own independent verification and judgment in the use of such information contained in this document. ROHM shall not be in any way responsible or liable for any damages, expenses or losses incurred by you or third parties arising from the use of such information.

**Precaution for Electrostatic**

This Product is electrostatic sensitive product, which may be damaged due to electrostatic discharge. Please take proper caution in your manufacturing process and storage so that voltage exceeding the Products maximum rating will not be applied to Products. Please take special care under dry condition (e.g. Grounding of human body / equipment / solder iron, isolation from charged objects, setting of Ionizer, friction prevention and temperature / humidity control).

**Precaution for Storage / Transportation**

1. Product performance and soldered connections may deteriorate if the Products are stored in the places where:
  - [a] the Products are exposed to sea winds or corrosive gases, including Cl<sub>2</sub>, H<sub>2</sub>S, NH<sub>3</sub>, SO<sub>2</sub>, and NO<sub>2</sub>
  - [b] the temperature or humidity exceeds those recommended by ROHM
  - [c] the Products are exposed to direct sunshine or condensation
  - [d] the Products are exposed to high Electrostatic
2. Even under ROHM recommended storage condition, solderability of products out of recommended storage time period may be degraded. It is strongly recommended to confirm solderability before using Products of which storage time is exceeding the recommended storage time period.
3. Store / transport cartons in the correct direction, which is indicated on a carton with a symbol. Otherwise bent leads may occur due to excessive stress applied when dropping of a carton.
4. Use Products within the specified time after opening a humidity barrier bag. Baking is required before using Products of which storage time is exceeding the recommended storage time period.

**Precaution for Product Label**

QR code printed on ROHM Products label is for ROHM's internal use only.

**Precaution for Disposition**

When disposing Products please dispose them properly using an authorized industry waste company.

**Precaution for Foreign Exchange and Foreign Trade act**

Since our Products might fall under controlled goods prescribed by the applicable foreign exchange and foreign trade act, please consult with ROHM representative in case of export.

**Precaution Regarding Intellectual Property Rights**

1. All information and data including but not limited to application example contained in this document is for reference only. ROHM does not warrant that foregoing information or data will not infringe any intellectual property rights or any other rights of any third party regarding such information or data. ROHM shall not be in any way responsible or liable for infringement of any intellectual property rights or other damages arising from use of such information or data.:
2. No license, expressly or implied, is granted hereby under any intellectual property rights or other rights of ROHM or any third parties with respect to the information contained in this document.

**Other Precaution**

1. This document may not be reprinted or reproduced, in whole or in part, without prior written consent of ROHM.
2. The Products may not be disassembled, converted, modified, reproduced or otherwise changed without prior written consent of ROHM.
3. In no event shall you use in any way whatsoever the Products and the related technical information contained in the Products or this document for any military purposes, including but not limited to, the development of mass-destruction weapons.
4. The proper names of companies or products described in this document are trademarks or registered trademarks of ROHM, its affiliated companies or third parties.

**General Precaution**

1. Before you use our Products, you are requested to carefully read this document and fully understand its contents. ROHM shall not be in any way responsible or liable for failure, malfunction or accident arising from the use of any ROHM's Products against warning, caution or note contained in this document.
2. All information contained in this document is current as of the issuing date and subject to change without any prior notice. Before purchasing or using ROHM's Products, please confirm the latest information with a ROHM sales representative.
3. The information contained in this document is provided on an "as is" basis and ROHM does not warrant that all information contained in this document is accurate and/or error-free. ROHM shall not be in any way responsible or liable for any damages, expenses or losses incurred by you or third parties resulting from inaccuracy or errors of or concerning such information.

# Mouser Electronics

Authorized Distributor

Click to View Pricing, Inventory, Delivery & Lifecycle Information:

[ROHM Semiconductor:](#)

[BD6211HFP-TR](#) [BD6210F-E2](#) [BD6212FP-E2](#) [BD6212HFP-TR](#) [BD6211F-E2](#) [BD6210HFP-TR](#)



Компания «Океан Электроники» предлагает заключение долгосрочных отношений при поставках импортных электронных компонентов на взаимовыгодных условиях!

Наши преимущества:

- Поставка оригинальных импортных электронных компонентов напрямую с производств Америки, Европы и Азии, а так же с крупнейших складов мира;
- Широкая линейка поставок активных и пассивных импортных электронных компонентов (более 30 млн. наименований);
- Поставка сложных, дефицитных, либо снятых с производства позиций;
- Оперативные сроки поставки под заказ (от 5 рабочих дней);
- Экспресс доставка в любую точку России;
- Помощь Конструкторского Отдела и консультации квалифицированных инженеров;
- Техническая поддержка проекта, помощь в подборе аналогов, поставка прототипов;
- Поставка электронных компонентов под контролем ВП;
- Система менеджмента качества сертифицирована по Международному стандарту ISO 9001;
- При необходимости вся продукция военного и аэрокосмического назначения проходит испытания и сертификацию в лаборатории (по согласованию с заказчиком);
- Поставка специализированных компонентов военного и аэрокосмического уровня качества (Xilinx, Altera, Analog Devices, Intersil, Interpoint, Microsemi, Actel, Aeroflex, Peregrine, VPT, Syfer, Eurofarad, Texas Instruments, MS Kennedy, Miteq, Cobham, E2V, MA-COM, Hittite, Mini-Circuits, General Dynamics и др.);

Компания «Океан Электроники» является официальным дистрибьютором и эксклюзивным представителем в России одного из крупнейших производителей разъемов военного и аэрокосмического назначения «JONHON», а так же официальным дистрибьютором и эксклюзивным представителем в России производителя высокотехнологичных и надежных решений для передачи СВЧ сигналов «FORSTAR».



## JONHON

«JONHON» (основан в 1970 г.)

Разъемы специального, военного и аэрокосмического назначения:

(Применяются в военной, авиационной, аэрокосмической, морской, железнодорожной, горно- и нефтедобывающей отраслях промышленности)

«FORSTAR» (основан в 1998 г.)

ВЧ соединители, коаксиальные кабели, кабельные сборки и микроволновые компоненты:

(Применяются в телекоммуникациях гражданского и специального назначения, в средствах связи, РЛС, а так же военной, авиационной и аэрокосмической отраслях промышленности).



Телефон: 8 (812) 309-75-97 (многоканальный)

Факс: 8 (812) 320-03-32

Электронная почта: [ocean@oceanchips.ru](mailto:ocean@oceanchips.ru)

Web: <http://oceanchips.ru/>

Адрес: 198099, г. Санкт-Петербург, ул. Калинина, д. 2, корп. 4, лит. А