

Power Path with Input Current Limit and Capacitor Charger

General Description

The AAT4710 is a programmed, current limited P-channel MOSFET power switch designed for high-side load-switching applications for SSD memory buffer saving solutions. With the programmed current limit, the AAT4710 ensures that the power ratings of the host are not exceeded and balances the system load and supercap charging current automatically to provide enough system load current in top-priority. The integrated discharge path control assures that the system load can still be supported in the short term when the input power has not fully charged the supercap. The current limit is programmed by an external resistor allowing $\pm 10\%$ accuracy at room temperature.

The AAT4710 integrates discharge path for SYS (to system load) from VCC input or OUT input (connect to supercap). The low $R_{DS(ON)}$ from OUT to SYS prolongs the supercap backup time when VCC drops below a threshold voltage which is programmed by an external resistor from ADJ to ground.

The AAT4710 incorporates a POK function which can indicate system input power good. An ADJ pin is provided with the addition of an external resistor for setting the input power good detect threshold. The AAT4710 also incorporates a supercap charge ready (RDY) indicate function. The quiescent supply current is typically a low $70\mu A$ from the discharge path of VCC to SYS.

The AAT4710 is available in a 16-pin TDFN34 package and is specified over a -40 to $85^\circ C$ temperature range.

Features

- V_{CC} Range: 2.5V – 5.5V
- Input Current Limits:
 - 75 - 1200mA
 - $\pm 10\%$ Current Accuracy at 1A Input Current Limit Setting
- Low Quiescent Current:
 - $70\mu A$ Typical (VCC Input)
 - $12\mu A$ Typical (OUT Input)
- Under-Voltage Lockout
- Integrated Discharge Path for SYS (to System Load) from VCC Input or OUT Input (Connect to Supercap)
- Maximum $100m\Omega$ $R_{DS(ON)}$ from OUT to SYS at 5V V_{CC}
- Reverse Blocking Protection
- Power Loop Current Reduction
- Over-Temperature Protection
- SYS Short Circuit Protection
- Input Power Good Detect Threshold Setting (ADJ)
- Input Power Good Indicate (POK)
- Supercap Charge Ready (RDY) Output
- Temperature Range: -40 to $85^\circ C$
- 16-Pin TDFN34 Package

Applications

- SSD

Typical Application

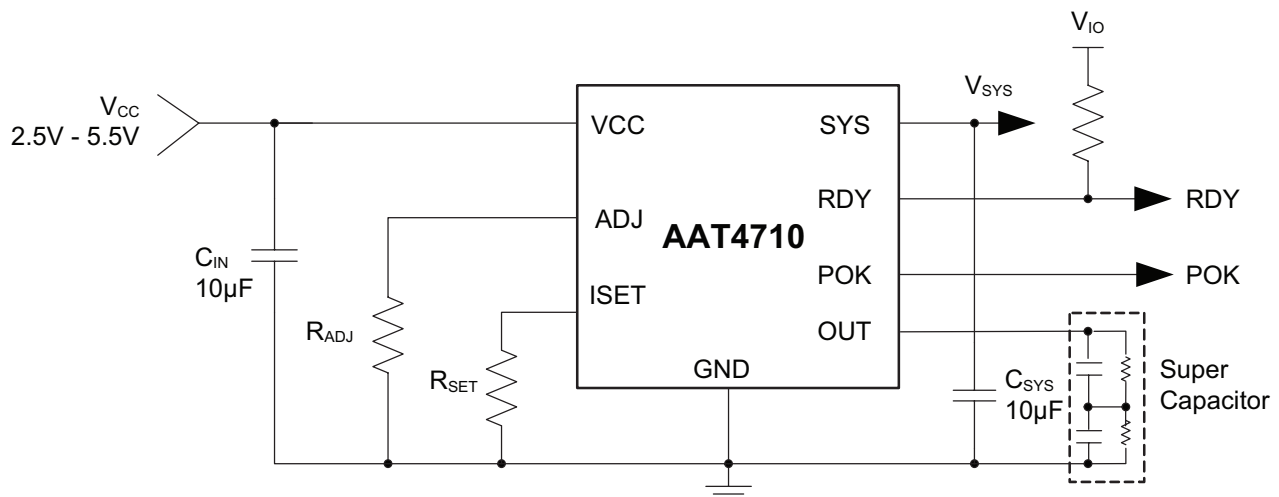

AAT4710

Power Path with Input Current Limit and Capacitor Charger

Pin Descriptions

Pin #	Symbol	Function
1	RDY	Supercap charge ready output, initiated when the capacitor is 98% charged. Open drain, active high.
2	ISET	Input current-limit set input. A resistor from ISET to ground is necessary and sets the maximum current limit for the switch. The current limit can be programmed from 75mA to 1200mA.
3	N/C	No connect.
4, 5, 6, 7, 8	SYS	System power output supplied from the VCC input or OUT input.
9, 10, 11	OUT	Connect to super capacitor from OUT to GND.
12, 13	VCC	Input pins to the P-channel MOSFET source. Connect a 10µF capacitor from VCC to GND.
14	ADJ	Input power good detect threshold. An internal 50kΩ resistor is integrated between ADJ and VCC.
15	GND	Device ground connection.
16	POK	Input power good indicator. Push pull, active high.

Pin Configuration

**TDFN34-16
(Top View)**

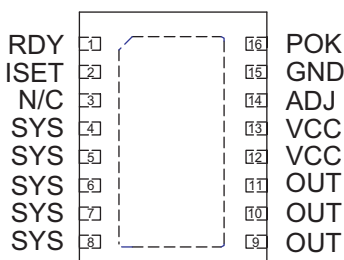

AAT4710**Power Path with Input Current Limit and Capacitor Charger****Absolute Maximum Ratings¹**

Symbol	Description	Value	Units
V_P	VCC, OUT to GND	-0.3 to 6	V
$V_{RDY}, V_{POK}, V_{ADJ}$	RDY, POK, ADJ to GND	-0.3 to $V_P + 0.3$	V
V_{ISET}, V_{SYS}	ISET, SYS to GND	-0.3 to $V_P + 0.3$	V
I_{MAX}	Maximum Continuous Switch Current	2.5	A
T_J	Operating Junction Temperature Range	-40 to 150	°C
T_{STG}	Storage Temperature	-40 to 150	°C
T_{LEAD}	Maximum Soldering Temperature (at Leads)	300	°C

Thermal Characteristics

Symbol	Description	Value	Units
Θ_{JA}	Maximum Thermal Resistance ²	50	°C/W
P_D	Maximum Power Dissipation ²	2	W

1. Stresses above those listed in Absolute Maximum Ratings may cause permanent damage to the device. Functional operation at conditions other than the operating conditions specified is not implied. Only one Absolute Maximum Rating should be applied at any one time.
2. Mounted on a FR4 board.

Power Path with Input Current Limit and Capacitor Charger

Electrical Characteristics¹

$V_{CC} = 2.5V$ to $5.5V$, $T_A = -40^{\circ}C$ to $85^{\circ}C$ unless otherwise noted. Typical values are at $T_A = 25^{\circ}C$

Symbol	Description	Conditions	Min	Typ	Max	Units
V_{CC}	Normal Operation Voltage		2.5		5.5	V
I_Q	V_{CC} Quiescent Current	$I_{OUT} = 0$, No Load at SYS Pin		70	120	μA
I_{OUT_OP}	OUT Operating Current	$V_{OUT} = 5V$, $V_{CC} = GND$, No Load at SYS Pin		12	30	μA
V_{UVLO_VCC}	V_{CC} Under-Voltage Lockout	Falling Edge		2.1	2.4	V
		Hysteresis		150		mV
V_{UVLO_OUT}	OUT Under-Voltage Lockout	Falling Edge		1.8	2	V
		Hysteresis		250		mV
$R_{DS(ON)_SWA}$	V_{CC} to SYS On-Resistance	$V_{CC} = 5V$, $R_{SET} = 1.24M\Omega$, $I_{LOAD} = 600mA$		50	100	m Ω
		$V_{CC} = 3.3V$, $R_{SET} = 1.24M\Omega$, $I_{LOAD} = 600mA$		65	120	
$R_{DS(ON)_SWB}$	V_{CC} to OUT On-Resistance	$V_{CC} = 5V$, $R_{SET} = 1.24M\Omega$, $I_{LOAD} = 600mA$		140	300	m Ω
		$V_{CC} = 3.3V$, $R_{SET} = 1.24M\Omega$, $I_{LOAD} = 600mA$		160	320	
$R_{DS(ON)_SWC}$	OUT to SYS On-Resistance	$V_{OUT} = 3V \sim 5V$			100	m Ω
$I_{LIMHACC}$	Input High Current Limit Accuracy	$R_{SET} = 1.24M\Omega$, $T_A = 25^{\circ}C$	900	1000	1100	mA
$I_{LIM(MIN)}$	Minimum Input Current Limit			75		mA
T_{RESP}	Current Limit Response Time	$V_{CC} = 5V$, $R_{SET} = 1.24M\Omega$		2		μs
$T_{DEL(OFF)}$	Turn-Off Delay Time	$V_{CC} = 5V$		0.4	10	μs
T_{SW}	OUT to SYS Switch Turn On Response Time	VCC Voltage Step-Down Signal from 5V to 4.5V		6		μs
V_{ADJ}	ADJ Pin Voltage with Trigger Comparator			1.2		V
T_{DETECT}	ADJ Pin Detect Delay Time	ADJ Voltage Step Down Signal from 1.3V to 1.1V		2		μs
$V_{POK(L)}$	Output Low Voltage	$ADJ \leq 1.2V$			0.4	V
$V_{POK(H)}$	Output High Voltage	$ADJ > 1.2V$	0.8 V_{CC}			V
V_{RDY}	Supercap Charge Ready Trip Threshold	V_{OUT} Rising, $T_A = 25^{\circ}C$		98		% of V_{CC}
V_{RDYSYS}	Supercap Charge Ready Hysteresis			200		mV
$V_{RDY(L)}$	RDY Output Low Voltage	RDY Pin Sinks 1mA			0.4	V
OTMP	Shutdown Temperature			145		$^{\circ}C$
T_{HYS}	Over-Temperature Shutdown Hysteresis			15		$^{\circ}C$

1. The AAT4710 is guaranteed to meet performance specifications over the $-40^{\circ}C$ to $85^{\circ}C$ operating temperature range and is assured by design, characterization and correlation with statistical process controls.

AAT4710

Power Path with Input Current Limit and Capacitor Charger

Typical Characteristics

V_{CC} Quiescent Current vs. Temperature

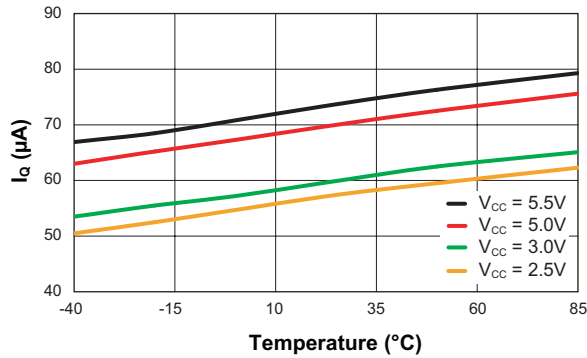

V_{OUT} Quiescent Current vs. Temperature

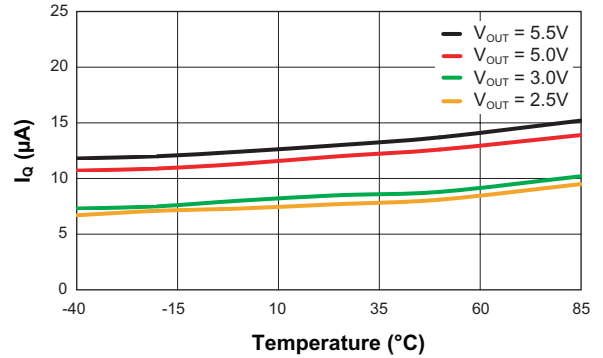

V_{UVLO_VCC} vs. Temperature

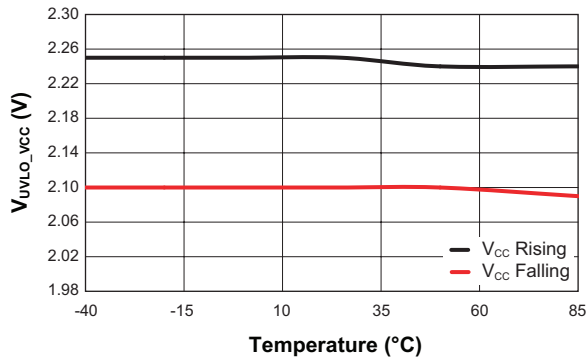

V_{UVLO_OUT} vs. Temperature

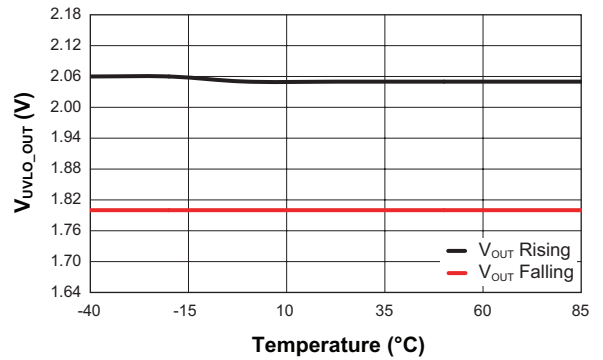

R_{DS(ON)_SWA} vs. Temperature
(Load Current = 600mA, R_{SET} = 1.24MΩ)

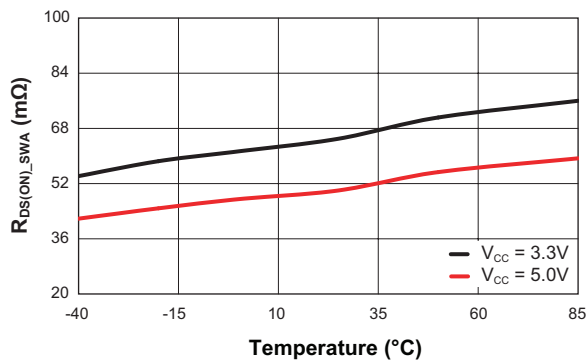

R_{DS(ON)_SWC} vs. Temperature
(Load Current = 600mA, R_{SET} = 1.24MΩ)

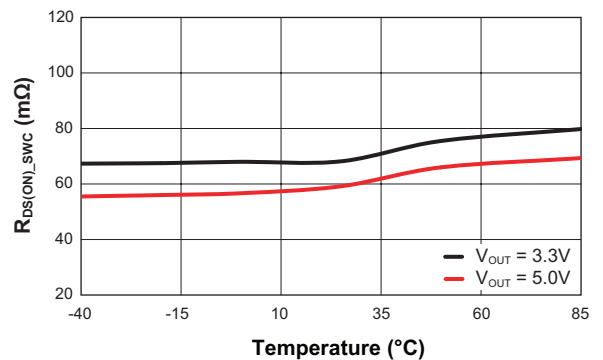

AAT4710

Power Path with Input Current Limit and Capacitor Charger

Typical Characteristics

$R_{DS(ON)}$ vs. Input Voltage
(Load Current = 600mA, $R_{SET} = 1.24M\Omega$)

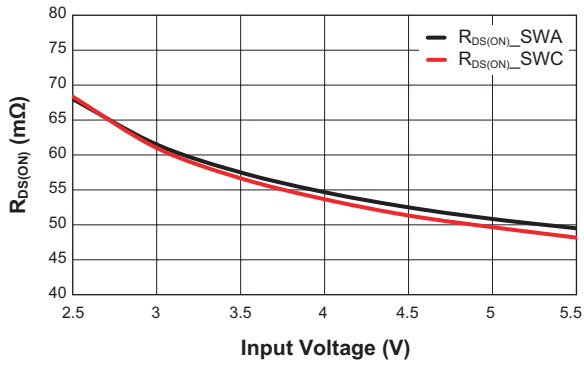

Current Limit Error vs. Temperature
($V_{CC} = 5.0V$, $R_{SET} = 1.24M\Omega$)

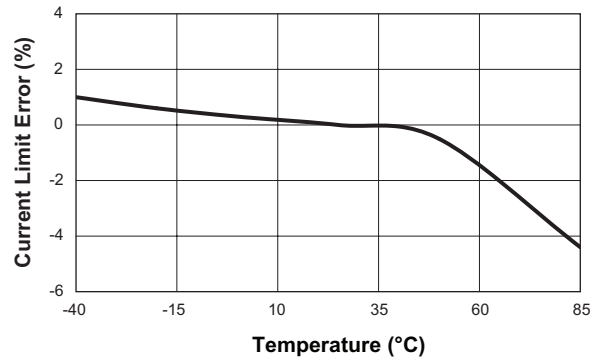

Current Limit vs. SYS Voltage
($R_{ADJ} = 18.2k\Omega$, $R_{SET} = 1.24M\Omega$, $C_{IN} = C_{SYS} = 10\mu F$)

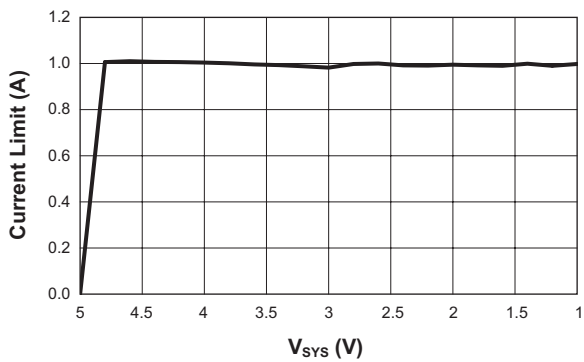

Current Limit vs. R_{SET}
($V_{CC} = 5.0V$)

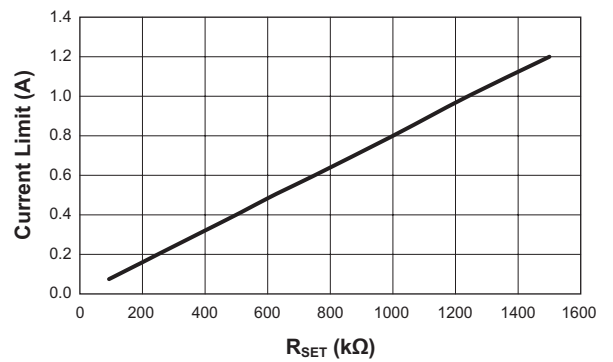

ADJ Detect Delay Time
($V_{CC} = 5.0V$, $R_{SET} = 1.24M\Omega$, $V_{ADJ} = 1.3V$ to $1.1V$)

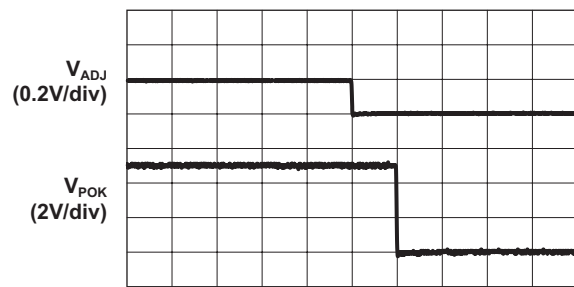

Time (0.8μs/div)

POK Delay Time
($R_{ADJ} = 18.2k\Omega$, $V_{CC} = 4V$ to $5V$)

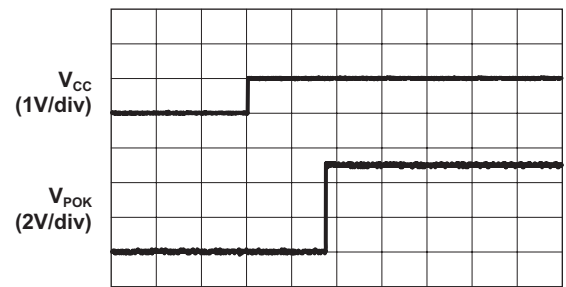

Time (100μs/div)

AAT4710

Power Path with Input Current Limit and Capacitor Charger

Typical Characteristics

RDY Delay Time From High to Low
($V_{CC} = 5.0V$, $R_{SET} = 1.24M\Omega$, $V_{OUT} = 5V$ to $4.5V$)

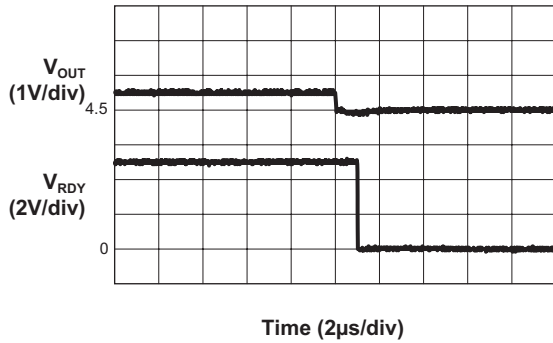

RDY Delay Time From Low to High
($V_{CC} = 5.0V$, $R_{SET} = 1.24M\Omega$, $V_{OUT} = 5V$ to $4.5V$)

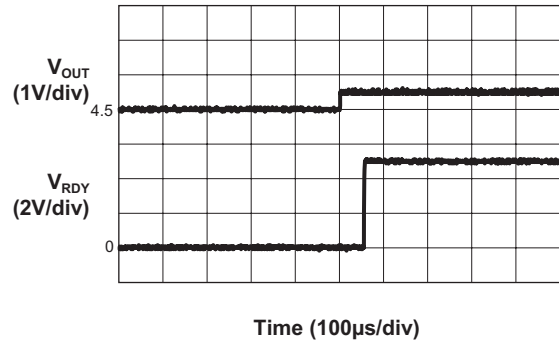

Current Limit Response
($V_{CC} = 5.0V$, $R_{SET} = 1.24M\Omega$, $R_{LOAD} = 10\Omega$ to 1Ω)

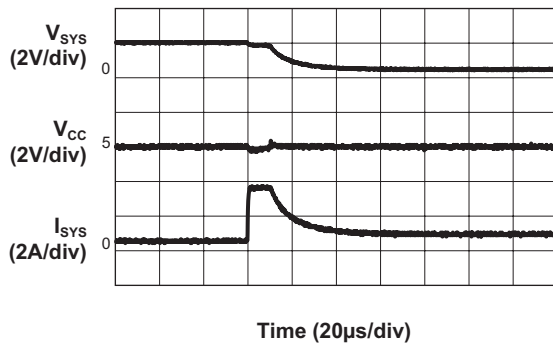

Load Transient
($V_{CC} = 5.0V$, $V_{OUT} = 2.0V$,
 $R_{SET} = 1.24M\Omega$, $I_{SYS} = 0.5A$ to $1A$)

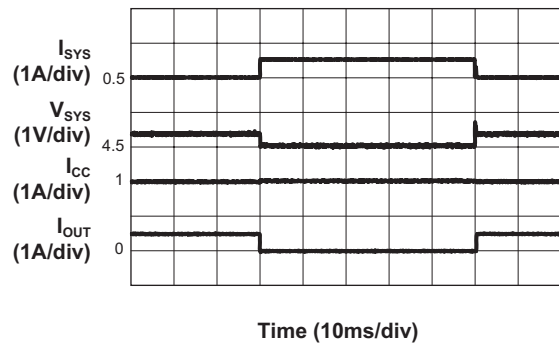

Discharge Path Switching
($V_{OUT} = 5.0V$, $R_{SET} = 1.24M\Omega$, $R_{ADJ} = 18.2k\Omega$,
 $V_{CC} = 5V$ to $4V$, $500mA$ Load)

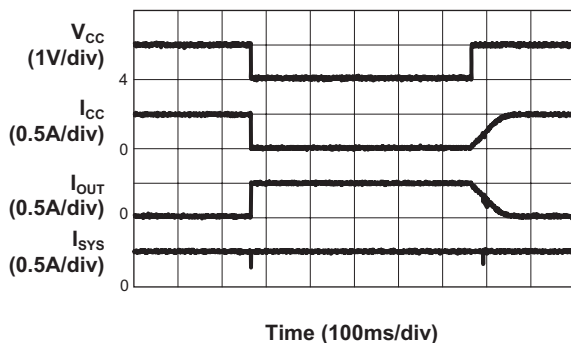

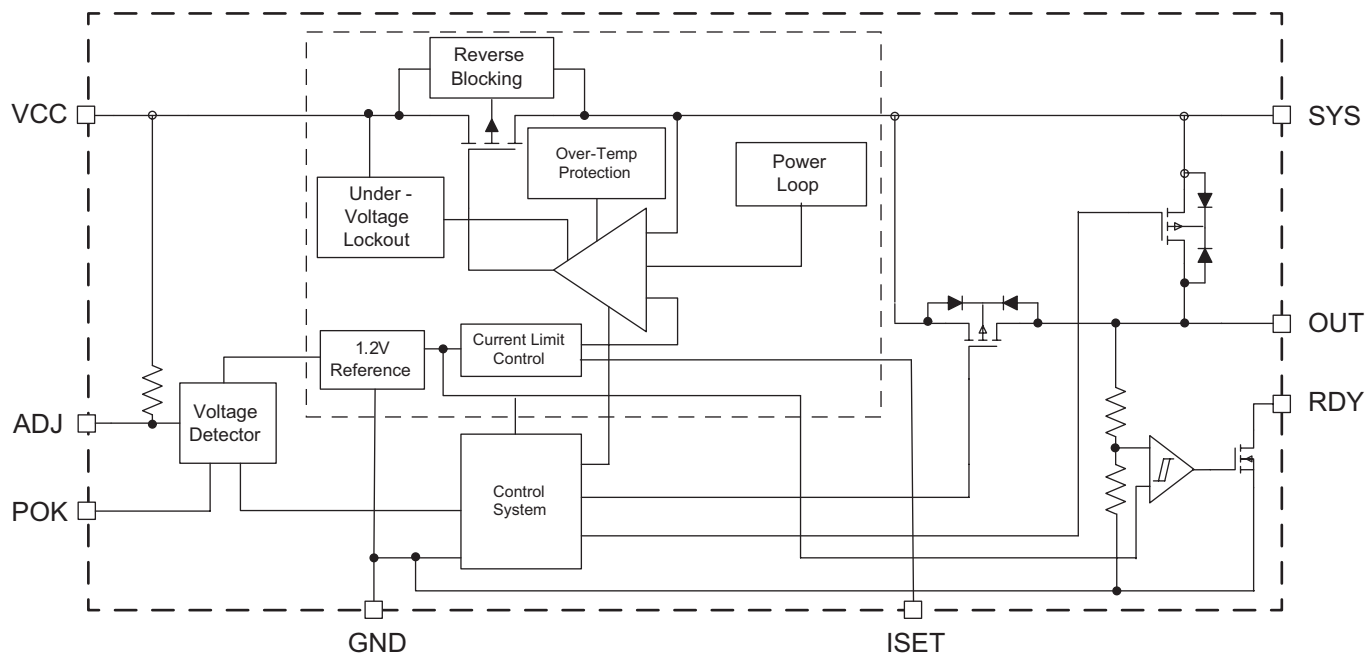
Power Path with Input Current Limit and Capacitor Charger**Functional Block Diagram****Functional Description**

The AAT4710 is an integrated P-channel MOSFET load switch with adjustable current limits, integrated discharge path, over temperature protection, a power loop and a super capacitor charger. The input current limit control is combined with an over-temperature thermal limit and power loop circuit to provide a comprehensive system to protect the load switch and its supply from load conditions exceeding the supply specifications. The AAT4710 integrates the discharge path for SYS (to system load) from the VCC input or OUT input (connected to supercap) determined by whether VCC is higher than the programmed threshold setting by ADJ through an external resistor.

The input current is limited and is programmed by an external resistor for both system load and supercapacitor charging; system load always has higher priority. The device decreases supercapacitor charging current to provide more current to system load when the system load increases and keeps the host power rating from exceeding the input current limit.

The integrated over-temperature circuits act independently of the input current limit. The device input current limit is activated when the output load current exceeds an internal threshold level. The input current limit threshold in each case is determined by external resistors connected between the ISET pin and ground. The minimum input current limit threshold is specified by $I_{LIM(MIN)}$. If the load condition maintains the device in current limit and the chip temperature reaches a critical point, then an internal power loop will reduce the current to a safe level.

VCC pin under-voltage lockout circuitry ensures that the VCC supply is high enough for correct operation of the IC. OUT pin under-voltage lockout circuitry ensures that the V_{OUT} supply is high enough for correct operation of the IC when no VCC input power or VCC below UVLO voltage. An integrated POK function is adopted to indicate the system input power good.

AAT4710

Power Path with Input Current Limit and Capacitor Charger

Setting the Input Current Limit

The AAT4710 current limit is set via the ISET resistor. The ISET node operates within a window of 0.6V to 1.2V for resistor values ranging from 93.75kΩ to 1.5MΩ. Resistor values outside this range are not recommended. The ISET source current varies with the resistor value as shown in Table 1.

$$V_{ISET} = R_{SET} \cdot I_{ISET} = 0.6V \text{ to } 1.2V$$

If the set pin is open circuit or allowed to exceed 2V, all power devices are disabled and the input is disconnected from the output.

SYS Load and Capacitor Charge

The input current limit is equal to the SYS current plus the OUT charging current. If the SYS current increases/decreases, the OUT charging current will automatically decrease/increase accordingly by the device control loop. For example, if the input current limit is programmed to 1A and the SYS load current is 0.5A, then the OUT charging current is 0.5A; if the SYS load current increases to 0.8A, the OUT current decreases to 0.2A accordingly; if the SYS load current decreases to 0.2A, the OUT current increases to 0.8A dynamically.

Discharge Path Control

When the input voltage drops below the power good detect threshold programmed by the external resistor from ADJ pin to GND and the OUT pin voltage is greater than the V_{UVLO_OUT} and SYS pin voltage, the AAT4710 turns on the OUT to SYS switch discharge path after 6μs (T_{SW}) response time, then turns off the path of VCC to the SYS P-channel load switch. The OUT to SYS switch remains continuously on until the OUT pin voltage falls below V_{UVLO_OUT} .

Power Loop

The AAT4710's power loop limits the load current if device power dissipation becomes excessive. The power loop decreases the load current gradually to 1/32 of the current limit set point when the die temperature exceeds 110°C. The load current then increases in increments of 1/32 of the current limit set point until the set current limit point is reached or the die temperature exceeds 110°C. Figures 1 and 2 show the the power loop function as the device temperature increases and decreases at a 1A current limit setting.

R_{SET} Range (Ω)	I_{ISET} (μA)	I_{LIM}/V_{ISET} (A/V)	Current Limit Range (A)	Current Limit
1.5Meg - 750k	0.8	1	1.2 - 0.6	$R_{SET} \times 0.8 \times 1$
750k - 375k	1.6	0.5	0.6 - 0.3	$R_{SET} \times 1.6 \times 0.5$
375k - 187.5k	3.2	0.25	0.3 - 0.15	$R_{SET} \times 3.2 \times 0.25$
187.5k - 93.75k	6.4	0.125	0.15 - 0.075	$R_{SET} \times 6.4 \times 0.125$

Table 1: R_{SET} Values for Setting the Input Current.

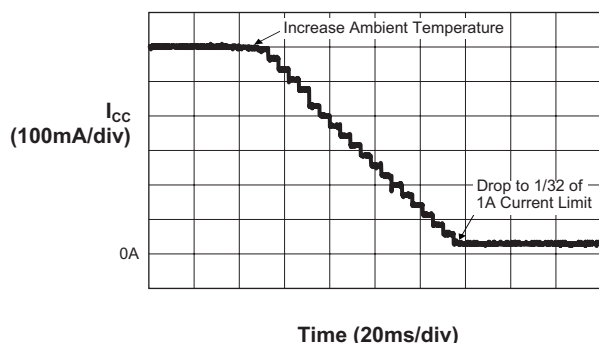

Figure 1: AAT4710 Power Loop Function at 1A

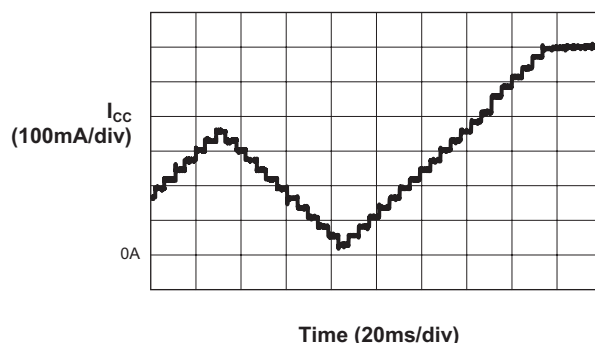

Figure 2: AAT4710 Power Loop Function at 1A

Power Path with Input Current Limit and Capacitor Charger

Current Limit with Ambient Temperature Increasing. Current Limit with Ambient Temperature Decreasing.

The delay time between die temperature measurements varies depending on the load current limit set point. The delay ranges from 0.5ms for a 75mA current limit set point to 4ms for a 1.2A current limit set point.

Over-Temperature Protection

If the die temperature rises quickly enough to exceed the power loop regulated temperature, over-temperature shutdown disables the device. The over-temperature threshold is 145°C. After over-temperature shutdown, soft start is initiated once the die temperature drops to 130°C.

Power OK Indicator (POK)

On initial power-up, if VCC is higher than the power good detect threshold programmed by the external resistor from the ADJ pin to GND, the POK signal switches from low to high after 2μs delay time (T_{DETECT}) to indicate input power good.

If VCC drops below the power good detect point, the POK signal switches from high to low after 2μs delay time (T_{DETECT}).

Capacitor Charge Ready Indicator (RDY)

The internal comparator senses the OUT voltage and delivers a high level as ready signal to the external microcontroller when the OUT voltage reaches 98% of the VCC voltage with fixed 200mV hysteresis.

The capacitor charge ready pin (RDY) is an open drain output. A external pull up resistor with a typical value of 100kΩ is required.

Application Information

Input Current Limit Setting

The input current limit is programmed by R_{SET} from ISET to ground in the range from 75mA to 1.2A. The current limit limits the maximum current of both VCC to SYS and VCC to OUT. The R_{SET} can be calculated by:

$$R_{SET} = \frac{I_{LIM}}{0.8} \text{ (Voltage in V, resistance in k}\Omega\text{)}$$

Table 2 lists some 1% standard metal film resistor values for current limit settings from 75mA to 1.2A.

R_{SET} (kΩ)	Current Limit (A)
1500	1.2
1240	1
1000	0.8
750	0.6
620	0.5
499	0.4
374	0.3
249	0.2
187	0.15
93.1	0.075

Table 2: Recommended Current Limit R_{SET} Values.

Power Good Detect Threshold Setting

The power good detect threshold (V_{POK_TH}) determines the point at which the discharge path changes from VCC – SYS to OUT – SYS if the OUT pin voltage is above V_{UVLO_OUT} and the SYS pin voltage. The power good detect threshold is programmed by the external resistor R_{ADJ} connected from the ADJ pin to GND. The R_{ADJ} value can be calculated by:

$$R_{ADJ} = \frac{60}{V_{POK_TH} - 1.2} \text{ (Voltage in V, resistance in k}\Omega\text{)}$$

Table 3 summarizes some 1% standard metal film resistor values for various V_{POK_TH} settings.

R_{ADJ} (kΩ)	V_{POK_TH} (V)
15.8	5.0
18.2	4.5
20.5	4.0
26.1	3.5
33.2	3.0
47	2.5

Table 3: Recommended Resistor Values for V_{POK_TH} Settings.

Power Path with Input Current Limit and Capacitor Charger

Discharge Path Control

As the AAT4710 powers the system load, the device automatically selects VCC or OUT as the power source. OUT is designed to connect a supercapacitor as a backup source. Figure 3 shows the discharge path control operation at 1A current limit setting. When VCC is powered on from zero to 5V, the SYS voltage also rises to 5V and 500mA current is passed through from VCC to SYS as system load. With the 1A current limit, the additional 500mA is used to charge the supercapacitor via IOUT as shown. After 3.5 seconds, the 550mF supercapacitor is fully charged; the charging current decreases to zero, and ICC current decreases to 500mA. When VCC drops from 5V to zero, the backup power source VOUT provides the 500mA load current to SYS until the supercapacitor voltage is discharged to below the UVLO voltage threshold (typ. 1.8V).

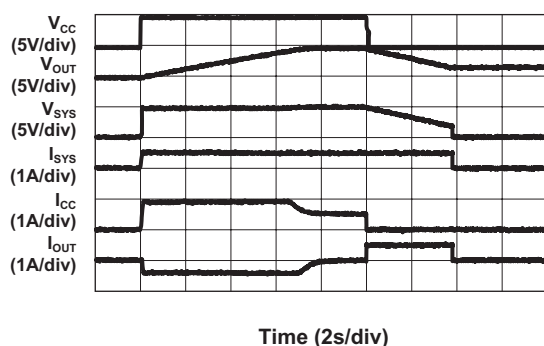

Figure 3: Discharge Path Control with 550mF Supercapacitor at 1A Current Limit Setting and 500mA System Load.

Reverse Blocking

The internal reverse blocking comparator disconnects the VCC to SYS path by turning off the power PMOSFETs when SYS is higher than VCC minus 18mV, preventing any reverse current from the system load to the input. With 22mV hysteresis, the VCC to SYS path will be reconnected by turning on the power PMOSFETs when the SYS voltage drops to VIN minus 40mV. The reverse blocking comparator has a typical 5 μ s delay time, which may lead to output voltage ripple on the SYS output at light load. Increasing the SYS output capacitor value can improve the output voltage ripple when the application has special SYS voltage ripple requirements.

Input Capacitor

A 10 μ F capacitor is typically recommended for C_{IN}. C_{IN} should be located as close to the device VCC pin as practically possible. Ceramic, tantalum, or aluminum electrolytic capacitors may be selected for C_{IN}. There is no specific capacitor equivalent series resistance (ESR) requirement for C_{IN}. However, for higher current operation, ceramic capacitors are recommended for C_{IN} due to their inherent capability over tantalum capacitors to withstand input current surges from low impedance sources.

System Output Capacitor

A small output capacitance of approximately 10 μ F is required at the system output. The output capacitor helps to filter the SYS voltage when the device works between reverse blocking and normal operation. For higher output voltage ripple requirements at light load (below 1/3 current limit), a greater output capacitor value is required.

OUT Supercapacitor

The AAT4710's OUT pin is designed to connect a supercapacitor to ground to give the system a backup when VCC experiences short power interrupts. A supercapacitor offers high capacitance in a small package; it adopts special electrodes and some electrolyte. Three types of electrode materials are suitable for the supercapacitor: high surface area activated carbons, metal oxide, and conducting polymers. The first option is the lowest cost to manufacture; the electrolyte usually is aqueous or organic. An aqueous electrolyte offers low internal resistance but limits the voltage to 1V; the organic allows 2.5V of charge but has higher internal resistance. For higher voltage applications, supercapacitors are connected in series. To prevent any cell from charging over-voltage, a balance resistor is required on a string of more than three cells.

Three parameters should be considered when selecting a supercapacitor. These parameters are capacitance, rated voltage, and ESR. Table 4 shows some recommended supercapacitors. Other parameters such as temperature range, RMS current, leakage current, etc. should also be considered during the system design.

AAT4710

Power Path with Input Current Limit and Capacitor Charger

SYS Short Circuit Protection

The series pass power MOSFET from VCC to SYS limits the current to a low level after the SYS output shorts to ground to protect the device and downstream components. During the fault condition, the power loop is still active to monitor the die temperature and reduce the current when the die temperature exceeds 110°C. Once the short-circuit fault is removed, the SYS voltage recovers to the normal value automatically.

The AAT4710 also includes short-circuit protection circuitry for the discharge path from OUT to SYS to avoid large current discharging through the device over a long term and avoid damage to the device.

PCB Layout Recommendations

For proper thermal management and to take advantage of the low $R_{DS(ON)}$ of the AAT4710, certain circuit board layout rules should be followed:

1. V_{CCr} , V_{OUTr} and V_{SYS} should be routed using wide traces.
2. GND should be connected to a ground plane. The ground plane area connected to the ground pins should be made as large as possible.
3. For best performance, C_{IN} and C_{SYS} should be placed close to the VCC and SYS pins.
4. For maximum power dissipation of the AAT4710 TDFN package, the exposed pad should be soldered to the board ground plane to further increase local heat dissipation. A ground pad below the exposed pad is strongly recommended.

Manufacturer	Part Number	Capacitance (mF)	Rated Voltage (V)	ESR (mΩ)	Size L x W x H (mm)
Cap-xx	HS 203F	250	5.5	70	39 x 17 x 2.15
	HS 211F	370	5.5	55	39 x 17 x 2.9
	HS 206F	600	5.5	70	39 x 17 x 2.4
	HW 207F	450	5.5	100	28.5 x 17 x 2.9
TDK	EDLC152344-551-2F-30	550	5.5	30	44 x 23 x 1.5
	EDLC262020-501-2F-50	500	5.5	50	20 x 20 x 2.6

Table 4: Recommended Supercapacitors

Evaluation Board Schematic

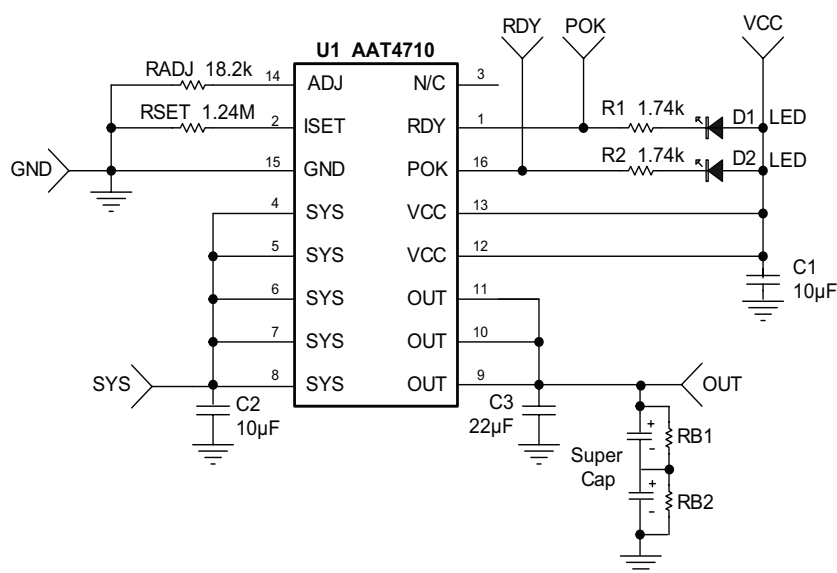
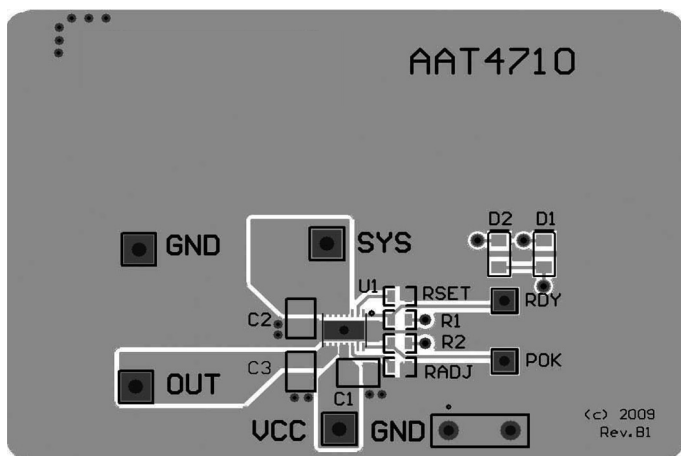

Figure 4: AAT4710 Evaluation Board Schematic.

AAT4710

Power Path with Input Current Limit and Capacitor Charger

Evaluation Board Layout



a: Top Side

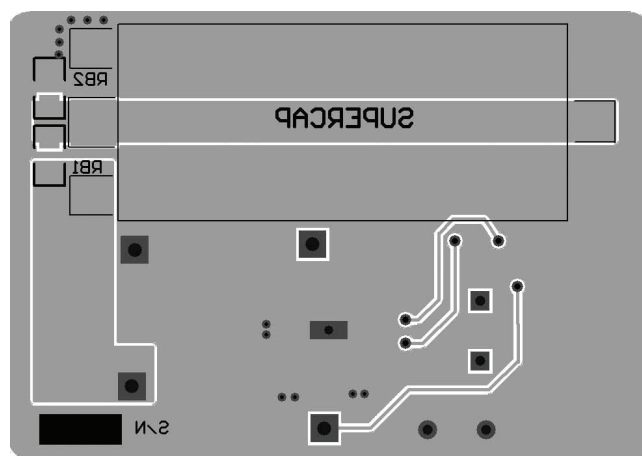

b: Bottom Side

Figure 5: AAT4710 Evaluation Board Layout.

Component	Part Number	Description	Manufacturer
U1	AAT4710	Current Limited Switch with Capacitor Charger	Skyworks
R1,R2	RC0603FR-071K74L	Res 1.74K Ω 1/10W 1% 0603 SMD	Yageo
R _{SET}	RC0603FR-071M24L	Res 1.24M Ω 1/10W 1% 0603 SMD	
R _{ADJ}	RC0603FR-0718K2L	Res 18.2K Ω 1/10W 1% 0603 SMD	
C1, C2	GRM21BR61C106K	Cap Ceramic 10 μ F 0805 X5R 16V 10%	Murata
C3	GRM21BR60J226M	Cap Ceramic 22 μ F 0805 X5R 6.3V 20%	
D1, D2	0805KRCT	Red LED 0805	HB
SUPERCAP, RB1, RB2	Not populated		

Table 5: AAT4710 Evaluation Board Bill of Materials.

AAT4710

Power Path with Input Current Limit and Capacitor Charger

Ordering Information

Package	Marking ¹	Part Number (Tape and Reel) ²
TDFN34-16	9HXY	AAT4710IRN-T1



Skyworks Green™ products are compliant with all applicable legislation and are halogen-free.

For additional information, refer to *Skyworks Definition of Green™*, document number SQ04-0074.

Package Information³

TDFN34-16

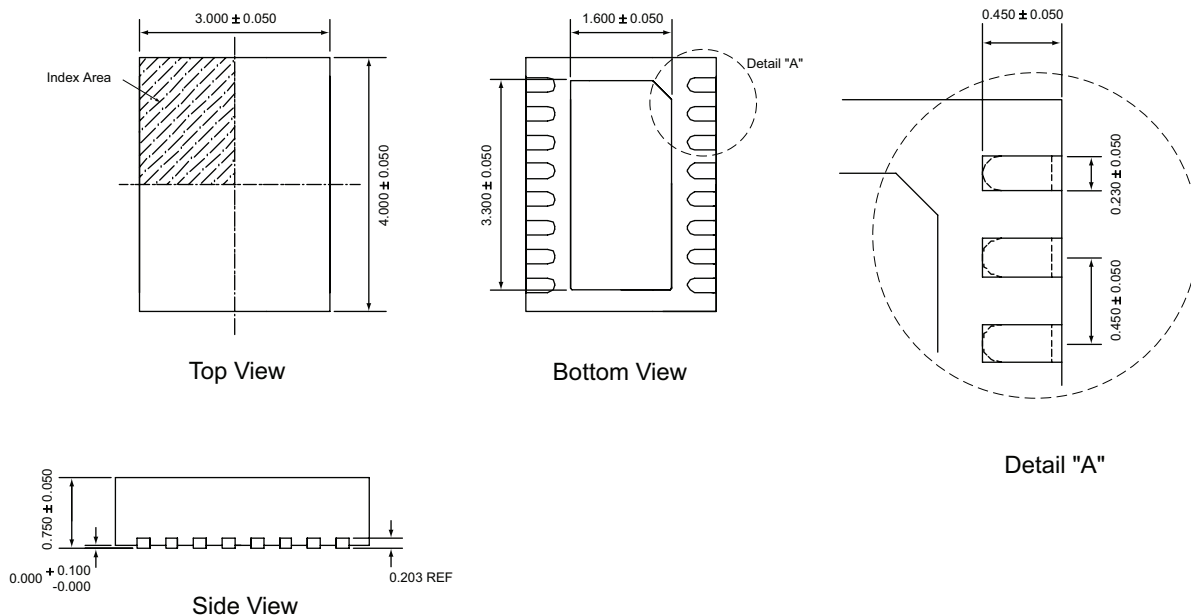

All dimensions in millimeters.

1. XYY = assembly and date code.
2. Sample stock is generally held on part numbers listed in **BOLD**.
3. The leadless package family, which includes QFN, TQFN, DFN, TDFN and STDFN, has exposed copper (unplated) at the end of the lead terminals due to the manufacturing process. A solder fillet at the exposed copper edge cannot be guaranteed and is not required to ensure a proper bottom solder connection.

Power Path with Input Current Limit and Capacitor Charger

Copyright © 2012 Skyworks Solutions, Inc. All Rights Reserved.

Information in this document is provided in connection with Skyworks Solutions, Inc. ("Skyworks") products or services. These materials, including the information contained herein, are provided by Skyworks as a service to its customers and may be used for informational purposes only by the customer. Skyworks assumes no responsibility for errors or omissions in these materials or the information contained herein. Skyworks may change its documentation, products, services, specifications or product descriptions at any time, without notice. Skyworks makes no commitment to update the materials or information and shall have no responsibility whatsoever for conflicts, incompatibilities, or other difficulties arising from any future changes.

No license, whether express, implied, by estoppel or otherwise, is granted to any intellectual property rights by this document. Skyworks assumes no liability for any materials, products or information provided hereunder, including the sale, distribution, reproduction or use of Skyworks products, information or materials, except as may be provided in Skyworks Terms and Conditions of Sale.

THE MATERIALS, PRODUCTS AND INFORMATION ARE PROVIDED "AS IS" WITHOUT WARRANTY OF ANY KIND, WHETHER EXPRESS, IMPLIED, STATUTORY, OR OTHERWISE, INCLUDING FITNESS FOR A PARTICULAR PURPOSE OR USE, MERCHANTABILITY, PERFORMANCE, QUALITY OR NON-INFRINGEMENT OF ANY INTELLECTUAL PROPERTY RIGHT; ALL SUCH WARRANTIES ARE HEREBY EXPRESSLY DISCLAIMED. SKYWORKS DOES NOT WARRANT THE ACCURACY OR COMPLETENESS OF THE INFORMATION, TEXT, GRAPHICS OR OTHER ITEMS CONTAINED WITHIN THESE MATERIALS. SKYWORKS SHALL NOT BE LIABLE FOR ANY DAMAGES, INCLUDING BUT NOT LIMITED TO ANY SPECIAL, INDIRECT, INCIDENTAL, STATUTORY, OR CONSEQUENTIAL DAMAGES, INCLUDING WITHOUT LIMITATION, LOST REVENUES OR LOST PROFITS THAT MAY RESULT FROM THE USE OF THE MATERIALS OR INFORMATION, WHETHER OR NOT THE RECIPIENT OF MATERIALS HAS BEEN ADVISED OF THE POSSIBILITY OF SUCH DAMAGE.

Skyworks products are not intended for use in medical, lifesaving or life-sustaining applications, or other equipment in which the failure of the Skyworks products could lead to personal injury, death, physical or environmental damage. Skyworks customers using or selling Skyworks products for use in such applications do so at their own risk and agree to fully indemnify Skyworks for any damages resulting from such improper use or sale.

Customers are responsible for their products and applications using Skyworks products, which may deviate from published specifications as a result of design defects, errors, or operation of products outside of published parameters or design specifications. Customers should include design and operating safeguards to minimize these and other risks. Skyworks assumes no liability for applications assistance, customer product design, or damage to any equipment resulting from the use of Skyworks products outside of stated published specifications or parameters.

Skyworks, the Skyworks symbol, and "Breakthrough Simplicity" are trademarks or registered trademarks of Skyworks Solutions, Inc., in the United States and other countries. Third-party brands and names are for identification purposes only, and are the property of their respective owners. Additional information, including relevant terms and conditions, posted at www.skyworksinc.com, are incorporated by reference.

Компания «Океан Электроники» предлагает заключение долгосрочных отношений при поставках импортных электронных компонентов на взаимовыгодных условиях!

Наши преимущества:

- Поставка оригинальных импортных электронных компонентов напрямую с производств Америки, Европы и Азии, а так же с крупнейших складов мира;
- Широкая линейка поставок активных и пассивных импортных электронных компонентов (более 30 млн. наименований);
- Поставка сложных, дефицитных, либо снятых с производства позиций;
- Оперативные сроки поставки под заказ (от 5 рабочих дней);
- Экспресс доставка в любую точку России;
- Помощь Конструкторского Отдела и консультации квалифицированных инженеров;
- Техническая поддержка проекта, помощь в подборе аналогов, поставка прототипов;
- Поставка электронных компонентов под контролем ВП;
- Система менеджмента качества сертифицирована по Международному стандарту ISO 9001;
- При необходимости вся продукция военного и аэрокосмического назначения проходит испытания и сертификацию в лаборатории (по согласованию с заказчиком);
- Поставка специализированных компонентов военного и аэрокосмического уровня качества (Xilinx, Altera, Analog Devices, Intersil, Interpoint, Microsemi, Actel, Aeroflex, Peregrine, VPT, Syfer, Eurofarad, Texas Instruments, MS Kennedy, Miteq, Cobham, E2V, MA-COM, Hittite, Mini-Circuits, General Dynamics и др.);

Компания «Океан Электроники» является официальным дистрибьютором и эксклюзивным представителем в России одного из крупнейших производителей разъемов военного и аэрокосмического назначения «JONHON», а так же официальным дистрибьютором и эксклюзивным представителем в России производителя высокотехнологичных и надежных решений для передачи СВЧ сигналов «FORSTAR».



JONHON

«JONHON» (основан в 1970 г.)

Разъемы специального, военного и аэрокосмического назначения:

(Применяются в военной, авиационной, аэрокосмической, морской, железнодорожной, горно- и нефтедобывающей отраслях промышленности)

«FORSTAR» (основан в 1998 г.)

ВЧ соединители, коаксиальные кабели, кабельные сборки и микроволновые компоненты:

(Применяются в телекоммуникациях гражданского и специального назначения, в средствах связи, РЛС, а так же военной, авиационной и аэрокосмической отраслях промышленности).



Телефон: 8 (812) 309-75-97 (многоканальный)

Факс: 8 (812) 320-03-32

Электронная почта: ocean@oceanchips.ru

Web: <http://oceanchips.ru/>

Адрес: 198099, г. Санкт-Петербург, ул. Калинина, д. 2, корп. 4, лит. А