

# TPD1038F

## Motor, Solenoid, Lamp Drivers

### High-side Power Switch

The TPD1038F is a monolithic power IC for high-side switches. The IC has a vertical MOS FET output which can be directly driven from a CMOS or TTL logic circuit (e.g., an MPU). The device offers intelligent self-protection and diagnostic functions.

### Features

- A monolithic power IC with a structure combining a control block (Bi-CMOS) and a vertical power MOS FET on a single chip.
- One side of load can be grounded to a high-side switch.
- Can directly drive a power load from a microprocessor.
- Built-in protection against overheating and load short-circuiting.
- Incorporates a diagnosis function that allows diagnosis output to be read externally at load short-circuiting, opening, or overheating.
- Up to  $-(50-V_{DD}) \sim -(60-V_{DD})$  of counterelectromotive force from an L load can be applied.
- Low on-resistance :  $R_{DS(ON)}=120m\Omega$  (max) (@  $V_{DD} = 12 V$ ,  $T_a = 25^\circ C$ ,  $I_o = 2 A$ )
- 8-pin SOP package for surface mounting that can be packed in tape

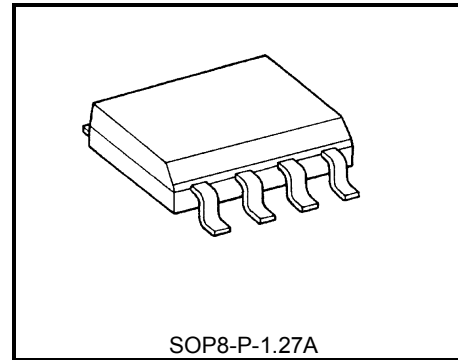

Weight : 0.08g(typ.)

### Pin Assignment

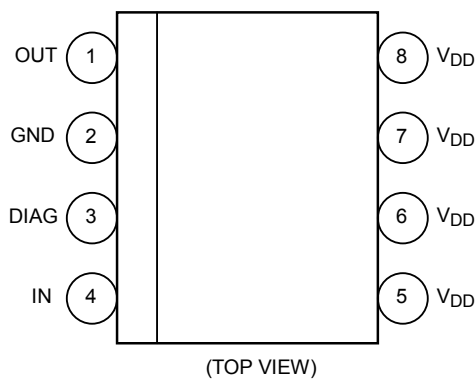

### Marking

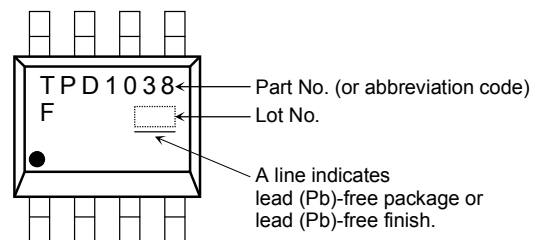

Due to its MOS structure, this product is sensitive to static electricity.

**Block Diagram**

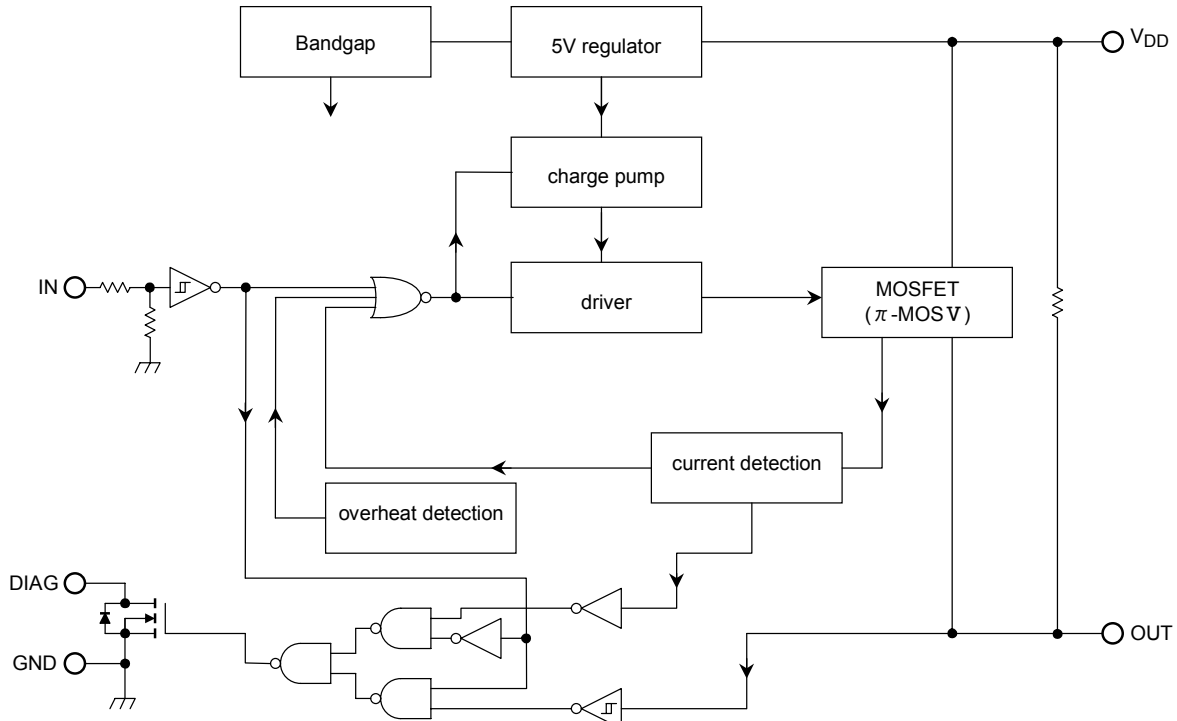

**Pin Description**

Pin No.	Symbol	Function
1	OUT	Output pin. When the load is short-circuited and current in excess of the detection current (3A min) flows to the output pin, the output automatically turns on or off.
2	GND	Ground pin.
3	DIAG	Self-diagnosis detection pin. Goes low when overheating is detected or when output is short circuit with input on (high). N-channel open drain.
4	IN	Input pin. Input is CMOS compatible, with pull down resistor connected. Even if the input is open, output will not accidentally turn on.
5,6,7,8	V <sub>DD</sub>	Power pin.

**Timing Chart**

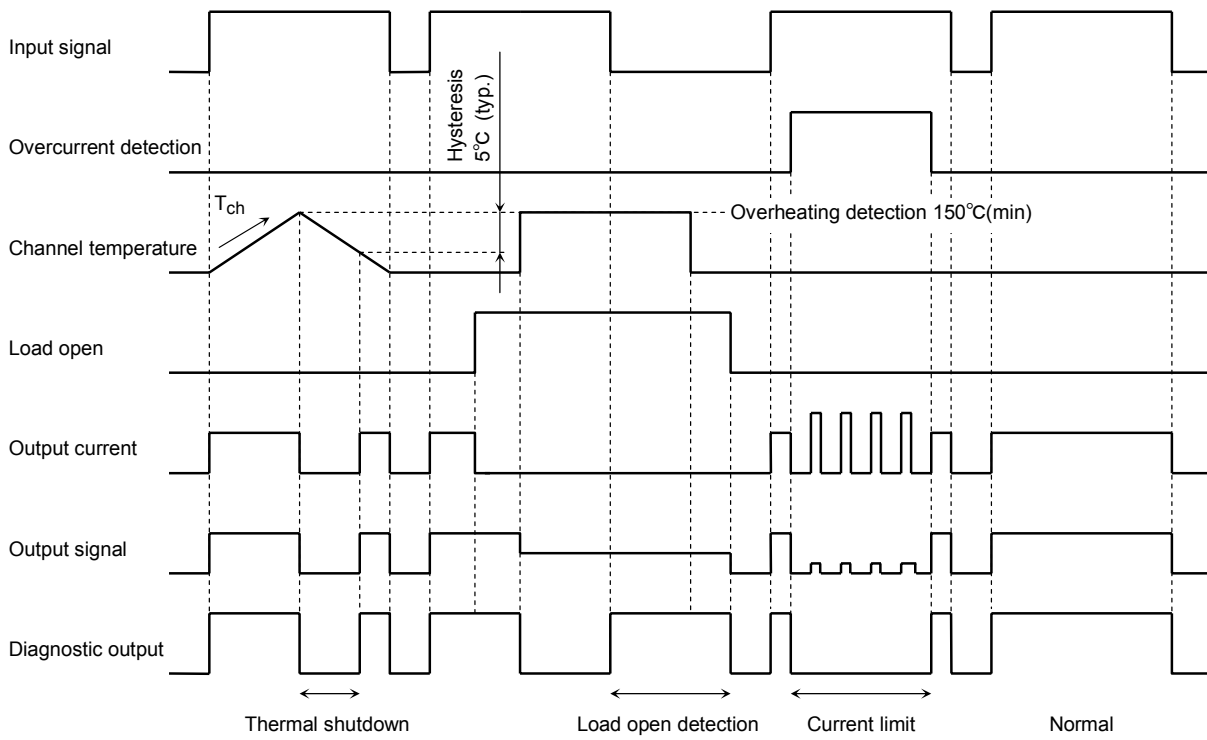

**Truth Table**

Input signal	Diagnosis output	Output signal	Output state	Operating state
H	H	H	on	Normal
L	L	L	off	
H	L	L	current limit (switching)	Load short
L	L	L	off	
H	L	L	off	Overheating
L	L	L	off	
H	H	H	on	Load open
L	H	H	off	
H	L	L	off	Overheating and load open
L	H	H	off	

## Absolute Maximum Ratings (Ta = 25°C)

Characteristics	Symbol	Rating	Unit
Drain-source voltage	V <sub>DS</sub>	60	V
Supply voltage	DC	V <sub>DD(1)</sub>	25
	Pulse	V <sub>DD(2)</sub>	60(R <sub>S</sub> =1Ω, τ=250ms)
Input voltage	DC	V <sub>IN(1)</sub>	-0.5~12
	Pulse	V <sub>IN(2)</sub>	V <sub>DD(1)</sub> +1.5(t=100ms)
Diagnosis output voltage	V <sub>DIAG</sub>	-0.5~25	V
Output current	I <sub>O</sub>	Internally limited	A
Input current	I <sub>IN</sub>	±10	mA
Diagnosis current	I <sub>DIAG</sub>	5	mA
Power dissipation (Note 1-a)	P <sub>D(1)</sub>	1.1	W
Power dissipation (Note 1-b)	P <sub>D(2)</sub>	0.425	W
Operating temperature	T <sub>opr</sub>	-40~110	°C
Channel temperature	T <sub>ch</sub>	150	°C
Storage temperature	T <sub>stg</sub>	-55~150	°C

Note: Using continuously under heavy loads (e.g. the application of high temperature/current/voltage and the significant change in temperature, etc.) may cause this product to decrease in the reliability significantly even if the operating conditions (i.e. operating temperature/current/voltage, etc.) are within the absolute maximum ratings and the operating ranges.

Please design the appropriate reliability upon reviewing the Toshiba Semiconductor Reliability Handbook ("Handling Precautions"/Derating Concept and Methods) and individual reliability data (i.e. reliability test report and estimated failure rate, etc).

## Thermal Resistance

Characteristic	Symbol	Rating	Unit
Thermal resistance	R <sub>th(ch-a)</sub>	113.5 (Note1-a)	°C /W
		294.0 (Note1-b)	

Note 1:

1-a : Mounted on glass epoxy board (a)

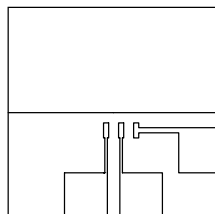

FR-4  
25.4 × 25.4 × 0.8  
(Unit : mm)

1-b : Mounted on glass epoxy board (b)

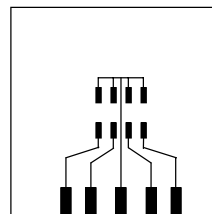

FR-4  
25.4 × 25.4 × 0.8  
(Unit : mm)

## Electrical Characteristics (T<sub>a</sub>=25°C)

Characteristics	Symbol	Test circuit	Test condition	min	typ.	max	Unit
Operating supply voltage	V <sub>DD(OPR)</sub>	—	—	6	12	18	V
Current dissipation	I <sub>DD</sub>	—	V <sub>DD</sub> =12V, V <sub>IN</sub> =0V, R <sub>L</sub> =10Ω	—	—	3	mA
H-level input voltage	V <sub>IH</sub>	—	V <sub>DD</sub> =12V	3.5	—	—	V
L-level input voltage	V <sub>IL</sub>	—	V <sub>DD</sub> =12V	—	—	1.5	V
H-level input current	I <sub>IH</sub>	—	V <sub>DD</sub> =12V, V <sub>IN</sub> =5V	—	—	200	μA
On resistance	R <sub>D(S)ON</sub>	—	V <sub>DD</sub> =12V, I <sub>O</sub> =2A	—	—	0.12	Ω
Output leakage current	I <sub>OL</sub>	—	V <sub>DD</sub> =12V	—	—	1	mA
Diagnosis output voltage	V <sub>DL</sub>	—	V <sub>DD</sub> =12V, V <sub>IN</sub> =0V, I <sub>DL</sub> =1mA, R <sub>L</sub> =10Ω	—	—	0.4	V
Diagnosis output current	I <sub>DH</sub>	—	V <sub>DD</sub> =12V, V <sub>IN</sub> =5V, R <sub>L</sub> =10Ω, V <sub>DH</sub> =12V	—	—	10	μA
Over current detection	I <sub>OC(1)</sub> (Note2)	1, 2	V <sub>DD</sub> =12V	3	—	9	A
	I <sub>OC(2)</sub> (Note3)	3	V <sub>DD</sub> =12V, R <sub>L</sub> =0.1Ω	—	—	10	A
Overheating detection	T <sub>OT</sub>	—	V <sub>DD</sub> =12V	150	—	200	°C
Load open detection (Note4)	R <sub>op</sub>	—	V <sub>DD</sub> =12V, V <sub>IN</sub> =0V	5	17	—	kΩ
Switching time	t <sub>on</sub>	4	V <sub>DD</sub> =12V, R <sub>L</sub> =10Ω	—	—	100	μs
	t <sub>off</sub>			—	—	40	μs
Diagnosis delay time	t <sub>DLH</sub>	5	V <sub>DD</sub> =12V, R <sub>L</sub> =10Ω	—	70	—	μs
	t <sub>DHL</sub>			—	22	—	μs
Output clamp voltage	V <sub>clamp</sub>	—	V <sub>DD</sub> =12V, V <sub>IN</sub> =0V, I <sub>O</sub> =1A, L=10mH	-(60-V <sub>DD</sub> )	—	-(50-V <sub>DD</sub> )	V

(Note 2) Over-current detection

(Note 3) Peak current @ current limit function

(Note 4) Load open detection function : V<sub>DD</sub> = 8 ~ 18V

### Test Circuit 1

Over current detection I<sub>OC(1)</sub> : Over current detection when load current is increased while V<sub>IN</sub> = "H"

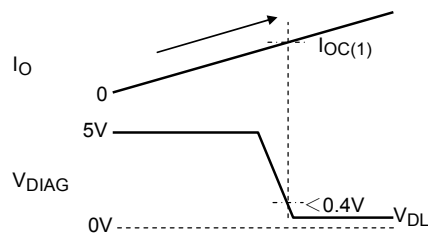
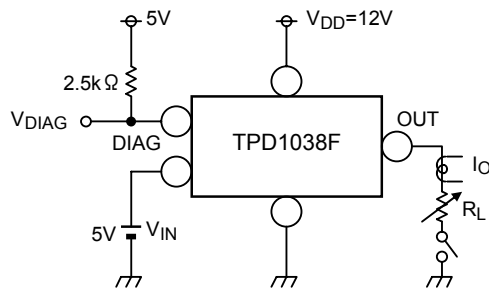

## Test Circuit 2

Over current detection  $I_{OC(1)}$  : Over current detection when load is short circuit and  $V_{IN} = "L" \rightarrow "H"$

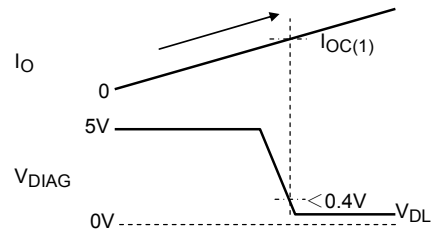
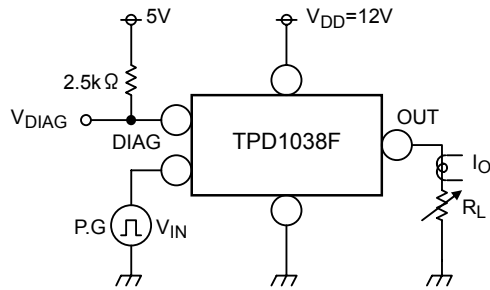

## Test Circuit 3

Over current detection  $I_{OC(2)}$

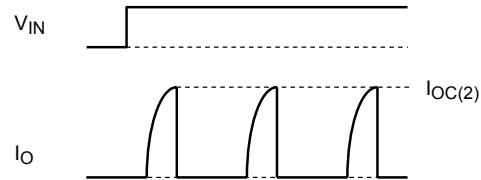
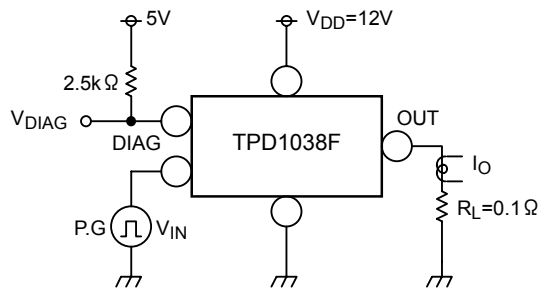

## Test Circuit 4

Switching time  $t_{on}$ ,  $t_{off}$

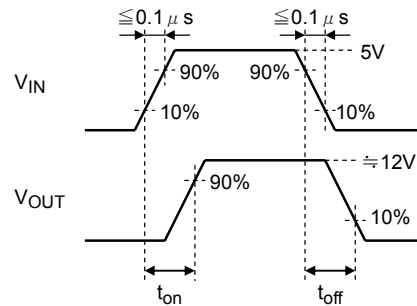
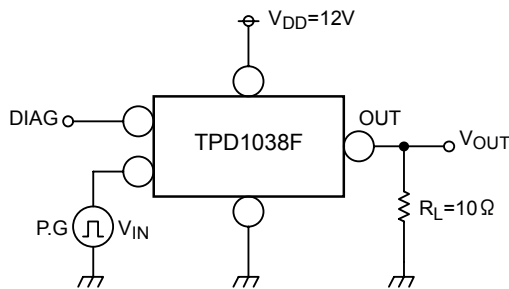

## Test Circuit 5

Diagnosis delay time  $t_{DLH}$ ,  $t_{DHL}$

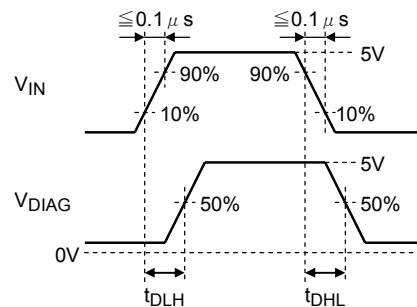
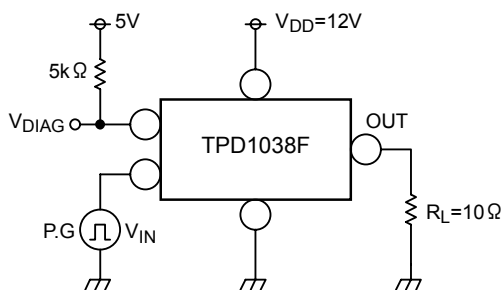

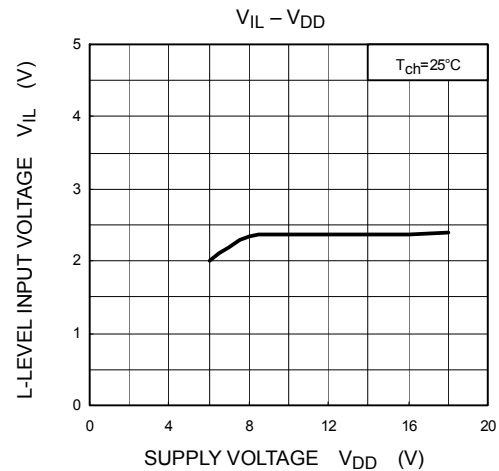
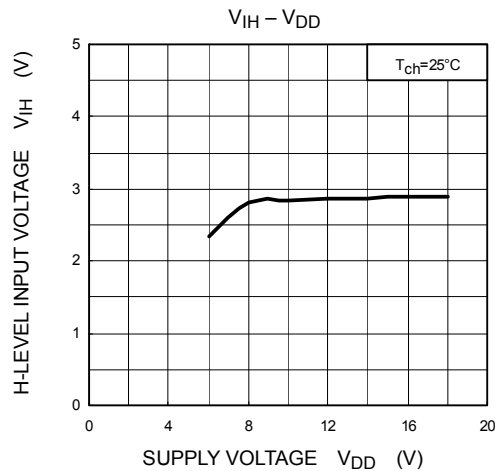
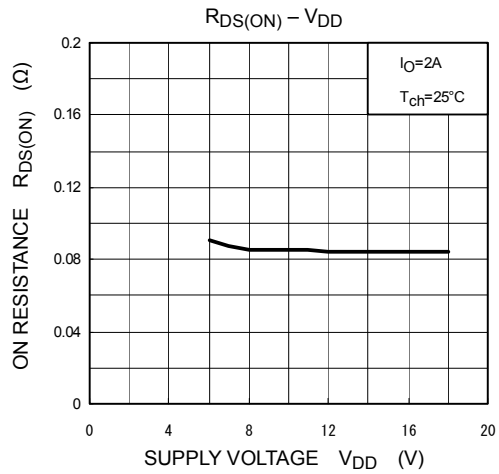
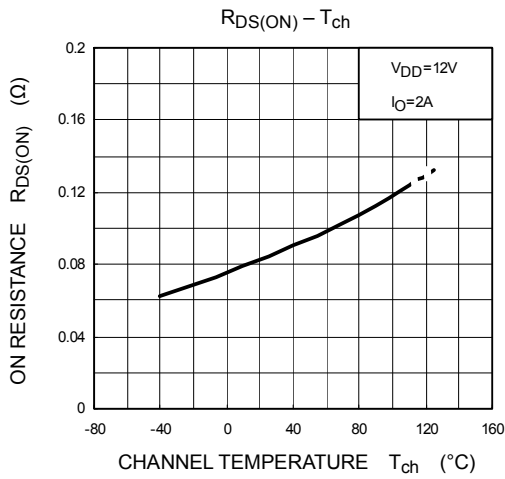
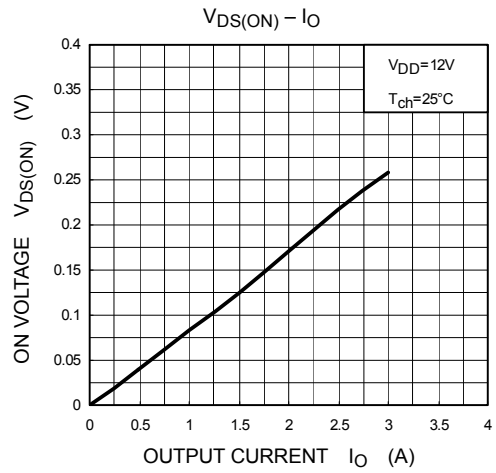
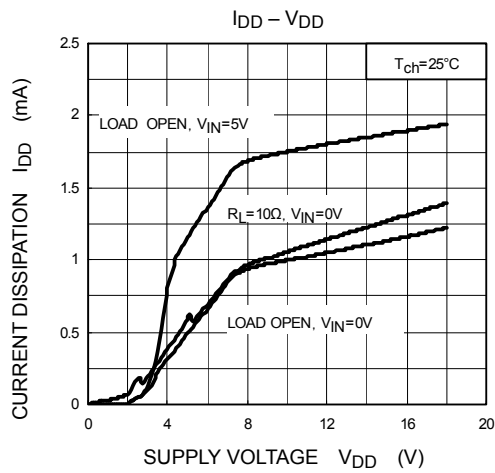

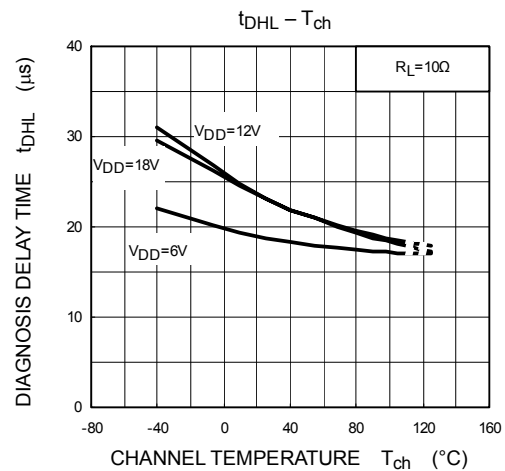
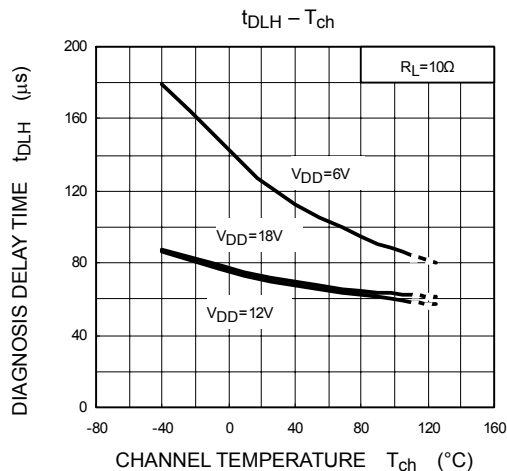
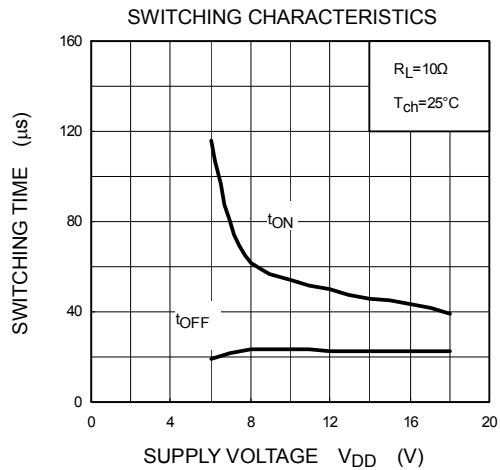
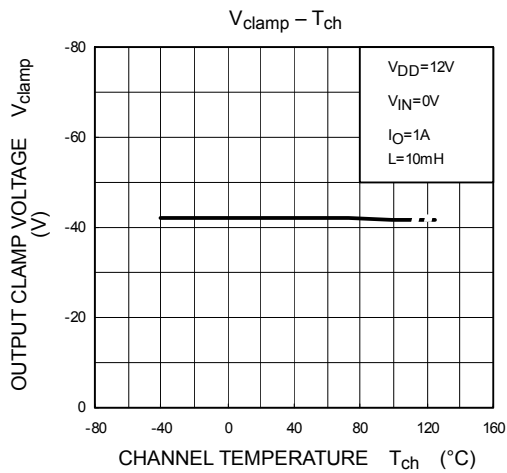
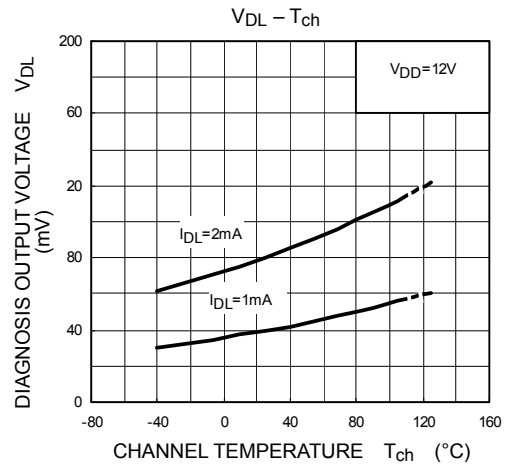
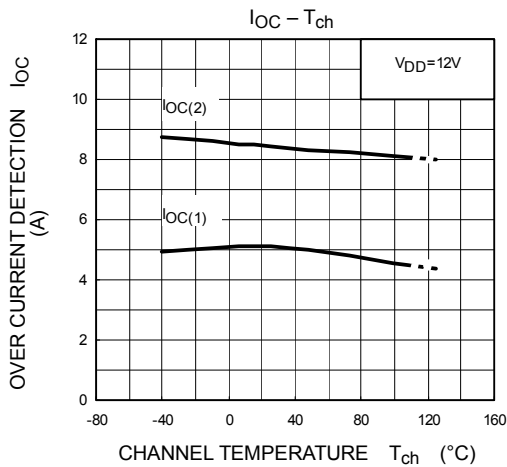



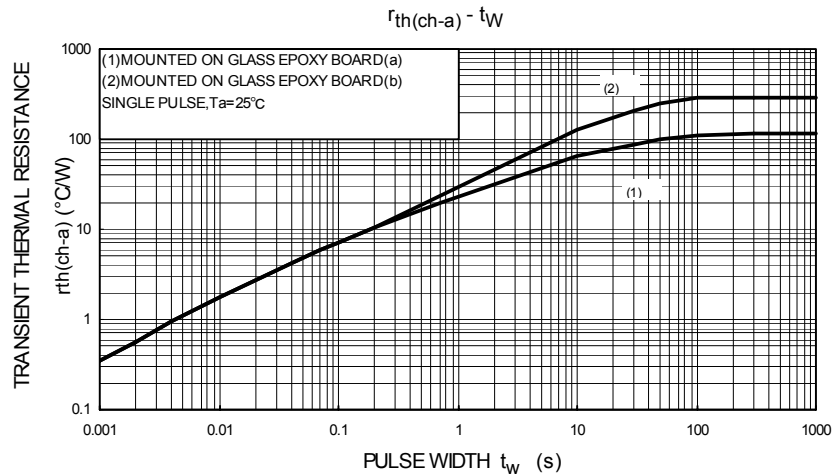
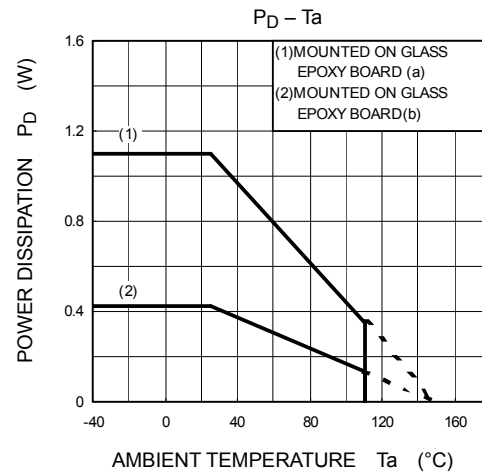
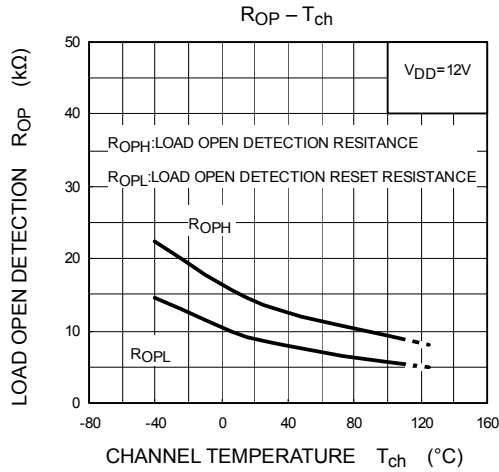
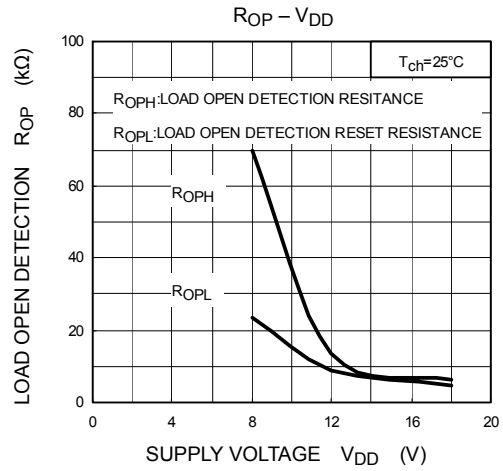
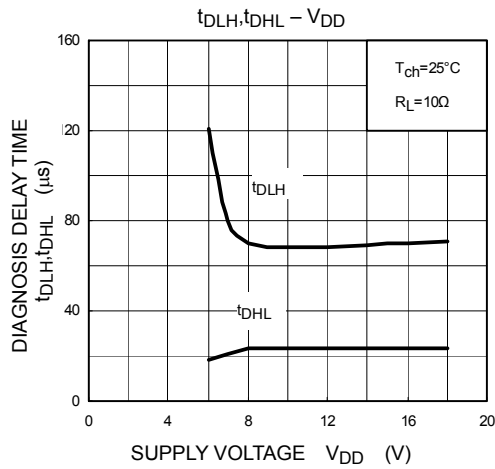

## Package Dimensions

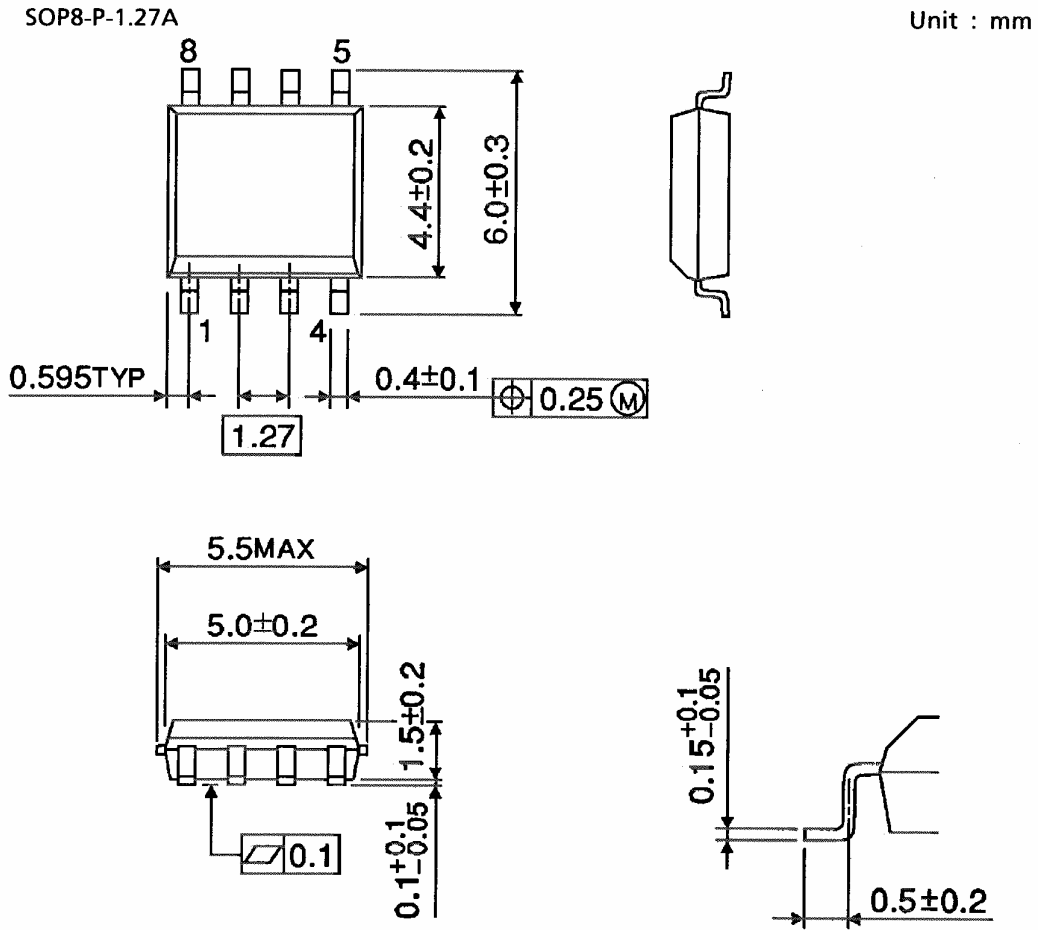

Weight: 0.08g (typ.)

**RESTRICTIONS ON PRODUCT USE**

030619EBA

- The information contained herein is subject to change without notice.
- The information contained herein is presented only as a guide for the applications of our products. No responsibility is assumed by TOSHIBA for any infringements of patents or other rights of the third parties which may result from its use. No license is granted by implication or otherwise under any patent or patent rights of TOSHIBA or others.
- TOSHIBA is continually working to improve the quality and reliability of its products. Nevertheless, semiconductor devices in general can malfunction or fail due to their inherent electrical sensitivity and vulnerability to physical stress. It is the responsibility of the buyer, when utilizing TOSHIBA products, to comply with the standards of safety in making a safe design for the entire system, and to avoid situations in which a malfunction or failure of such TOSHIBA products could cause loss of human life, bodily injury or damage to property.  
In developing your designs, please ensure that TOSHIBA products are used within specified operating ranges as set forth in the most recent TOSHIBA products specifications. Also, please keep in mind the precautions and conditions set forth in the "Handling Guide for Semiconductor Devices," or "TOSHIBA Semiconductor Reliability Handbook" etc..
- The TOSHIBA products listed in this document are intended for usage in general electronics applications (computer, personal equipment, office equipment, measuring equipment, industrial robotics, domestic appliances, etc.). These TOSHIBA products are neither intended nor warranted for usage in equipment that requires extraordinarily high quality and/or reliability or a malfunction or failure of which may cause loss of human life or bodily injury ("Unintended Usage"). Unintended Usage include atomic energy control instruments, airplane or spaceship instruments, transportation instruments, traffic signal instruments, combustion control instruments, medical instruments, all types of safety devices, etc.. Unintended Usage of TOSHIBA products listed in this document shall be made at the customer's own risk.
- The products described in this document are subject to the foreign exchange and foreign trade laws.

Компания «Океан Электроники» предлагает заключение долгосрочных отношений при поставках импортных электронных компонентов на взаимовыгодных условиях!

Наши преимущества:

- Поставка оригинальных импортных электронных компонентов напрямую с производств Америки, Европы и Азии, а так же с крупнейших складов мира;
- Широкая линейка поставок активных и пассивных импортных электронных компонентов (более 30 млн. наименований);
- Поставка сложных, дефицитных, либо снятых с производства позиций;
- Оперативные сроки поставки под заказ (от 5 рабочих дней);
- Экспресс доставка в любую точку России;
- Помощь Конструкторского Отдела и консультации квалифицированных инженеров;
- Техническая поддержка проекта, помощь в подборе аналогов, поставка прототипов;
- Поставка электронных компонентов под контролем ВП;
- Система менеджмента качества сертифицирована по Международному стандарту ISO 9001;
- При необходимости вся продукция военного и аэрокосмического назначения проходит испытания и сертификацию в лаборатории (по согласованию с заказчиком);
- Поставка специализированных компонентов военного и аэрокосмического уровня качества (Xilinx, Altera, Analog Devices, Intersil, Interpoint, Microsemi, Actel, Aeroflex, Peregrine, VPT, Syfer, Eurofarad, Texas Instruments, MS Kennedy, Miteq, Cobham, E2V, MA-COM, Hittite, Mini-Circuits, General Dynamics и др.);

Компания «Океан Электроники» является официальным дистрибьютором и эксклюзивным представителем в России одного из крупнейших производителей разъемов военного и аэрокосмического назначения «JONHON», а так же официальным дистрибьютором и эксклюзивным представителем в России производителя высокотехнологичных и надежных решений для передачи СВЧ сигналов «FORSTAR».



## JONHON

«JONHON» (основан в 1970 г.)

Разъемы специального, военного и аэрокосмического назначения:

(Применяются в военной, авиационной, аэрокосмической, морской, железнодорожной, горно- и нефтедобывающей отраслях промышленности)

«FORSTAR» (основан в 1998 г.)

ВЧ соединители, коаксиальные кабели,  
кабельные сборки и микроволновые компоненты:

(Применяются в телекоммуникациях гражданского и специального назначения, в средствах связи, РЛС, а так же военной, авиационной и аэрокосмической отраслях промышленности).



Телефон: 8 (812) 309-75-97 (многоканальный)

Факс: 8 (812) 320-03-32

Электронная почта: [ocean@oceanchips.ru](mailto:ocean@oceanchips.ru)

Web: <http://oceanchips.ru/>

Адрес: 198099, г. Санкт-Петербург, ул. Калинина, д. 2, корп. 4, лит. А