



# RF Power GaN Transistor

This 32 W RF power GaN transistor is designed for cellular base station applications covering the frequency range of 3400 to 3600 MHz.

This part is characterized and performance is guaranteed for applications operating in the 3400 to 3600 MHz band. There is no guarantee of performance when this part is used in applications designed outside of these frequencies.

### 3500 MHz

- Typical Single-Carrier W-CDMA Performance:  $V_{DD} = 48$  Vdc,  $I_{DQ} = 190$  mA,  $P_{out} = 32$  W Avg., Input Signal PAR = 9.9 dB @ 0.01% Probability on CCDF.

Frequency	$G_{ps}$ (dB)	$\eta_D$ (%)	Output PAR (dB)	ACPR (dBc)	IRL (dB)
3400 MHz	15.6	37.2	7.0	-33.6	-16
3500 MHz	15.7	36.7	7.2	-34.1	-16
3600 MHz	15.9	38.9	7.2	-33.2	-13

### Features

- High Terminal Impedances for Optimal Broadband Performance
- Designed for Digital Predistortion Error Correction Systems
- Optimized for Doherty Applications

**A2G35S160-01SR3**

**3400–3600 MHz, 32 W AVG., 48 V  
 AIRFAST RF POWER GaN  
 TRANSISTOR**

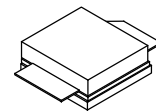

**NI-400S-2S**

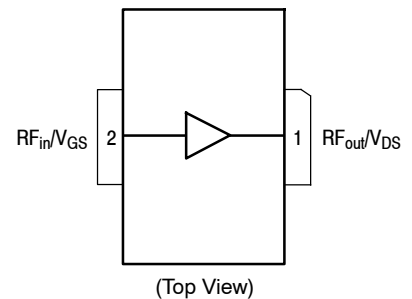

**Figure 1. Pin Connections**



**Table 1. Maximum Ratings**

Rating	Symbol	Value	Unit
Drain-Source Voltage	$V_{DSS}$	125	Vdc
Gate-Source Voltage	$V_{GS}$	-8, 0	Vdc
Operating Voltage	$V_{DD}$	0 to +55	Vdc
Maximum Forward Gate Current @ $T_C = 25^\circ\text{C}$	$I_{GMAX}$	19	mA
Storage Temperature Range	$T_{stg}$	-65 to +150	$^\circ\text{C}$
Case Operating Temperature Range	$T_C$	-55 to +150	$^\circ\text{C}$
Operating Junction Temperature Range	$T_J$	-55 to +225	$^\circ\text{C}$
Absolute Maximum Junction Temperature (1)	$T_{MAX}$	275	$^\circ\text{C}$

**Table 2. Thermal Characteristics**

Characteristic	Symbol	Value	Unit
Thermal Resistance by Infrared Measurement, Active Die Surface-to-Case Case Temperature $76^\circ\text{C}$ , $P_D = 66\text{ W}$	$R_{\theta JC}$ (IR)	1.9 (2)	$^\circ\text{C}/\text{W}$
Thermal Resistance by Finite Element Analysis, Junction-to-Case Case Temperature $85^\circ\text{C}$ , $P_D = 65\text{ W}$	$R_{\theta JC}$ (FEA)	2.5 (3)	$^\circ\text{C}/\text{W}$

**Table 3. ESD Protection Characteristics**

Test Methodology	Class
Human Body Model (per JESD22-A114)	1A
Machine Model (per EIA/JESD22-A115)	A
Charge Device Model (per JESD22-C101)	IV

**Table 4. Electrical Characteristics** ( $T_A = 25^\circ\text{C}$  unless otherwise noted)

Characteristic	Symbol	Min	Typ	Max	Unit
----------------	--------	-----	-----	-----	------

**Off Characteristics**

Drain-Source Breakdown Voltage ( $V_{GS} = -8\text{ Vdc}$ , $I_D = 18.9\text{ mAdc}$ )	$V_{(BR)DSS}$	150	—	—	Vdc
---	---------------	-----	---	---	-----

**On Characteristics**

Gate Threshold Voltage ( $V_{DS} = 10\text{ Vdc}$ , $I_D = 18.9\text{ mAdc}$ )	$V_{GS(th)}$	-3.8	-3.1	-2.3	Vdc
Gate Quiescent Voltage ( $V_{DD} = 48\text{ Vdc}$ , $I_D = 190\text{ mAdc}$ , Measured in Functional Test)	$V_{GS(Q)}$	-3.6	-2.6	-2.3	Vdc
Gate-Source Leakage Current ( $V_{DS} = 0\text{ Vdc}$ , $V_{GS} = -5\text{ Vdc}$ )	$I_{GSS}$	-5.9	—	—	mAdc

- Functional operation above  $225^\circ\text{C}$  has not been characterized and is not implied. Operation at  $T_{MAX}$  ( $275^\circ\text{C}$ ) reduces median time to failure by an order of magnitude; operation beyond  $T_{MAX}$  could cause permanent damage.
- Refer to AN1955, *Thermal Measurement Methodology of RF Power Amplifiers*. Go to <http://www.nxp.com/RF> and search for AN1955.
- $R_{\theta JC}$  (FEA) must be used for purposes related to reliability and limitations on maximum junction temperature. MTTF may be estimated by the expression  $MTTF$  (hours) =  $10^{[A + B/(T + 273)]}$ , where  $T$  is the junction temperature in degrees Celsius,  $A = -8.44$  and  $B = 7210$ .

(continued)

**Table 4. Electrical Characteristics** ( $T_A = 25^\circ\text{C}$  unless otherwise noted) (continued)

Characteristic	Symbol	Min	Typ	Max	Unit
<b>Functional Tests</b> <sup>(1)</sup> (In Freescale Test Fixture, 50 ohm system) $V_{DD} = 48\text{ Vdc}$ , $I_{DQ} = 190\text{ mA}$ , $P_{out} = 32\text{ W Avg.}$ , $f = 3500\text{ MHz}$ , Single-Carrier W-CDMA, IQ Magnitude Clipping, Input Signal PAR = 9.9 dB @ 0.01% Probability on CCDF. ACPR measured in 3.84 MHz Channel Bandwidth @ $\pm 5\text{ MHz}$ Offset. [See note on correct biasing sequence.]					
Power Gain	$G_{ps}$	13.5	15.7	18.0	dB
Drain Efficiency	$\eta_D$	31.6	36.7	—	%
Output Peak-to-Average Ratio @ 0.01% Probability on CCDF	PAR	6.6	7.2	—	dB
Adjacent Channel Power Ratio	ACPR	—	-34.1	-31.8	dBc
Input Return Loss	IRL	—	-16	-8	dB

**Load Mismatch** (In Freescale Test Fixture, 50 ohm system)  $I_{DQ} = 190\text{ mA}$ ,  $f = 3500\text{ MHz}$ , 12  $\mu\text{sec}(\text{on})$ , 10% Duty Cycle

VSWR 10:1 at 55 Vdc, 153 W Pulsed CW Output Power (3 dB Input Overdrive from 126 W Pulsed CW Rated Power)	No Device Degradation
---	-----------------------

**Typical Performance** (In Freescale Test Fixture, 50 ohm system)  $V_{DD} = 48\text{ Vdc}$ ,  $I_{DQ} = 190\text{ mA}$ , 3400–3600 MHz Bandwidth

$P_{out}$ @ 1 dB Compression Point, CW	P1dB	—	126	—	W
$P_{out}$ @ 3 dB Compression Point <sup>(2)</sup>	P3dB	—	162	—	W
AM/PM (Maximum value measured at the P3dB compression point across the 3400–3600 MHz bandwidth)	$\Phi$	—	-15.6	—	$^\circ$
VBW Resonance Point (IMD Third Order Intermodulation Inflection Point)	VBW <sub>res</sub>	—	110	—	MHz
Gain Flatness in 200 MHz Bandwidth @ $P_{out} = 32\text{ W Avg.}$	$G_F$	—	0.5	—	dB
Gain Variation over Temperature ( $-30^\circ\text{C}$ to $+85^\circ\text{C}$ )	$\Delta G$	—	0.02	—	dB/ $^\circ\text{C}$
Output Power Variation over Temperature ( $-30^\circ\text{C}$ to $+85^\circ\text{C}$ )	$\Delta P_{1dB}$	—	0.01	—	dB/ $^\circ\text{C}$

**Table 5. Ordering Information**

Device	Tape and Reel Information	Package
A2G35S160-01SR3	R3 Suffix = 250 Units, 32 mm Tape Width, 13-inch Reel	NI-400S-2S

- Part internally input matched.
- P3dB =  $P_{avg} + 7.0\text{ dB}$  where  $P_{avg}$  is the average output power measured using an unclipped W-CDMA single-carrier input signal where output PAR is compressed to 7.0 dB @ 0.01% probability on CCDF.

**NOTE: Correct Biasing Sequence for GaN Depletion Mode Transistors****Turning the device ON**

- Set  $V_{GS}$  to the pinch-off ( $V_P$ ) voltage, typically  $-5\text{ V}$
- Turn on  $V_{DS}$  to nominal supply voltage (50 V)
- Increase  $V_{GS}$  until  $I_{DS}$  current is attained
- Apply RF input power to desired level

**Turning the device OFF**

- Turn RF power off
- Reduce  $V_{GS}$  down to  $V_P$ , typically  $-5\text{ V}$
- Reduce  $V_{DS}$  down to 0 V (Adequate time must be allowed for  $V_{DS}$  to reduce to 0 V to prevent severe damage to device.)
- Turn off  $V_{GS}$

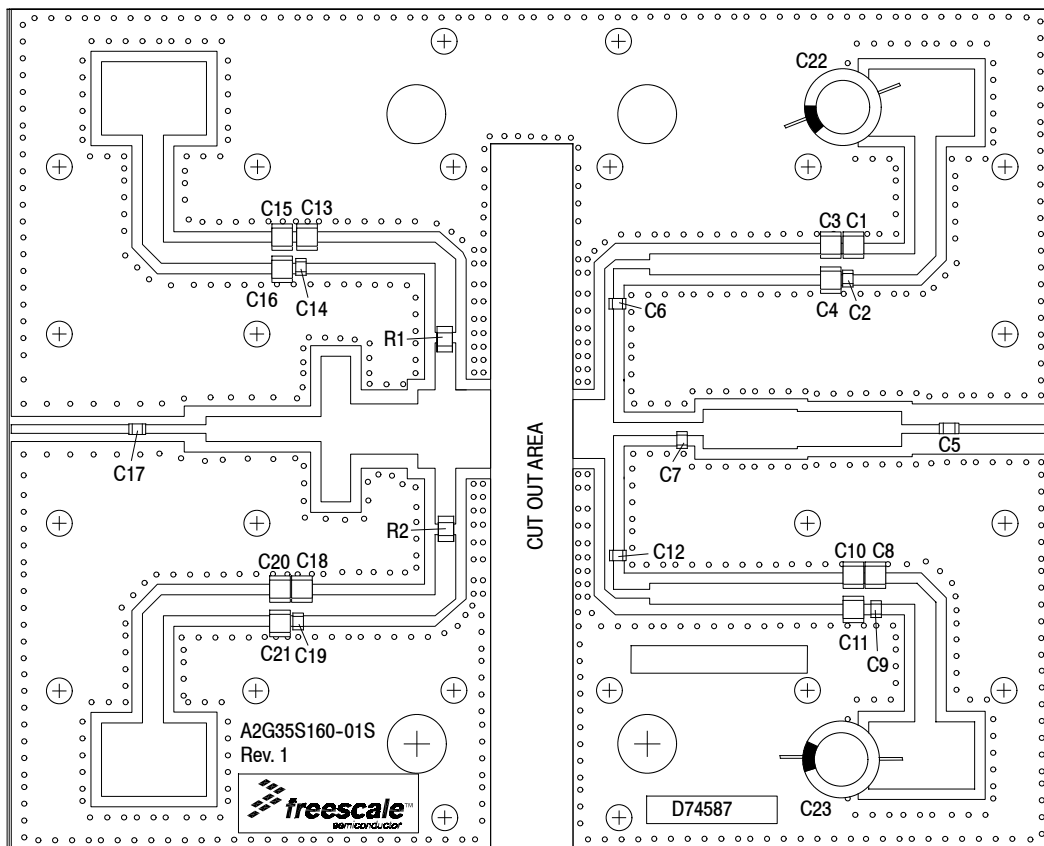
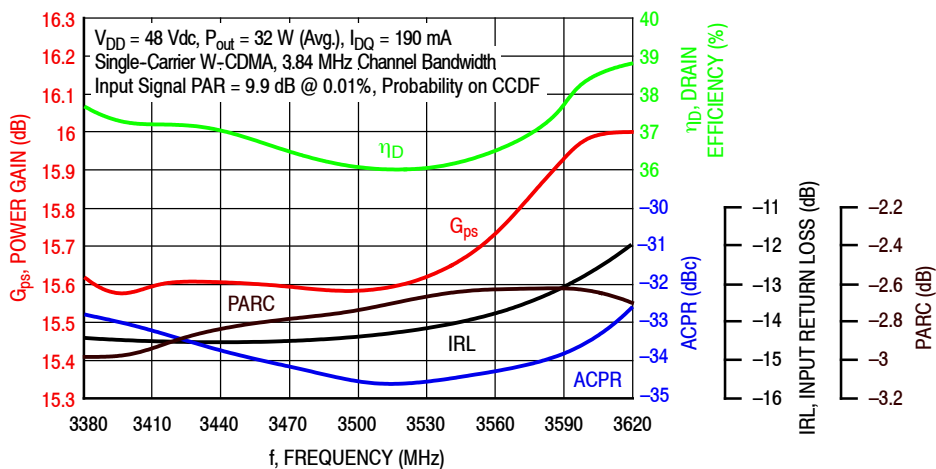

Figure 2. A2G35S160-01SR3 Test Circuit Component Layout

Table 6. A2G35S160-01SR3 Test Circuit Component Designations and Values

Part	Description	Part Number	Manufacturer
C1, C8, C13, C18	0.022 $\mu$ F Chip Capacitors	GRM31MR72A223KA01L	Murata
C2, C9, C14, C19	1 nF Chip Capacitors	GRM1885C2A102JA01D	Murata
C3, C10, C15, C20	1 $\mu$ F Chip Capacitors	GRM31CR72A105KA01L	Murata
C4, C11, C16, C21	10 $\mu$ F Chip Capacitors	GRM32ER61H106KA12L	Murata
C5, C17	12 pF Chip Capacitors	GQM1875C2E120FB12D	Murata
C6, C12	15 pF Chip Capacitors	GQM1875C2E150JB12D	Murata
C7	0.6 pF Chip Capacitor	ATC600F0R6BW250XT	ATC
C22, C23	330 $\mu$ F, 63 V Electrolytic Capacitors	MCRH63V337M13X21-RH	Multicomp
R1, R2	5.60 $\Omega$ , 1/4 W Chip Resistors	CRCW12065R60FKEA	Vishay
PCB	Rogers RO4350B, 0.023", $\epsilon_r = 3.66$	D74587	MTL

### TYPICAL CHARACTERISTICS — 3400–3600 MHz



**Figure 3. Single-Carrier Output Peak-to-Average Ratio Compression (PARC) Broadband Performance @  $P_{out} = 32$  Watts Avg.**

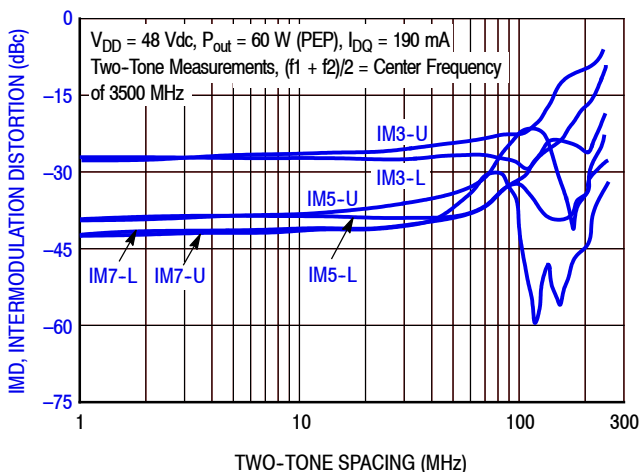

**Figure 4. Intermodulation Distortion Products versus Two-Tone Spacing**

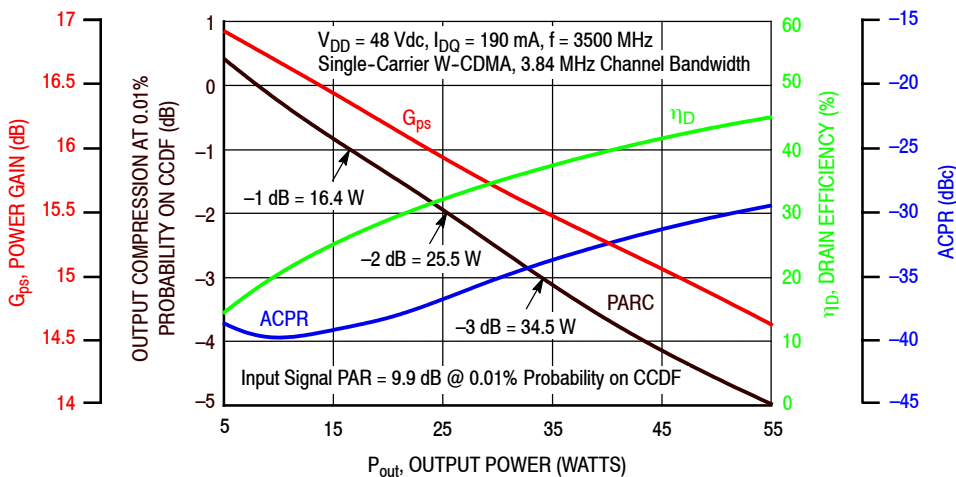

**Figure 5. Output Peak-to-Average Ratio Compression (PARC) versus Output Power**

TYPICAL CHARACTERISTICS — 3400–3600 MHz

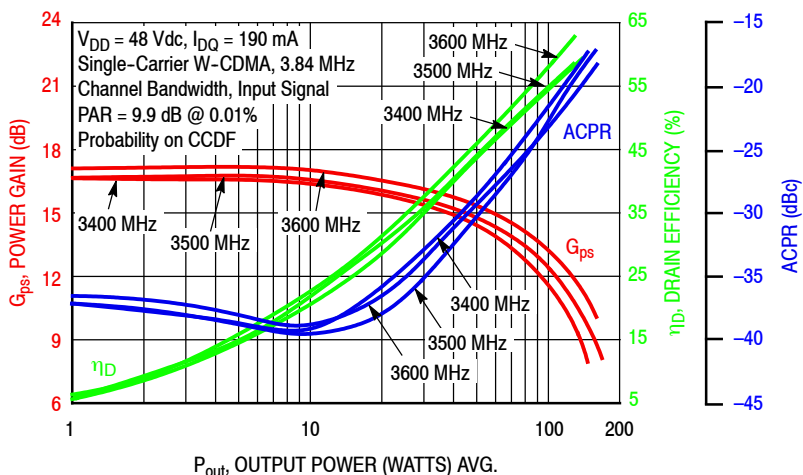

Figure 6. Single-Carrier W-CDMA Power Gain, Drain Efficiency and ACPR versus Output Power

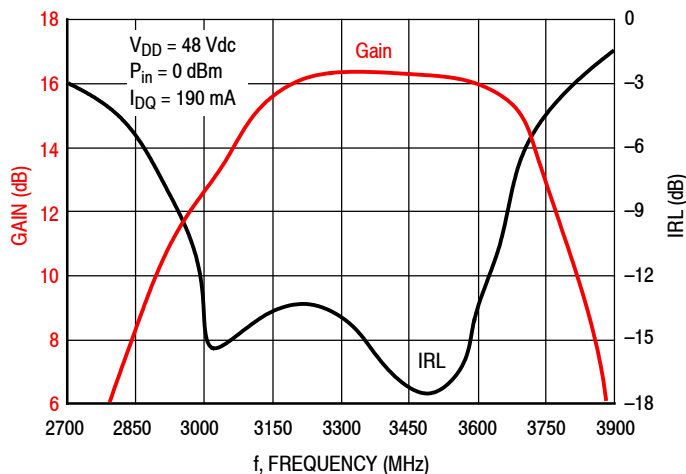
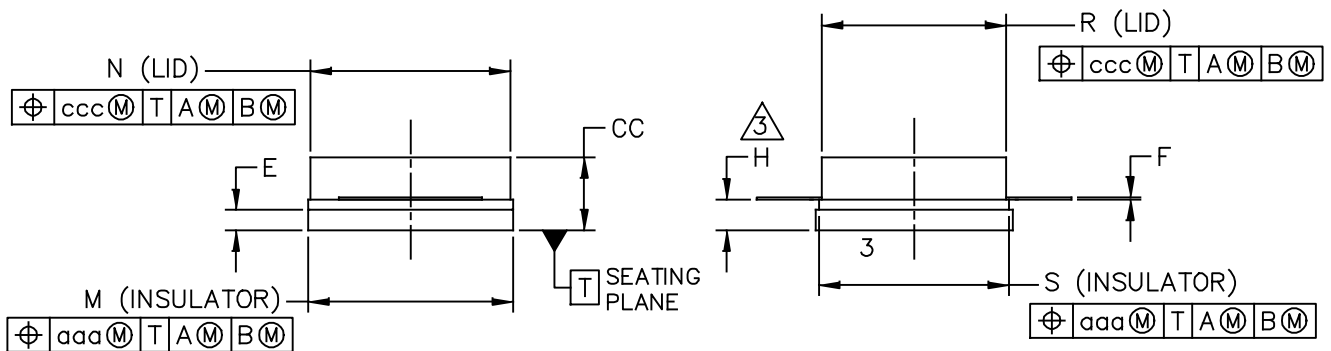
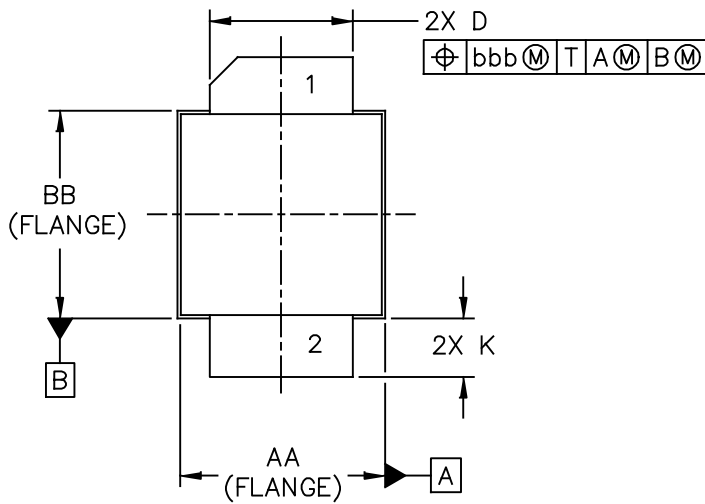

Figure 7. Broadband Frequency Response

## PACKAGE DIMENSIONS



© NXP SEMICONDUCTORS N.V. ALL RIGHTS RESERVED	MECHANICAL OUTLINE	PRINT VERSION NOT TO SCALE
TITLE:  NI-400S-2S	DOCUMENT NO: 98ASA10732D	REV: C
	STANDARD: NON-JEDEC	
	SOT1828-1	13 JAN 2016

NOTES:

1. CONTROLLING DIMENSION: INCH
2. INTERPRET DIMENSIONS AND TOLERANCES PER ASME Y14.5M-1994.

③ DIMENSION H IS MEASURED .030 INCH (0.762 MM) AWAY FROM THE FLANGE TO CLEAR THE EPOXY FLOW OUT REGION PARALLEL TO DATUM B.

4. INPUT & OUTPUT LEADS (PIN 1 & 2) MAY HAVE SMALL FEATURES SUCH AS SQUARE HOLES OR NOTCHES FOR MANUFACTURING CONVENIENCE.

DIM	INCH		MILLIMETER		DIM	INCH		MILLIMETER	
	MIN	MAX	MIN	MAX		MIN	MAX	MIN	MAX
AA	.395	.405	10.03	10.29	aaa	.005		0.13	
BB	.382	.388	9.70	9.86	bbb	.010		0.25	
CC	.125	.163	3.18	4.14	ccc	.015		0.38	
D	.275	.285	6.98	7.24					
E	.035	.045	0.89	1.14					
F	.004	.006	0.10	0.15					
H	.057	.067	1.45	1.70					
K	.0995	.1295	2.53	3.29					
M	.395	.405	10.03	10.29					
N	.385	.395	9.78	10.03					
R	.355	.365	9.02	9.27					
S	.365	.375	9.27	9.53					
© NXP SEMICONDUCTORS N.V. ALL RIGHTS RESERVED			MECHANICAL OUTLINE			PRINT VERSION NOT TO SCALE			
TITLE:  NI-400S-2S					DOCUMENT NO: 98ASA10732D		REV: C		
					STANDARD: NON-JEDEC				
					SOT1828-1		13 JAN 2016		



## PRODUCT DOCUMENTATION, SOFTWARE AND TOOLS

Refer to the following resources to aid your design process.

### Application Notes

- AN1955: Thermal Measurement Methodology of RF Power Amplifiers

### Engineering Bulletins

- EB212: Using Data Sheet Impedances for RF LDMOS Devices

### Software

- RF High Power Model
- .s2p File

### Development Tools

- Printed Circuit Boards

### To Download Resources Specific to a Given Part Number:

1. Go to <http://www.nxp.com/RF>
2. Search by part number
3. Click part number link
4. Choose the desired resource from the drop down menu

## REVISION HISTORY

The following table summarizes revisions to this document.

Revision	Date	Description
0	May 2016	• Initial Release of Data Sheet

## ***How to Reach Us:***

**Home Page:**  
[freescale.com](http://freescale.com)

**Web Support:**  
[freescale.com/support](http://freescale.com/support)

Information in this document is provided solely to enable system and software implementers to use Freescale products. There are no express or implied copyright licenses granted hereunder to design or fabricate any integrated circuits based on the information in this document.

Freescale reserves the right to make changes without further notice to any products herein. Freescale makes no warranty, representation, or guarantee regarding the suitability of its products for any particular purpose, nor does Freescale assume any liability arising out of the application or use of any product or circuit, and specifically disclaims any and all liability, including without limitation consequential or incidental damages. "Typical" parameters that may be provided in Freescale data sheets and/or specifications can and do vary in different applications, and actual performance may vary over time. All operating parameters, including "typicals," must be validated for each customer application by customer's technical experts. Freescale does not convey any license under its patent rights nor the rights of others. Freescale sells products pursuant to standard terms and conditions of sale, which can be found at the following address: [freescale.com/SalesTermsandConditions](http://freescale.com/SalesTermsandConditions).

Freescale and the Freescale logo are trademarks of Freescale Semiconductor, Inc., Reg. U.S. Pat. & Tm. Off. Airfast is a trademark of Freescale Semiconductor, Inc. All other product or service names are the property of their respective owners.

© 2016 Freescale Semiconductor, Inc.



Компания «Океан Электроники» предлагает заключение долгосрочных отношений при поставках импортных электронных компонентов на взаимовыгодных условиях!

Наши преимущества:

- Поставка оригинальных импортных электронных компонентов напрямую с производств Америки, Европы и Азии, а так же с крупнейших складов мира;
- Широкая линейка поставок активных и пассивных импортных электронных компонентов (более 30 млн. наименований);
- Поставка сложных, дефицитных, либо снятых с производства позиций;
- Оперативные сроки поставки под заказ (от 5 рабочих дней);
- Экспресс доставка в любую точку России;
- Помощь Конструкторского Отдела и консультации квалифицированных инженеров;
- Техническая поддержка проекта, помощь в подборе аналогов, поставка прототипов;
- Поставка электронных компонентов под контролем ВП;
- Система менеджмента качества сертифицирована по Международному стандарту ISO 9001;
- При необходимости вся продукция военного и аэрокосмического назначения проходит испытания и сертификацию в лаборатории (по согласованию с заказчиком);
- Поставка специализированных компонентов военного и аэрокосмического уровня качества (Xilinx, Altera, Analog Devices, Intersil, Interpoint, Microsemi, Actel, Aeroflex, Peregrine, VPT, Syfer, Eurofarad, Texas Instruments, MS Kennedy, Miteq, Cobham, E2V, MA-COM, Hittite, Mini-Circuits, General Dynamics и др.);

Компания «Океан Электроники» является официальным дистрибьютором и эксклюзивным представителем в России одного из крупнейших производителей разъемов военного и аэрокосмического назначения «JONHON», а так же официальным дистрибьютором и эксклюзивным представителем в России производителя высокотехнологичных и надежных решений для передачи СВЧ сигналов «FORSTAR».



## JONHON

«JONHON» (основан в 1970 г.)

Разъемы специального, военного и аэрокосмического назначения:

(Применяются в военной, авиационной, аэрокосмической, морской, железнодорожной, горно- и нефтедобывающей отраслях промышленности)

«FORSTAR» (основан в 1998 г.)

ВЧ соединители, коаксиальные кабели,  
кабельные сборки и микроволновые компоненты:

(Применяются в телекоммуникациях гражданского и специального назначения, в средствах связи, РЛС, а так же военной, авиационной и аэрокосмической отраслях промышленности).



Телефон: 8 (812) 309-75-97 (многоканальный)

Факс: 8 (812) 320-03-32

Электронная почта: [ocean@oceanchips.ru](mailto:ocean@oceanchips.ru)

Web: <http://oceanchips.ru/>

Адрес: 198099, г. Санкт-Петербург, ул. Калинина, д. 2, корп. 4, лит. А