

# SST-20-W

## Specialty White LED

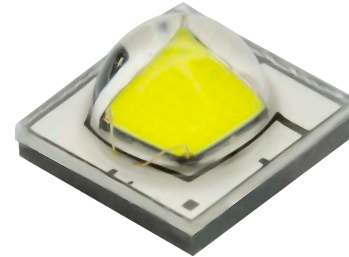

### Table of Contents

General Considerations . . . . 2

Binning Structure . . . . . 3

Chromaticity Bin Kit Codes .5

Ordering Information . . . . . 7

Optical and Electrical Characteristics . . . . . 8

Soldering Profile . . . . . 12

Precautions for Use . . . . . 13

Mechanical Dimensions . . . 14

Reel & Box Packaging . . . . 16

Change History . . . . . 19

### Features:

- High Brightness Cool White LED with maximum output in excess of 900 lm@3A
- Available in 5000K, 5700K and 6500K, 70 CRI (typical) color points
- Compact monolithic emitter ideal for directional lighting applications with high uniformity
- Binned at 85 °C
- Typical efficacy 180 lm/W at 350 mA, Tj 85 °C
- Maximum drive current: 3 A
- Available with 2 industry standard soldering footprint configurations
- High thermal conductivity package - junction thermal resistance of only 1.6 °C/W
- Available with 120° viewing angle
- 8000V HBM ESD rating per JEDEC/ESDA STANDARD JS-001
- Electrically isolated thermal path
- RoHS and REACH compliant

### Applications

- Horticulture grow light
- Automotive light bar, spotlight accessory , headlight
- Bicycle light
- Flashlight
- Torch
- Portable lighting

## General Considerations

### Environmental Considerations:

As a leading provider of solid-state Lighting solutions, Luminus implements strict substance control policies to ensure all of its products are environmentally friendly. As all Luminus LEDs, the SST-20-W series are compliant with the Restriction of Hazardous Substances Directive (RoHS) and REACH directives from the European Community.

### Product Testing:

Every SST-20-W LED is fully production tested to ensure it meets the high quality standards customers have come to expect from Luminus products. Devices are binned to correlated values at 1500 mA, 20 msec pulse condition at  $T_j = 85^{\circ}\text{C}$ . Current and temperature curves are provided in this document allowing users to predict the LED performance and characteristics under their own driving and thermal conditions.

### Reliability:

Luminus SST-20-W LED series are required to pass a rigorous suite of environmental and mechanical stress tests, including mechanical shock, vibration, temperature cycling and humidity. These tests ensure that the devices deliver high performance and achieve reliable long term operation in the automotive and other demanding environments. Please contact Luminus for further information.

## Flux Binning Structure

SST-20-W LEDs are binned for luminous flux based on  $I_f = 1500$  mA and 85 °C junction temperature ( $T_j$ ) conditions.

| Flux Bin (FF) <sup>1</sup> | Min. Flux (lm)<br>1500 mA, 85 °C | Max. Flux (lm)<br>1500 mA, 85 °C | Min. Flux (lm)<br>350 mA, 25 °C | Correlated Minimum Luminous Flux (lm) @ 85 °C <sup>2</sup> |        |         |         |
|----------------------------|----------------------------------|----------------------------------|---------------------------------|--|--------|---------|---------|
|                            |                                  |                                  |                                 | 350 mA   | 700 mA | 2000 mA | 3000 mA |
| M3                         | 705                              | 745                              | 228                             | 207  | 381    | 876     | 1137    |
| M2                         | 665                              | 705                              | 215                             | 195  | 359    | 827     | 1073    |
| L5                         | 620                              | 665                              | 200                             | 182  | 335    | 771     | 1000    |
| L4                         | 585                              | 620                              | 189                             | 172  | 316    | 727     | 944     |
| L3                         | 560                              | 585                              | 180                             | 164  | 302    | 696     | 903     |
| L2                         | 530                              | 560                              | 172                             | 155  | 286    | 659     | 855     |
| K5                         | 505                              | 530                              | 163                             | 148  | 272    | 628     | 814     |
| K4                         | 475                              | 505                              | 153                             | 139  | 256    | 591     | 766     |
| K3                         | 445                              | 475                              | 143                             | 130  | 240    | 553     | 718     |
| K2                         | 415                              | 445                              | 134                             | 122  | 224    | 516     | 669     |
| J5                         | 390                              | 415                              | 125                             | 114  | 210    | 485     | 629     |

Note 1: Luminus maintains a +/- 6% tolerance on flux measurement.

Note 2: Correlated flux values at 350 mA, 700 mA, 2000 mA and 3000 mA are for reference only.

## Forward Voltage Binning Structure

SST-20-W LEDs are binned for forward voltage based on  $I_f = 1500$  mA and 85 °C junction temperature ( $T_j$ ) conditions.

| Voltage Bin <sup>3</sup> | Minimum Voltage (V) | Maximum Voltage (V) |
|--------------------------|---------------------|---------------------|
| VH                       | 2.5                 | 2.7                 |
| VJ                       | 2.7                 | 2.9                 |
| VK                       | 2.9                 | 3.1                 |
| VL                       | 3.1                 | 3.3                 |

Note 3: Individual voltage bins are not orderable.

### Chromaticity Bin Definitions

| CCT  | Bin code | CIE-X  | CIE-Y  | Bin code | CIE-X  | CIE-Y  | Bin code | CIE-X  | CIE-Y  | Bin code | CIE-X  | CIE-Y  |
|------|----------|--------|--------|----------|--------|--------|----------|--------|--------|----------|--------|--------|
| 7500 | AA       | 0.295  | 0.297  | AB       | 0.292  | 0.306  | AC       | 0.2984 | 0.3133 | AD       | 0.2984 | 0.3133 |
|      |          | 0.292  | 0.306  |          | 0.2895 | 0.3135 |          | 0.2962 | 0.322  |          | 0.3048 | 0.3207 |
|      |          | 0.2984 | 0.3133 |          | 0.2962 | 0.322  |          | 0.3028 | 0.3304 |          | 0.3068 | 0.3113 |
|      |          | 0.3009 | 0.3042 |          | 0.2984 | 0.3133 |          | 0.3048 | 0.3207 |          | 0.3009 | 0.3042 |
|      | AH       | 0.298  | 0.288  | AE       | 0.2895 | 0.3135 | AF       | 0.2962 | 0.322  | AG       | 0.3037 | 0.2937 |
|      |          | 0.295  | 0.297  |          | 0.287  | 0.321  |          | 0.2937 | 0.3312 |          | 0.3009 | 0.3042 |
|      |          | 0.3009 | 0.3042 |          | 0.2937 | 0.3312 |          | 0.3005 | 0.3415 |          | 0.3068 | 0.3113 |
|      |          | 0.3037 | 0.2937 |          | 0.2962 | 0.322  |          | 0.3028 | 0.3304 |          | 0.3093 | 0.2993 |
| 6500 | BA       | 0.3048 | 0.3207 | BB       | 0.3028 | 0.3304 | BC       | 0.3115 | 0.3391 | BD       | 0.313  | 0.329  |
|      |          | 0.313  | 0.329  |          | 0.3115 | 0.3391 |          | 0.3205 | 0.3481 |          | 0.3213 | 0.3373 |
|      |          | 0.3144 | 0.3186 |          | 0.313  | 0.329  |          | 0.3213 | 0.3373 |          | 0.3221 | 0.3261 |
|      |          | 0.3068 | 0.3113 |          | 0.3048 | 0.3207 |          | 0.313  | 0.329  |          | 0.3144 | 0.3186 |
|      | BH       | 0.3068 | 0.3113 | BE       | 0.3005 | 0.3415 | BF       | 0.3099 | 0.3509 | BG       | 0.3144 | 0.3186 |
|      |          | 0.3144 | 0.3186 |          | 0.3099 | 0.3509 |          | 0.3196 | 0.3602 |          | 0.3221 | 0.3261 |
|      |          | 0.3161 | 0.3059 |          | 0.3115 | 0.3391 |          | 0.3205 | 0.3481 |          | 0.3231 | 0.312  |
|      |          | 0.3093 | 0.2993 |          | 0.3028 | 0.3304 |          | 0.3115 | 0.3391 |          | 0.3161 | 0.3059 |
| 5700 | CA       | 0.3215 | 0.335  | CB       | 0.3207 | 0.3462 | CC       | 0.329  | 0.3538 | CD       | 0.329  | 0.3417 |
|      |          | 0.329  | 0.3417 |          | 0.329  | 0.3538 |          | 0.3376 | 0.3616 |          | 0.3371 | 0.349  |
|      |          | 0.329  | 0.33   |          | 0.329  | 0.3417 |          | 0.3371 | 0.349  |          | 0.3366 | 0.3369 |
|      |          | 0.3222 | 0.3243 |          | 0.3215 | 0.335  |          | 0.329  | 0.3417 |          | 0.3290 | 0.3300 |
|      | CH       | 0.3222 | 0.3243 | CE       | 0.3196 | 0.3602 | CF       | 0.329  | 0.369  | CG       | 0.329  | 0.33   |
|      |          | 0.329  | 0.33   |          | 0.329  | 0.369  |          | 0.3381 | 0.3762 |          | 0.3366 | 0.3369 |
|      |          | 0.329  | 0.318  |          | 0.329  | 0.3538 |          | 0.3376 | 0.3616 |          | 0.3361 | 0.3245 |
|      |          | 0.3231 | 0.312  |          | 0.3207 | 0.3462 |          | 0.329  | 0.3538 |          | 0.3290 | 0.3180 |
| 5000 | DA       | 0.3371 | 0.349  | DB       | 0.3376 | 0.3616 | DC       | 0.3463 | 0.3687 | DD       | 0.3451 | 0.3554 |
|      |          | 0.3451 | 0.3554 |          | 0.3463 | 0.3687 |          | 0.3551 | 0.376  |          | 0.3533 | 0.362  |
|      |          | 0.344  | 0.3427 |          | 0.3451 | 0.3554 |          | 0.3533 | 0.362  |          | 0.3515 | 0.3487 |
|      |          | 0.3366 | 0.3369 |          | 0.3371 | 0.349  |          | 0.3451 | 0.3554 |          | 0.3440 | 0.3427 |
|      | DH       | 0.3366 | 0.3369 | DE       | 0.3381 | 0.3762 | DF       | 0.348  | 0.384  | DG       | 0.344  | 0.3428 |
|      |          | 0.3366 | 0.3428 |          | 0.348  | 0.384  |          | 0.3571 | 0.3907 |          | 0.3515 | 0.3487 |
|      |          | 0.3366 | 0.3307 |          | 0.3463 | 0.3687 |          | 0.3551 | 0.376  |          | 0.3495 | 0.3339 |
|      |          | 0.3366 | 0.3245 |          | 0.3376 | 0.3616 |          | 0.3463 | 0.3687 |          | 0.3429 | 0.3307 |

**SST-20-W Cool White Color Space  
Plotted on the ANSI 1931 Curve**

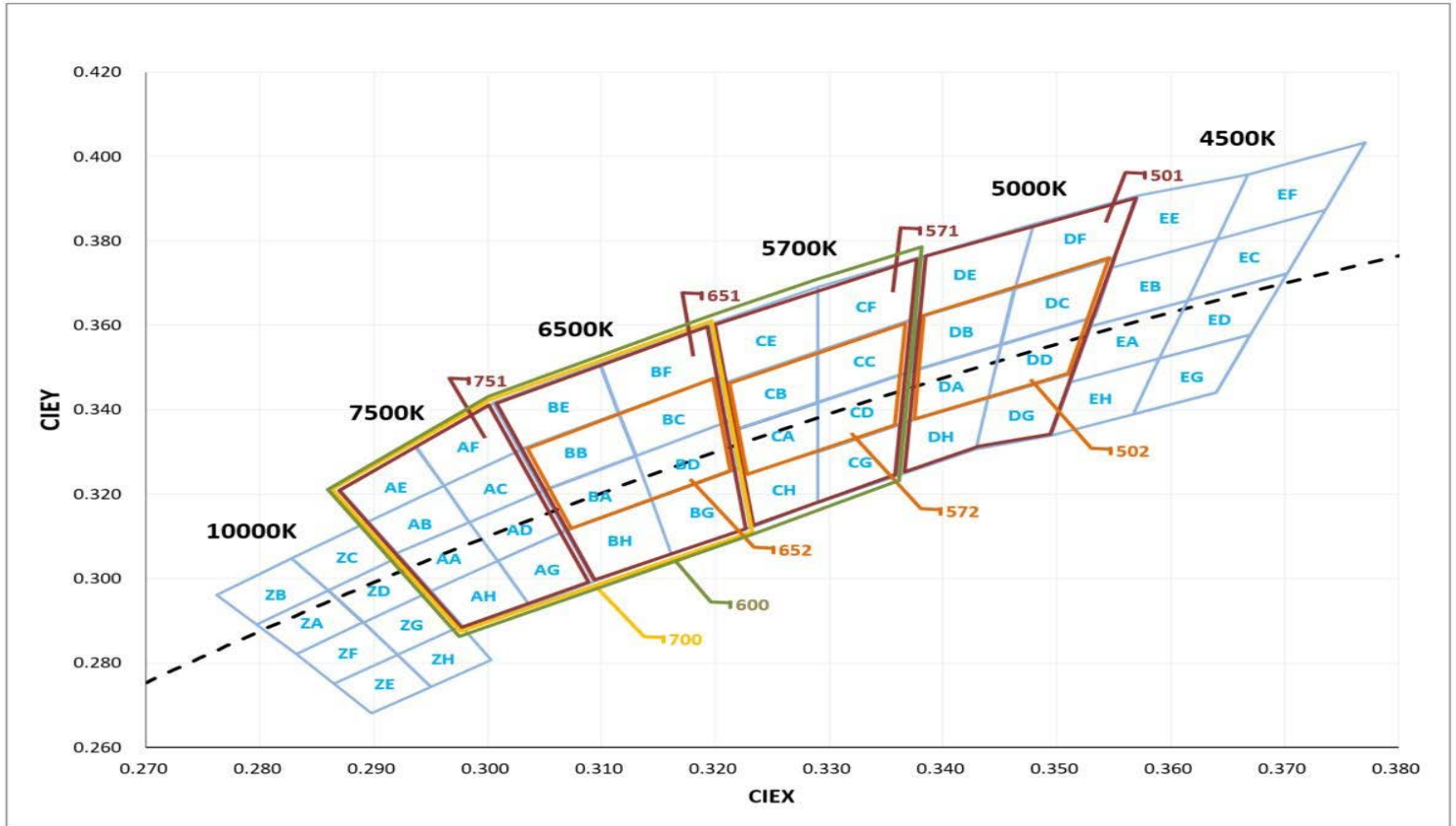

**Chromaticity Bin Kit Codes**

| CCT   | Bin Kit | Chromaticity Bins  |
|-------|---------|--|
| 5000K | 501     | DA, DB, DC, DD, DE, DF, DG, DH   |
|       | 502     | DA, DB, DC, DD   |
| 5700K | 571     | CA, CB, CC, CD, CE, CF, CG, CH   |
|       | 572     | CA, CB, CC, CD   |
| 6000K | 600     | AA, AB, AC, AD, AE, AF, AG, BH, BA, BB, BC, BD, BE, BF, BG, BH, CA, CB, CC, CD, CE, CF, CG, CH |
| 6500K | 651     | BA, BB, BC, BD, BE, BF, BG, BH   |
|       | 652     | BA, BB, BC, BD   |
| 7500K | 751     | AA, AB, AC, AD, AE, AF, AG, AH   |

### CRI Code Definitions

| CRI Code | Min. CRI |
|----------|----------|
| S        | 65       |
| E        | 70       |
| F        | 80       |
| G        | 90       |
| H        | 95       |

### Part Numbering Nomenclature

SST — 20 — <WXY> — <PAA(A)> — <FFCCC>

| Product Family  | LED Emission Area      | Color   | Package Configuration   | Bin Kit  |
|---|------------------------|---|---|--|
| S: Surface mount<br>S: Lensed<br>T: Single monolithic emitter | 20=2.0 mm <sup>2</sup> | W: White<br>X: Temperature<br>C: Cool White<br>D: Daylight White<br>Y: CRI Code<br>see page 5 | P: Soldering pad configuration<br>A type - see page 14<br>B type - see page 15<br>AA(A): Viewing angle 120° | See Tables<br>FF = minimum flux bin<br>CCC: Chromaticity bin kit |

### Ordering Part Numbers

| CCT   | Min. Flux Bin <sup>1</sup> | Min. Flux (lm) | Chromaticity Bin Kit Code <sup>2</sup> | Solder Pad Config. <sup>3</sup> | Viewing Angle | Ordering Part Numbers |
|-------|----------------------------|----------------|--|---------------------------------|---------------|-----------------------|
| 5000K | L2                         | 530            | 501                                    | A                               | 120           | SST-20-WDS-A120-L2501 |
|       |                            |                | 501                                    | B                               | 120           | SST-20-WDS-B120-L2501 |
|       |                            |                | 502                                    | A                               | 120           | SST-20-WDS-A120-L2502 |
|       |                            |                | 502                                    | B                               | 120           | SST-20-WDS-B120-L2502 |
|       | L3                         | 560            | 501                                    | A                               | 120           | SST-20-WDS-A120-L3501 |
|       |                            |                | 501                                    | B                               | 120           | SST-20-WDS-B120-L3501 |
|       |                            |                | 502                                    | A                               | 120           | SST-20-WDS-A120-L3502 |
|       |                            |                | 502                                    | B                               | 120           | SST-20-WDS-B120-L3502 |
| 5700K | L2                         | 530            | 571                                    | A                               | 120           | SST-20-WDS-A120-L2571 |
|       |                            |                | 571                                    | B                               | 120           | SST-20-WDS-B120-L2571 |
|       |                            |                | 572                                    | A                               | 120           | SST-20-WDS-A120-L2572 |
|       |                            |                | 572                                    | B                               | 120           | SST-20-WDS-B120-L2572 |
|       | L3                         | 560            | 571                                    | A                               | 120           | SST-20-WDS-A120-L3571 |
|       |                            |                | 571                                    | B                               | 120           | SST-20-WDS-B120-L3571 |
|       |                            |                | 572                                    | A                               | 120           | SST-20-WDS-A120-L3572 |
|       |                            |                | 572                                    | B                               | 120           | SST-20-WDS-B120-L3572 |
| 6000K | L3                         | 560            | 600                                    | A                               | 120           | SST-20-WCS-A120-L3600 |
|       |                            |                | 600                                    | B                               | 120           | SST-20-WCS-B120-L3600 |
|       | L4                         | 585            | 600                                    | A                               | 120           | SST-20-WCS-A120-L4600 |
|       |                            |                | 600                                    | B                               | 120           | SST-20-WCS-B120-L4600 |
| 6500K | L3                         | 560            | 651                                    | A                               | 120           | SST-20-WCS-A120-L3651 |
|       |                            |                | 651                                    | B                               | 120           | SST-20-WCS-B120-L3651 |
|       |                            |                | 652                                    | A                               | 120           | SST-20-WCS-A120-L3652 |
|       |                            |                | 652                                    | B                               | 120           | SST-20-WCS-B120-L3652 |
|       | L4                         | 585            | 651                                    | A                               | 120           | SST-20-WCS-A120-L4651 |
|       |                            |                | 651                                    | B                               | 120           | SST-20-WCS-B120-L4651 |
|       |                            |                | 652                                    | A                               | 120           | SST-20-WCS-A120-L4652 |
|       |                            |                | 652                                    | B                               | 120           | SST-20-WCS-B120-L4652 |
| 7500K | L2                         | 560            | 751                                    | A                               | 120           | SST-20-WCS-A120-L2751 |
|       |                            |                | 751                                    | B                               | 120           | SST-20-WCS-B120-L2751 |

Note 1: The minimum flux of each bin kit is determined by the minimum flux bin as defined on page 3. Higher flux bins are eligible to ship against shown bin kits and part numbers.

Note 2: See page 5 for chromaticity bin kit definitions.

Note 3: A and B versions correspond to soldering pad configurations. All product mechanical, electrical and optical specifications are otherwise identical.

Example: the part number SST-20-WCS-A120-L3651 refers to a part with type A package configuration, 120 degree viewing angle, flux greater than 560.

**SST-20-W Product Characteristics<sup>1</sup>**

| Parameter   | Symbol               | Minimum                | Typical |       |       |       | Maximum | Unit                 |
|---|----------------------|------------------------|---------|-------|-------|-------|---------|----------------------|
|   |                      |                        | 5000K   | 5700K | 6500K | 7500K |         |                      |
| Forward Current at test   | $I_F$                |                        | 1500    |       |       |       |         | mA                   |
| Forward Voltage   | $V_F$                | 2.7                    | 3.0     |       |       |       | 3.3     | V                    |
| Luminous Flux   | $\phi_v$             |                        | 540     | 560   | 585   | 590   |         | lm                   |
| Radiometric Flux <sup>4</sup>                                   | $\phi_e$             |                        | 533     | 548   | 559   | 565   |         | mW                   |
| Photosynthetic Photon Flux (400nm to 700nm window) <sup>4</sup> | PPF                  |                        | 2.37    | 2.43  | 2.44  | 2.45  |         | $\mu\text{mol/s}$    |
| Photosynthetic Photon Flux Efficacy <sup>4</sup>                | PPF/W                |                        | 2.42    | 2.48  | 2.49  | 2.5   |         | $\mu\text{mol/J}$    |
| Viewing Angle   | A120, B120           | $2\ \varnothing_{1/2}$ | 120     |       |       |       |         | Degrees              |
| Color Rendering Index   | CRI                  | 65                     | 70      |       |       |       |         |                      |
| Forward Current (CW) <sup>2</sup>                               | $I_{fmin}, I_{fmax}$ | 0.2                    |         |       |       |       | 3       | A                    |
| Maximum Surge Current   | $I_{f-smax}$         |                        |         |       |       |       | 4       | A                    |
| Maximum Reverse Current <sup>3</sup>                            | $I_{rev}$            |                        |         |       |       |       | N.A.    |                      |
| LED Junction Temperature  | $T_j$                |                        |         |       |       |       | 150     | $^{\circ}\text{C}$   |
| ESD withstand Voltage<br>HBM Per JEDEC/ESDA STANDARD JS-001     | $V_{HBM}$            | 8000                   |         |       |       |       |         | V                    |
| ESD withstand Voltage<br>CDM Per JEDEC/ESDA STANDARD JS-002     | $V_{CDM}$            | 1000                   |         |       |       |       |         | V                    |
| Operating Temperature   | $T_{OPR}$            | - 40                   |         |       |       |       | 100     | $^{\circ}\text{C}$   |
| Thermal resistance junction to case (electrical)                | $R_{\theta_{JC-EL}}$ |                        | 1.6     |       |       |       |         | $^{\circ}\text{C/W}$ |

Note 1: Values are at 85°C unless otherwise noted

Note 2: Sustained operation at maximum current will result in shortened lifetime.

Note 3: Not designed for reverse voltage operation.

Note 4: Values are at 350 mA,  $T_j$  25 °C



## Optical & Electrical Characteristics

### Relative Luminous Flux vs. Forward Current

$\phi_v/\phi_v(1.5A)$  Single Pulse 20ms  $T_j = 85^\circ C$

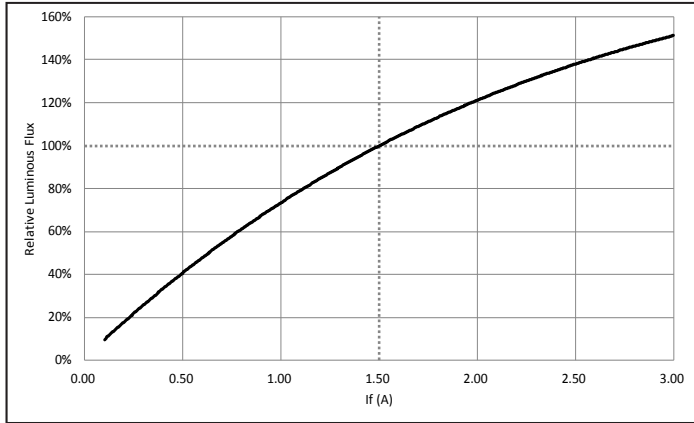

### Relative Luminous Flux vs. Temperature (Tj)

$\phi_v/\phi_v(85^\circ C)$  Single Pulse 20ms  $I_f = 1.5A$

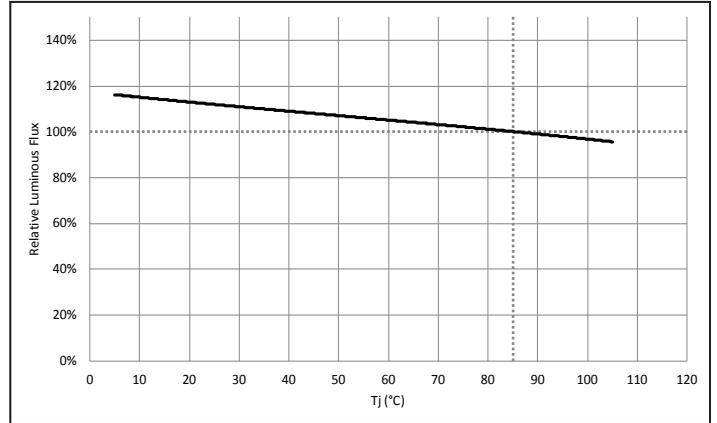

### Forward Voltage vs. Forward Current

$V_f(I_f)$  Single Pulse 20ms  $T_j = 85^\circ C$

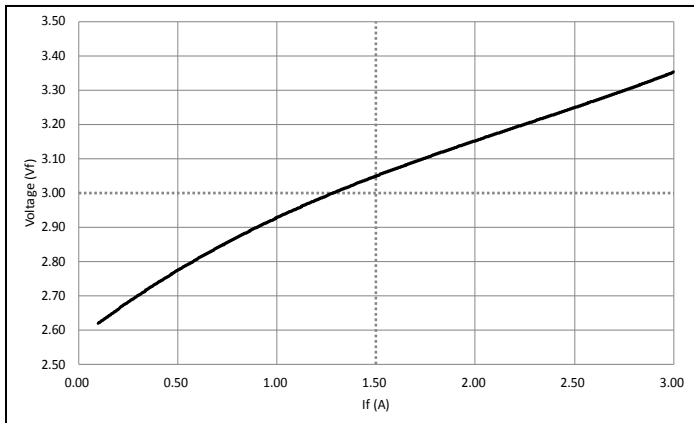

### Relative Forward Voltage vs. Temperature (Tj)

$\Delta V_f = V(T_j) - V(85^\circ C)$  Single Pulse 20ms  $I_f = 1.5A$

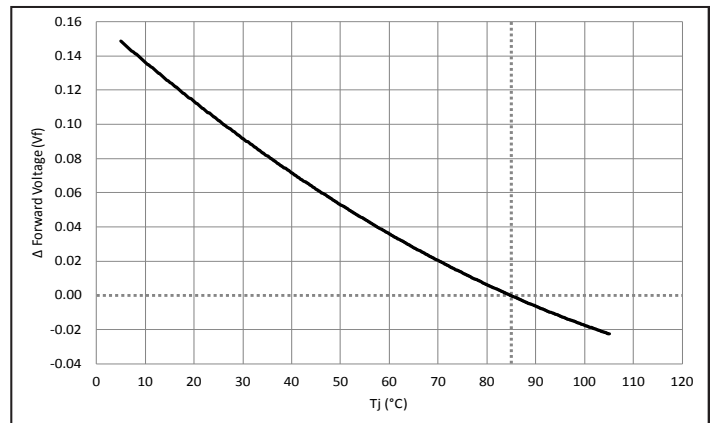

### Relative Chromaticity vs. Forward Current

$\Delta CIE_{x,y} = CIE_{x,y}(I_f) - CIE_{x,y}(1.5A)$ , Single Pulse 20ms  $T_j = 85^\circ C$

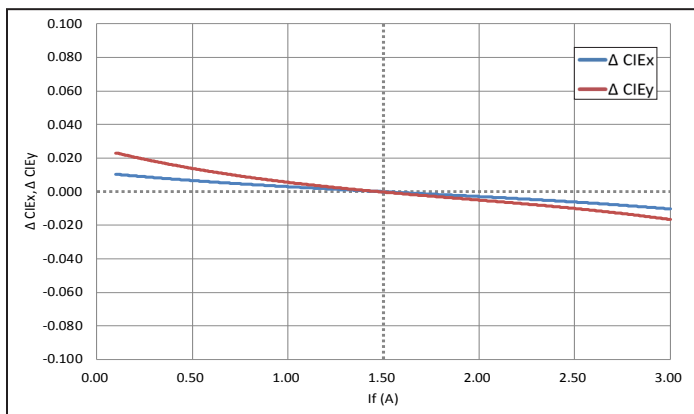

### Relative Chromaticity vs. Temperature (Tj)

$\Delta CIE_{x,y} = CIE_{x,y}(T_j) - CIE_{x,y}(85^\circ C)$  Single Pulse 20ms  $I_f = 1.5A$

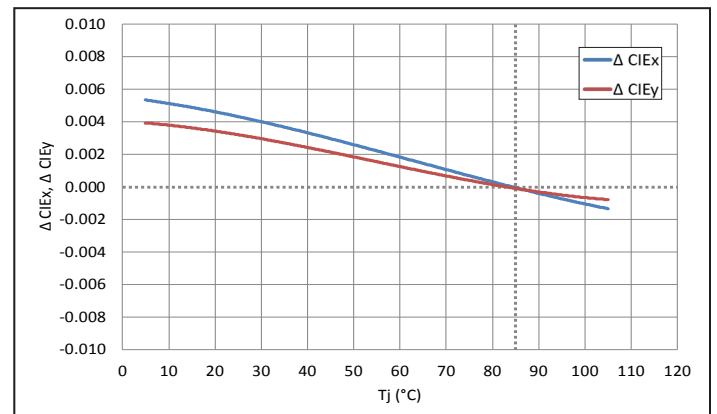

## Optical & Electrical Characteristics

### Typical Relative Radiant Power (%)<sup>1</sup>

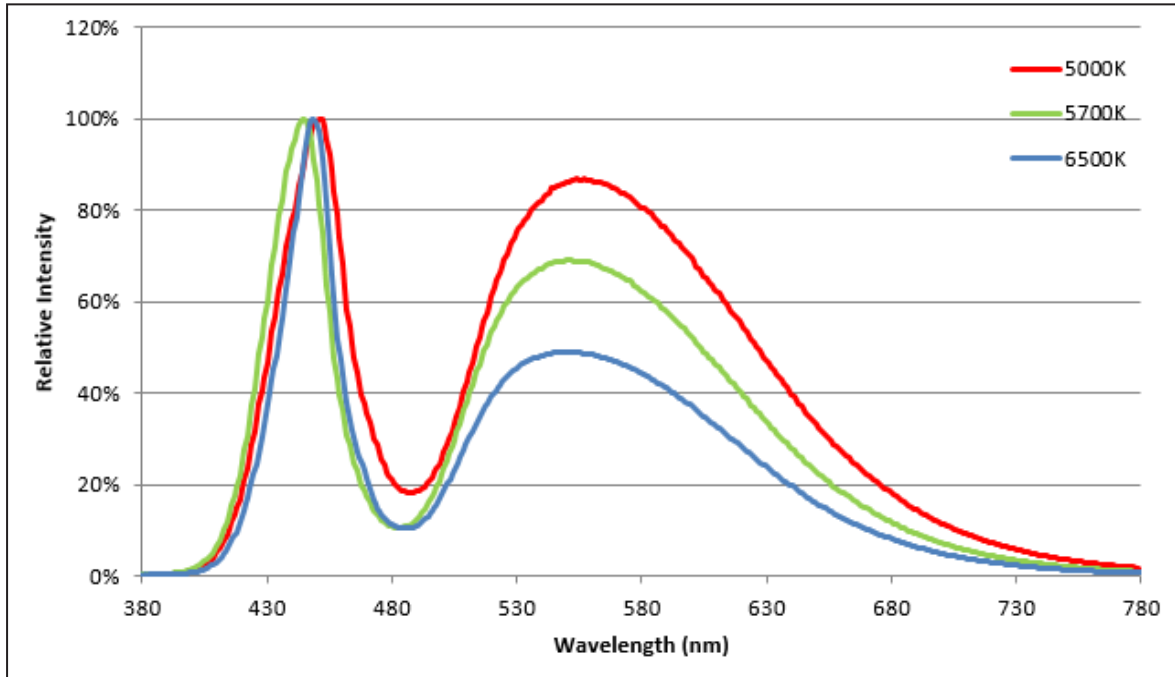

### Typical Angular Pattern of Radiant Power Types A120 and B120<sup>2</sup>

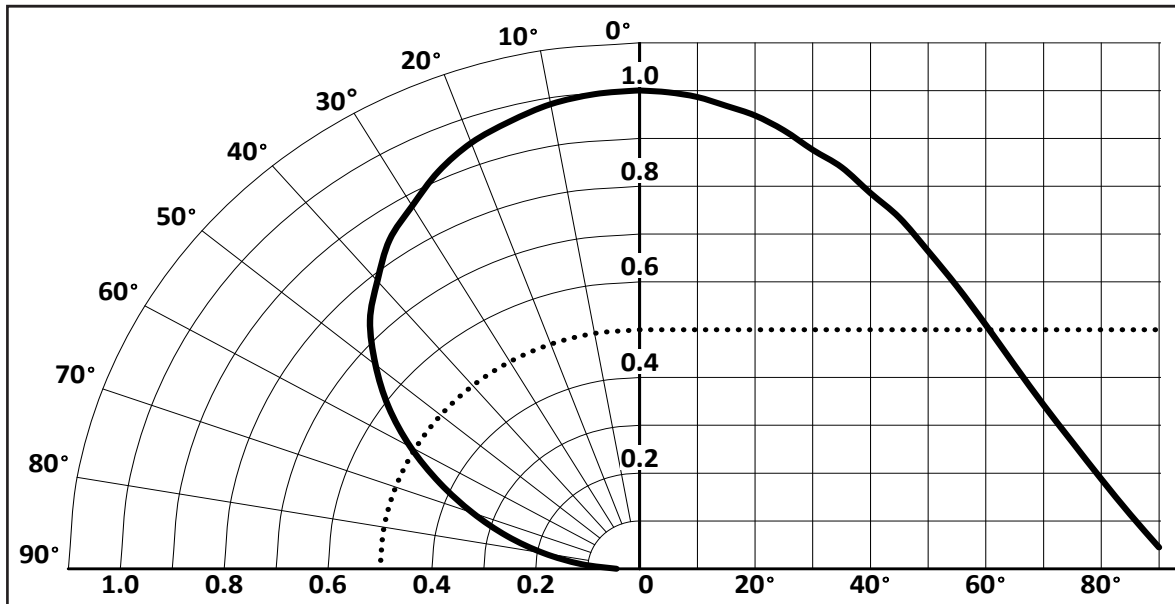

Note 1: Relative radiant power measurements were made at 1.5 A, 85 °C.

Note 2: Angular pattern measurements were made at 1.5 A, 25 °C.

## Thermal Resistance

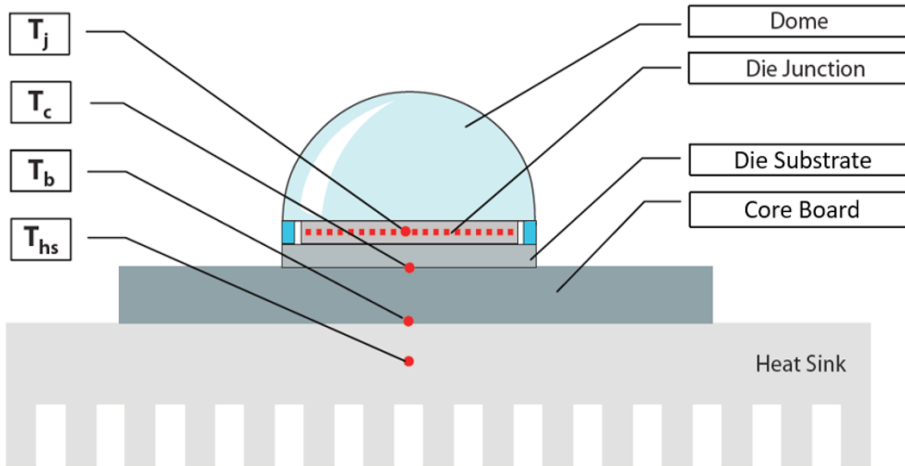

### Typical Thermal Resistance

|             |           |
|-------------|-----------|
| $R_{j-c}^1$ | 1.60 °C/W |
| $R_{j-b}^1$ | 2.54 °C/W |

Note 1: Thermal resistance values are based on rapid thermal transient testing results.

Note 2: Thermal resistance is measured using a SAC305 solder and a Cu-pedestal MCPCB.

Note 3: The values represent the electrical thermal resistance @2A operation @25deg.

Drive Current (A) vs. T case (deg C)

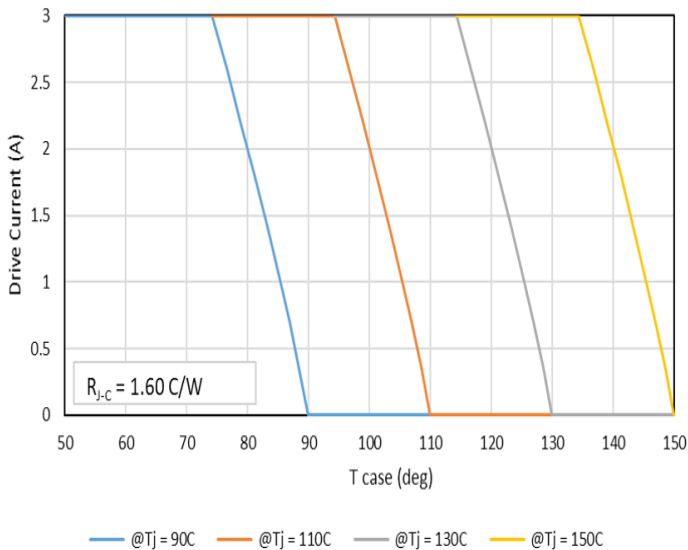

Drive Current (A) vs. T board (deg C)

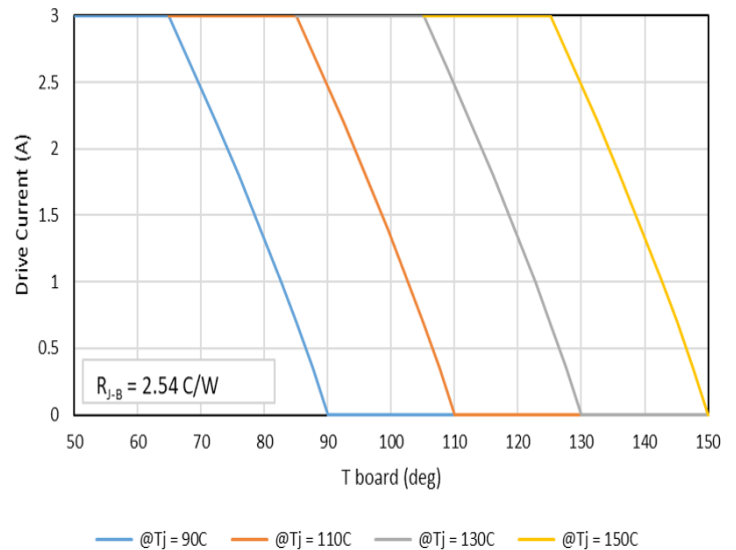

## Soldering Profile

SAC 305 Reflow Profile Window For Low Density Boards

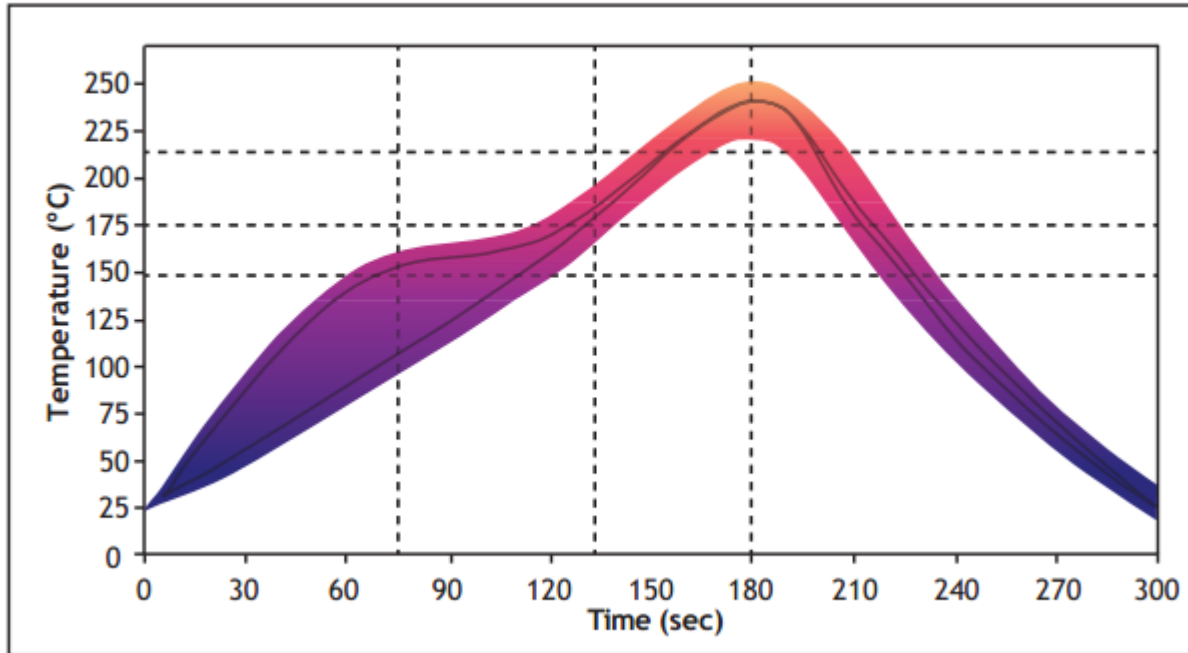

Lead free solder guideline for low density boards

| Solder Profile Stage               | Lead-Free Solder   | Lead-based Solder  |
|------------------------------------|--------------------|--------------------|
| Profile length, Ambient to Peak    | 2.75 - 3.5 minutes | 2.75 - 3.5 minutes |
| Time Maintained Above: Temperature | 217 °C             | 183 °C             |
| Time Maintained Above: Time        | 30 - 60 seconds    | 30 - 60 seconds    |
| Cooldown Rate                      | ≤4° C/sec          | ≤4° C/sec          |
| Cooldown Duration                  | 45 ± 15 sec        | 45 ± 15 sec        |

Note 1: Temperatures are taken and monitored at the component copper layer.

Note 2: Optimum profile may differ due to oven type, circuit board or assembly layout.

Note 3: Recommended lead free, no-clean solder: AIM NC254-SAC305.

Note 4: Refer to APN-001473 soldering and handling application note for additional solder profiles and details.

Note 5: MSL- Level 2A (Glass Lens); MSL Level 1 (Over Molded Design)

## Precautions for Use

### Storage:

SST-20-W LEDs have an MSL 3 moisture sensitivity rating and should be handled per JEDEC J-STD-020. In addition, Luminus recommends the following storage guidelines.

1. The recommended storage condition is between 5 °C and 30 °C and relative humidity less than or equal to 85% RH in its original package.

The LED's electrode and leadframe are a silver plated copper alloy. The silver surface may be affected by its environment. Please avoid conditions which may cause the LEDs to corrode or become discolored. The corrosion or discoloration might lower the solderability or affect the optical characteristics of the device.

Please avoid rapid transitions in ambient temperature, especially in high humidity environments where condensation can occur.

### Static Electricity:

1. The products are sensitive to static electricity and care should be taken when handling them.
2. Static electricity or surge voltage will damage the LEDs. It is recommended to wear an anti-electrostatic wristband or anti-electrostatic gloves when handling the LEDs.
3. All devices, equipment and machinery must be properly grounded. It is recommended that measures be taken against surge voltage to the equipment that mounts the LEDs.

### Vision Advisory

**WARNING:** Looking at an exposed LED during operation can result in eye injury. This LED products has been classified as Risk Group 2 for blue light hazard according to the IEC 62471.

## Mechanical Dimensions<sup>1</sup>

### A120 Package Configuration

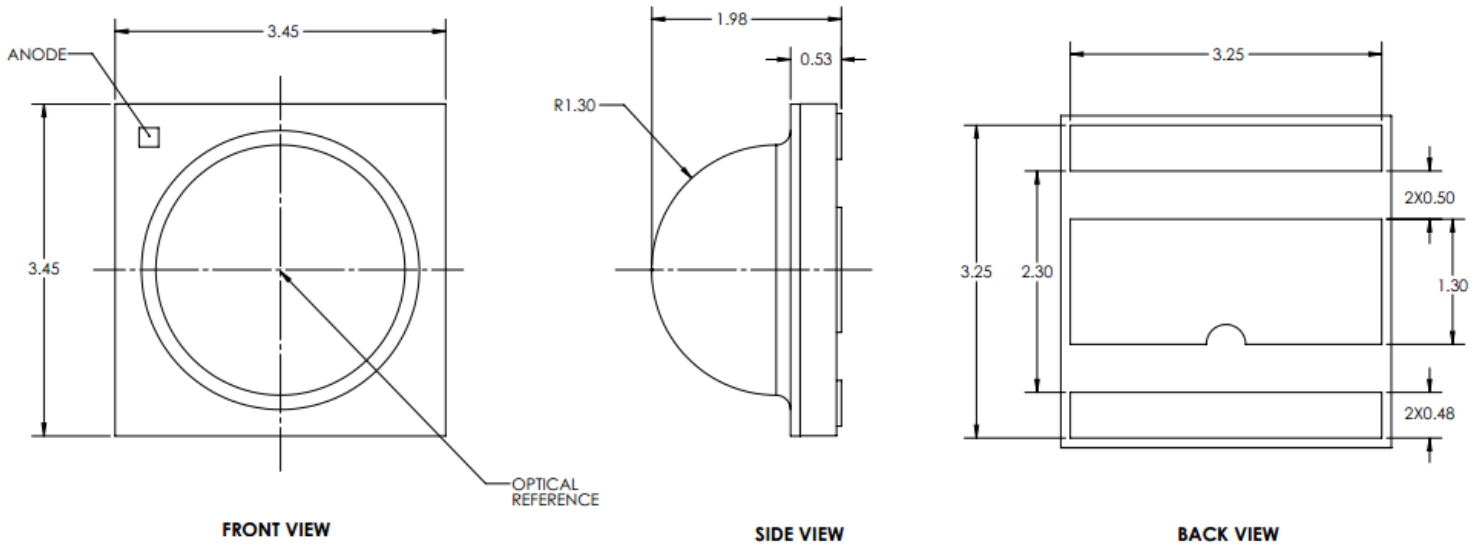

## Recommended PCB Solder Pad and Stencil Pattern<sup>1</sup>

### A120 Package Configuration

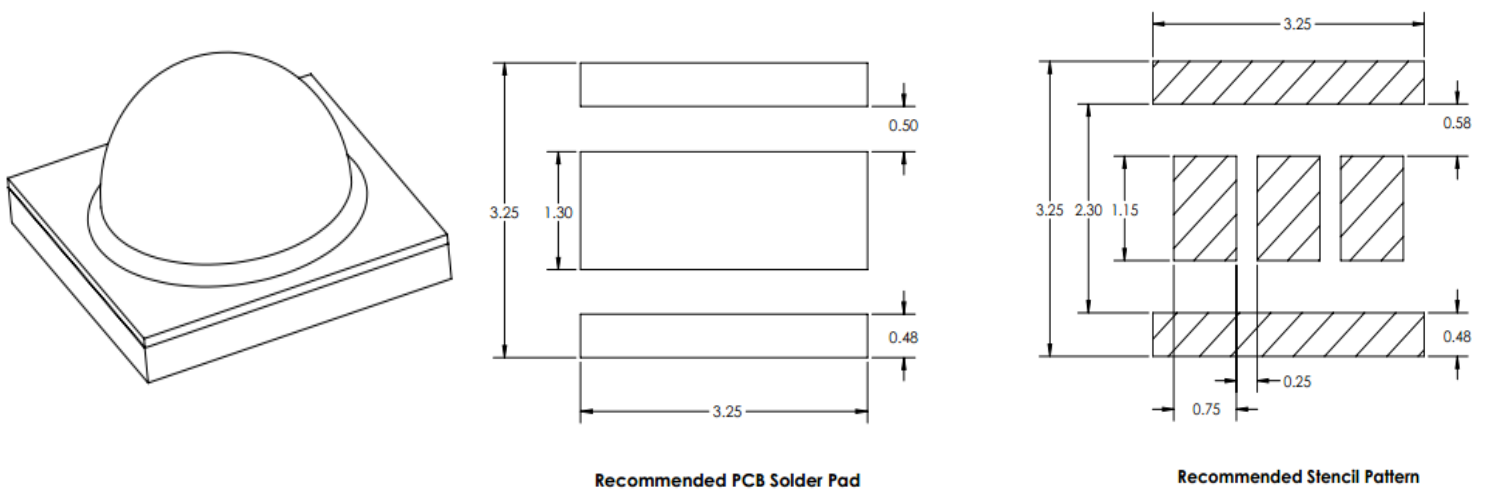

Note 1: Dimensions are in millimeters +/- 0.13 mm

## Mechanical Dimensions<sup>1</sup>

### B120 Package Configuration

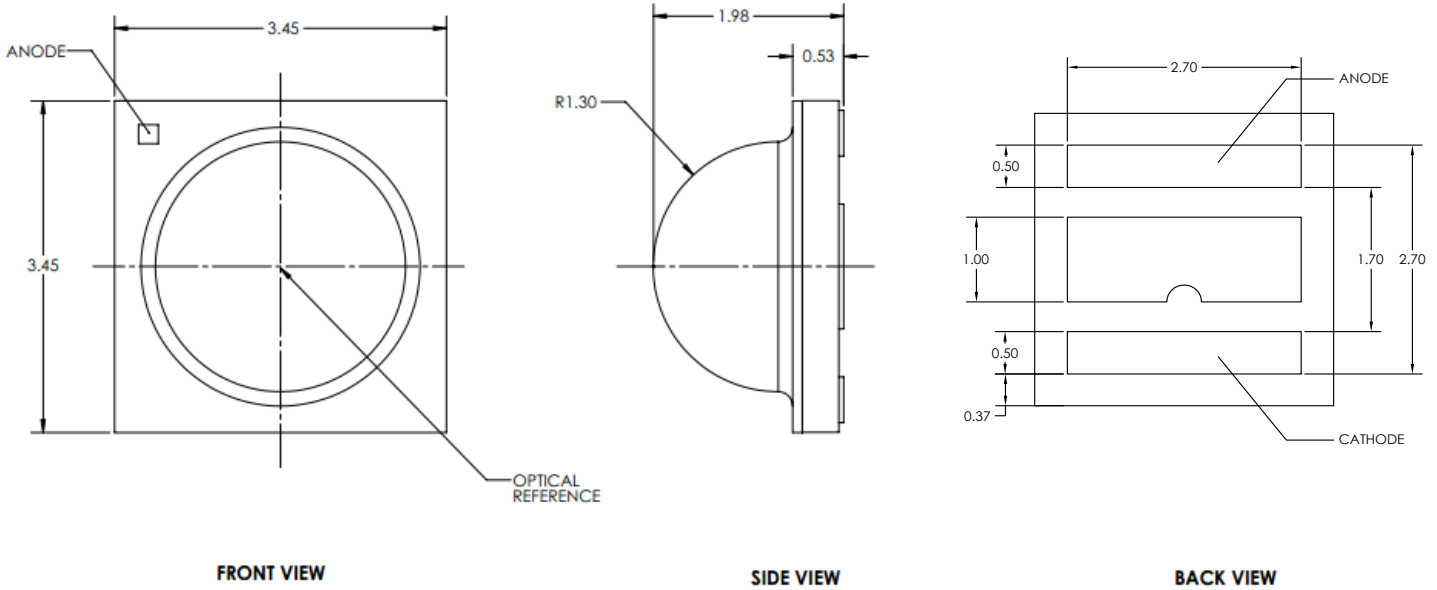

## Recommended PCB Solder Pad and Stencil Pattern<sup>1</sup>

### B120 Package Configuration

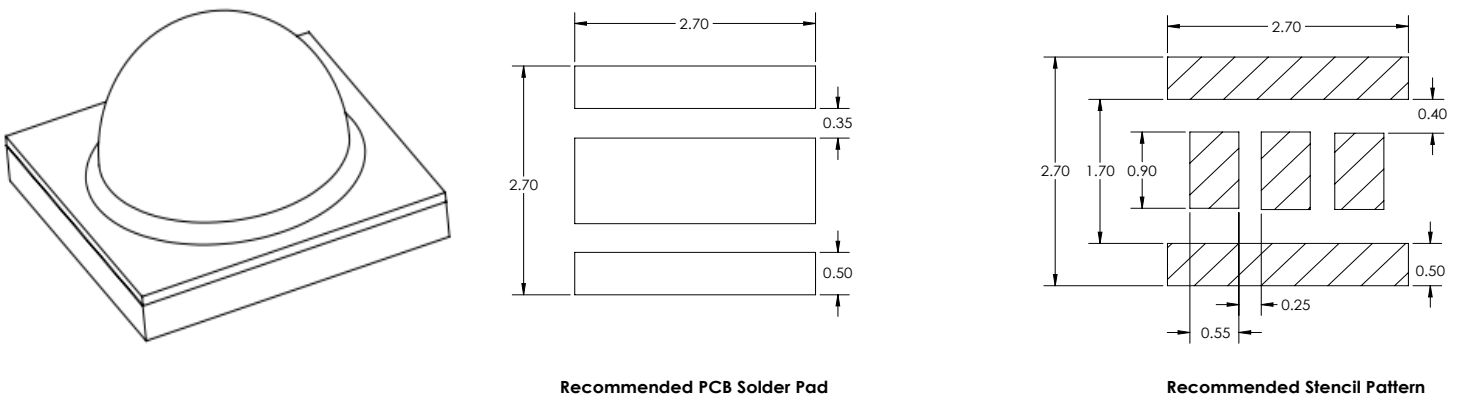

Note 1: Dimensions are in millimeters +/- 0.13 mm

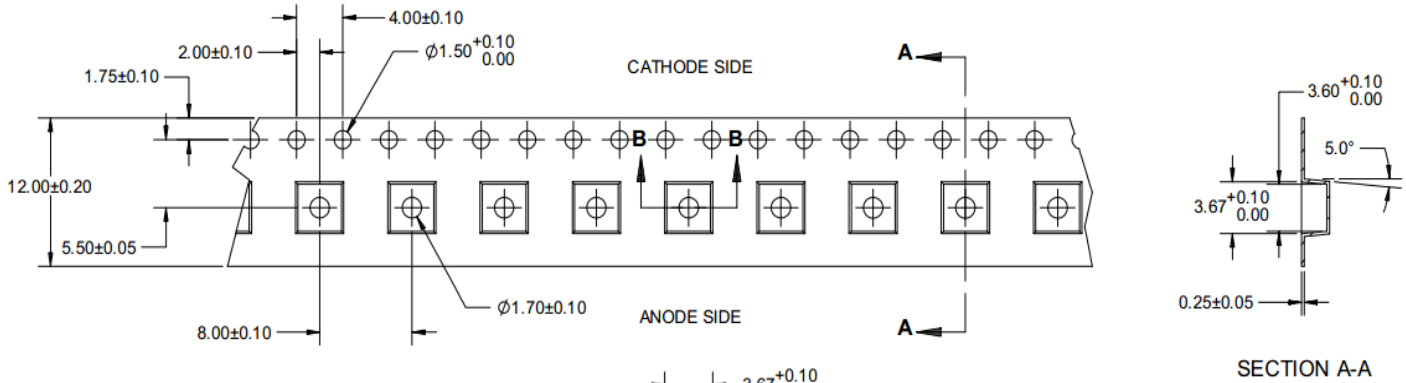
**Tape and Reel - A120 and B120 Package Configurations<sup>1</sup>**

**NOTES:**

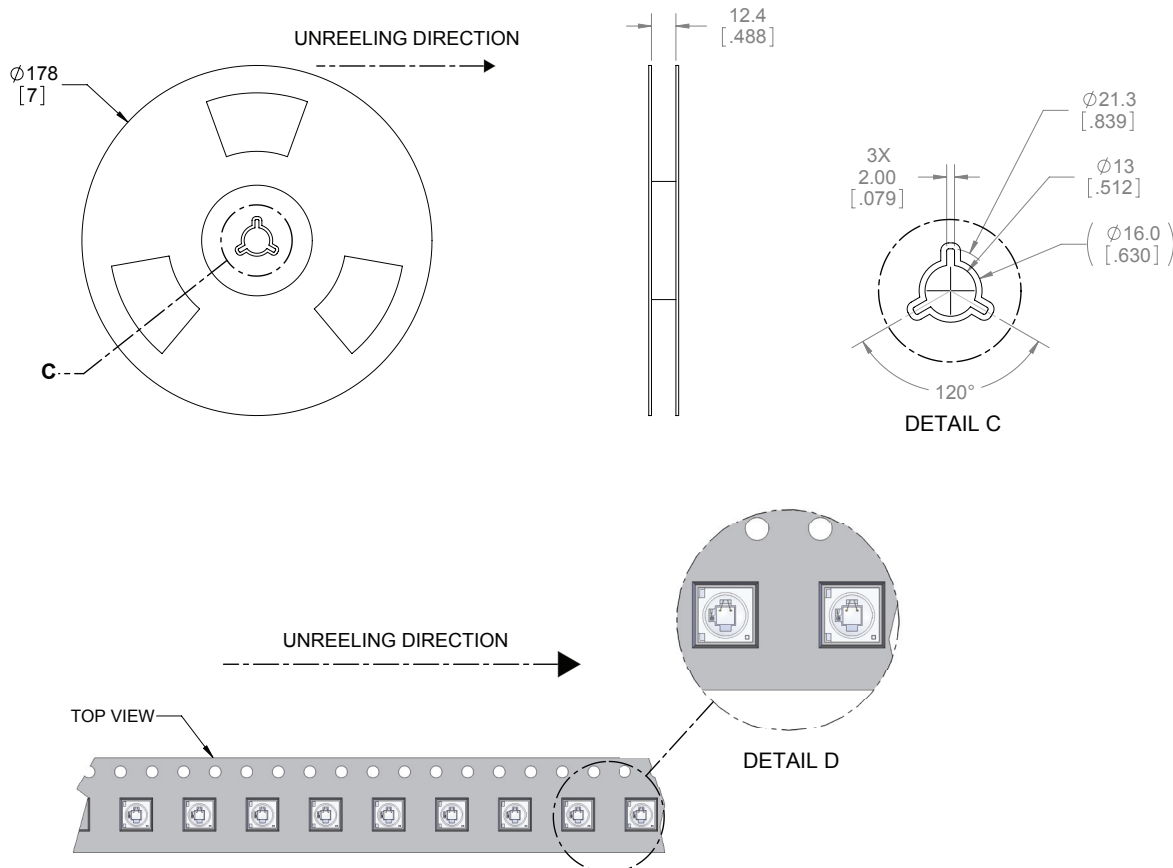
1. FINAL TAPE AND REEL PACKAGING MUST MEET THE REQUIREMENTS OF JEDEC-STD-033, LEVEL 2A.
2. LEAVE 304.8 mm [12.00 in] OF TYPE EMPTY FOR LEAD IN (38 EMPTY POCKETS)
3. LEAVE 457.2 mm [18.00 in] OF TYPE EMPTY FOR TRAILER (57 EMPTY POCKETS)
4. MUST COMPLY TO EIA-481-C-2003
5. EACH REEL CONTAINS 1,000 UNITS



Note 1: Dimensions are in millimeters



### Reel Packaging

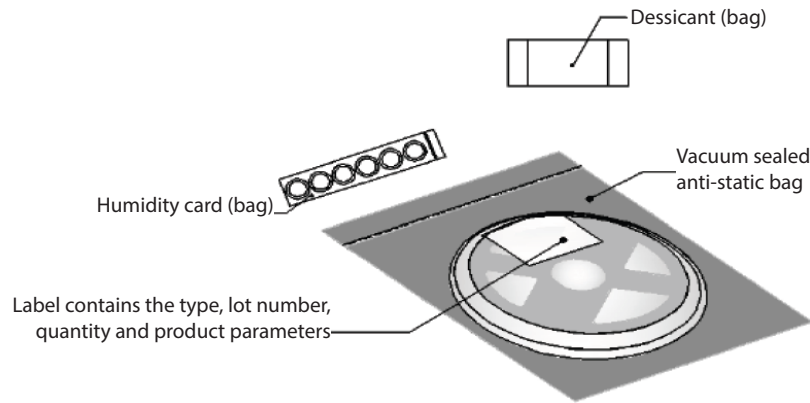

### Reel Label

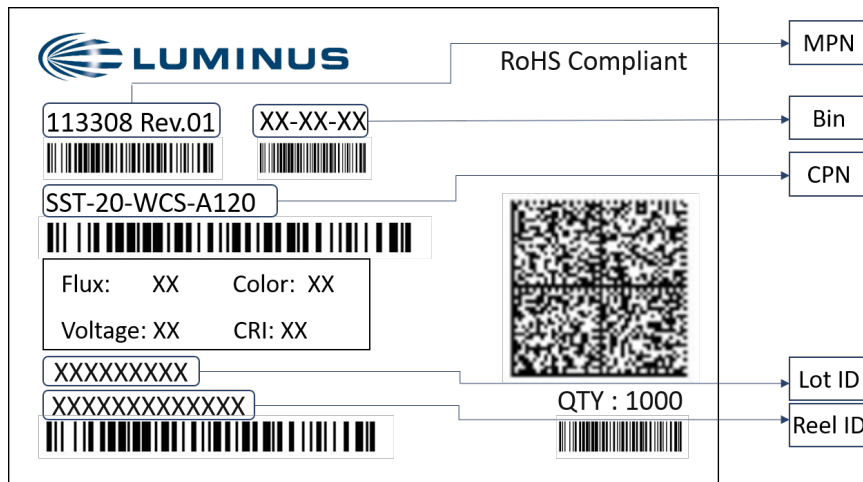

#### Label Fields:

- CPN: Luminus ordering part number
- MPN: For Luminus internal use
- Qty: On reel
- Flux: Bin as defined on page 3
- Voltage: Bin as defined on page 3
- Color: Bin as defined on page 4
- Mfg Info: For Luminus internal use

### Shipping Label

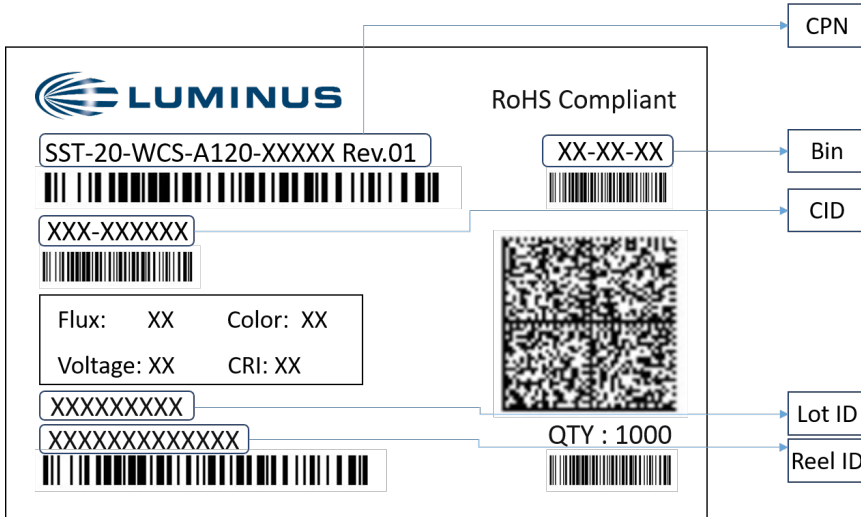

#### Label Fields:

- CPN: Luminus ordering part number
- CID: Customer ID
- Qty: On reel
- Flux: Bin as defined on page 3
- Voltage: Bin as defined on page 3
- Color: Bin as defined on page 4

### Box Packaging Information

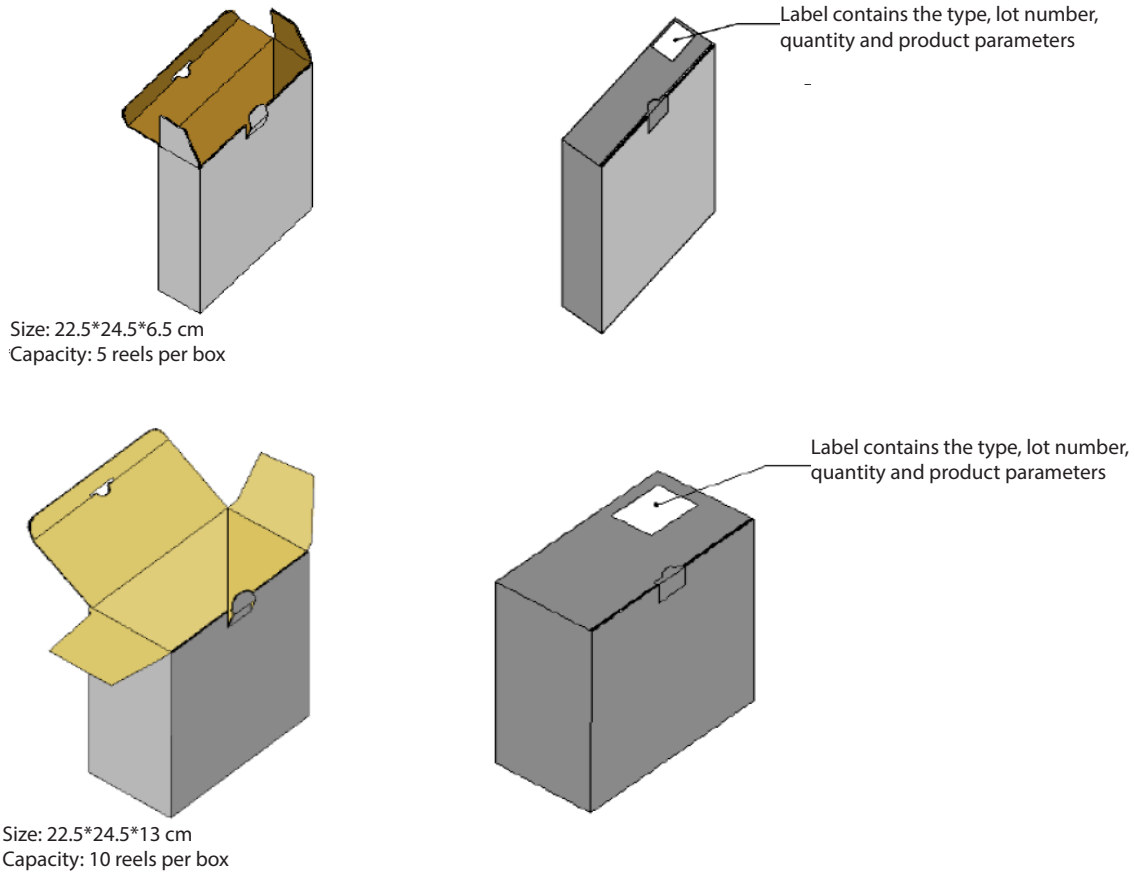

### History of Changes

| Revision | Date      | Description of Change   |
|----------|-----------|---|
| 01       | 9/17/2017 | Initial data sheet. Includes SST-20-WCS-A130 and SST-20-WCS-B130 products.  |
| 02       | 1/8/2018  | - Change binning current to 1.5 A. Updated calculated values and characterization plot accordingly.<br>- Added Photosynthetic Photon Flux and Photosynthetic Photon Flux Efficacy at 350 mA.<br>- Editorial and general parametric updates. |
| 03       | 3/2/2018  | - Remove "Preliminary".<br>- Editorial corrections across the document.   |
| 04       | 5/4/2018  | - Updated typical flux, Vf and lm/W.<br>- Added new color points: 5000K and 5700K (Preliminary status).<br>- Added CRI code definitions.<br>- Added shipping label & label description.   |
| 05       | 6/4/2018  | - Updated 5000K, 5700K, 7500K min. flux bin, Radiometric Flux, Photosynthetic Photon Flux, Photosynthetic Photon Flux Efficacy.<br>- Remove the mark of "Optical Reference".  |
| 06       | 3/25/2019 | - Updated the graph of typical relative radiant power.  |
| 07       | 3/23/2020 | - Updated ordering code and other information.  |
| 08       | 3/26/2020 | - Added flux bin.   |

The products, their specifications and other information appearing in this document are subject to change by Luminus Devices without notice. Luminus Devices assumes no liability for errors that may appear in this document, and no liability otherwise arising from the application or use of the product or information contained herein. None of the information provided herein should be considered to be a representation of the fitness or suitability of the product for any particular application or as any other form of warranty. Luminus Devices' product warranties are limited to only such warranties as accompany a purchase contract or purchase order for such products. Nothing herein is to be construed as constituting an additional warranty. No information contained in this publication may be considered as a waiver by Luminus Devices of any intellectual property rights that Luminus Devices may have in such information.

This product is protected by U.S. Patents 6,831,302; 7,074,631; 7,083,993; 7,084,434; 7,098,589; 7,105,861; 7,138,666; 7,166,870; 7,166,871; 7,170,100; 7,196,354; 7,211,831; 7,262,550; 7,274,043; 7,301,271; 7,341,880; 7,344,903; 7,345,416; 7,348,603; 7,388,233; 7,391,059 Patents Pending in the U.S. and other countries.

Компания «Океан Электроники» предлагает заключение долгосрочных отношений при поставках импортных электронных компонентов на взаимовыгодных условиях!

Наши преимущества:

- Поставка оригинальных импортных электронных компонентов напрямую с производств Америки, Европы и Азии, а так же с крупнейших складов мира;
- Широкая линейка поставок активных и пассивных импортных электронных компонентов (более 30 млн. наименований);
- Поставка сложных, дефицитных, либо снятых с производства позиций;
- Оперативные сроки поставки под заказ (от 5 рабочих дней);
- Экспресс доставка в любую точку России;
- Помощь Конструкторского Отдела и консультации квалифицированных инженеров;
- Техническая поддержка проекта, помощь в подборе аналогов, поставка прототипов;
- Поставка электронных компонентов под контролем ВП;
- Система менеджмента качества сертифицирована по Международному стандарту ISO 9001;
- При необходимости вся продукция военного и аэрокосмического назначения проходит испытания и сертификацию в лаборатории (по согласованию с заказчиком);
- Поставка специализированных компонентов военного и аэрокосмического уровня качества (Xilinx, Altera, Analog Devices, Intersil, Interpoint, Microsemi, Actel, Aeroflex, Peregrine, VPT, Syfer, Eurofarad, Texas Instruments, MS Kennedy, Miteq, Cobham, E2V, MA-COM, Hittite, Mini-Circuits, General Dynamics и др.);

Компания «Океан Электроники» является официальным дистрибьютором и эксклюзивным представителем в России одного из крупнейших производителей разъемов военного и аэрокосмического назначения «**JONHON**», а так же официальным дистрибьютором и эксклюзивным представителем в России производителя высокотехнологичных и надежных решений для передачи СВЧ сигналов «**FORSTAR**».



**JONHON**

«**JONHON**» (основан в 1970 г.)

Разъемы специального, военного и аэрокосмического назначения:

(Применяются в военной, авиационной, аэрокосмической, морской, железнодорожной, горно- и нефтедобывающей отраслях промышленности)

«**FORSTAR**» (основан в 1998 г.)

ВЧ соединители, коаксиальные кабели, кабельные сборки и микроволновые компоненты:

(Применяются в телекоммуникациях гражданского и специального назначения, в средствах связи, РЛС, а так же военной, авиационной и аэрокосмической отраслях промышленности).



Телефон: 8 (812) 309-75-97 (многоканальный)

Факс: 8 (812) 320-03-32

Электронная почта: [ocean@oceanchips.ru](mailto:ocean@oceanchips.ru)

Web: <http://oceanchips.ru/>

Адрес: 198099, г. Санкт-Петербург, ул. Калинина, д. 2, корп. 4, лит. А