


## Your Search for Proximity Sensors Starts with the World-leading Performance and Quality of the E2E

- Standard Sensors for detecting ferrous metals.
- Wide array of variations. Ideal for a variety of applications.
- Models with different frequencies are also available to prevent mutual interference.
- Superior environment resistance with standard cable made of oil-resistant PVC and sensing surface made of material that resists cutting oil.
- Useful to help prevent disconnection. Cable protector provided as a standard feature.



 Be sure to read *Safety Precautions* on page 27.

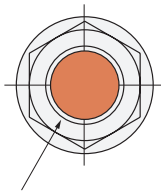
\*1: No AC/DC 2-wire models or AC 2-wire M8 models are compliant.

\*2: Attach three ferrite clamps to the cable of the E2E-X3□□ and E2E-X8MD□. (Refer to information on TDK catalog number ZCAT2035-0930A.)

## Features

### 2-Wire Models

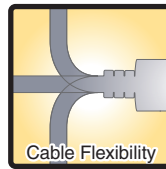
Pre-wired Models with Oil-resistant Reinforced PUR Cables Added to the Lineup and Easy Differentiation with Orange Head



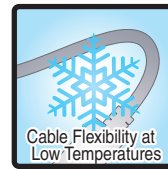
Differentiation from standard models: Orange Head



Oil Resistance (Insulation service life): twice or three times that of oil-resistant vinyl chloride

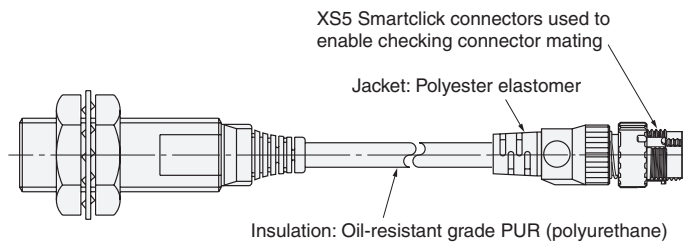
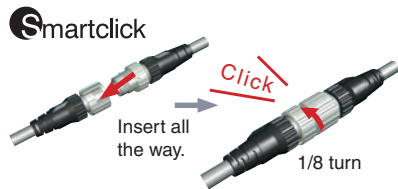


Cable Flexibility: approximately twice that of vinyl chloride cables



More Flexibility at -40°C

Lineup includes models with Smartclick pre-wired connectors for fast connection.



---

**Lineup includes models with self-diagnostic output to provide notification of failures and unstable detection conditions, such as coil burnout.**

- Contributes to preventive maintenance to keep the line from stopping.

**Reduced wiring, fewer resources, and low power consumption contribute to environmentalism.**

- Wiring work and amount of copper wire used reduced to two thirds of that required for 3-wire models.
- Current consumption drastically reduced to less than 10% (when a DC 2-wire model is compared with a DC 3-wire model).

### 3-Wire Models

**Lineup includes models with small diameter (3 dia., 4 dia., 5.4 dia., M5)**

- All small-diameter models use sealed construction. Operation is stable even when the Sensor is mounted in a small space or embedded in metal.
- Bright indicators enable easily checking the installation condition.



**Wide range of ambient operating temperatures:  $-40^{\circ}\text{C}$  to  $85^{\circ}\text{C}$  (M8 to M30 models)**

- Wide range of ambient operating temperatures also for small-diameter models:  $-25^{\circ}\text{C}$  to  $70^{\circ}\text{C}$
- Suitable for low-temperature and high-temperature applications, which are troublesome for photoelectric sensors.

**Lineup includes models with flexible cable (4-dia. to M30 models)**

- Reduced risk of disconnection in applications with moving parts.

## Models Listed by E2E Type

●: Standard Models, ▲: Different frequency, □: Self-diagnosis, ■: Different frequency and self-diagnosis, ---: Not listed

### 2-Wire Models

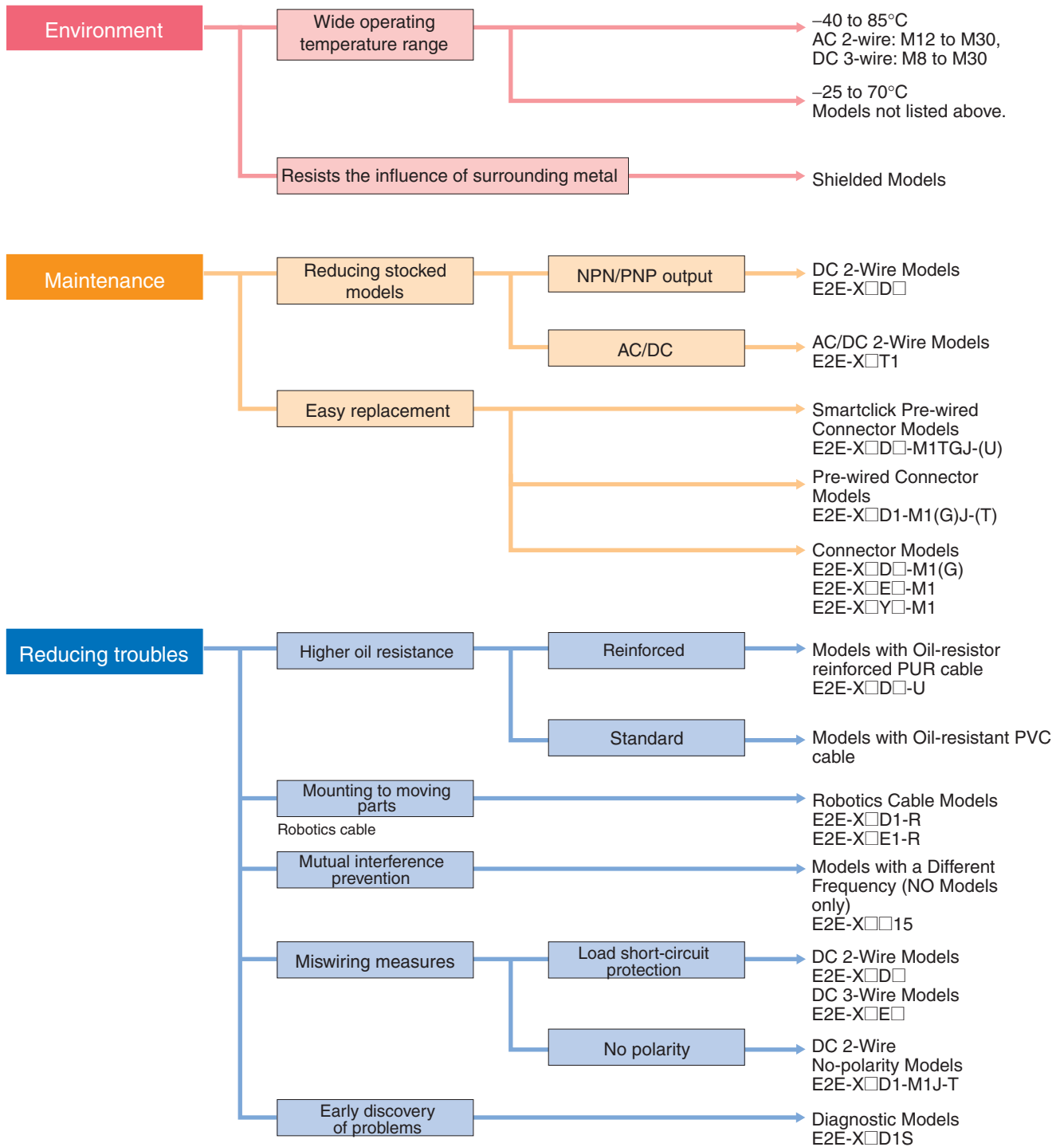
Power supply	Shielding	Size and sensing distance	Polarity	Operation mode	Oil-resistant reinforced PUR cable		Standard cable and flexible cable (cable material: oil-resistant PVC)/Connector models							Page			
					M12 pre-wired smartclick connector models	Pre-wired model with 2-m cable	M12 pre-wired smartclick connector models	Pre-wired model with standard 2-m cable	Pre-wired model with flexible 2-m cable	Pre-wired model with standard 5-m cable	M12 connector (IEC pin arrangement)	M12 standard pre-wired connector models	M8 connector	M12 connector (old pin arrangement)	Ordering Information	Dimensions reference chart	
DC	Shielded	M8 2 m	Yes	NO	●	●	●	●	●	●	●	---	●	●	Refer to page 7.	Refer to page 29.	
				NC	●	●	---	●	---	●	●	---	●	●			
		M12 3 mm	Yes	NO	●	●	●	●▲■	●	●	●▲□	●	---	●			Refer to Models with Self-diagnostic Output on page 8.
				NC	●	●	---	●	---	●	●	---	●	●			
		M18 7 mm	No	NO	---	---	---	---	---	---	---	●	---	---			Refer to Models with conventional connector pin assignments on page 9.
				NC	---	---	---	---	---	---	---	●	---	---			
	M30 10 mm	Yes	NO	●	●	●	●▲■	●	●	●▲□	●	---	●	Refer to Models with conventional connector pin assignments on page 9.			
			NC	●	●	---	●	---	---	●	●	---	●				
	M30 10 mm	No	NO	---	---	---	---	---	---	---	---	●	---	---			
			NC	---	---	---	---	---	---	---	---	●	---	---			
	Unshielded	M8 4 mm	Yes	NO	---	---	---	●	●	●	●	---	●	●	Refer to page 8.		
				NC	---	---	---	●	---	---	●	---	●	●			
		M12 8 mm		NO	---	---	●	●▲■	●	●	●▲□	●	---	●	Refer to Models with Self-diagnostic Output or Models with conventional connector pin assignments on page 9.		
				NC	---	---	---	●	---	---	●	---	●	●			
		M18 14 mm		NO	---	---	●	●▲■	●	●	●▲□	●	---	●			Refer to Models with conventional connector pin assignments on page 9.
				NC	---	---	---	●	---	---	●	---	●	●			
	M30 20 mm	NO	---	---	●	●▲■	●	●	●▲□	●	---	●	Refer to Models with conventional connector pin assignments on page 9.				
		NC	---	---	---	●	---	---	●	---	●	●					
AC	Shielded	M8 1.5 mm	---	NO	---	---	---	●	---	---	---	---	---	Refer to page 10.			
				NC	---	---	---	●	---	---	---	---	---				
		M12 2 mm		NO	---	---	---	●▲	---	●	●	---	---		---		
				NC	---	---	---	●	---	---	●	---	---		---		
		M18 5 mm		NO	---	---	---	●▲	---	●	●	---	---		---		
				NC	---	---	---	●	---	---	●	---	---		---		
	M30 10 mm	NO		---	---	---	●▲	---	●	●	---	---	---				
		NC		---	---	---	●	---	---	●	---	---	---				
	Unshielded	M8 2 mm		NO	---	---	---	●	---	---	---	---	---		---		
				NC	---	---	---	●	---	---	---	---	---		---		
		M12 5 mm		NO	---	---	---	●▲	---	●	●	---	---		---		
				NC	---	---	---	●	---	---	●	---	---		---		
M18 10 mm		NO	---	---	---	●▲	---	●	●	---	---	---					
		NC	---	---	---	●	---	---	●	---	---	---					
M30 18 mm	NO	---	---	---	●▲	---	●	●	---	---	---						
	NC	---	---	---	●	---	---	●	---	---	---						
AC/DC	Shielded	M12 2 mm	NO	---	---	---	●	---	---	---	---	---	---				
			NC	---	---	---	---	---	---	---	---	---	---				
		M18 5 mm	NO	---	---	---	●	---	●	---	---	---	---				
			NC	---	---	---	---	---	---	---	---	---	---				
		M30 10 mm	NO	---	---	---	●	---	---	---	---	---	---				
			NC	---	---	---	---	---	---	---	---	---	---				

●: Standard Models, ▲: Different frequency, ---: Not listed

3-Wire Models

Power supply	Shielding	Size and sensing distance	Polarity	Operation mode	Oil-resistant reinforced PUR cable		Standard cable and flexible cable (cable material: oil-resistant PVC)/Connector models								Page	
					M12 pre-wired smartclick connector models	Pre-wired model with 2-m cable	M12 pre-wired smartclick connector models	Pre-wired model with standard 2-m cable	Pre-wired model with flexible 2-m cable	Pre-wired model with standard 5-m cable	M12 connector (IEC pin arrangement)	M12 standard pre-wired connector models	M8 connector	e-CON pre-wired connector models	Ordering Information	Dimensions reference chart
					DC NPN	Shielded	3 dia. 0.6 mm	Yes	NO	---	---	---	●	---	---	---
NC	---	---	---	●	---				---	---	---	---	---	---		
4 dia. 0.8 mm	NO	---	---	---	●		●		●	---	---	---	---	---		
	NC	---	---	---	●		---		---	---	---	---	---	---		
M5 1 mm	NO	---	---	---	●		●		●	---	---	---	---	---		
	NC	---	---	---	●		---		---	---	---	---	---	---		
5.4 dia. 1 mm	NO	---	---	---	●		●		●	---	---	---	---	---		
	NC	---	---	---	●		---		---	---	---	---	---	---		
M8 1.5mm	NO	---	---	---	●		●		●	●	---	●	---	---		
	NC	---	---	---	●		---		---	---	---	●	---	---		
M12 2 mm	NO	---	---	---	●▲		●		●	●	●	---	---	●		
	NC	---	---	---	●		---		---	---	---	●	---	---		
M18 5 mm	NO	---	---	---	●▲		●		●	●	●	---	---	●		
	NC	---	---	---	●		---		---	---	---	●	---	---		
M30 10 mm	NO	---	---	---	●▲	●	●	●	●	---	---	●				
	NC	---	---	---	●	---	---	---	---	●	---	---				
Unshielded	M8 2 mm	NO	---	---	---	●	●	---	---	●	---	●	---			
		NC	---	---	---	●	---	---	---	●	---	●	---			
	M12 5 mm	NO	---	---	---	●▲	●	●	●	●	---	---	●			
		NC	---	---	---	●	---	---	---	---	●	---	---			
	M18 10 mm	NO	---	---	---	●▲	●	●	●	●	---	---	●			
		NC	---	---	---	●	---	---	---	---	●	---	---			
M30 18 mm	NO	---	---	---	●▲	●	●	●	●	---	---	●				
	NC	---	---	---	●	---	---	---	---	●	---	---				
DC PNP	Shielded	3 dia. 0.6 mm	Yes	NO	---	---	---	●	---	---	---	---	---	---	Refer to page 11.	
				NC	---	---	---	●	---	---	---	---	---	---		
		4 dia. 0.8 mm		NO	---	---	---	●	●	---	---	---	---	---		
				NC	---	---	---	●	---	---	---	---	---	---		
		M5 1 mm		NO	---	---	---	●	●	---	---	---	---	---		
				NC	---	---	---	●	---	---	---	---	---	---		
		5.4 dia. 1 mm		NO	---	---	---	●	---	---	---	---	---	---		
				NC	---	---	---	●	---	---	---	---	---	---		
		M8 1.5mm		NO	---	---	---	●	●	●	●	●	---	●		---
				NC	---	---	---	●	---	---	---	---	●	---		---
		M12 2 mm		NO	---	---	---	●▲	●	●	●	●	---	---		---
				NC	---	---	---	●	---	---	---	---	●	---		---
	M18 5 mm	NO		---	---	---	●▲	●	●	●	●	---	---	---		
		NC		---	---	---	●	---	---	---	---	●	---	---		
	M30 10 mm	NO		---	---	---	●	●	---	---	---	●	---	---		
		NC		---	---	---	●	---	---	---	---	●	---	---		
	Unshielded	M8 2 mm		NO	---	---	---	●	●	---	---	●	---	●		---
				NC	---	---	---	●	---	---	---	●	---	●		---
M12 5 mm		NO	---	---	---	●	●	---	---	●	---	---	---			
		NC	---	---	---	●	---	---	---	---	●	---	---			
M18 10 mm		NO	---	---	---	●	●	---	---	---	●	---	---			
		NC	---	---	---	●	---	---	---	---	●	---	---			
M30 18 mm	NO	---	---	---	●	●	---	---	---	●	---	---				
	NC	---	---	---	●	---	---	---	---	●	---	---				

## E2E Guide to Selection by Purpose



Note: Refer to *Models Not Listed in this Catalog* for Long Body Models, Transmission Couplers, and Power Couplers.

## E2E Model Number Legend

E2E- ① ② ③ ④ ⑤ ⑥ ⑦ - ⑧ ⑨ - ⑩ - ⑪ - ⑫ ⑬

No.	Classification	Code	Meaning	Remarks
①	Appearance	C	Cylindrical (not threaded)	
		X	Cylindrical (threaded)	
②	Sensing distance	Number	Sensing distance (Unit: mm)	Example: R6: 0.6 mm 1R5: 1.5 mm
		R	Indication of decimal point	
③	Shielding	Blank	Shielded Models	
		M	Unshielded Models	
④	Power supply and output specifications	B	DC 3-wire PNP open-collector output	Whether D models have polarity is defined by number ⑩.
		C	DC 3-wire NPN open-collector output	
		D	DC 2-wire polarity/no polarity	
		E	DC 3-wire NPN collector load built-in output	
		F	DC 3-wire PNP collector load built-in output	
		T	AC/DC 2-wire	
		Y	AC 2-wire	
⑤	Form of output switching element	1	Normally open (NO)	
		2	Normally closed (NC)	
⑥	Oscillation frequency type	Blank	Standard frequency	Used to prevent mutual interference.
		5	Different frequency	
⑦	Self-diagnosis	Blank	No	
		5	Yes	
⑧	Connection method	Blank	Pre-wired	These models are also available with e-CON connectors (0.3-m cable). Add “-ECON” to the end of the model number.
		M1	M12-size metal connector	
		M3	M8-size metal connector	
⑨	Connector specifications	Blank	Connector Models DC 3-wire and AC 2-wire, DC 2-wire with self-diagnosis output, DC 2-wire with old pin arrangement (polarity)	
		G	Connector Models DC 2-wire with IEC pin arrangement (polarity)	
		J	Pre-wired Connector Models DC 3-wire and AC 2-wire, DC 2-wire with IEC pin arrangement (polarity), DC 3-wire and AC 2-wire, DC 2-wire with self-diagnosis output, DC 2-wire with old pin arrangement (polarity)	
		GJ	Pre-wired Connector Models DC 2-wire with IEC pin arrangement (polarity)	
		TJ	Pre-wired Smartclick Connector Models DC 2-wire with IEC pin arrangement (no polarity)	
		TGJ	Pre-wired Smartclick Connector Models DC 2-wire with IEC pin arrangement (polarity)	
⑩	DC 2-wire polarity	Blank	Polarity	
		T	No polarity	
⑪	Cable specifications	Blank	Standard PVC cable (oil resistant)	
		R	Flexible PVC cable (oil resistant)	
		U	Polyurethane cable (oil resistant and reinforced)	
⑫	New model	N	New model (Applies only to DC 2-wire pre-wired and shielded models.)	This is blank if the cable specification in number ⑪ is R or U.
⑬	Cable length	Letter M	Cable length (Unit: m) (Applicable to Pre-wired Models and Pre-wired Connector Models.)	Example: 2M 0.3M

Note: The purpose of this model number legend is to provide understanding of the meaning of specifications from the model number. Models are not available for all combinations of code numbers. Ask your OMRON representative if you require a customized model.

## Ordering Information

### 2-Wire Models

Shielded DC 2-wire Models with No Self-diagnostic Output [Refer to *Dimensions* on page 29.]



Appearance	Sensing distance		Connection method	Cable specifications	Polarity	Operation mode	Pin arrangement	Applicable connector code *4	Model						
M8	2 mm		M12 Pre-wired Smart-click Connector Models (0.3m)	PUR (increased oil-resistant)	Yes	NO	1: +V, 4: 0 V	H	E2E-X2D1-M1TGJ-U 0.3M						
				PVC (oil-resistant)		NC	1: +V, 2: 0 V		E2E-X2D2-M1TGJ-U 0.3M						
			Pre-wired Models (2 m)	PUR (increased oil-resistant)				NO	---	---	E2E-X2D1-U 2M				
				PVC (oil-resistant)				NC			E2E-X2D2-U 2M				
				M12 Connector Models				---			NO	1: +V, 4: 0 V	A	E2E-X2D1-M1G	
								---			NC	1: +V, 2: 0 V	D	E2E-X2D2-M1G	
			M8 Connector Models	---				NO	---	I	E2E-X2D1-M3G				
				---				NC			1: +V, 2: 0 V	E2E-X2D2-M3G			
			M12	3 mm			M12 Pre-wired Smart-click Connector Models (0.3m)	PUR (increased oil-resistant)	Yes	NO	1: +V, 4: 0 V	H	E2E-X3D1-M1TGJ-U 0.3M		
								PVC (oil-resistant)		NC	1: +V, 2: 0 V		E2E-X3D2-M1TGJ-U 0.3M		
							Pre-wired Models (2 m)	PUR (increased oil-resistant)				NO	---	---	E2E-X3D1-U 2M
								PVC (oil-resistant)				NC			E2E-X3D2-U 2M
M12 Connector Models	---	NO			1: +V, 4: 0 V			A				E2E-X3D1-M1G *1			
	---	NC			1: +V, 2: 0 V			D				E2E-X3D2-M1G			
M12 Standard Pre-wired Connector Models (0.3 m) *6	PVC (oil-resistant)						Yes	NO		1: +V, 4: 0 V	A	E2E-X3D1-M1GJ 0.3M			
							No *5	NO		(3, 4): (+V, 0 V)	C	E2E-X3D1-M1J-T 0.3M			
								NC		(1, 2): (+V, 0 V)	D	---			
								M18		7 mm		M12 Pre-wired Smart-click Connector Models (0.3m)	PUR (increased oil-resistant)	Yes	NO
PVC (oil-resistant)	NC	1: +V, 2: 0 V			E2E-X7D2-M1TGJ-U 0.3M										
Pre-wired Models (2 m)	PUR (increased oil-resistant)						NO					---	---		E2E-X7D1-U 2M
	PVC (oil-resistant)		NC	E2E-X7D2-U 2M											
	M12 Connector Models		---	NO		1: +V, 4: 0 V	A		E2E-X7D1-M1G *1						
			---	NC		1: +V, 2: 0 V	D		E2E-X7D2-M1G						
M12 Standard Pre-wired Connector Models (0.3 m) *6	PVC (oil-resistant)			Yes	NO	1: +V, 4: 0 V	A		E2E-X7D1-M1GJ 0.3M						
				No *5	NO	(3, 4): (+V, 0 V)	C		E2E-X7D1-M1J-T 0.3M						
					NC	(1, 2): (+V, 0 V)	D		E2E-X7D2-M1J-T 0.3M						
					M30	10 mm			M12 Pre-wired Smart-click Connector Models (0.3m)			PUR (increased oil-resistant)	Yes		NO
PVC (oil-resistant)	NC	1: +V, 2: 0 V	E2E-X10D2-M1TGJ-U 0.3M												
Pre-wired Models (2 m)	PUR (increased oil-resistant)			NO					---			---			E2E-X10D1-U 2M
	PVC (oil-resistant)			NC				E2E-X10D2-U 2M							
	M12 Connector Models			---				NO		1: +V, 4: 0 V	A			E2E-X10D1-M1G *1	
				---				NC		1: +V, 2: 0 V	D			E2E-X10D2-M1G	
M12 Standard Pre-wired Connector Models (0.3 m) *6	PVC (oil-resistant)			Yes				NO	1: +V, 4: 0 V	A	E2E-X10D1-M1GJ 0.3M				
				No *5				NO	(3, 4): (+V, 0 V)	C	E2E-X10D1-M1J-T 0.3M				
								NC	(1, 2): (+V, 0 V)	D	E2E-X10D2-M1J-T 0.3M				

\*1. Models with different frequencies are also available. The model number is E2E-X □D15 (example: E2E-X3D15-N 2M).

\*2. Models with a flexible cable are also available. Add "-R" rather than "-N" to the end of the model number (example: E2E-X2D1-R 2M).

\*3. The standard stock includes models with a cable length of 5 m. Specify the cable length at the end of the model number. (Example: E2E-X3D1-N 5M)

\*4. Refer to page 24 for details.

\*5. The residual voltage for models without polarity is 5 V, so use caution concerning the connection load interface conditions (e.g., PLC ON voltage). Refer to page 28.

\*6. The standard cable length is 300 mm. Cables with a length of 500 mm and 1 m can also be manufactured.

## 2-Wire Models

Unshielded DC 2-Wire Models with No Self-diagnosis Output [Refer to *Dimensions* on page 29.]

Appearance	Sensing distance		Connection method	Cable specifications	Polarity	Operation mode	Pin arrangement	Applicable connector code *4	Model		
M8	4 mm		Pre-wired Models (2 m)	PVC (oil-resistant)	Yes	NO	---	---	E2E-X4MD1 2M *2*3		
			M12 Connector Models	---		NC			E2E-X4MD2 2M		
			M8 Connector Models	---		NO			1: +V, 4: 0 V	A	E2E-X4MD1 2M
						NC			1: +V, 2: 0 V	D	E2E-X4MD2-M1G
						NO			1: +V, 4: 0 V	I	E2E-X4MD1-M3G
						NC			1: +V, 2: 0 V		E2E-X4MD2-M3G
M12	8 mm		12M Pre-wired Smart-click Connector Models (0.3m)	PVC (oil-resistant)		NO	1: +V, 4: 0 V	G	E2E-X8MD1-M1TGJ 0.3M		
			Pre-wired Models (2 m)	PVC (oil-resistant)		NO	---	---	E2E-X8MD1 2M *1*2*3		
			M12 Connector Models	---		NC			E2E-X8MD2 2M		
			M12 Standard Pre-wired Connector Models (0.3 m)	PVC (oil-resistant)		NO	1: +V, 4: 0 V	A	E2E-X8MD1-M1G *1		
						NC	1: +V, 2: 0 V	D	E2E-X8MD2-M1G		
						NO	1: +V, 4: 0 V	A	E2E-X8MD1-M1GJ 0.3M		
					NC	1: +V, 2: 0 V	D	---			
			M18	14 mm		12M Pre-wired Smart-click Connector Models (0.3m)	PVC (oil-resistant)	NO	1: +V, 4: 0 V	G	E2E-X14MD1-M1TGJ 0.3M
						Pre-wired Models (2 m)	PVC (oil-resistant)	NO	---	---	E2E-X14MD1 2M *1*2*3
						M12 Connector Models	---	NC			E2E-X14MD2 2M
M12 Standard Pre-wired Connector Models (0.3 m)	PVC (oil-resistant)	NO				1: +V, 4: 0 V	A	E2E-X14MD1-M1G *1			
		NC				1: +V, 2: 0 V	D	E2E-X14MD2-M1G			
		NO				1: +V, 4: 0 V	A	E2E-X14MD1-M1GJ 0.3M			
		NC				1: +V, 2: 0 V	D	E2E-X14MD2-M1GJ 0.3M			
M30	20 mm					12M Pre-wired Smart-click Connector Models (0.3m)	PVC (oil-resistant)	NO	1: +V, 4: 0 V	G	E2E-X20MD1-M1TGJ 0.3M
						Pre-wired Models (2 m)	PVC (oil-resistant)	NO	---	---	E2E-X20MD1 2M *1*2*3
						M12 Connector Models	---	NC			E2E-X20MD2 2M
			M12 Standard Pre-wired Connector Models (0.3 m)	PVC (oil-resistant)	NO	1: +V, 4: 0 V	A	E2E-X20MD1-M1G *1			
					NC	1: +V, 2: 0 V	D	E2E-X20MD2-M1G			
					NO	1: +V, 4: 0 V	A	E2E-X20MD1-M1GJ 0.3M			
					NC	1: +V, 2: 0 V	D	---			

\*1. Models with different frequencies are also available. The model number is E2E-X □D15 (example: E2E-X8MD15 2M).

\*2. Models with a flexible cable are also available. Add -R to the end of the model number. (example: E2E-X4MD1-R 2M).

\*3. The standard stock includes models with a cable length of 5 m. Specify the cable length at the end of the model number. (Example: E2E-X4MD1 5M)

\*4. Refer to page 24 for details.

Shielded DC 2-Wire Models with Self-diagnosis Output [Refer to *Dimensions* on page 29.]

Appearance	Sensing distance		Connection method	Cable specifications	Polarity	Operation mode	Pin arrangement	Applicable connector code *2	Model
M12	3 mm		Pre-wired Models (2 m)	PVC (oil-resistant)	Yes	NO	---	---	E2E-X3D1S 2M *1
			M12 Connector Models	---			2: +V and diagnostic output 3: 0 V 4: +V and control output	D	E2E-X3D1S-M1
M18	7 mm		Pre-wired Models (2 m)	PVC (oil-resistant)			---	---	E2E-X7D1S 2M *1
			M12 Connector Models	---			2: +V and diagnostic output 3: 0 V 4: +V and control output	D	E2E-X7D1S-M1
M30	10 mm		Pre-wired Models (2 m)	PVC (oil-resistant)			---	---	E2E-X10D1S 2M *1
			M12 Connector Models	---			2: +V and diagnostic output 3: 0 V 4: +V and control output	D	E2E-X10D1S-M1

\*1. Models with different frequencies are also available. The model number is E2E-X □D15S (example: E2E-X3D15S 2M).

\*2. Refer to page 24 for details.



**2-Wire Models**

**Unshielded DC 2-Wire Models with Self-diagnosis Output** [Refer to *Dimensions* on page 29.]



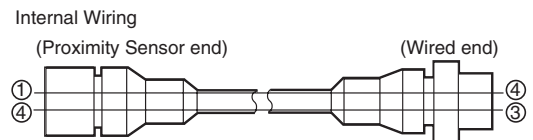
Appearance	Sensing distance		Connection method	Cable specifications	Polarity	Operation mode	Pin arrangement	Applicable connector code *2	Model	
M12	8 mm		Pre-wired Models (2 m)	PVC (oil-resistant)	Yes	NO	---	---	E2E-X8MD1S 2M *	
			M12 Connector Models	---			2: +V and diagnostic output 3: 0 V 4: +V and control output	D	E2E-X8MD1S-M1	
M18	14 mm		Pre-wired Models (2 m)	PVC (oil-resistant)			---	---	---	E2E-X14MD1S 2M *
			M12 Connector Models	---			2: +V and diagnostic output 3: 0 V 4: +V and control output	D	E2E-X14MD1S-M1	
M30	20 mm		Pre-wired Models (2 m)	PVC (oil-resistant)			---	---	---	E2E-X20MD1S 2M *
			M12 Connector Models	---			2: +V and diagnostic output 3: 0 V 4: +V and control output	D	E2E-X20MD1S-M1	

\*1. Models with different frequencies are also available. The model number is E2E-X □MD15S (example: E2E-X8MD15S 2M).  
 \*2. Refer to page 24 for details.

**Connector Pin Assignments of DC 2-Wire Models**

- The connector pin assignments of each New E2E DC 2-Wire Model conform to IEC 947-5-2 Table III. (Only DC 2-Wire Models have been changed in comparison to the previous models.)
- The following models with conventional connector pin assignments are available as well. (Only NO Models can be used.)  
 The cable at the right should also be used if the XW3A-P□45-G11 Connector Junction Box is already being used.

Cable length	Model
500 mm	XS2W-D421-BY1



Models with conventional connector pin assignments are available as well.

Appearance	Model				
	NO	Applicable connector code *	NC	Applicable connector code *	
Shielded 	M8	E2E-X2D1-M1	C	E2E-X2D2-M1	D
	M12	E2E-X3D1-M1	C	E2E-X3D2-M1	D
	M18	E2E-X7D1-M1	C	E2E-X7D2-M1	D
	M30	E2E-X10D1-M1	C	E2E-X10D2-M1	D
Unshielded 	M8	E2E-X4MD1-M1	C	E2E-X4MD2-M1	D
	M12	E2E-X8MD1-M1	C	E2E-X8MD2-M1	D
	M18	E2E-X14MD1-M1	C	E2E-X14MD2-M1	D
	M30	E2E-X20MD1-M1	C	E2E-X20MD2-M1	D

Note: Refer to page 24 for details.

## 2-Wire Models

AC 2-Wire Models Shielded Models [Refer to *Dimensions* on page 29.]

Appearance	Sensing distance		Connection method	Cable specifications	Operation mode	Pin arrangement	Applicable connector code *3	Model
M8	1.5 mm		Pre-wired Models (2 m)	PVC (oil-resistant)	NO	---	---	E2E-X1R5Y1 2M
					NC			E2E-X1R5Y2 2M
M12	2 mm		Pre-wired Models (2 m)	PVC (oil-resistant)	NO	---	---	E2E-X2Y1 2M *1*2
					NC			E2E-X2Y2 2M
			M12 Connector Models	---	NO	(3, 4): (AC, AC)	E	E2E-X2Y1-M1
					NC	(1, 2): (AC, AC)	F	E2E-X2Y2-M1
M18	5 mm		Pre-wired Models (2 m)	PVC (oil-resistant)	NO	---	---	E2E-X5Y1 2M *1*2
					NC			E2E-X5Y2 2M
			M12 Connector Models	---	NO	(3, 4): (AC, AC)	E	E2E-X5Y1-M1
					NC	(1, 2): (AC, AC)	F	E2E-X5Y2-M1
M30	10 mm		Pre-wired Models (2 m)	PVC (oil-resistant)	NO	---	---	E2E-X10Y1 2M *1*2
					NC			E2E-X10Y2 2M
			M12 Connector Models	---	NO	(3, 4): (AC, AC)	E	E2E-X10Y1-M1
					NC	(1, 2): (AC, AC)	F	E2E-X10Y2-M1

\*1. Models with different frequencies are also available. The model number is E2E-X □Y□5 (example: E2E-X5Y15 2M).

\*2. The standard stock includes models with a cable length of 5 m. Specify the cable length at the end of the model number. (Example: E2E-X2Y1 5M)

\*3. Refer to page 24 for details.

## Unshielded Models



Appearance	Sensing distance		Connection method	Cable specifications	Operation mode	Pin arrangement	Applicable connector code *3	Model
M8	2 mm		Pre-wired Models (2 m)	PVC (oil-resistant)	NO	---	---	E2E-X2MY1 2M
					NC			E2E-X2MY2 2M
M12	5 mm		Pre-wired Models (2 m)	PVC (oil-resistant)	NO	---	---	E2E-X5MY1 2M *1*2
					NC			E2E-X5MY2 2M
			M12 Connector Models	---	NO	(3, 4): (AC, AC)	E	E2E-X5MY1 2M
					NC	(1, 2): (AC, AC)	F	E2E-X5MY2-M1
M18	10 mm		Pre-wired Models (2 m)	PVC (oil-resistant)	NO	---	---	E2E-X10MY1 2M *1
					NC			E2E-X10MY2 2M
			M12 Connector Models	---	NO	(3, 4): (AC, AC)	E	E2E-X10MY1-M1
					NC	(1, 2): (AC, AC)	F	E2E-X10MY2-M1
M30	18 mm		Pre-wired Models (2 m)	PVC (oil-resistant)	NO	---	---	E2E-X18MY1 2M *1
					NC			E2E-X18MY2 2M
			M12 Connector Models	---	NO	(3, 4): (AC, AC)	E	E2E-X18MY1-M1
					NC	(1, 2): (AC, AC)	F	E2E-X18MY2-M1

\*1. Models with different frequencies are also available. The model number is E2E-X □MY□5 (example: E2E-X5MY15 2M).

\*2. The standard stock includes models with a cable length of 5 m. Specify the cable length at the end of the model number. (Example: E2E-X5MY1 5M)

\*3. Refer to page 24 for details.

AC 2-Wire Models Shielded Models [Refer to *Dimensions* on page 29.]

(There are no unshielded models.)



Appearance	Sensing distance		Connection method	Cable specifications	Operation mode	Pin arrangement	Applicable connector code *3	Model
M12	3 mm		Pre-wired Models (2 m)	PVC (oil-resistant)	NO	---	---	E2E-X3T1 2M
M18	7 mm		Pre-wired Models (2 m)	PVC (oil-resistant)		---	---	E2E-X7T1 2M *
M30	10 mm		Pre-wired Models (2 m)	PVC (oil-resistant)		---	---	E2E-X10T1 2M

Note: Not compliant with CE.

\* The standard stock includes models with a cable length of 5 m. Specify the cable length at the end of the model number. (Example: E2E-X7T1 5M)

3-Wire Models

Shielded DC 3-Wire Models [Refer to Dimensions on page 29.]



Appearance	Sensing distance		Connection method	Cable specifications	Operation mode	Pin arrangement	Applicable connector code *5	Model	
								NPN output	PNP output
3 dia.	0.6 mm		Pre-wired Models (2 m)	PVC (oil-resistant)	NO	---	---	E2E-CR6C1 2M	E2E-CR6B1 2M
					NC			E2E-CR6C2 2M	E2E-CR6B2 2M
4 dia.	0.8 mm		Pre-wired Models (2 m)	PVC (oil-resistant)	NO	---	---	E2E-CR8C1 2M *1*2	E2E-CR8B1 2M *2
					NC			E2E-CR8C2 2M	E2E-CR8B2 2M
M5	1 mm		Pre-wired Models (2 m)	PVC (oil-resistant)	NO	---	---	E2E-X1C1 2M *1*2	E2E-X1B1 2M *2
					NC			E2E-X1C2 2M	E2E-X1B2 2M
5.4 dia.	1 mm		Pre-wired Models (2 m)	PVC (oil-resistant)	NO	---	---	E2E-C1C1 2M *1*2	E2E-C1B1 2M
					NC			E2E-C1C2 2M	E2E-C1B2 2M
M8	1.5 mm		Pre-wired Models (2 m)	PVC (oil-resistant)	NO	---	---	E2E-X1R5E1 2M *1*2	E2E-X1R5F1 2M *1*2
					NC			E2E-X1R5E2 2M	E2E-X1R5F2 2M
			M12 Connector Models	---	NO	1: +V, 3: 0 V, 4: Control output	B	E2E-X1R5E1-M1	E2E-X1R5F1-M1
					NC	1: +V, 3: 0 V, 2: Control output	D	E2E-X1R5E2-M1	E2E-X1R5F2-M1
			M8 Connector Models	---	NO	1: +V, 3: 0 V, 4: Control output	I	E2E-X1R5E1-M3	E2E-X1R5F1-M3
					NC	1: +V, 3: 0 V, 2: Control output		E2E-X1R5E2-M3	E2E-X1R5F2-M3
M12	2 mm		Pre-wired Models (2 m)	PVC (oil-resistant)	NO	---	---	E2E-X2E1 2M *1*2*3*4	E2E-X2F1 2M *1*2*3
					NC			E2E-X2E2 2M	E2E-X2F2 2M
			M12 Connector Models	---	NO	1: +V, 3: 0 V, 4: Control output	B	E2E-X2E1-M1	E2E-X2F1-M1
					NC	1: +V, 3: 0 V, 2: Control output	D	E2E-X2E2-M1	E2E-X2F2-M1
M18	5 mm		Pre-wired Models (2 m)	PVC (oil-resistant)	NO	---	---	E2E-X5E1 2M *1*2*3*4	E2E-X5F1 2M *1*2*3
					NC			E2E-X5E2 2M	E2E-X5F2 2M
			M12 Connector Models	---	NO	1: +V, 3: 0 V, 4: Control output	B	E2E-X5E1-M1	E2E-X5F1-M1
					NC	1: +V, 3: 0 V, 2: Control output	D	E2E-X5E2-M1	E2E-X5F2-M1
M30	10 mm		Pre-wired Models (2 m)	PVC (oil-resistant)	NO	---	---	E2E-X10E1 2M *1*2*3*4	E2E-X10F1 2M *2
					NC			E2E-X10E2 2M	E2E-X10F2 2M
			M12 Connector Models	---	NO	1: +V, 3: 0 V, 4: Control output	B	E2E-X10E1-M1	E2E-X10F1-M1
					NC	1: +V, 3: 0 V, 2: Control output	D	E2E-X10E2-M1	E2E-X10F2-M1

\*1. The standard stock includes models with a cable length of 5 m. Specify the cable length at the end of the model number. (Example: E2E-X2E1 5M)

\*2. Models with a flexible cable are also available. Add -R to the end of the model number. (example: E2E-X5E1-R 2M).

\*3. Models with different frequencies are also available. The model number is E2E-X□□□□5 (example: E2E-X5E15 2M).

\*4. Models with pre-wired e-CON connectors are also available (cable length: 0.3 m). Add "-ECON 0.3M" to the end of the model number. (Example: E2E-X2E1-ECON 0.3M)

\*5. Refer to page 24 for details.

## 3-Wire Models

Unshielded DC 3-Wire Models [Refer to *Dimensions* on page 29.]

Appearance	Sensing distance		Connection method	Cable specifications	Operation mode	Pin arrangement	Applicable connector code *5	Model	
								NPN output	PNP output
M8	2 mm		Pre-wired Models (2 m)	PVC (oil-resistant)	NO	---	---	E2E-X2ME1 2M *2	E2E-X2MF1 2M *2
					NC			E2E-X2ME2 2M	E2E-X2MF2 2M
			M12 Connector Models	---	NO	1: +V, 3: 0 V, 4: Control output	B	E2E-X2ME1-M1	E2E-X2MF1-M1
					NC	1: +V, 3: 0 V, 2: Control output	D	E2E-X2ME2-M1	E2E-X2MF2-M1
			M8 Connector Models	---	NO	1: +V, 3: 0 V, 4: Control output	I	E2E-X2ME1-M3	E2E-X2MF1-M3
					NC	1: +V, 3: 0 V, 2: Control output		E2E-X2ME2-M3	E2E-X2MF2-M3
M12	5 mm		Pre-wired Models (2 m)	PVC (oil-resistant)	NO	---	---	E2E-X5ME1 2M *1*2*3*4	E2E-X5MF1 2M *2
					NC			E2E-X5ME2 2M	E2E-X5MF2 2M
			M12 Connector Models	---	NO	1: +V, 3: 0 V, 4: Control output	B	E2E-X5ME1-M1	E2E-X5MF1-M1
					NC	1: +V, 3: 0 V, 2: Control output	D	E2E-X5ME2-M1	E2E-X5MF2-M1
M18	10 mm		Pre-wired Models (2 m)	PVC (oil-resistant)	NO	---	---	E2E-X10ME1 2M *1*2*3*4	E2E-X10MF1 2M *2
					NC			E2E-X10ME2 2M	E2E-X10MF2 2M
			M12 Connector Models	---	NO	1: +V, 3: 0 V, 4: Control output	B	E2E-X10ME1-M1	E2E-X10MF1-M1
					NC	1: +V, 3: 0 V, 2: Control output	D	E2E-X10ME2-M1	E2E-X10MF2-M1
M30	18 mm		Pre-wired Models (2 m)	PVC (oil-resistant)	NO	---	---	E2E-X18ME1 2M *1*2*3*4	E2E-X18MF1 2M *2
					NC			E2E-X18ME2 2M	E2E-X18MF2 2M
			M12 Connector Models	---	NO	1: +V, 3: 0 V, 4: Control output	B	E2E-X18ME1-M1	E2E-X18MF1-M1
					NC	1: +V, 3: 0 V, 2: Control output	D	E2E-X18ME2-M1	E2E-X18MF2-M1

\*1. The standard stock includes models with a cable length of 5 m. Specify the cable length at the end of the model number. (Example: E2E-X5ME1 5M)

\*2. Models with a flexible cable are also available. Add -R to the end of the model number. (example: E2E-X5E1-R 2M).

\*3. Models with different frequencies are also available. The model number is E2E-X□M□□□5 (example: E2E-X5ME15 2M).

\*4. Models with pre-wired e-CON connectors are also available (cable length: 0.3 m). Add "-ECON 0.3M" to the end of the model number. (Example: E2E-X2E1-ECON 0.3M)

\*5. Refer to page 24 for details.

## Ratings and Specifications

### E2E-X□D□ DC 2-Wire Models

Item	Size		M8		M12		M18		M30	
	Shielded	Model	Shielded	Unshielded	Shielded	Unshielded	Shielded	Unshielded	Shielded	Unshielded
			E2E-X2D□	E2E-X4MD□	E2E-X3D□	E2E-X8MD□	E2E-X7D□	E2E-X14MD□	E2E-X10D□	E2E-X20MD□
<b>Sensing distance</b>			2 mm ±10%	4 mm ±10%	3 mm ±10%	8 mm ±10%	7 mm ±10%	14 mm ±10%	10 mm ±10%	20 mm ±10%
<b>Set distance *1</b>			0 to 1.6 mm	0 to 3.2 mm	0 to 2.4 mm	0 to 6.4 mm	0 to 5.6 mm	0 to 11.2 mm	0 to 8 mm	0 to 16 mm
<b>Differential travel</b>			15% max. of sensing distance		10% max. of sensing distance					
<b>Detectable object</b>	Ferrous metal (The sensing distance decreases with non-ferrous metal. Refer to <i>Engineering Data</i> on pages 18 and 19.)									
<b>Standard sensing object</b>			Iron, 8 × 8 × 1 mm	Iron, 20 × 20 × 1 mm	Iron, 12 × 12 × 1 mm	Iron, 30 × 30 × 1 mm	Iron, 18 × 18 × 1 mm	Iron, 30 × 30 × 1 mm		Iron, 54 × 54 × 1 mm
<b>Response frequency *2</b>			1.5 kHz	1 kHz		0.8 kHz	0.5 kHz	0.4 kHz		0.1 kHz
<b>Power supply voltage (operating voltage range)</b>	12 to 24 VDC (10 to 30 VDC), ripple (p-p): 10% max.									
<b>Leakage current</b>	0.8 mA max.									
<b>Control output</b>	<b>Load current</b>	3 to 100 mA, Diagnostic output: 50 mA for -D1(5)S Models								
	<b>Residual voltage *3</b>	3 V max. (Load current: 100 mA, Cable length: 2 m, M1J-T Models only: 5 V max.)								
<b>Indicators</b>	D1 Models: Operation indicator (red) and setting indicator (green) D2 Models: Operation indicator (red)									
<b>Operation mode (with sensing object approaching)</b>	D1 Models: NO      Refer to the timing charts under <i>I/O Circuit Diagrams</i> on page 21 for details. D2 Models: NC									
<b>Diagnostic output delay</b>	0.3 to 1 s									
<b>Protection circuits</b>	Surge suppressor, Load short-circuit protection (for control and diagnostic output)									
<b>Ambient temperature range</b>	Operating: -25 to 70°C, Storage: -40 to 85°C (with no icing or condensation)									
<b>Ambient humidity range</b>	Operating/storage: 35% to 95% (with no condensation)									
<b>Temperature influence</b>	±15% max. of sensing distance at 23°C in the temperature range of -25 to 70°C				±10% max. of sensing distance at 23°C in the temperature range of -25 to 70°C					
<b>Voltage influence</b>	±1% max. of sensing distance at rated voltage in the rated voltage ±15% range									
<b>Insulation resistance</b>	50 MΩ min. (at 500 VDC) between current-carrying parts and case									
<b>Dielectric strength</b>	1000 VAC, 50/60 Hz for 1 minute between current carry parts and case									
<b>Vibration resistance</b>	Destruction: 10 to 55 Hz, 1.5-mm double amplitude for 2 hours each in X, Y, and Z directions									
<b>Shock resistance</b>	Destruction: 500 m/s <sup>2</sup> 10 times each in X, Y, and Z directions				Destruction: 1,000 m/s <sup>2</sup> 10 times each in X, Y, and Z directions					
<b>Degree of protection</b>	Pre-wired Models: IEC 60529 IP67, in-house standards: oil-resistant Connector Models: IEC 60529 IP67									
<b>Connection method</b>	Pre-wired Models (Standard cable length: 2 m), Connector Models, or Pre-wired Connector Models (Standard cable length: 0.3 m)									
<b>Weight (packed state)</b>	<b>Pre-wired Models</b>	Approx. 60 g			Approx. 70 g		Approx. 130 g		Approx. 175 g	
	<b>Pre-wired Connector Models</b>	---			Approx. 40 g		Approx. 70 g		Approx. 110 g	
	<b>Connector Models</b>	Approx. 15 g			Approx. 25 g		Approx. 40 g		Approx. 90 g	
<b>Materials</b>	<b>Case</b>	Stainless steel (SUS303)			Nickel-plated brass					
	<b>Sensing surface</b>	PBT								
	<b>Clamping nuts</b>	Nickel-plated brass								
	<b>Toothed washer</b>	Zinc-plated iron								
<b>Accessories</b>	Instruction manual									

\*1. Use the E2E within the range in which the setting indicator (green LED) is ON (except D2 Models).

\*2. The response frequency is an average value.

Measurement conditions are as follows: standard sensing object, a distance of twice the standard sensing object, and a set distance of half the sensing distance.

\*3. The residual voltage of each M1J-T Model is 5 V. When connecting to a device, make sure that the device can withstand the residual voltage. (Refer to page 28 for details.)

## E2E-X□Y□ AC 2-Wire Models

Item	Size	M8		M12		M18		M30	
	Shielded Model	Shielded	Unshielded	Shielded	Unshielded	Shielded	Unshielded	Shielded	Unshielded
		E2E-X1R5Y□	E2E-X2MY□	E2E-X2Y□	E2E-X5MY□	E2E-X5Y□	E2E-X10MY□	E2E-X10Y□	E2E-X18MY□
<b>Sensing distance</b>		1.5 mm ±10%	2 mm ±10%		5 mm ±10%		10 mm ±10%		18 mm ±10%
<b>Set distance</b>		0 to 1.2 mm	0 to 1.6 mm		0 to 4 mm		0 to 8 mm		0 to 14 mm
<b>Differential travel</b>		10% max. of sensing distance							
<b>Detectable object</b>		Ferrous metal (The sensing distance decreases with non-ferrous metal. Refer to <i>Engineering Data</i> on page 19.)							
<b>Standard sensing object</b>		Iron, 8 × 8 × 1 mm	Iron, 12 × 12 × 1 mm		Iron, 15 × 15 × 1 mm	Iron, 18 × 18 × 1 mm	Iron, 30 × 30 × 1 mm		Iron, 54 × 54 × 1 mm
<b>Response frequency</b>		25 Hz							
<b>Power supply voltage (operating voltage range)<sup>1</sup></b>		24 to 240 VAC (20 to 264 VAC), 50/60 Hz							
<b>Leakage current</b>		1.7 mA max.							
<b>Control output</b>	<b>Load current<sup>2</sup></b>	5 to 100 mA		5 to 200 mA		5 to 300 mA			
	<b>Residual voltage</b>	Refer to <i>Engineering Data</i> on page 20.							
<b>Indicators</b>		Operation indicator (red)							
<b>Operation mode (with sensing object approaching)</b>		Y1 Models: NO    Y2 Models: NC    Refer to the timing charts under <i>I/O Circuit Diagrams</i> on page 23 for details.							
<b>Protection circuits</b>		Surge suppressor							
<b>Ambient temperature range<sup>*1,2</sup></b>		Operating/Storage: -25 to 70°C (with no icing or condensation)			Operating/Storage: -40 to 85°C (with no icing or condensation)				
<b>Ambient humidity range</b>		Operating/storage: 35% to 95% (with no condensation)							
<b>Temperature influence</b>		±10% max. of sensing distance at 23°C in the temperature range of -25 to 70°C			±15% max. of sensing distance at 23°C in the temperature range of -40 to 85°C, ±10% max. of sensing distance at 23°C in the temperature range of -25 to 70°C				
<b>Voltage influence</b>		±1% max. of sensing distance at rated voltage in the rated voltage ±15% range							
<b>Insulation resistance</b>		50 MΩ min. (at 500 VDC) between current-carrying parts and case							
<b>Dielectric strength</b>		4,000 VAC (M8 Models: 2,000 VAC), 50/60 Hz for 1 min between current-carrying parts and case							
<b>Vibration resistance</b>		Destruction: 10 to 55 Hz, 1.5-mm double amplitude for 2 hours each in X, Y, and Z directions							
<b>Shock resistance</b>		Destruction: 500 m/s <sup>2</sup> 10 times each in X, Y, and Z directions			Destruction: 1,000 m/s <sup>2</sup> 10 times each in X, Y, and Z directions				
<b>Degree of protection</b>		Pre-wired Models: IEC 60529 IP67, in-house standards: oil-resistant Connector Models: IEC 60529 IP67							
<b>Connection method</b>		Pre-wired Models (Standard cable length: 2 m) and Connector Models							
<b>Weight</b>	<b>Pre-wired Models Model</b>	Approx. 60 g		Approx. 70 g		Approx. 130 g		Approx. 175 g	
	<b>Connector Models</b>	Approx. 15 g		Approx. 25 g		Approx. 40 g		Approx. 90 g	
<b>Materials</b>	<b>Case</b>	Stainless steel (SUS303)		Nickel-plated brass					
	<b>Sensing surface</b>	PBT							
	<b>Clamping nuts</b>	Nickel-plated brass							
	<b>Toothed washer</b>	Zinc-plated iron							
<b>Accessories</b>		Instruction manual							

\*1. When supplying 24 VAC to any of the above models, make sure that the operating ambient temperature range is at least -25°C.

\*2. When using an M18 or M30 Connector Model at an ambient temperature between 70 and 85°C, make sure that the Sensor has a control output (load current) of 5 to 200 mA max.

## E2E-X□T1 AC/DC 2-Wire Models

Item	Size Shielded Model	M12	M18	M30
		Shielded		
		E2E-X3T1	E2E-X7T1	E2E-X10T1
Sensing distance		3 mm ±10%	7 mm ±10%	10 mm ±10%
Set distance		0 to 2.4 mm	0 to 5.6 mm	0 to 8 mm
Differential travel		10% max. of sensing distance		
Detectable object		Ferrous metal (The sensing distance decreases with non-ferrous metal. Refer to <i>Engineering Data</i> on page 18.)		
Standard sensing object		Iron, 12 × 12 × 1 mm	Iron, 18 × 18 × 1 mm	Iron, 30 × 30 × 1 mm
Response frequency *1	DC	1 kHz	0.5 kHz	0.4 kHz
	AC	25 Hz		
Power supply voltage (operating voltage range) *2		24 to 240 VDC (20 to 264 VDC) 48 to 240 VAC (40 to 264 VAC)		
Leakage current		DC: 1 mA max. AC: 2 mA max.		
Control output	Load current	5 to 100 mA		
	Residual voltage	DC: 6 V max. (Load current: 100 mA, Cable length: 2 m) AC: 10 V max. (Load current: 5 mA, Cable length: 2 m)		
Indicators		Operation indicator (red), Setting indicator (green)		
Operation mode (with sensing object approaching)		NO (Refer to the timing charts under <i>I/O Circuit Diagrams</i> on page 21 for details.)		
Protection circuits		Load short-circuit protection (20 to 40 VDC only), Surge suppressor		
Ambient temperature range		Operating: -25 to 70°C, Storage: -40 to 85°C (with no icing or condensation)		
Ambient humidity range		Operating/Storage: 35% to 95% (with no condensation)		
Temperature influence		±10% max. of sensing distance at 23°C in the temperature range of -25 to 70°C		
Voltage influence		±1% max. of sensing distance at rated voltage in the rated voltage ±15% range		
Insulation resistance		50 MΩ min. (at 500 VDC) between current-carrying parts and case		
Dielectric strength		4,000 VAC, 50/60 Hz for 1 minute between current-carrying parts and case		
Vibration resistance		Destruction: 10 to 55 Hz, 1.5-mm double amplitude for 2 hours each in X, Y, and Z directions		
Shock resistance		Destruction: 1,000 m/s <sup>2</sup> 10 times each in X, Y, and Z directions		
Degree of protection		IEC 60529 IP67, in-house standards: oil-resistant		
Connection method		Pre-wired Models (Standard cable length: 2 m)		
Weight (packed state)		Approx. 80 g	Approx. 140 g	Approx. 190 g
Materials	Case	Nickel-plated brass		
	Sensing surface	PBT		
	Clamping nuts	Nickel-plated brass		
	Toothed washer	Zinc-plated iron		
Accessories		Instruction manual		

\*1. The response frequency is an average value. Measurement conditions are as follows: standard sensing object, a distance of twice the standard sensing object, and a set distance of half the sensing distance.

\*2. Power Supply Voltage Waveform:

Use a sine wave for the power supply. Using a rectangular AC power supply may result in faulty reset.

## E2E-X□E□/F□ DC 3-Wire Models

Item	Size Shielded Model	M8		M12		M18		M30	
		Shielded	Unshielded	Shielded	Unshielded	Shielded	Unshielded	Shielded	Unshielded
		E2E -X1R5E□/F□	E2E -X2ME□/F□	E2E -X2E□/F□	E2E -X5ME□/F□	E2E -X5E□/F□	E2E -X10ME□/F□	E2E-X10E□/ F□	E2E -X18ME□/F□
<b>Sensing distance</b>		1.5 mm ±10%	2 mm ±10%		5 mm ±10%		10 mm ±10%		18 mm ±10%
<b>Set distance</b>		0 to 1.2 mm	0 to 1.6 mm		0 to 4 mm		0 to 8 mm		0 to 14 mm
<b>Differential travel</b>		10% max. of sensing distance							
<b>Detectable object</b>		Ferrous metal (The sensing distance decreases with non-ferrous metal. Refer to <i>Engineering Data</i> on pages 18 and 19.)							
<b>Standard sensing object</b>		Iron, 8 × 8 × 1 mm	Iron, 12 × 12 × 1 mm		Iron, 15 × 15 × 1 mm	Iron, 18 × 18 × 1 mm	Iron, 30 × 30 × 1 mm		Iron, 54 × 54 × 1 mm
<b>Response frequency</b> *1		2 kHz	0.8 kHz	1.5 kHz	0.4 kHz	0.6 kHz	0.2 kHz	0.4 kHz	0.1 kHz
<b>Power supply voltage (operating voltage range)</b> *2		12 to 24 VDC (10 to 40 VDC), ripple (p-p): 10% max.							
<b>Current consumption</b>		13 mA max.							
<b>Control output</b>	<b>Load current</b> *2	200 mA max.							
	<b>Residual voltage</b>	2 V max. (Load current: 200 mA, Cable length: 2 m)							
<b>Indicators</b>		Operation indicator (red)							
<b>Operation mode (with sensing object approaching)</b>		E1/F1 Models: NO E2/F2 Models: NC Refer to the timing charts under <i>I/O Circuit Diagrams</i> on page 21 for details.							
<b>Protection circuits</b>		Load short-circuit protection, Surge suppressor, Reverse polarity protection							
<b>Ambient temperature range</b> *2		Operating/Storage: -40 to 85°C (with no icing or condensation)							
<b>Ambient humidity range</b>		Operating/Storage: 35% to 95% (with no condensation)							
<b>Temperature influence</b>		±15% max. of sensing distance at 23°C in the temperature range of -40 to 85°C ±10% max. of sensing distance at 23°C in the temperature range of -25 to 70°C							
<b>Voltage influence</b>		±1% max. of sensing distance at rated voltage in the rated voltage ±15% range							
<b>Insulation resistance</b>		50 MΩ min. (at 500 VDC) between current-carrying parts and case							
<b>Dielectric strength</b>		1,000 VAC, 50/60 Hz for 1 minute between current carry parts and case							
<b>Vibration resistance</b>		Destruction: 10 to 55 Hz, 1.5-mm double amplitude for 2 hours each in X, Y, and Z directions							
<b>Shock resistance</b>		Destruction: 500 m/s <sup>2</sup> 10 times each in X, Y, and Z directions			Destruction: 1,000 m/s <sup>2</sup> 10 times each in X, Y, and Z directions				
<b>Degree of protection</b>		Pre-wired Models : IEC 60529 IP67, in-house standards: oil-resistant Connector Models : IEC 60529 IP67							
<b>Connection method</b>		Pre-wired Models (Standard cable length: 2 m) and Connector Models							
<b>Weight</b>	<b>Pre-wired Models</b>	Approx. 65 g		Approx. 75 g		Approx. 150 g		Approx. 195 g	
	<b>Connector Models</b>	Approx. 15 g		Approx. 25 g		Approx. 40 g		Approx. 90 g	
<b>Materials</b>	<b>Case</b>	Stainless steel (SUS303)		Nickel-plated brass					
	<b>Sensing surface</b>	PBT							
	<b>Clamping nuts</b>	Nickel-plated brass							
	<b>Toothed washer</b>	Zinc-plated iron							
<b>Accessories</b>		Instruction manual							

\*1. The response frequency is an average value. Measurement conditions are as follows: standard sensing object, a distance of twice the standard sensing object, and a set distance of half the sensing distance.

\*2. When using an M8 Model at an ambient temperature between 70 and 85°C, supply 10 to 30 VDC to the Sensor and make sure that the Sensor has a control output of 100 mA maximum.



## E2E-C□C/B□ and E2E-X1C/B□ DC 3-Wire Models

Item	Size	3 dia.	4 dia.	M5	5.4 dia.
	Shielded Model	Shielded			
		E2E-CR6C/B□	E2E-CR8C/B□	E2E-X1C/B□	E2E-C1C/B□
<b>Sensing distance</b>		0.6 mm ±15%	0.8 mm ±15%	1 mm ±15%	
<b>Set distance</b>		0 to 0.4 mm	0 to 0.5 mm	0 to 0.7 mm	
<b>Differential travel</b>		15% max. of sensing distance			
<b>Detectable object</b>		Ferrous metal (The sensing distance decreases with non-ferrous metal. Refer to <i>Engineering Data</i> on pages 18 and 19.)			
<b>Standard sensing object</b>		Iron, 3 × 3 × 1 mm	Iron, 5 × 5 × 1 mm		
<b>Response frequency *</b>		2 kHz	3 kHz		
<b>Power supply voltage (operating voltage range)</b>		12 to 24 VDC (10 to 30 VDC), ripple (p-p): 10% max.			
<b>Current consumption</b>		10 mA max.	17 mA max.		
<b>Control output</b>	<b>Load current</b>	Open-collector output, 80 mA max. (30 VDC max.)	Open-collector output, 100 mA max. (30 VDC max.)		
	<b>Residual voltage</b>	1 V max. (Load current: 80 mA, Cable length: 2 m)	2 V max. (Load current: 100 mA, Cable length: 2 m)		
<b>Indicators</b>		Operation indicator (red)			
<b>Operation mode (with sensing object approaching)</b>		C1/B1 Models: NO C2 Models: NC	Refer to the timing charts under <i>I/O Circuit Diagrams</i> on page 22 for details.		
<b>Protection circuits</b>		Reverse polarity protection, Surge suppressor			
<b>Ambient temperature range</b>		Operating/Storage: -25 to 70°C (with no icing or condensation)			
<b>Ambient humidity range</b>		Operating/Storage: 35% to 95% (with no condensation)			
<b>Temperature influence</b>		±15% max. of sensing distance at 23°C in the temperature range of -25 to 70°C			
<b>Voltage influence</b>		±5% max. of sensing distance at rated voltage in the rated voltage ±10% range	±2.5% max. of sensing distance at rated voltage in the rated voltage ±15% range		
<b>Insulation resistance</b>		50 MΩ min. (at 500 VDC) between current-carrying parts and case			
<b>Dielectric strength</b>		500 VAC, 50/60 Hz for 1 min between current-carrying parts and case			
<b>Vibration resistance</b>		Destruction: 10 to 55 Hz, 1.5-mm double amplitude for 2 hours each in X, Y, and Z directions			
<b>Shock resistance</b>		Destruction: 500 m/s <sup>2</sup> 10 times each in X, Y, and Z directions			
<b>Degree of protection</b>		IEC 60529 IP66	IEC 60529 IP67, in-house standards: oil-resistant		
<b>Connection method</b>		Pre-wired Models (Standard cable length: 2 m)			
<b>Weight (packed state)</b>		Approx. 60 g			
<b>Materials</b>	<b>Case</b>	Stainless steel (SUS303)	Nickel-plated brass		
	<b>Sensing surface</b>	Heat-resistant ABS			
	<b>Clamping nuts</b>	Nickel-plated brass (E2E-X1C/B□ only)			
	<b>Toothed washer</b>	Zinc-plated iron (E2E-X1C/B□ only)			
<b>Accessories</b>		Instruction manual			

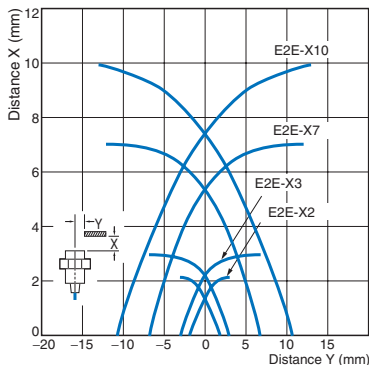
\* The response frequency is an average value. Measurement conditions are as follows: standard sensing object, a distance of twice the standard sensing object, and a set distance of half the sensing distance.

# Engineering Data (Typical)

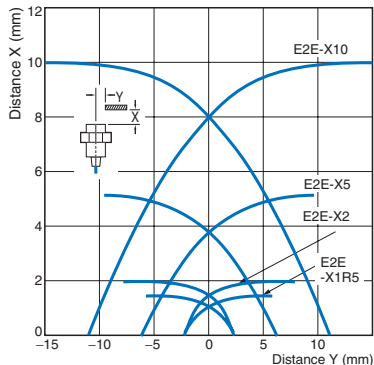
## Sensing Area

### Shielded Models

#### E2E-X□D□/-X□T1

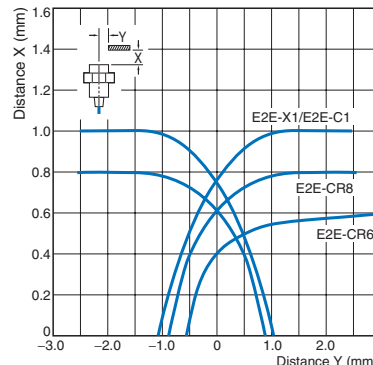


#### E2E-X□E□/-X□Y□/-X□F□



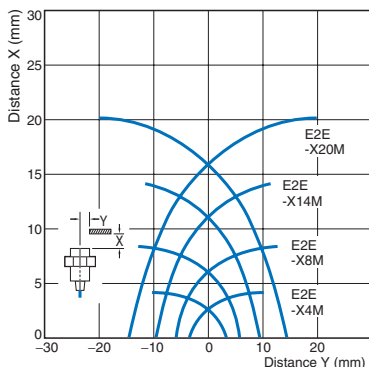
#### E2E-C□C□/-X□C□

#### E2E-C□B1/-X□B□

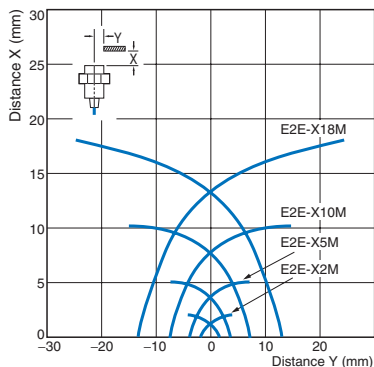


### Unshielded Models

#### E2E-X□MD□

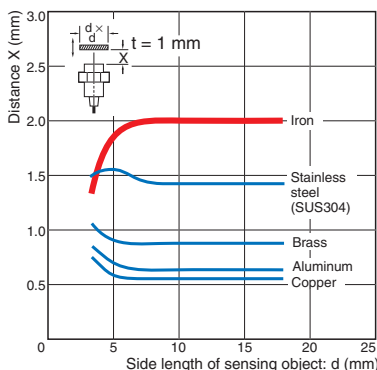


#### E2E-X□ME□/-X□MY□/-X□MF□

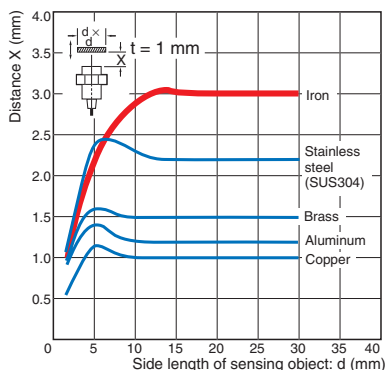


## Influence of Sensing Object Size and Material

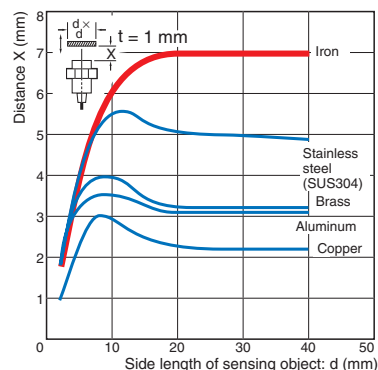
### E2E-X2D□



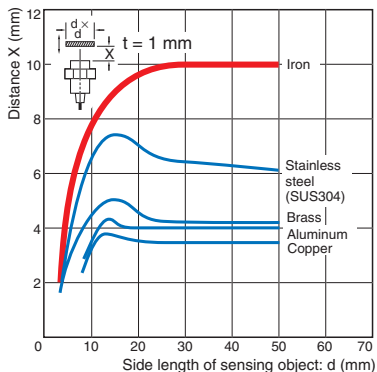
### E2E-X3D□/-X3T1



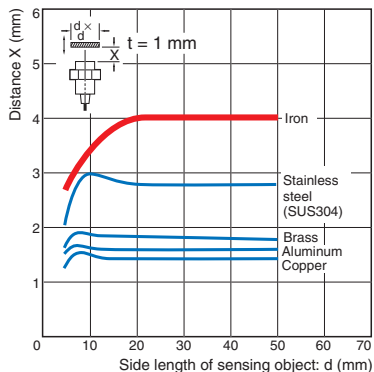
### E2E-X7D□/-X7T1



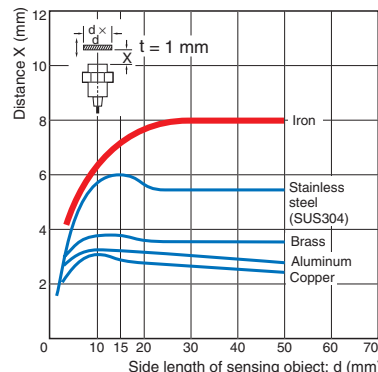
### E2E-X10D□/-X10T1



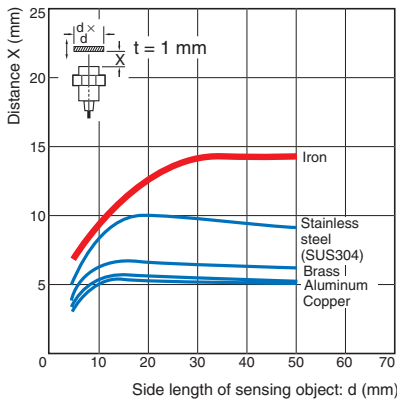
### E2E-X4MD□



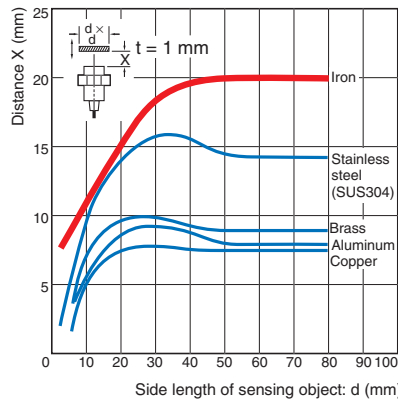
### E2E-X8MD□



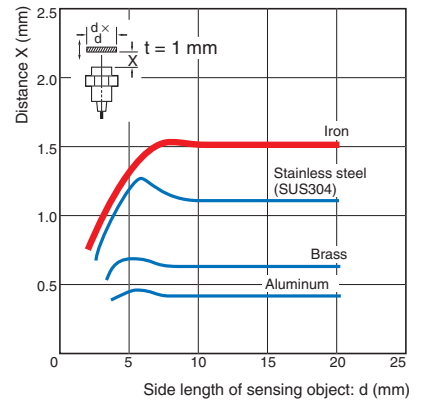
**E2E-X14MD**



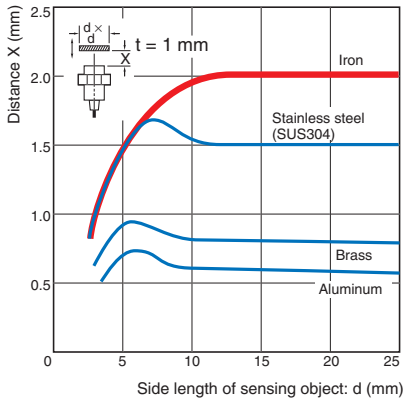
**E2E-X20MD**



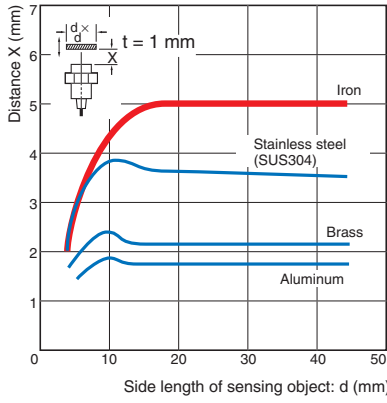
**E2E-X1R5E/-X1R5Y/-X1R5F**



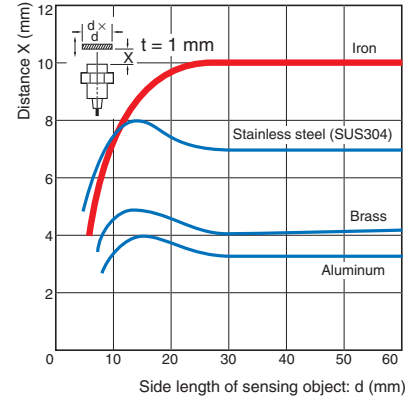
**E2E-X2E/-X2Y/-X2F**



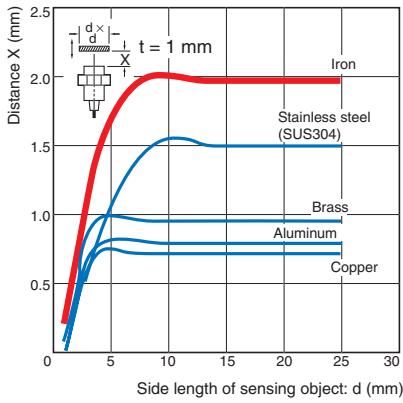
**E2E-X5E/-X5Y/-X5F**



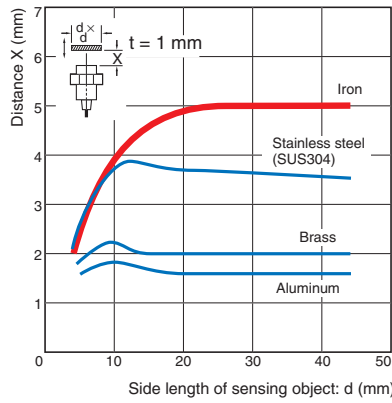
**E2E-X10E/-X10Y/-X10F**



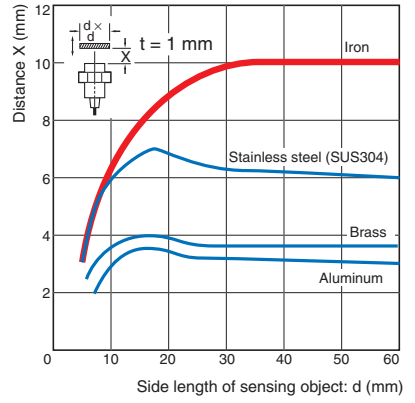
**E2E-X2ME/-X2MY/-X2MF**



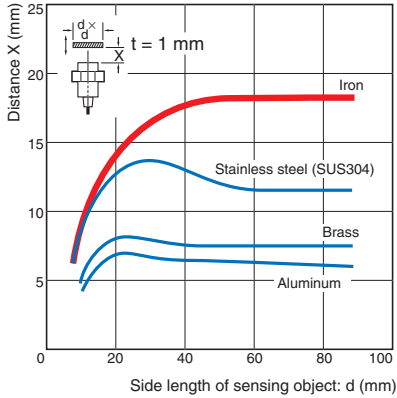
**E2E-X5ME/-X5MY/-X5MF**



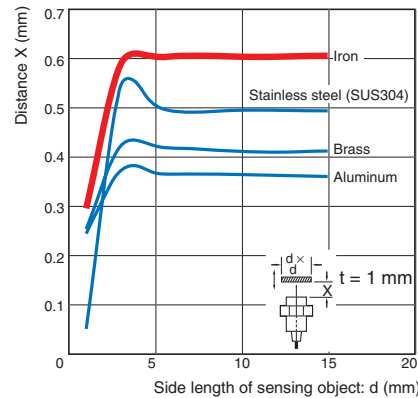
**E2E-X10ME/-X10MY/-X10MF**



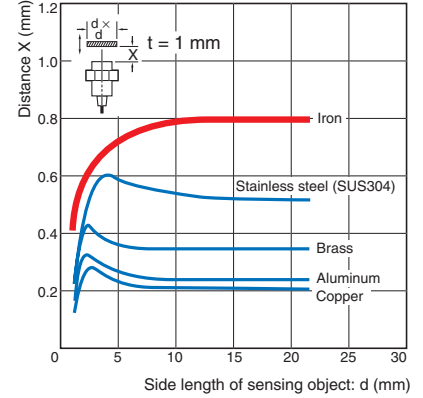
**E2E-X18ME/-X18MY/-X18MF**



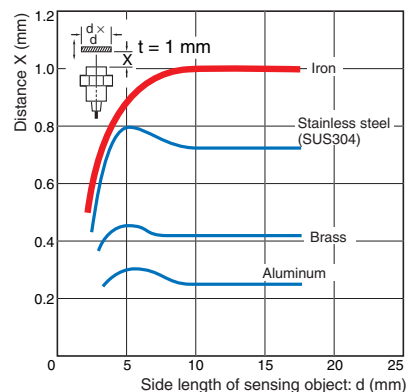
**E2E-CR6**



**E2E-CR8**

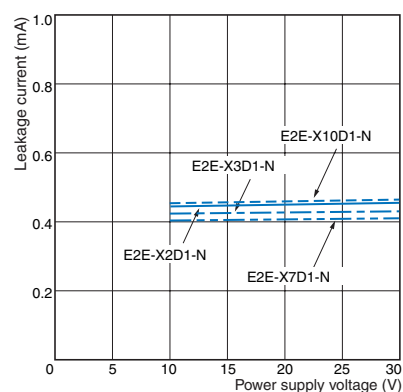


## E2E-X1□/C1□

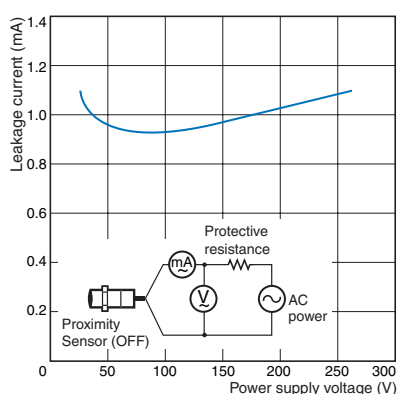


## Leakage Current

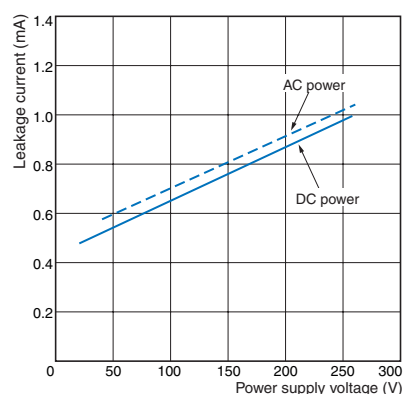
### E2E-X□D□



### E2E-X□Y□

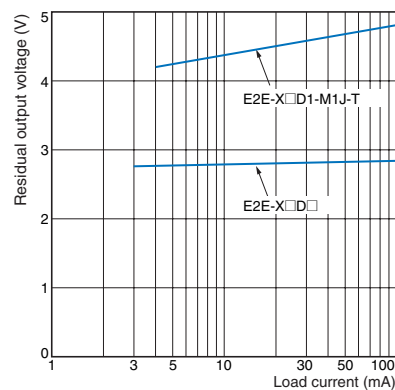


### E2E-X□T1

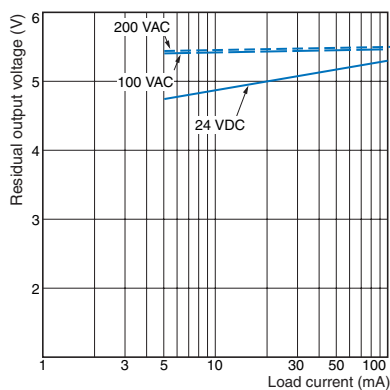


## Residual Output Voltage

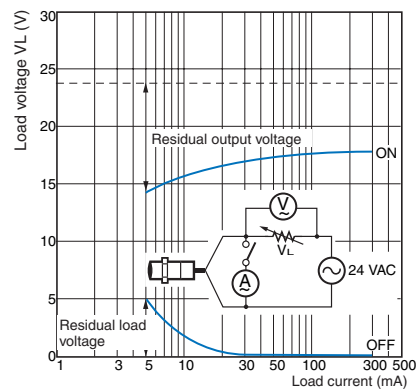
### E2E-X□D□



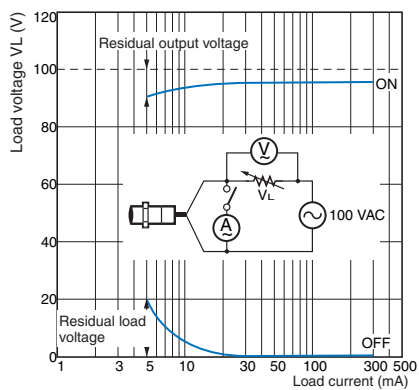
### E2E-X□T1



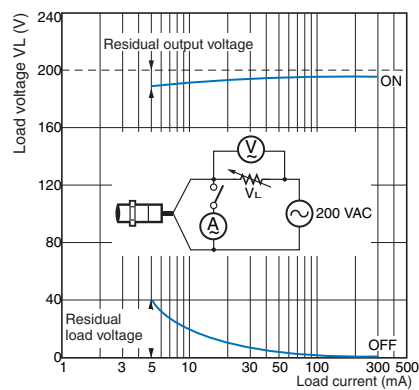
### E2E-X□Y□ at 24 VAC



### E2E-X□Y□ at 100 VAC



### E2E-X□Y□ at 200 VAC



# I/O Circuit Diagrams

## E2E-X□D□ DC 2-Wire Models

Operation mode	Model	Timing Chart	Output circuit
<p><b>Without self-diagnostic output: NO</b></p>	<p>E2E-X□D1-N E2E-X□D1-M1G(J) E2E-X□D1-(M1TGJ)-U E2E-X□D1-M3G</p>		<p>Polarity: Yes</p> <p>Note: The load can be connected to either the +V or 0 V side.</p>
	<p>E2E-X□D1-M1J-T</p>		<p>Polarity: None</p> <p>Note 1. The load can be connected to either the +V or 0 V side. 2. The E2E-X□D1-M1J-T has no polarity. Therefore, terminals 3 and 4 have no polarity.</p>
<p><b>Without self-diagnostic output: NC</b></p>	<p>E2E-X□D2-N E2E-X□D2-M1G E2E-X□D2-(M1TGJ)-U E2E-X□D2-M3G</p>		<p>Note: The load can be connected to either the +V or 0 V side.</p>
<p><b>With self-diagnostic output: NO</b></p>	<p>E2E-X□D1S E2E-X□D1S-M1</p>	<p>* The diagnostic output is ON when there is a coil burnout or the sensing object is located in the unstable sensing area for 0.3 s or longer.</p>	<p>Note: Connect both the loads to the +V side of the control output and diagnostic output.</p>

DC 3-Wire Models

Operation mode	Output specifications	Model	Timing Chart	Output circuit
NO	NPN output	E2E-X□E□ E2E-X□E□-M1 E2E-X□E□-M3	Sensing object Present Not present Operation indicator (red) ON OFF Control output (between brown and black leads) ON OFF Output voltage (between black and blue leads) High Low	<p>*Constant current output is 1.5 to 3 mA.                      Note: For Connector Models, the connection between pins 1, 4 and 3 uses an NO contact, and the connection between pins 1, 2 and 3 uses an NC contact.</p>
			Sensing object Present Not present Operation indicator (red) ON OFF Control output (between brown and black leads) ON OFF Output voltage (between black and blue leads) High Low	
NC	NPN output	E2E-X□E□ E2E-X□E□-M1 E2E-X□E□-M3	Sensing object Present Not present Operation indicator (red) ON OFF Control output (between brown and black leads) ON OFF Output voltage (between black and blue leads) High Low	<p>*Constant current output is 1.5 to 3 mA.                      Note: For Connector Models, the connection between pins 1, 4 and 3 uses an NO contact, and the connection between pins 1, 2 and 3 uses an NC contact.</p>
			Sensing object Present Not present Operation indicator (red) ON OFF Control output (between brown and black leads) ON OFF Output voltage (between black and blue leads) High Low	
NO	PNP output	E2E-X□F□ E2E-X□F□-M1 E2E-X□F□-M3	Sensing object Present Not present Operation indicator (red) ON OFF Control output (Between blue and black leads) ON OFF Output voltage (between brown and black leads) High Low	<p>*When a transistor is connected                      Note: For Connector Models, the connection between pins 1, 4 and 3 uses an NO contact, and the connection between pins 1, 2 and 3 uses an NC contact.</p>
			Sensing object Present Not present Operation indicator (red) ON OFF Control output (Between blue and black leads) ON OFF Output voltage (between brown and black leads) High Low	
NC	PNP output	E2E-X□F□ E2E-X□F□-M1 E2E-X□F□-M3	Sensing object Present Not present Operation indicator (red) ON OFF Control output (Between blue and black leads) ON OFF Output voltage (between brown and black leads) High Low	<p>*When a transistor is connected                      Note: For Connector Models, the connection between pins 1, 4 and 3 uses an NO contact, and the connection between pins 1, 2 and 3 uses an NC contact.</p>
			Sensing object Present Not present Operation indicator (red) ON OFF Control output (Between blue and black leads) ON OFF Output voltage (between brown and black leads) High Low	
NO	NPN open-collector output	E2E-C/X□C□	Sensing object Present Not present Operation indicator (red) ON OFF Control output ON OFF	<p>*The E2E-CR6□ does not have 100-Ω resistance.</p>
			Sensing object Present Not present Operation indicator (red) ON OFF Control output ON OFF	
NC	NPN open-collector output	E2E-C/X□C□	Sensing object Present Not present Operation indicator (red) ON OFF Control output ON OFF	<p>*The E2E-CR6□ does not have 100-Ω resistance.</p>
			Sensing object Present Not present Operation indicator (red) ON OFF Control output ON OFF	
NO	PNP open-collector output	E2E-C/X□B□	Sensing object Present Not present Operation indicator (red) ON OFF Control output ON OFF	<p>*The E2E-CR6□ does not have 100-Ω resistance.</p>
			Sensing object Present Not present Operation indicator (red) ON OFF Control output ON OFF	
NC	PNP open-collector output	E2E-C/X□B□	Sensing object Present Not present Operation indicator (red) ON OFF Control output ON OFF	<p>*The E2E-CR6□ does not have 100-Ω resistance.</p>
			Sensing object Present Not present Operation indicator (red) ON OFF Control output ON OFF	

AC 2-Wire Models

Operation mode	Model	Timing Chart	Output circuit
NO	E2E-X□Y□ E2E-X□Y□-M1	<p>Sensing object: Present (ON), Not present (OFF)</p> <p>Operation indicator (red): ON, OFF</p> <p>Control output: Operate, Reset</p>	<p>Note: For Connector Models, the connection between pins 3 and 4 uses an NO contact, and the connection between pins 1 and 2 uses an NC contact.</p>
NC		<p>Sensing object: Present (ON), Not present (OFF)</p> <p>Operation indicator (red): ON, OFF</p> <p>Control output: Operate, Reset</p>	

AC/DC 2-Wire Models

Operation mode	Model	Timing Chart	Output circuit
NO	E2E-X□T1	<p>Sensing object: Non-sensing area, Unstable sensing area, Set position, Stable sensing area</p> <p>Rated sensing distance (%)</p> <p>ON Setting indicator (green), OFF (red)</p> <p>ON Operation indicator (red), OFF (green)</p> <p>ON Control output, OFF (green)</p>	<p>Note: The load can be connected to either the +V or 0 V side. There is no need to be concerned about the polarity (brown/blue) of the Proximity Sensor.</p>

e-CON Connectors

Requirement for e-CON Pre-wired Connector: A Connector is not provided with the Sensor. Be sure to order a Connector separately. [Dimensions: Inquire.]

Appearance	Cable length	Connector model number	Applicable Proximity Sensor model number
<p>Single-end connector</p>	2 m	E39-ECON2M	E2E-X□E□-ECON
	5 m	E39-ECON5M	
<p>Double-end connectors</p>	0.5 to 1 m	E39-ECONW□M	
	1.1 to 1.5 m	□ indicates cable length (in units of m). Specify with 0.1-increments.	
	1.6 to 2 m		

## Sensor I/O Connectors

Model for Connectors and Pre-wired Connectors: A Connector is not provided with the Sensor. Be sure to order a Connector separately.

[Refer to Dimensions for the XS2, XS3, and XS5.]

Applicable connector code	Connector				Applicable Proximity Sensor model number	Connection diagram No. *2
	Screw	Appearance *1	Cable length 2m	Cable length 5m		
			CablConnector model number	CablConnector model number		
A	M12	Straight	XS2F-D421-DA0-A	XS2F-D421-GA0-A	E2E-X□D1-M1G(J)	1
		L-shape	XS2F-D422-DA0-A	XS2F-D422-GA0-A		
B	M12	Straight	XS2F-D421-DC0-A	XS2F-D421-GC0-A	E2E-X□E1-M1 E2E-X□F1-M1	10
		L-shape	XS2F-D422-DC0-A	XS2F-D422-GC0-A		
C	M12	Straight	XS2F-D421-DD0	XS2F-D421-GD0	E2E-X□D1-M1J-T E2E-X□D1-M1	3
		L-shape	XS2F-D422-DD0	XS2F-D422-GD0		E2E-X□D1-M1J-T E2E-X□D1-M1
D	M12	Straight	XS2F-D421-D80-A	XS2F-D421-G80-A	E2E-X□D2-M1G(J)	6
					E2E-X□D2-M1J-T	8
					E2E-X□D2-M1	7
					E2E-X□D1S-M1	5
	M12	L-shape	XS2F-D422-D80-A	XS2F-D422-G80-A	E2E-X□D2-M1G(J)	6
					E2E-X□D2-M1J-T	8
					E2E-X□D2-M1	7
					E2E-X□D1S-M1	5
E	M12	Straight	XS2F-A421-DB0-A	XS2F-A421-GB0-A	E2E-X□Y1-M1	14
		L-shape	XS2F-A422-DB0-A	XS2F-A422-GB0-A		
F	M12	Straight	XS2F-A421-D90-A	XS2F-A421-G90-A	E2E-X□Y2-M1	15
G	M12	Smartclick Connector, Straight	XS5F-D421-D80-A	XS5F-D421-G80-A	E2E-X□D1-M1TGJ	16
H	M12	Smartclick Connector, Straight Oil-resistant Reinforced Cables	XS5F-D421-D80-P	XS5F-D421-G80-P	E2E-X□D1-M1TGJ-U	17
					E2E-X□D2-M1TGJ-U	18
I	M8	Straight	XS3F-M421-402-A	XS3F-M421-405-A	E2E-X□D1-M3G	4
					E2E-X□D2-M3G	9
					E2E-X□E1-M3 E2E-X□F1-M3	12
					E2E-X□E2-M3 E2E-X□F2-M3	13
	M8	L-shape	XS3F-M422-402-A	XS3F-M422-405-A	E2E-X□D1-M3G	4
					E2E-X□D2-M3G	9
					E2E-X□E1-M3 E2E-X□F1-M3	12
					E2E-X□E2-M3 E2E-X□F2-M3	13

Note: Refer to *Introduction to Sensor I/O Connectors* for details and for information on Cable length and Robotics Cables.

\*1. Images of straight and L-shaped connectors.

M12 Straight



M12 L-shape



M8 Straight



M8 L-shape



\*2. Refer to *Connection Diagrams* on page 25 for information on Proximity Sensor and I/O Connector connections.



## Connections for Sensor I/O Connectors

Connection diagram No.	Proximity Sensor			Sensor I/O Connector model number	Connections
	Type	Operation mode	Model		
1	DC 2-wire (IEC pin wiring)	NO	E2E-X□D1-M1G(J)	XS2F-D42□□A0-A 1: Straight 2: L-shape D: 2-m cable G: 5-m cable	
2	DC 2-wire (previous pin wiring)		E2E-X□D1-M1	XS2F-D42□□D0 1: Straight 2: L-shape D: 2-m cable G: 5-m cable	
3	DC 2-wire (no polarity)		E2E-X□D1-M1J-T	XS2F-D42□□D0 1: Straight 2: L-shape D: 2-m cable G: 5-m cable	
4	DC 2-wire (M8 connector)		E2E-X□D1-M3G	XS3F-M42□□40□-A 1: Straight 2: L-shape 2: 2-m cable 5: 5-m cable	
5	DC 2-wire (diagnostic type)		E2E-X□D1S-M1	XS2F-D42□□80-A 1: Straight 2: L-shape D: 2-m cable G: 5-m cable	
6	DC 2-wire (IEC pin wiring)	NC	E2E-X□D2-M1G(J)	XS2F-D42□□80-A 1: Straight 2: L-shape D: 2-m cable G: 5-m cable	
7	DC 2-wire (previous pin wiring)		E2E-X□D2-M1	XS2F-D42□□80-A 1: Straight 2: L-shape D: 2-m cable G: 5-m cable	
8	DC 2-wire (no polarity)		E2E-X□D2-M1J-T	XS2F-D42□□80-A 1: Straight 2: L-shape D: 2-m cable G: 5-m cable	
9	DC 2-wire (M8 connector)		E2E-X□D2-M3G	XS3F-M42□□40□-A 1: Straight 2: L-shape 2: 2-m cable 5: 5-m cable	

\* Different from Proximity Sensor wire colors.

Connection diagram No.	Proximity Sensor			Sensor I/O Connector model number	Connections
	Type	Operation mode	Model		
10	DC 3-wire	NO	E2E-X□E/F1-M1	XS2F-D42□-□C0-A 1: Straight 2: L-shape D: 2-m cable G: 5-m cable	
11		NC	E2E-X□E2/F2-M1	XS2F-D42□-□80-A 1: Straight 2: L-shape D: 2-m cable G: 5-m cable	
12	DC 3-wire (M8 connector)	NO	E2E-X□E1/F1-M3	XS3F-M42□-□40□-A 1: Straight 2: L-shape 2: 2-m cable 5: 5-m cable	
13		NC	E2E-X□E2/F2-M3	XS3F-M42□-□40□-A 1: Straight 2: L-shape 2: 2-m cable 5: 5-m cable	
14	AC 2-wire	NO	E2E-X□Y1-M1	XS2F-A42□-□B0-A 1: Straight 2: L-shape D: 2-m cable G: 5-m cable	
15		NC	E2E-X□Y2-M1	XS2F-A421□-□90-A D: 2-m cable G: 5-m cable	
16	DC 2-wire (Smartclick connector)	NO	E2E-X□D1-M1TGJ	XS5F-D421□-□80-A D: 2-m cable G: 5-m cable	
17			E2E-X□D1-M1TGJ-U	XS5F-D421□-□80-P D: 2-m cable G: 5-m cable	
18			NC	E2E-X□D2-M1TGJ-U	XS5F-D421□-□80-P D: 2-m cable G: 5-m cable

\* Different from Proximity Sensor wire colors.

**Refer to Introduction to Sensor I/O Connectors for details.**

## Safety Precautions

Refer to *Warranty and Limitations of Liability*.

### ⚠ WARNING

This product is not designed or rated for ensuring safety of persons either directly or indirectly. Do not use it for such purposes.



### ⚠ CAUTION

- Do not short the load. Explosion or burning may result.
- Do not supply power to the Sensor with no load, otherwise Sensor may be damaged.



Applicable Models

E2E-CR6□  
E2E-CR8□  
E2E-X1□  
E2E-C1□

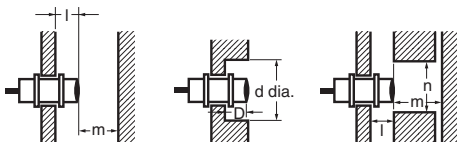
### Precautions for Correct Use

Do not use this product under ambient conditions that exceed the ratings.

#### ● Design

#### Influence of Surrounding Metal

When mounting the Sensor within a metal panel, ensure that the clearances given in the following table are maintained. Failure to maintain these distances may cause deterioration in the performance of the Sensor.



#### Influence of Surrounding Metal

(Unit: mm)

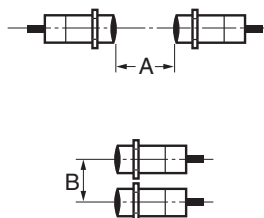
Model	Item	M8	M12	M18	M30	
DC 2-Wire Models E2E-X□D□	Shielded	l	0			
		d	8	12	18	30
		D	0			
		m	4.5	8	20	40
		n	12	18	27	45
		AC/DC 2-Wire Models E2E-X□T1	Unshielded	l	12	15
d	24			40	70	90
D	12			15	22	30
m	8			20	40	70
n	24			40	70	90
DC 3-Wire Models E2E-X□E□ E2E-X□F□ AC 2-Wire Models E2E-X□Y□	Shielded			l	0	
		d	8	12	18	30
		D	0			
		m	4.5	8	20	40
		n	12	18	27	45
		Unshielded	l	6	15	22
	d		24	40	55	90
	D		6	15	22	30
	m		8	20	40	70
	n		24	36	54	90
	Model		Item	3 dia.	4 dia.	M5
	DC 3-Wire Models E2E-X□C/B□ E2E-C□C/B□	Shielded	l	0		
d			3	4	5	5.4
D			0			
m			2	2.4	3	
n			6		8	

#### Relationship between Sizes and Models

Model	Model
3 dia.	E2E-CR6C/B
	E2E-CR8C□ E2E-CR8B□
4 dia.	E2E-X1C□ E2E-X1B□
	E2E-C1C□ E2E-C1B□
M5	E2E-X2D□ E2E-X1R5E□ E2E-X1R5F□ E2E-X1R5Y□
	E2E-X4MD□ E2E-X2ME□ E2E-X2MF□ E2E-X2MY□
5.4 dia.	E2E-X3D□ E2E-X2E□ E2E-X2F□ E2E-X2Y□ E2E-X3T1
	E2E-X8MD□ E2E-X5ME□ E2E-X5MF□ E2E-X5MY□
M8	E2E-X7D□ E2E-X5E□ E2E-X5F□ E2E-X5Y□ E2E-X7T1
	E2E-X14MD□ E2E-X10ME□ E2E-X10MF□ E2E-X10MY□
M12	E2E-X10D□ E2E-X10E□ E2E-X10F□ E2E-X10Y□ E2E-X10T1
	E2E-X20MD□ E2E-X18ME□ E2E-X18MF□ E2E-X18MY□
M18	
M30	

### Mutual Interference

When installing Sensors face-to-face or side-by-side, ensure that the minimum distances given in the following table are maintained.



### Mutual Interference

(Unit: mm)

Model	Item	M8	M12	M18	M30
DC 2-Wire Models E2E-X□D□	Shielded	A: 20 B: 15	30 (20) 20 (12)	50 (30) 35 (18)	100 (50) 70 (35)
	Unshielded	A: 80 B: 60	120 (60) 100 (50)	200 (100) 110 (60)	300 (100) 200 (100)
AC/DC 2-Wire Models E2E-X□T1	Shielded	A: 20 B: 15	30 (20) 20 (12)	50 (30) 35 (18)	100 (50) 70 (35)
	Unshielded	A: 80 B: 60	120 (60) 100 (50)	200 (100) 110 (60)	300 (100) 200 (100)

Model	Item	3 dia.	4 dia.	M5	5.4 dia.
DC 3-Wire Models E2E-X□C/B□ E2E-C□C/B□	Shielded	A: 20 B: 15	20		
			15		

Note: Values in parentheses apply to Sensors operating at different frequencies.

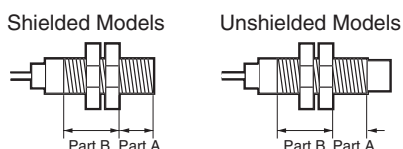
### Loads with Large Surge Currents (E2E-X□T□)

If a load with a large surge current is connected, such as a relay, lamp, or motor, the surge current may cause the load short-circuit protection circuit to operate, resulting in operating errors.

### ● Mounting

#### Tightening Force

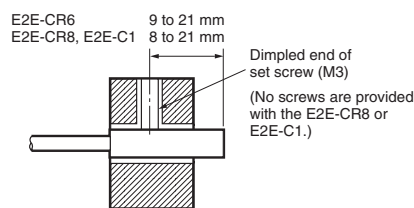
Do not tighten the nut with excessive force. A washer must be used with the nut.



- Note: 1. The allowable tightening strength depends on the distance from the edge of the head, as shown in the following table. (A is the distance from the edge of the head. B includes the nut on the head side. If the edge of the nut is in part A, the tightening torque for part A applies instead.)  
2. The following strengths assume washers are being used.

Model	Part A		Part B
	Dimension	Torque	Torque
M5		1 N·m	
M8	Shielded	9	12 N·m
	Unshielded	3	
M12		30 N·m	
M18		70 N·m	
M30		180 N·m	

Refer to the following to mount the E2E-CR6, E2E-CR8 and E2E-C1 Unthreaded Cylindrical Models.



When using a set screw, tighten it to a torque of 0.2 N·m max. (E2E-C1: 0.4 N·m max.)

### Connecting a DC 2-Wire Proximity Sensor to a PLC (Programmable Controller)

#### Required Conditions

Connection to a PLC is possible if the specifications of the PLC and the Proximity Sensor satisfy the following conditions. (The meanings of the symbols are given at the right.)

- The ON voltage of the PLC and the residual voltage of the Proximity Sensor must satisfy the following.  
 $V_{ON} \leq V_{CC} - V_R$
- The OFF current of the PLC and the leakage current of the Proximity Sensor must satisfy the following.  
 $I_{OFF} \geq I_{leak}$   
(If the OFF current is not listed in the PLC's input specifications, take it to be 1.3 mA.)
- The ON current of the PLC and the control output of the Proximity Sensor must satisfy the following.  
 $I_{OUT} (min.) \leq I_{ON} \leq I_{OUT} (max.)$   
The ON current of the PLC will vary, however, with the power supply voltage and the input impedance, as shown in the following equation.  
 $I_{ON} = (V_{CC} - V_R - V_{PC}) / R_{IN}$

$V_{ON}$ : ON voltage of PLC (14.4 V)
$I_{ON}$ : ON current of PLC (typically 7 mA)
$I_{OFF}$ : OFF current of PLC (1.3 mA)
$R_{IN}$ : Input impedance of PLC (3 kΩ)
$V_{PC}$ : Internal residual voltage of PLC (4 V)
$V_R$ : Output residual voltage of Proximity Sensor (3 V)
$I_{leak}$ : Leakage current of Proximity Sensor (0.8 mA)
$I_{OUT}$ : Control output of Proximity Sensor (3 to 100 mA)
$V_{CC}$ : Power supply voltage (PLC: 20.4 to 26.4 V)
Values in parentheses apply to the following PLC model and Proximity Sensor model.
PLC: C200H-ID212
Sensor: E2E-X7D1-N

#### Example

In this example, the above conditions are checked when the PLC Unit is the C200H-ID212, the Proximity Sensor is the E2E-X7D1-N, and the power supply voltage is 24 V.

- $V_{ON} (14.4 V) \leq V_{CC} (20.4 V) - V_R (3 V) = 17.4 V$ : OK
- $I_{OFF} (1.3 mA) \geq I_{leak} (0.8 mA)$ : OK
- $I_{ON} = [V_{CC} (20.4 V) - V_R (3 V) - V_{PLC} (4 V)] / R_{IN} (3 k\Omega) = \text{Approx. } 4.5 \text{ mA}$   
Therefore,  $I_{OUT} (min.) (3 mA) \leq I_{ON} (4.5 mA)$ : OK  
Connection is thus possible.

Dimensions

(Unit: mm)  
Tolerance class IT16 applies to dimensions in this data sheet unless otherwise specified.

Main Units

Model Number-Dimensions Drawing Number Lookup Table

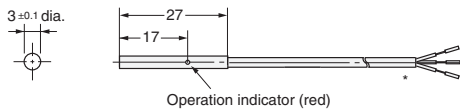
Model	Shielded	Model	DC 2-Wire Models		DC 3-Wire Models		AC 2-Wire Models		AC/DC 2-Wire Models			
		Model	No.	Model	No.	Model	No.	Model	No.			
Pre-wired Models	Shielded	3 dia.	---	---	E2E-CR6□	1	---	---	---	---		
		4 dia.			E2E-CR8□	2						
		M5			E2E-X1□	4						
		5.4 dia.			E2E-C1□	3						
	Unshielded	M8	E2E-X2D□	5	E2E-X1R5E□/F□	5	E2E-X1R5Y□	7	---	---		
		M12	E2E-X3D□	9	E2E-X2E□/F□	9	E2E-X2Y□	11			E2E-X3T1	13
		M18	E2E-X7D□	14	E2E-X5E□/F□	14	E2E-X5Y□	14			E2E-X7T1	14
		M30	E2E-X10D□	16	E2E-X10E□/F□	16	E2E-X10Y□	16			E2E-X10T1	16
		M8	E2E-X4MD□	6	E2E-X2ME□/F□	6	E2E-X2MY□	8			---	---
		M12	E2E-X8MD□	10	E2E-X5ME□/F□	10	E2E-X5MY□	12				
M18	E2E-X14MD□	15	E2E-X10ME□/F□	15	E2E-X10MY□	15						
M30	E2E-X20MD□	17	E2E-X18ME□/F□	17	E2E-X18MY□	17						
Connector Models (M12)	Shielded	M8	E2E-X2D□-M1(G)	18	E2E-X1R5E/F□-M1	18	---	---	---			
		M12	E2E-X3D□-M1(G)	20	E2E-X2E/F□-M1	20	E2E-X2Y□-M1			22		
		M18	E2E-X7D□-M1(G)	24	E2E-X5E/F□-M1	24	E2E-X5Y□-M1			24		
		M30	E2E-X10D□-M1(G)	26	E2E-X10E/F□-M1	26	E2E-X10Y□-M1			26		
	Unshielded	M8	E2E-X4MD□-M1(G)	19	E2E-X2ME/F□-M1	19	---	---	---			
		M12	E2E-X8MD□-M1(G)	21	E2E-X5ME/F□-M1	21	E2E-X5MY□-M1			23		
		M18	E2E-X14MD□-M1(G)	25	E2E-X10ME/F□-M1	25	E2E-X10MY□-M1			25		
		M30	E2E-X20MD□-M1(G)	27	E2E-X18ME/F□-M1	27	E2E-X18MY□-M1			27		
Connector Models (M8)	Shielded	M8	E2E-X2D□-M3G	28	E2E-X1R5E/F□-M3	28	---	---	---			
	Unshielded		E2E-X4MD□-M3G	29	E2E-X2ME/F□-M3	29						
Pre-wired Connector Models	Shielded	M8	E2E-X2D□-M1(T)GJ(-U)	30	---	---	---	---				
		M12	E2E-X3D□-M1(T)GJ(-U)	31								
		M18	E2E-X7D□-M1(T)GJ(-U)	33								
		M30	E2E-X10D□-M1(T)GJ(-U)	35								
	Unshielded	M12	E2E-X8MD1-M1(T)GJ	32	---	---	---	---				
		M18	E2E-X14MD1-M1(T)GJ	34								
		M30	E2E-X20MD1-M1(T)GJ	36								
Pre-wired Connector Models (no polarity)	Shielded	M12	E2E-X3D1-M1J-T	31	---	---	---	---				
		M18	E2E-X7D□-M1J-T	33								
		M30	E2E-X10D□-M1J-T	35								

Note 1. Two clamping nuts and one toothed washer are provided with M8 to M30 Models.  
2. The model numbers of M8 to M30 Pre-wired Models are laser-marked on the milled section and cable section. This does not apply, however, to models that end in -U.

Pre-wired Models (Shielded)



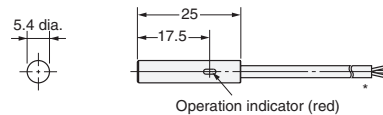
Diagram 1 E2E-CR6B□/CR6C□



\*2.4-dia. vinyl-insulated round cable with 3 conductors (Conductor cross section: 0.08 mm<sup>2</sup>, Insulator diameter: 0.7 mm)

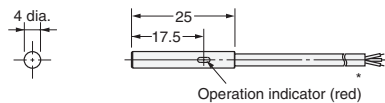


Diagram 3 E2E-C1B□/C1C□



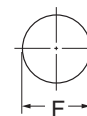
\*2.9-dia. vinyl-insulated round cable with 3 conductors (Conductor cross section: 0.14 mm<sup>2</sup>, Insulator diameter: 0.9 mm), Standard length: 2 m  
Robotics Cable Models:  
2.9-dia. vinyl-insulated round cable with 3 conductors (Conductor cross section: 0.15 mm<sup>2</sup>, Insulator diameter: 1.05 mm), Standard length: 2 m  
The cable can be extended up to 100 m (separate metal conduit).

Diagram 2 E2E-CR8B□/CR8C□



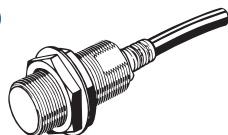
\*2.9-dia. vinyl-insulated round cable with 3 conductors (Conductor cross section: 0.14 mm<sup>2</sup>, Insulator diameter: 0.9 mm), Standard length: 2 m  
Robotics Cable Models:  
2.9-dia. vinyl-insulated round cable with 3 conductors (Conductor cross section: 0.15 mm<sup>2</sup>, Insulator diameter: 1.05 mm), Standard length: 2 m  
The cable can be extended up to 100 m (separate metal conduit).

Mounting Hole Dimensions

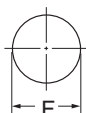


Dimension	3 dia.	4 dia.	5.4 dia.
F (mm)	3.3 <sup>+0.3</sup> <sub>0</sub> dia.	4.2 <sup>+0.5</sup> <sub>0</sub> dia.	5.7 <sup>+0.5</sup> <sub>0</sub> dia.

Pre-wired Models (Shielded)

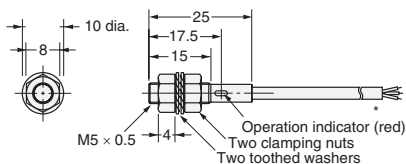


Mounting Hole Dimensions



Dimension	M5	M8	M12
F (mm)	5.5 <sup>+0.5</sup> <sub>0</sub> dia.	8.5 <sup>+0.5</sup> <sub>0</sub> dia.	12.5 <sup>+0.5</sup> <sub>0</sub> dia.

Diagram 4 E2E-X1B□/X1C□



\*2.9-dia. vinyl-insulated round cable with 3 conductors (Conductor cross section: 0.14 mm<sup>2</sup>, Insulator diameter: 0.9 mm), Standard length: 2 m  
 Robotics Cable Models:  
 2.9-dia. vinyl-insulated round cable with 3 conductors (Conductor cross section: 0.15 mm<sup>2</sup>, Insulator diameter: 1.05 mm), Standard length: 2 m  
 The cable can be extended up to 100 m (separate metal conduit).

Pre-wired Models (Unshielded)

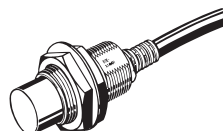
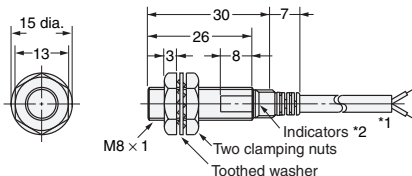
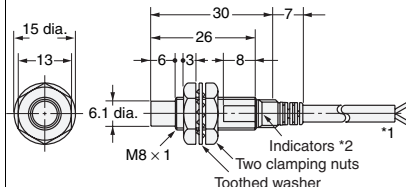


Diagram 5 E2E-X2D□  
E2E-X1R5E□/F□



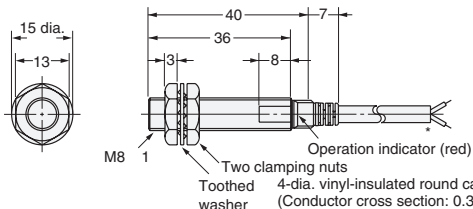
\*1. 4-dia. vinyl-insulated round cable with 2 conductors (Conductor cross section: 0.3 mm<sup>2</sup>, Insulator diameter: 1.3 mm), Standard length: 2 m  
 4-dia. vinyl-insulated round cable with 3 conductors (Conductor cross section: 0.3 mm<sup>2</sup>, Insulator diameter: 1.3 mm), Standard length: 2 m  
 Robotics Cable Models:  
 4-dia. vinyl-insulated round cable with 2 conductors (Conductor cross section: 0.3 mm<sup>2</sup>, Insulator diameter: 1.27 mm), Standard length: 2 m  
 4-dia. vinyl-insulated round cable with 3 conductors (Conductor cross section: 0.3 mm<sup>2</sup>, Insulator diameter: 1.27 mm), Standard length: 2 m  
 Models with Highly Oil-resistant Cables:  
 4-dia. polyurethane-insulated round cable with 2 conductors (Conductor cross section: 0.3 mm<sup>2</sup>, Insulator diameter: 1.3 mm), Standard length: 2 m  
 The cable can be extended up to 200 m (separate metal conduit).  
 \*2. D1 Models: Operation indicator (red) and setting indicator (green), D2/E/F Models: Operation indicator (red)

Diagram 6 E2E-X4MD□  
E2E-X2ME□/F□



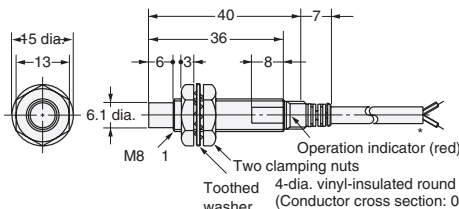
\*1. 4-dia. vinyl-insulated round cable with 2 conductors (Conductor cross section: 0.3 mm<sup>2</sup>, Insulator diameter: 1.3 mm), Standard length: 2 m  
 4-dia. vinyl-insulated round cable with 3 conductors (Conductor cross section: 0.3 mm<sup>2</sup>, Insulator diameter: 1.3 mm), Standard length: 2 m  
 Robotics Cable Models:  
 4-dia. vinyl-insulated round cable with 2 conductors (Conductor cross section: 0.3 mm<sup>2</sup>, Insulator diameter: 1.27 mm), Standard length: 2 m  
 4-dia. vinyl-insulated round cable with 3 conductors (Conductor cross section: 0.3 mm<sup>2</sup>, Insulator diameter: 1.27 mm), Standard length: 2 m  
 The cable can be extended up to 200 m (separate metal conduit).  
 \*2. D1 Models: Operation indicator (red) and setting indicator (green), D2/E/F Models: Operation indicator (red)

Diagram 7 E2E-X1R5Y□



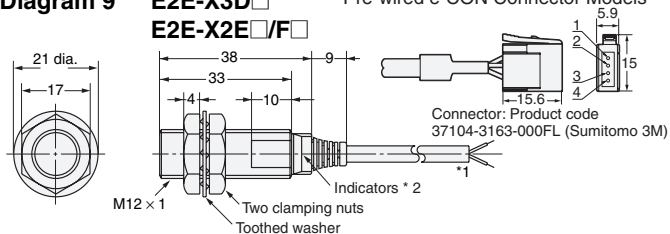
4-dia. vinyl-insulated round cable with 2 conductors (Conductor cross section: 0.3 mm<sup>2</sup>, Insulator diameter: 1.3 mm), Standard length: 2 m  
 The cable can be extended up to 200 m (separate metal conduit).

Diagram 8 E2E-X2MY□



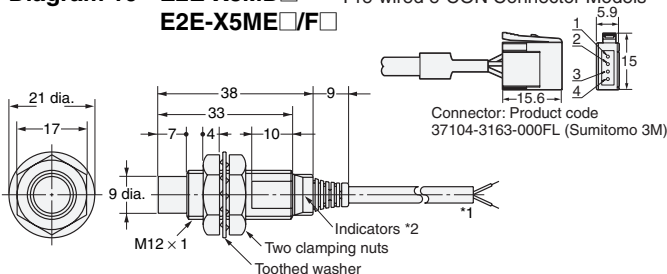
4-dia. vinyl-insulated round cable with 2 conductors (Conductor cross section: 0.3 mm<sup>2</sup>, Insulator diameter: 1.3 mm), Standard length: 2 m  
 The cable can be extended up to 200 m (separate metal conduit).

Diagram 9 E2E-X3D□ Pre-wired e-CON Connector Models  
E2E-X2E□/F□



\*1. 4-dia. vinyl-insulated round cable with 2 conductors (Conductor cross section: 0.3 mm<sup>2</sup>, Insulator diameter: 1.3 mm), Standard length: 2 m  
 4-dia. vinyl-insulated round cable with 3 conductors (Conductor cross section: 0.3 mm<sup>2</sup>, Insulator diameter: 1.3 mm), Standard length: 2 m  
 Robotics Cable Models:  
 4-dia. vinyl-insulated round cable with 2 conductors (Conductor cross section: 0.3 mm<sup>2</sup>, Insulator diameter: 1.27 mm), Standard length: 2 m  
 4-dia. vinyl-insulated round cable with 3 conductors (Conductor cross section: 0.3 mm<sup>2</sup>, Insulator diameter: 1.27 mm), Standard length: 2 m  
 Models with Highly Oil-resistant Cables:  
 4-dia. polyurethane-insulated round cable with 2 conductors (Conductor cross section: 0.3 mm<sup>2</sup>, Insulator diameter: 1.3 mm), Standard length: 2 m  
 The cable can be extended (separate metal conduit) up to 200 m for the control output and up to 100 m for the diagnostic output.  
 \*2. D1 Models: Operation indicator (red) and setting indicator (green), D2/E/F Models: Operation indicator (red)

Diagram 10 E2E-X8MD□ Pre-wired e-CON Connector Models  
E2E-X5ME□/F□



\*1. 4-dia. vinyl-insulated round cable with 2 conductors (Conductor cross section: 0.3 mm<sup>2</sup>, Insulator diameter: 1.3 mm), Standard length: 2 m  
 4-dia. vinyl-insulated round cable with 3 conductors (Conductor cross section: 0.3 mm<sup>2</sup>, Insulator diameter: 1.3 mm), Standard length: 2 m  
 Robotics Cable Models:  
 4-dia. vinyl-insulated round cable with 2 conductors (Conductor cross section: 0.3 mm<sup>2</sup>, Insulator diameter: 1.27 mm), Standard length: 2 m  
 4-dia. vinyl-insulated round cable with 3 conductors (Conductor cross section: 0.3 mm<sup>2</sup>, Insulator diameter: 1.27 mm), Standard length: 2 m  
 The cable can be extended (separate metal conduit) up to 200 m for the control output and up to 100 m for the diagnostic output.  
 \*2. D1 Models: Operation indicator (red) and setting indicator (green), D2/E/F Models: Operation indicator (red)

Diagram 11 E2E-X2Y□

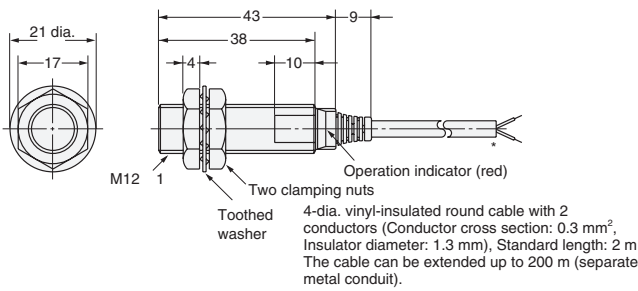
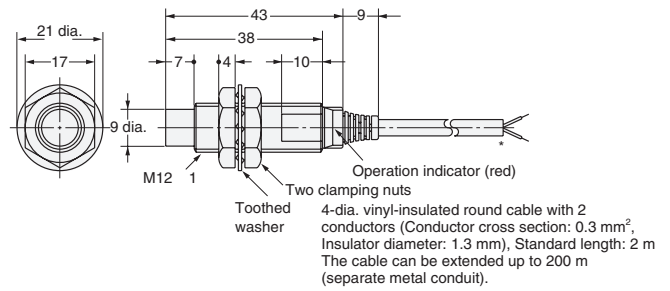


Diagram 12 E2E-X5MY□



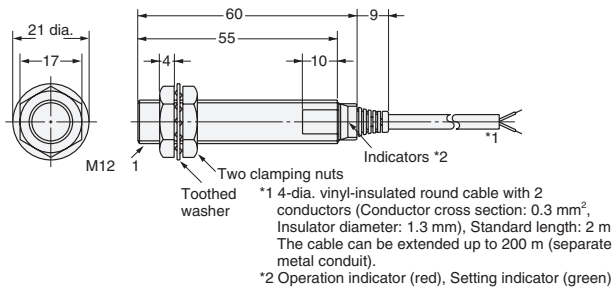
Pre-wired Models (Shielded)

Mounting Hole Dimensions



Dimension	M8	M12	M18	M30
F (mm)	8.5 <sup>+0.5</sup> dia.	12.5 <sup>+0.5</sup> dia.	18.5 <sup>+0.5</sup> dia.	30.5 <sup>+0.5</sup> dia.

Diagram 13 E2E-X3T1



Pre-wired Models (Unshielded)

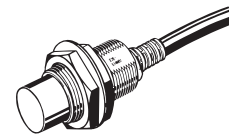
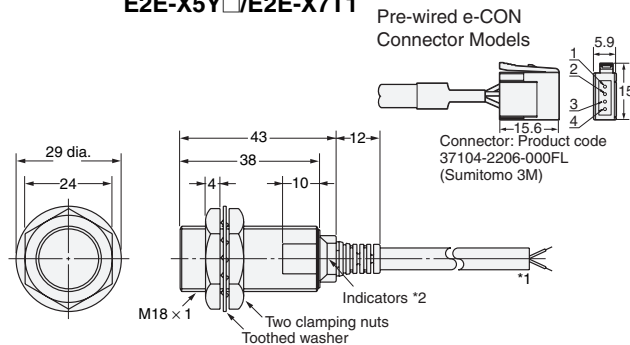
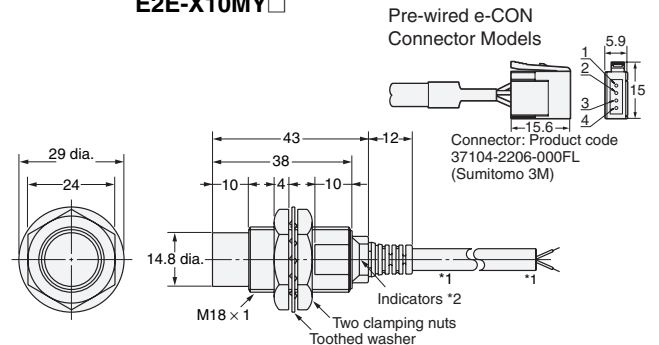


Diagram 14 E2E-X7D□/E2E-X5E□/F□  
E2E-X5Y□/E2E-X7T1



\*1. 6-dia. vinyl-insulated round cable with 2 conductors (Conductor cross section: 0.5 mm<sup>2</sup>, Insulator diameter: 1.9 mm), Standard length: 2 m  
6-dia. vinyl-insulated round cable with 3 conductors (Conductor cross section: 0.5 mm<sup>2</sup>, Insulator diameter: 1.9 mm), Standard length: 2 m  
Robotics Cable Models:  
6-dia. vinyl-insulated round cable with 2 conductors (Conductor cross section: 0.5 mm<sup>2</sup>, Insulator diameter: 1.74 mm), Standard length: 2 m  
6-dia. vinyl-insulated round cable with 3 conductors (Conductor cross section: 0.5 mm<sup>2</sup>, Insulator diameter: 1.74 mm), Standard length: 2 m  
Models with Highly Oil-resistant Cables:  
6-dia. polyurethane-insulated round cable with 2 conductors (Conductor cross section: 0.5 mm<sup>2</sup>, Insulator diameter: 1.9 mm), Standard length: 2 m  
The cable can be extended (separate metal conduit) up to 200 m for the control output and up to 100 m for the diagnostic output.  
\*2. D1/T Models: Operation indicator (red), Setting indicator (green)  
D2/E/F/Y Models: Operation indicator (red)

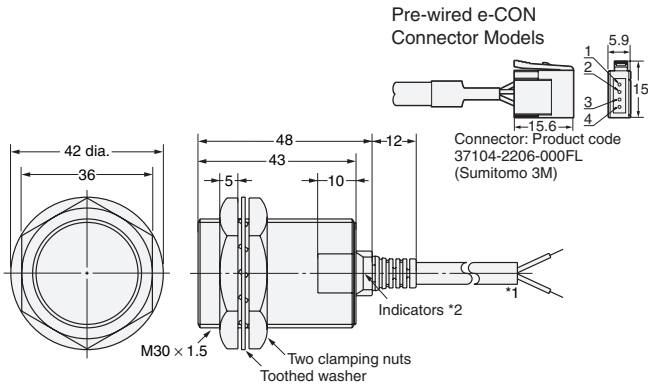
Diagram 15 E2E-X14MD□/E2E-X10ME□/F□  
E2E-X10MY□



\*1. 6-dia. vinyl-insulated round cable with 2 conductors (Conductor cross section: 0.5 mm<sup>2</sup>, Insulator diameter: 1.9 mm), Standard length: 2 m  
6-dia. vinyl-insulated round cable with 3 conductors (Conductor cross section: 0.5 mm<sup>2</sup>, Insulator diameter: 1.9 mm), Standard length: 2 m  
Robotics Cable Models:  
6-dia. vinyl-insulated round cable with 2 conductors (Conductor cross section: 0.5 mm<sup>2</sup>, Insulator diameter: 1.74 mm), Standard length: 2 m  
6-dia. vinyl-insulated round cable with 3 conductors (Conductor cross section: 0.5 mm<sup>2</sup>, Insulator diameter: 1.74 mm), Standard length: 2 m  
The cable can be extended (separate metal conduit) up to 200 m for the control output and up to 100 m for the diagnostic output.  
\*2. D1/T Models: Operation indicator (red), Setting indicator (green)  
D2/E/F/Y Models: Operation indicator (red)

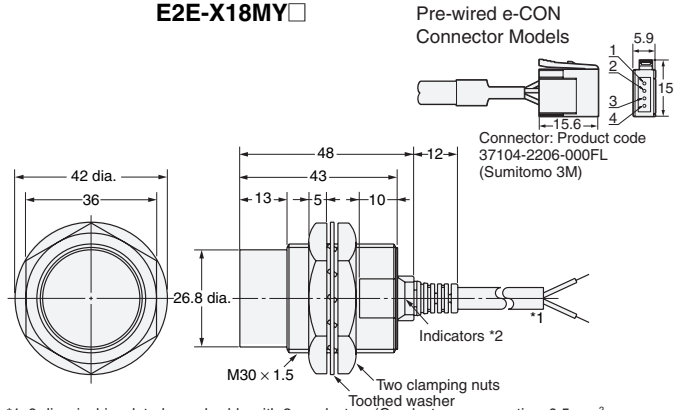


**Diagram 16** E2E-X10D□/E2E-X10E□/F□  
E2E-X10Y□/E2E-X10T1



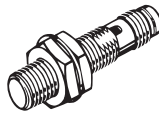
- \*1. 6-dia. vinyl-insulated round cable with 2 conductors (Conductor cross section: 0.5 mm<sup>2</sup>, Insulator diameter: 1.9 mm), Standard length: 2 m
- 6-dia. vinyl-insulated round cable with 3 conductors (Conductor cross section: 0.5 mm<sup>2</sup>, Insulator diameter: 1.9 mm), Standard length: 2 m
- Robotics Cable Models:
  - 6-dia. vinyl-insulated round cable with 2 conductors (Conductor cross section: 0.5 mm<sup>2</sup>, Insulator diameter: 1.74 mm), Standard length: 2 m
  - 6-dia. vinyl-insulated round cable with 3 conductors (Conductor cross section: 0.5 mm<sup>2</sup>, Insulator diameter: 1.74 mm), Standard length: 2 m
- Models with Highly Oil-resistant:
  - 6-dia. polyurethane-insulated round cable with 2 conductors (Conductor cross section: 0.5 mm<sup>2</sup>, Insulator diameter: 1.9 mm), Standard length: 2 m
- The cable can be extended (separate metal conduit) up to 200 m for the control output and up to 100 m for the diagnostic output.
- \*2. D1/T Models: Operation indicator (red), Setting indicator (green)
- D2/E/F/Y Models: Operation indicator (red)

**Diagram 17** E2E-X20MD□/E2E-X18ME□/F□  
E2E-X18MY□

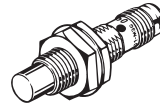


- \*1. 6-dia. vinyl-insulated round cable with 2 conductors (Conductor cross section: 0.5 mm<sup>2</sup>, Insulator diameter: 1.9 mm), Standard length: 2 m
- 6-dia. vinyl-insulated round cable with 3 conductors (Conductor cross section: 0.5 mm<sup>2</sup>, Insulator diameter: 1.9 mm), Standard length: 2 m
- Robotics Cable Models:
  - 6-dia. vinyl-insulated round cable with 2 conductors (Conductor cross section: 0.5 mm<sup>2</sup>, Insulator diameter: 1.74 mm), Standard length: 2 m
  - 6-dia. vinyl-insulated round cable with 3 conductors (Conductor cross section: 0.5 mm<sup>2</sup>, Insulator diameter: 1.74 mm), Standard length: 2 m
- The cable can be extended (separate metal conduit) up to 200 m for the control output and up to 100 m for the diagnostic output.
- \*2. D1/T Models: Operation indicator (red), Setting indicator (green)
- D2/E/F/Y Models: Operation indicator (red)

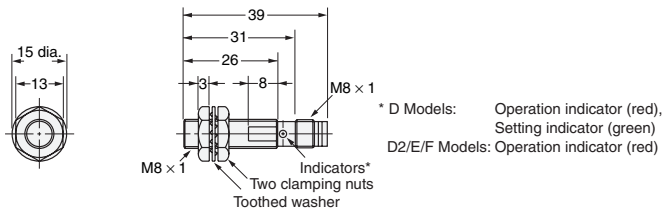
**M8 Connector Models (Shielded)**



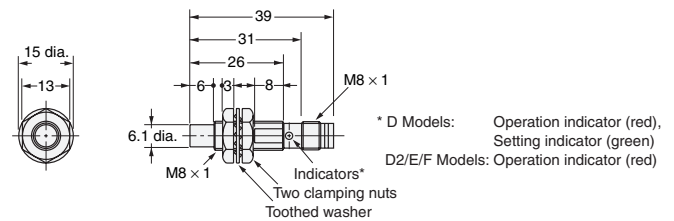
**M8 Connector Models (Unshielded)**



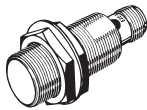
**Diagram 28** E2E-X2D□-M3G/E2E-X1R5E□-M3/X1RF□-M3



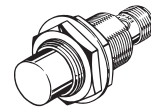
**Diagram 29** E2E-X4MD□-M3G/E2E-X2ME□-M3/X2MF□-M3



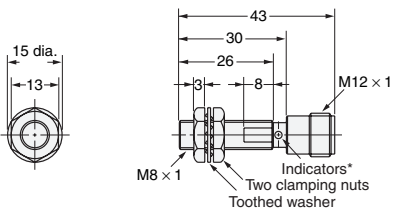
**M12 Connector Models (Shielded)**



**M12 Connector Models (Unshielded)**

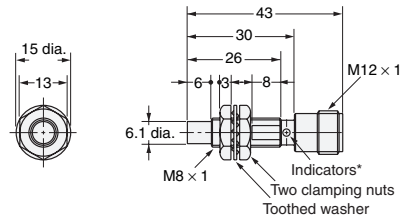


**Diagram 18** E2E-X2D□-M1(G)  
E2E-X1R5E□-M1/E2E-X1R5F□-M1



- \* D1 Models: Operation indicator (red), Setting indicator (green)
- D2/E/F Models: Operation indicator (red)

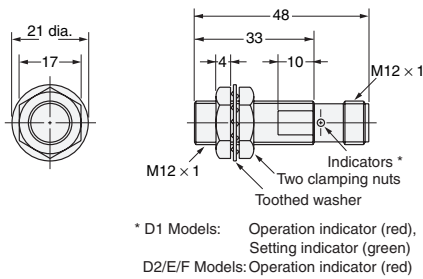
**Diagram 19** E2E-X4MD□-M1(G)  
E2E-X2ME□-M1/E2E-X2MF□-M1



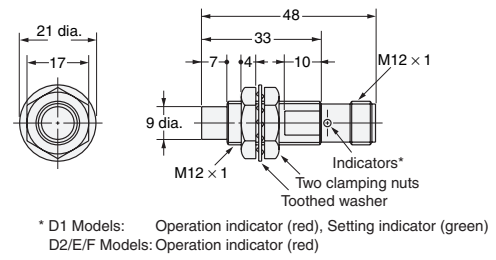
- \* D1 Models: Operation indicator (red), Setting indicator (green)
- D2/E/F Models: Operation indicator (red)



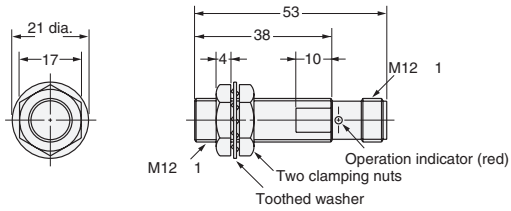
**Diagram 20 E2E-X3D□-M1(G)  
E2E-X2E□-M1/E2E-X2F□-M1**



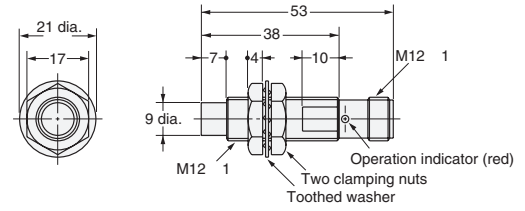
**Diagram 21 E2E-X8MD□-M1(G)  
E2E-X5ME□-M1/E2E-X5MF□-M1**



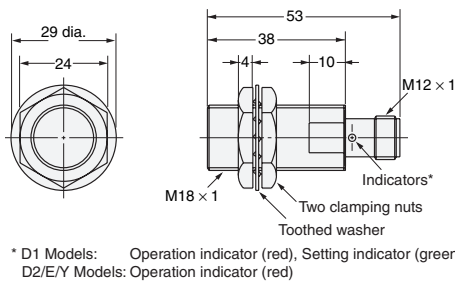
**Diagram 22 E2E-X2Y□-M1**



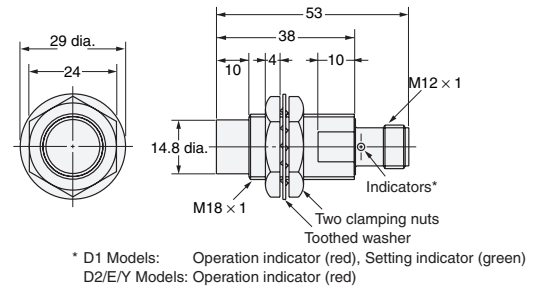
**Diagram 23 E2E-X5MY□-M1**



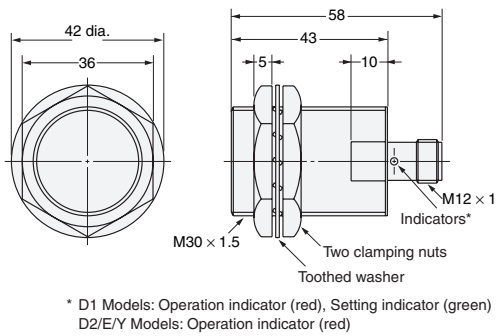
**Diagram 24 E2E-X7D□-M1(G)/E2E-X5E□-M1/X5F□-M1  
E2E-X5Y□-M1**



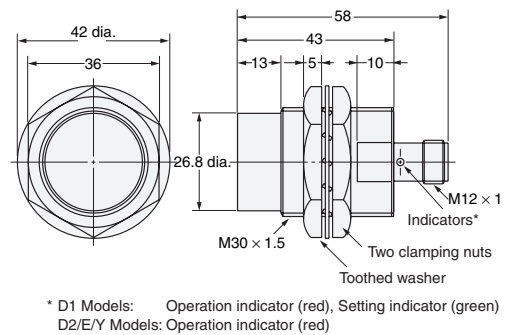
**Diagram 25 E2E-X14MD□-M1(G)/E2E-X10ME□-M1  
X10MF□-M1  
E2E-X10MY□-M1**



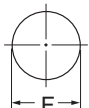
**Diagram 26 E2E-X10D□-M1(G)/E2E-X10E□-M1/X10F□-M1  
E2E-X10Y□-M1**



**Diagram 27 E2E-X20MD□-M1(G)/E2E-X18ME□-M1/  
X18MF□-M1  
E2E-X18MY□-M1**



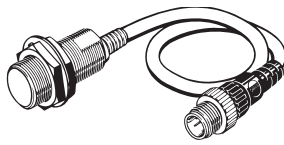
**Mounting Hole Dimensions**



Dimensions	M8	M12	M18	M30
F (mm)	8.5 <sup>+0.5</sup> <sub>0</sub> dia.	12.5 <sup>+0.5</sup> <sub>0</sub> dia.	18.5 <sup>+0.5</sup> <sub>0</sub> dia.	30.5 <sup>+0.5</sup> <sub>0</sub> dia.

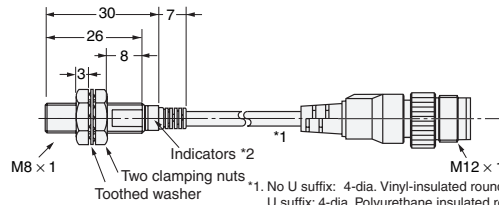
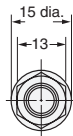
Pre-wired Connector Models (Shielded)

Mounting Hole Dimensions



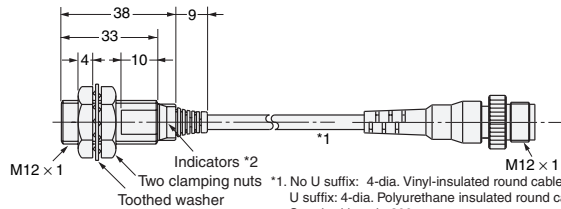
Dimension	M12	M18	M30
F (mm)	12.5 <sup>+0.5</sup> <sub>0</sub> dia.	18.5 <sup>+0.5</sup> <sub>0</sub> dia.	30.5 <sup>+0.5</sup> <sub>0</sub> dia.

Diagram 30 E2E-X2D□-M1TGJ-U \*3  
E2E-X2D1-M1TGJ



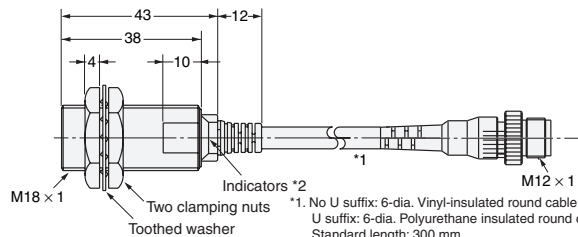
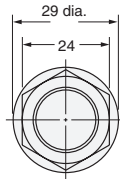
\*1. No U suffix: 4-dia. Vinyl-insulated round cable  
U suffix: 4-dia. Polyurethane insulated round cable,  
Standard length: 300 mm  
\*2. D1 Models: Operation indicator (red), Setting indicator (green)  
D2 Models: Operation indicator (red)  
\*3. The connectors for M1TGJ models are XS5 Smartclick connectors.

Diagram 31 E2E-X3D□-M1GJ  
E2E-X3D1-M1J-T  
E2E-X3D□-M1TGJ-U \*3  
E2E-X3D1-M1TGJ



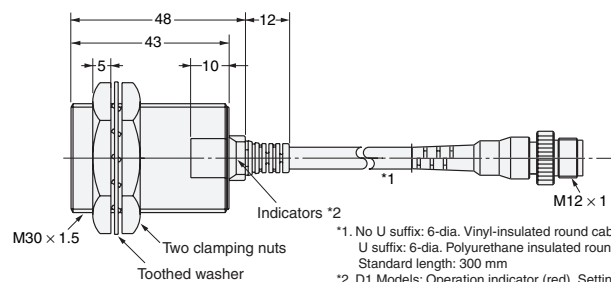
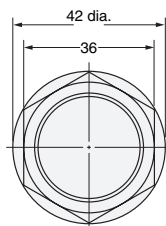
\*1. No U suffix: 4-dia. Vinyl-insulated round cable  
U suffix: 4-dia. Polyurethane insulated round cable,  
Standard length: 300 mm  
\*2. D1 Models: Operation indicator (red), Setting indicator (green)  
D2 Models: Operation indicator (red)  
\*3. The connectors for M1TGJ models are XS5 Smartclick connectors.

Diagram 33 E2E-X7D□-M1GJ  
E2E-X7D□-M1J-T  
E2E-X7D□-M1TGJ-U \*3  
E2E-X7D1-M1TGJ



\*1. No U suffix: 6-dia. Vinyl-insulated round cable  
U suffix: 6-dia. Polyurethane insulated round cable,  
Standard length: 300 mm  
\*2. D1 Models: Operation indicator (red), Setting indicator (green)  
D2 Models: Operation indicator (red)  
\*3. The connectors for M1TGJ models are XS5 Smartclick connectors.

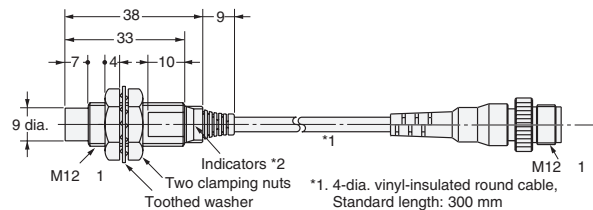
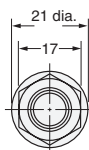
Diagram 35 E2E-X10D□-M1GJ  
E2E-X10D□-M1J-T  
E2E-X10D□-M1TGJ-U \*3  
E2E-X10D1-M1TGJ



\*1. No U suffix: 6-dia. Vinyl-insulated round cable  
U suffix: 6-dia. Polyurethane insulated round cable,  
Standard length: 300 mm  
\*2. D1 Models: Operation indicator (red), Setting indicator (green)  
D2 Models: Operation indicator (red)  
\*3. The connectors for M1TGJ models are XS5 Smartclick connectors.

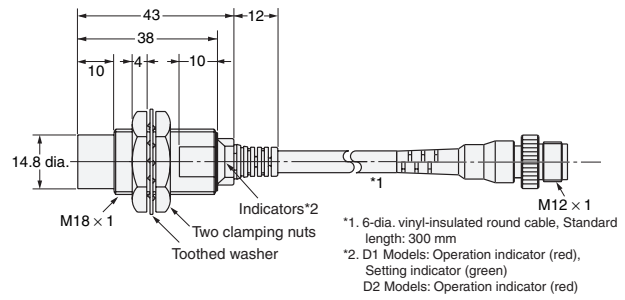
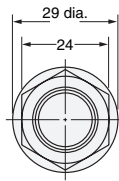
Pre-wired Connector Models (Unshielded)

Diagram 32 E2E-X8MD1-M1GJ  
E2E-X8MD1-M1TGJ

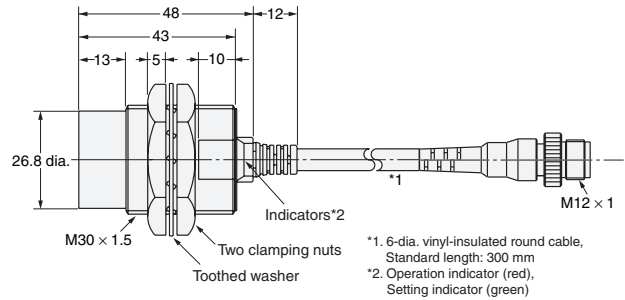
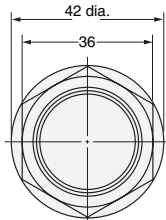


\*1. 4-dia. vinyl-insulated round cable,  
Standard length: 300 mm  
\*2. Operation indicator (red), Setting  
indicator (green)

**Diagram 34** E2E-X14MD□-M1GJ  
E2E-X14MD1-M1TGJ

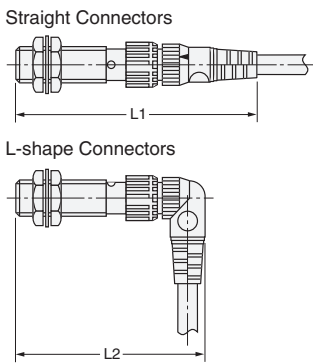


**Diagram 36** E2E-X20MD1-M1GJ  
E2E-X20MD1-M1TGJ

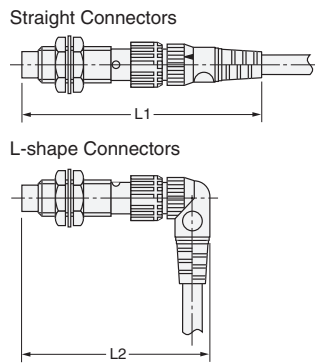


**Dimensions for Proximity Sensors with Sensor I/O Connectors**

**Shielded Models**



**Unshielded Models**



**Dimensions with the XS2F Connected (Unit: mm)**

Dimension		L1	L2
Sensor diameter			
M8		Approx. 75	Approx. 62
M12*	DC	Approx. 80	Approx. 67
	AC	Approx. 85	Approx. 72
M18		Approx. 85	Approx. 72
M30		Approx. 90	Approx. 77

\* The overall length of the Sensor is different between AC and DC Models for Sensors with diameters of M12. This will change the dimension when the I/O Connector is connected.

**Dimensions with the XS3F Connected (Unit: mm)**

Dimension		L1	L2
Sensor diameter			
M8		Approx. 65	Approx. 54

**Accessories (Order Separately)**

**Sensor I/O Connectors**

Refer to *Introduction to Sensor I/O Connectors* for details.

- Mounting Brackets**
- Protective Covers**
- Sputter Protective Covers**

Refer to Y92□ for details.

## Read and Understand This Catalog

Please read and understand this catalog before purchasing the products. Please consult your OMRON representative if you have any questions or comments.

## Warranty and Limitations of Liability

### WARRANTY

OMRON's exclusive warranty is that the products are free from defects in materials and workmanship for a period of one year (or other period if specified) from date of sale by OMRON.

OMRON MAKES NO WARRANTY OR REPRESENTATION, EXPRESS OR IMPLIED, REGARDING NON-INFRINGEMENT, MERCHANTABILITY, OR FITNESS FOR PARTICULAR PURPOSE OF THE PRODUCTS. ANY BUYER OR USER ACKNOWLEDGES THAT THE BUYER OR USER ALONE HAS DETERMINED THAT THE PRODUCTS WILL SUITABLY MEET THE REQUIREMENTS OF THEIR INTENDED USE. OMRON DISCLAIMS ALL OTHER WARRANTIES, EXPRESS OR IMPLIED.

### LIMITATIONS OF LIABILITY

OMRON SHALL NOT BE RESPONSIBLE FOR SPECIAL, INDIRECT, OR CONSEQUENTIAL DAMAGES, LOSS OF PROFITS OR COMMERCIAL LOSS IN ANY WAY CONNECTED WITH THE PRODUCTS, WHETHER SUCH CLAIM IS BASED ON CONTRACT, WARRANTY, NEGLIGENCE, OR STRICT LIABILITY.

In no event shall the responsibility of OMRON for any act exceed the individual price of the product on which liability is asserted.

IN NO EVENT SHALL OMRON BE RESPONSIBLE FOR WARRANTY, REPAIR, OR OTHER CLAIMS REGARDING THE PRODUCTS UNLESS OMRON'S ANALYSIS CONFIRMS THAT THE PRODUCTS WERE PROPERLY HANDLED, STORED, INSTALLED, AND MAINTAINED AND NOT SUBJECT TO CONTAMINATION, ABUSE, MISUSE, OR INAPPROPRIATE MODIFICATION OR REPAIR.

## Application Considerations

### SUITABILITY FOR USE

OMRON shall not be responsible for conformity with any standards, codes, or regulations that apply to the combination of products in the customer's application or use of the products.

At the customer's request, OMRON will provide applicable third party certification documents identifying ratings and limitations of use that apply to the products. This information by itself is not sufficient for a complete determination of the suitability of the products in combination with the end product, machine, system, or other application or use.

The following are some examples of applications for which particular attention must be given. This is not intended to be an exhaustive list of all possible uses of the products, nor is it intended to imply that the uses listed may be suitable for the products:

- Outdoor use, uses involving potential chemical contamination or electrical interference, or conditions or uses not described in this catalog.
- Nuclear energy control systems, combustion systems, railroad systems, aviation systems, medical equipment, amusement machines, vehicles, safety equipment, and installations subject to separate industry or government regulations.
- Systems, machines, and equipment that could present a risk to life or property.

Please know and observe all prohibitions of use applicable to the products.

NEVER USE THE PRODUCTS FOR AN APPLICATION INVOLVING SERIOUS RISK TO LIFE OR PROPERTY WITHOUT ENSURING THAT THE SYSTEM AS A WHOLE HAS BEEN DESIGNED TO ADDRESS THE RISKS, AND THAT THE OMRON PRODUCTS ARE PROPERLY RATED AND INSTALLED FOR THE INTENDED USE WITHIN THE OVERALL EQUIPMENT OR SYSTEM.

### PROGRAMMABLE PRODUCTS

OMRON shall not be responsible for the user's programming of a programmable product, or any consequence thereof.

## Disclaimers

### CHANGE IN SPECIFICATIONS

Product specifications and accessories may be changed at any time based on improvements and other reasons.

It is our practice to change model numbers when published ratings or features are changed, or when significant construction changes are made. However, some specifications of the products may be changed without any notice. When in doubt, special model numbers may be assigned to fix or establish key specifications for your application on your request. Please consult with your OMRON representative at any time to confirm actual specifications of purchased products.

### DIMENSIONS AND WEIGHTS

Dimensions and weights are nominal and are not to be used for manufacturing purposes, even when tolerances are shown.

### PERFORMANCE DATA

Performance data given in this catalog is provided as a guide for the user in determining suitability and does not constitute a warranty. It may represent the result of OMRON's test conditions, and the users must correlate it to actual application requirements. Actual performance is subject to the OMRON Warranty and Limitations of Liability.

### ERRORS AND OMISSIONS

The information in this document has been carefully checked and is believed to be accurate; however, no responsibility is assumed for clerical, typographical, or proofreading errors, or omissions.

2010.8

In the interest of product improvement, specifications are subject to change without notice.

**OMRON Corporation**  
Industrial Automation Company

<http://www.ia.omron.com/>

(c)Copyright OMRON Corporation 2010 All Right Reserved.

Компания «Океан Электроники» предлагает заключение долгосрочных отношений при поставках импортных электронных компонентов на взаимовыгодных условиях!

Наши преимущества:

- Поставка оригинальных импортных электронных компонентов напрямую с производств Америки, Европы и Азии, а так же с крупнейших складов мира;
- Широкая линейка поставок активных и пассивных импортных электронных компонентов (более 30 млн. наименований);
- Поставка сложных, дефицитных, либо снятых с производства позиций;
- Оперативные сроки поставки под заказ (от 5 рабочих дней);
- Экспресс доставка в любую точку России;
- Помощь Конструкторского Отдела и консультации квалифицированных инженеров;
- Техническая поддержка проекта, помощь в подборе аналогов, поставка прототипов;
- Поставка электронных компонентов под контролем ВП;
- Система менеджмента качества сертифицирована по Международному стандарту ISO 9001;
- При необходимости вся продукция военного и аэрокосмического назначения проходит испытания и сертификацию в лаборатории (по согласованию с заказчиком);
- Поставка специализированных компонентов военного и аэрокосмического уровня качества (Xilinx, Altera, Analog Devices, Intersil, Interpoint, Microsemi, Actel, Aeroflex, Peregrine, VPT, Syfer, Eurofarad, Texas Instruments, MS Kennedy, Miteq, Cobham, E2V, MA-COM, Hittite, Mini-Circuits, General Dynamics и др.);

Компания «Океан Электроники» является официальным дистрибьютором и эксклюзивным представителем в России одного из крупнейших производителей разъемов военного и аэрокосмического назначения «JONHON», а так же официальным дистрибьютором и эксклюзивным представителем в России производителя высокотехнологичных и надежных решений для передачи СВЧ сигналов «FORSTAR».



## JONHON

«JONHON» (основан в 1970 г.)

Разъемы специального, военного и аэрокосмического назначения:

(Применяются в военной, авиационной, аэрокосмической, морской, железнодорожной, горно- и нефтедобывающей отраслях промышленности)

«FORSTAR» (основан в 1998 г.)

ВЧ соединители, коаксиальные кабели, кабельные сборки и микроволновые компоненты:

(Применяются в телекоммуникациях гражданского и специального назначения, в средствах связи, РЛС, а так же военной, авиационной и аэрокосмической отраслях промышленности).



Телефон: 8 (812) 309-75-97 (многоканальный)

Факс: 8 (812) 320-03-32

Электронная почта: [ocean@oceanchips.ru](mailto:ocean@oceanchips.ru)

Web: <http://oceanchips.ru/>

Адрес: 198099, г. Санкт-Петербург, ул. Калинина, д. 2, корп. 4, лит. А