

**2S1-Series**  
Sub-Miniature Toggle Switch

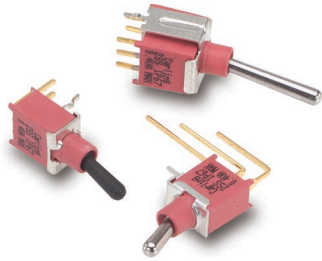

**2SS-Series**  
**Sealed** Sub-Miniature Toggle Switch

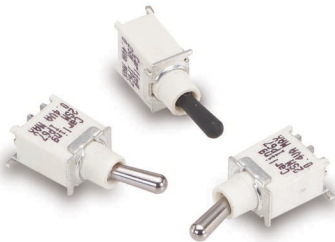

**2SM-Series**  
**Sealed Surface Mount** Sub-Miniature Toggle Switch

### 2S1-Series Ordering Scheme

2S1 - MSP 1 - T1 - B4 - M6 Q E

1 Series
2 Poles
3 Circuit
4 Actuator Style
5 Bushing
6 Termination
7 Contact
8 Seal

**1 SERIES**  
2S1 Sub-Miniature Toggle Switch

**2 POLES**  
MSP single pole - uses terminals 1, 2 & 3.  
MDP double pole uses terminals 1,2, 3, 4, 5 & 6.

**3 CIRCUIT**  
( ) - momentary

	<b>Switching Position:</b>		
	2-3, 5-6		
1	ON	OPEN	2-1, 5-4
2	ON	NONE	ON
3	ON	NONE	(ON)
4	(ON)	OFF	(ON)
5	ON	OFF	(ON)

**4 ACTUATOR STYLE**

<b>T1</b>	Round toggle .358 length	<b>T3</b>	Round toggle .299 length
<b>T2</b>	Round toggle .220 length	<b>T4</b>	Round toggle .433 length

**5 BUSHING<sup>1</sup>**

<b>B1</b>	Threaded Standard, keyway	Note: 1 All Switches come with standard nut, washer and locking ring shipped bulk. B5 & B7 bushing styles use small locking ring.
<b>B2</b>	Non-Threaded Standard, keyway	
<b>B3</b>	Threaded Short, keyway	
<b>B4</b>	Non-Threaded Short, keyway	
<b>B5</b>	High Torque, 7.5mm, flat	
<b>B6</b>	High Torque, 8.0mm, keyway	
<b>B7</b>	Long threaded	
<b>B8</b>	Metric	

### Specifications

Contact Rating . . . . . refer to ordering scheme  
 Electrical Life . . . . . 30,000 make & break cycles @ full load  
 Contact Resistance. . . . . 20 mΩ max. initial @ 2-4 VDC  
 100mA for both silver & gold plated contacts.  
 Insulation Resistance . . . . . 1000 MΩ min.  
 Dielectric Strength . . . . . 1500 Volts RMS @ sea level  
 Operating Temperature . . . . . -30°C to +85°C  
 Index of Protection . . . . . **2SS & 2SM-Series:** IP67  
 Solder Heat Resistance. . . . . MIL-STD-202, Method 210  
 Actuator Travel . . . . . 25°

**Materials**  
 Case . . . . . all UL 94 V-0  
*2S1-Series:* Diallyl phthalate (DAP)  
*2SS-Series:* Glass filled nylon 6/6, flame retardant, heat stabilized  
*2SM-Series:* Glass filled nylon 4/6, flame retardant, heat stabilized  
 Toggle. . . . . *2S1-Series:* Brass, chrome plated.  
*2SS & 2SM-Series:* Brass, chrome plated or nylon, internal o-ring sealed  
 Bushing . . . . . *2S1-Series:* Brass, nickel plated  
*2SS-Series:* Glass filled nylon 6/6, flame retardant, heat stabilized (UL 94V-0)  
*2SM-Series:* Glass filled nylon 4/6, flame retardant, heat stabilized (UL 94V-0)  
 Housing. . . . . Stainless Steel  
 Switch Support . . . . . Brass, tin plated  
 Terminal Seal . . . . . Epoxy

**6 TERMINATION**

<b>M1</b>	Solder Lug
<b>M2</b>	PCB
<b>M6</b>	PC Mount, 90° horizontal
<b>M7</b>	PC Mount, 90° vertical
<b>VS2</b>	PC Mount, U bracket, .620 mounting x .460 high
<b>VS3</b>	PC Mount, U bracket, .620 mounting x .630 high
<b>VS21</b>	Snap-In, U bracket

**7 CONTACT**

	<i>Material</i>	<i>Terminal Plating</i>	<i>Rating</i>	<i>Approvals</i>
<b>G</b>	silver <sup>1</sup>	gold over silver <sup>3</sup>	3A@125VAC or 28VDC, 1.5A @ 250VAC	UL CSA
<b>K</b>	gold <sup>2</sup>	tin-lead <sup>4</sup>	0.4VA max. @20V max (AC/DC)	-
<b>P</b>	silver <sup>1</sup>	tin-lead <sup>4</sup>	3A@125VAC or 28VDC, 1.5A @ 250VAC	UL CSA
<b>Q</b>	silver <sup>1</sup>	silver <sup>1</sup>	3A@125VAC or 28VDC, 1.5A @ 250VAC	UL CSA
<b>R</b>	gold <sup>2</sup>	gold <sup>2</sup>	0.4VA max. @20V max (AC/DC)	-

**NOTE:**  
 Tin-lead option available with PC type terminations only.  
 1 Moveable contact & terminals: copper alloy, silver plate  
 2 Moveable contact & terminals: copper alloy with gold plated over nickel plate  
 3 Terminals: silver plate with outer layer in gold plating  
 4 Outer terminals: copper alloy with tin-lead over nickel plate

**8 EPOXY SEAL**  
**E** epoxy seal

### 2SS-Series Ordering Scheme



**1 SERIES**  
**2SS** Sealed Sub-Miniature Toggle Switch

**2 POLES**  
**MSP** single pole - uses terminals 1, 2 & 3.  
**MDP** double pole uses terminals 1,2, 3, 4, 5 & 6.

**3 CIRCUIT**  
 ( ) - momentary

<b>Switching Position:</b>			
	2-3, 5-6	OPEN	2-1, 5-4
<b>1</b>	ON	NONE	ON
<b>2</b>	ON	NONE	(ON)
<b>3</b>	ON	OFF	ON
<b>4</b>	(ON)	OFF	(ON)
<b>5</b>	ON	OFF	(ON)

**4 ACTUATOR STYLE**

<b>T1</b> Round toggle .358 length	<b>P1</b> ESD resistant plastic toggle .421 length
<b>T2</b> Round toggle .220 length	<b>P2</b> ESD resistant plastic toggle .272 length
<b>T3</b> Round toggle .299 length	
<b>T4</b> Round toggle .433 length	

**5 BUSHING**  
**B4** Unthreaded bushing

**6 TERMINATION**

<b>M2</b>	PCB
<b>M6</b>	PC Mount, 90° horizontal
<b>M61</b>	Snap-In PC Mount, 90° horizontal
<b>M7</b>	PC Mount, 90° vertical
<b>M71</b>	Snap-In PC Mount, 90° vertical
<b>VS2</b>	PC Mount, U bracket, .620 mounting x .460 high
<b>VS21</b>	Snap-In, U bracket

**7 CONTACT**

	<i>Material</i>	<i>Terminal Plating</i>	<i>Rating</i>	
<b>G</b>	silver <sup>1</sup>	gold over silver <sup>3</sup>	3A@125VAC or 28VDC, 1.5A @ 250VAC	IP67
<b>K</b>	gold <sup>2</sup>	tin-lead plated <sup>4</sup>	0.4VA max. @20V max (AC/DC)	IP67
<b>P</b>	silver <sup>1</sup>	tin-lead plated <sup>4</sup>	3A@125VAC or 28VDC, 1.5A @ 250VAC	IP67
<b>R</b>	gold <sup>2</sup>	gold plated <sup>2</sup>	0.4VA max. @20V max (AC/DC)	IP67

NOTE:  
 Tin-lead option available with PC type terminations only.  
 1 Moveable contact & terminals: copper alloy, silver plate  
 2 Moveable contact & terminals: copper alloy with gold plate over nickel plate  
 3 Terminals: silver plate with outer layer in gold plating  
 4 Outer terminals: copper alloy with tin-lead over nickel plate

**8 EPOXY SEAL**  
**E** epoxy seal

### 2SM-Series Ordering Scheme



**1 SERIES**  
**2SM** Sealed Surface Mount Sub-Miniature Toggle Switch

**2 POLES**  
**MSP** single pole - uses terminals 1, 2 & 3.

**3 CIRCUIT**  
 ( ) - momentary

<b>Switching Position:</b>			
	2-3	OPEN	2-1
<b>1</b>	ON	NONE	ON
<b>2</b>	ON	NONE	(ON)
<b>3</b>	ON	OFF	ON
<b>4</b>	(ON)	OFF	(ON)
<b>5</b>	ON	OFF	(ON)

**4 ACTUATOR STYLE**

<b>T1</b> Round toggle .358 length	
<b>T2</b> Round toggle .220 length	
<b>P1</b> ESD resistant plastic toggle .421 length	
<b>P2</b> ESD resistant plastic toggle .272 length	

**5 TERMINATION**

<b>M6</b>	Surface Mount, 90° flat
<b>M7</b>	Surface Mount, 90° vertical
<b>S6</b>	Surface Mount, 90° horizontal

**6 CONTACT**

	<i>Material</i>	<i>Terminal Plating</i>	<i>Rating</i>	
<b>G</b>	silver <sup>1</sup>	gold over silver <sup>3</sup>	3A@125VAC or 28VDC, 1.5A @ 250VAC	IP67
<b>K</b>	gold <sup>2</sup>	tin-lead plated <sup>4</sup>	0.4VA max. @20V max (AC/DC)	IP67
<b>P</b>	silver <sup>1</sup>	tin-lead plated <sup>4</sup>	3A@125VAC or 28VDC, 1.5A @ 250VAC	IP67
<b>R</b>	gold <sup>2</sup>	gold plated <sup>2</sup>	0.4VA max. @20V max (AC/DC)	IP67

NOTE:  
 Tin-lead option available with PC type terminations only.  
 1 Moveable contact & terminals: copper alloy, silver plate  
 2 Moveable contact & terminals: copper alloy with gold plate over nickel plate  
 3 Terminals: silver plate with outer layer in gold plating  
 4 Outer terminals: copper alloy with tin-lead over nickel plate

**7 EPOXY SEAL**  
**E** epoxy seal

**8 PACKAGING**  
 Switches are bulk packed, unless **T/R** is specified at the end of the part number.  
**T/R** tape reel - 500 pieces per reel

**2S-Series Dimensional Specifications: in. [mm]**

**2S1-Series**

**ACTUATOR**

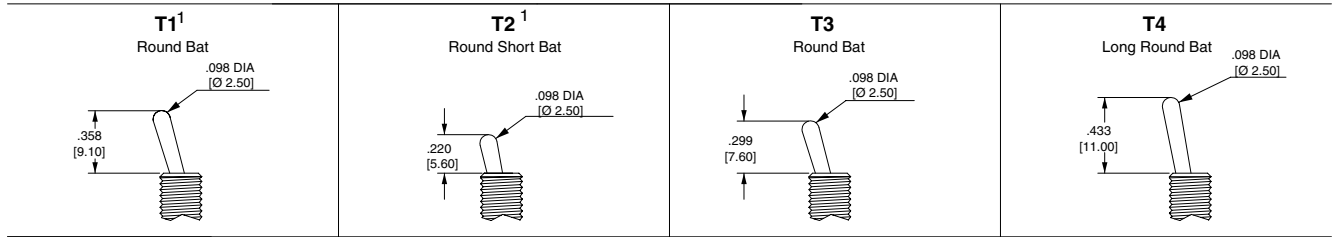

**BUSHING**

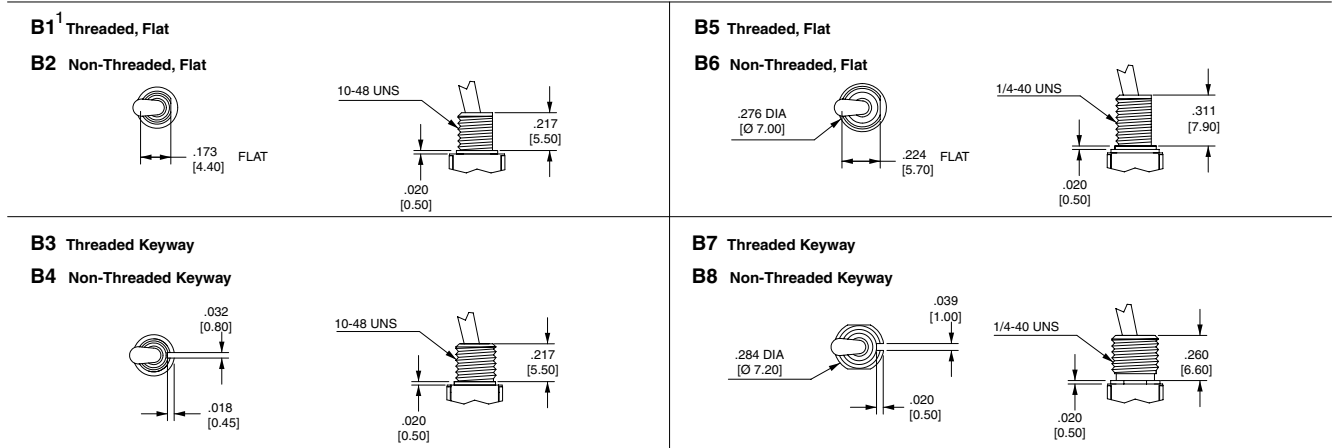

**PANEL MOUNTING**

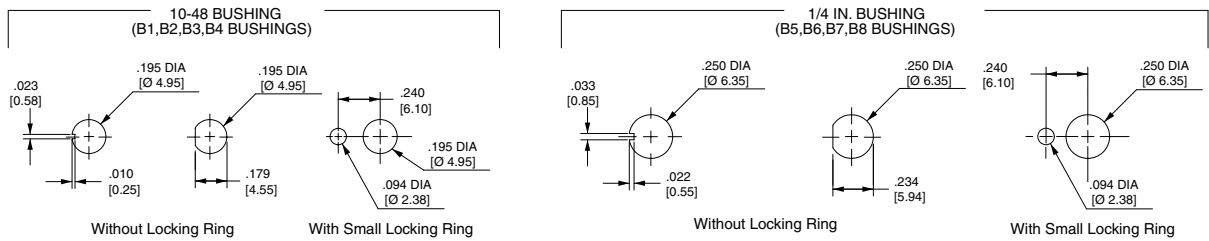

**2SS-Series**

**ACTUATOR**

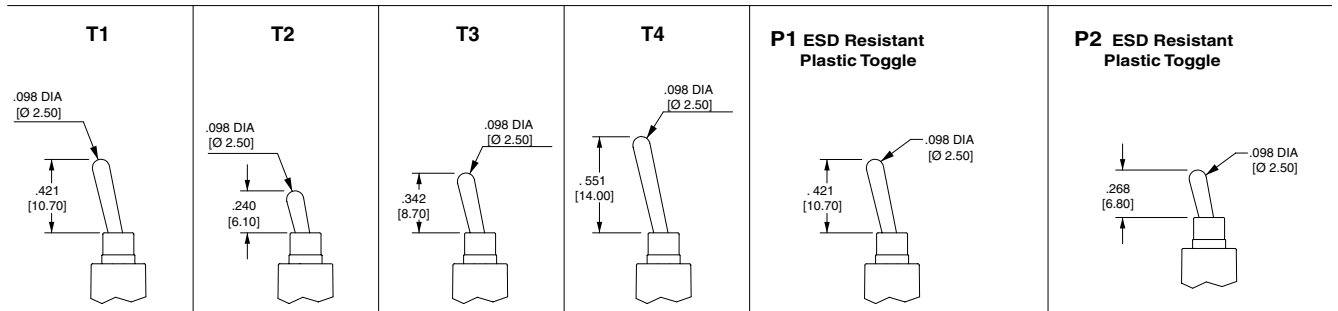

**BUSHING**

**B4**

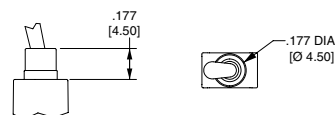

NOTE:  
1 Subtract 2.55mm from toggle length for B1 bushing.

**2S-Series Dimensional Specifications: in. [mm]**

**TERMINATION**

**2S1-Series**

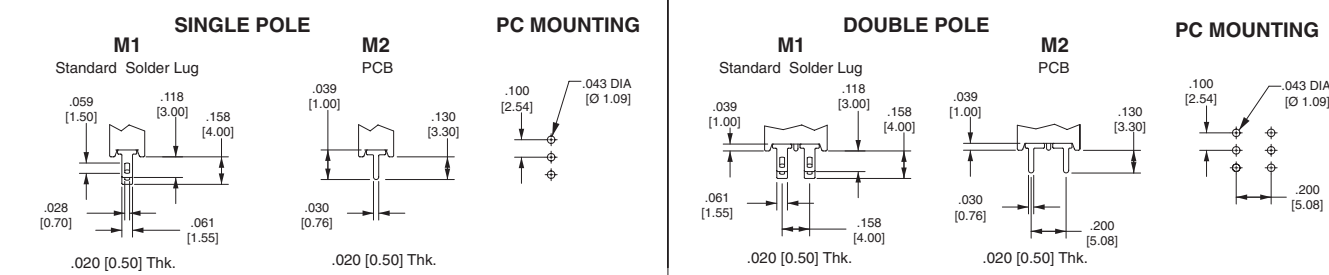

**2SS-Series**

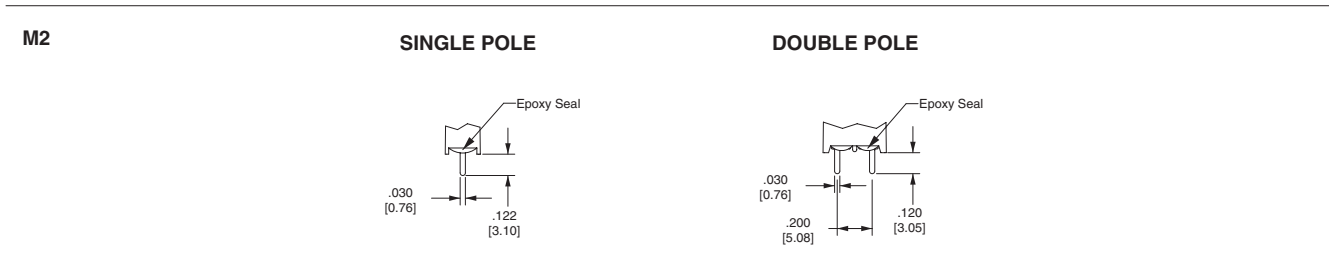

**2S-Series**

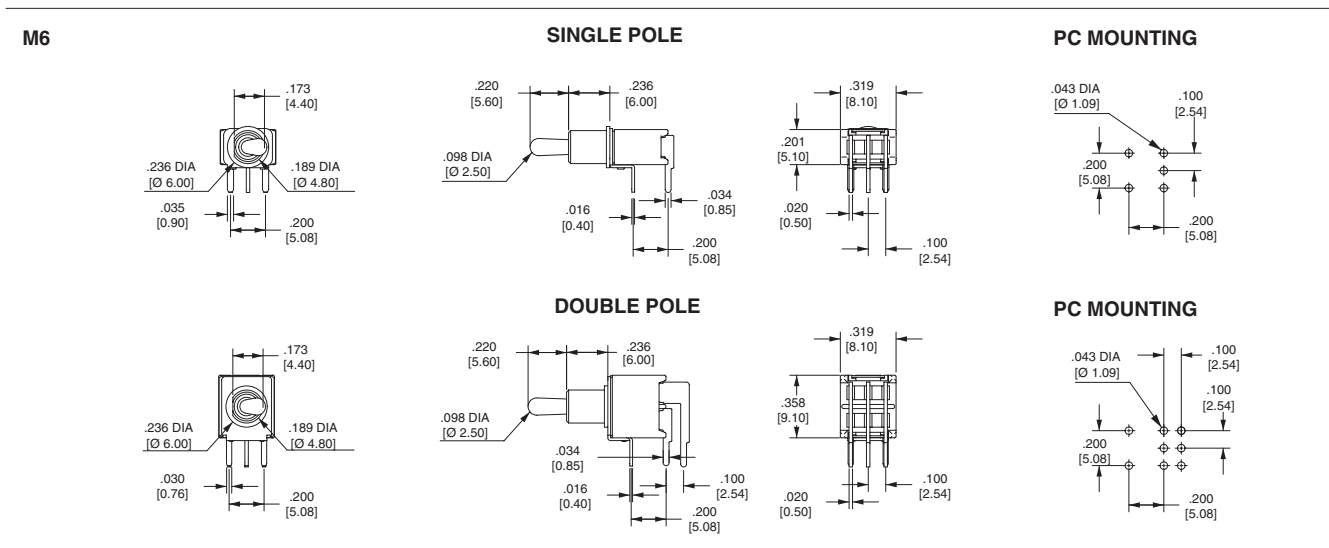

**2S-Series Dimensional Specifications: in. [mm]**

**TERMINATION**

**M7**

**SINGLE POLE**

**PC MOUNTING**

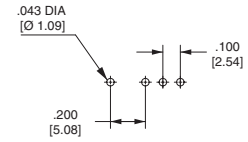
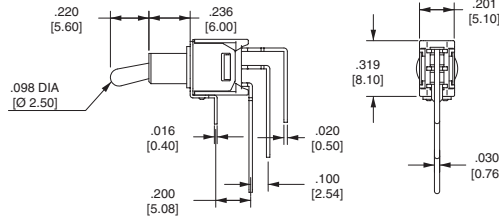
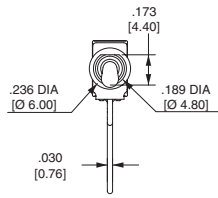

**DOUBLE POLE**

**PC MOUNTING**

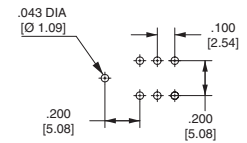
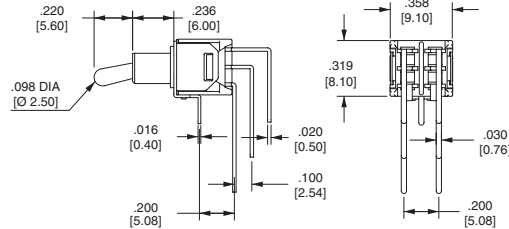
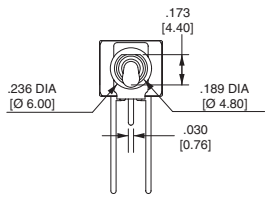

**VS2-VS3**

U Bracket Snap-in

**VS2**

**VS3**

**SINGLE POLE**

**PC MOUNTING**

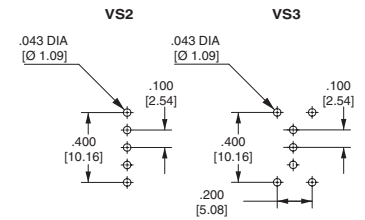
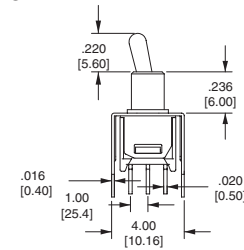
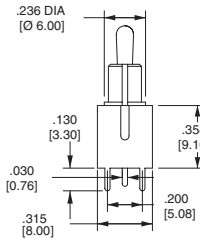
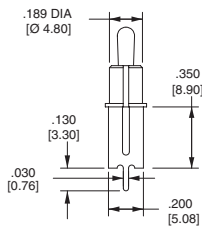

**VS2**

**VS3**

**DOUBLE POLE**

**PC MOUNTING**

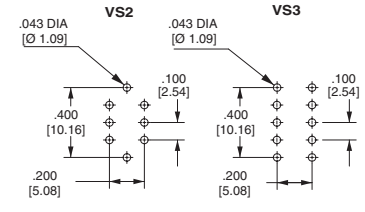
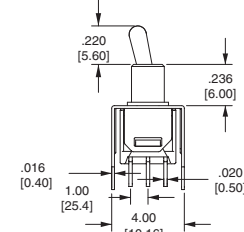
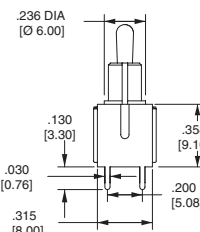
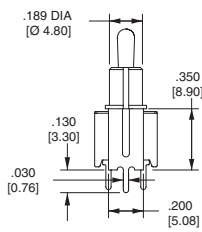

**SNAP-IN TERMINATION**

**M61**

**M71**

**VS21**

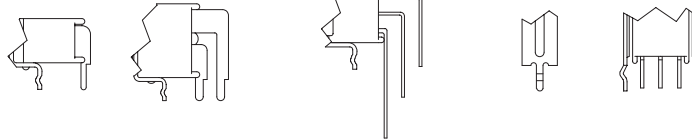

M61, M71, VS21 have the same P.C. mounting but with snap-in bracket.

**2SM-Series Dimensional Specifications: in. [mm]**

**ACTUATOR**

<p><b>T1</b> Round Bat</p> <p>For S6,M7 Only</p>	<p><b>T2</b> Round Bat</p>	<p><b>P1</b> ESD Resistant Plastic Toggle</p>	<p><b>P2</b> ESD Resistant Plastic Toggle</p>
--	--------------------------------	---	---

**TERMINATION**

**M6**  
90° Horizontal

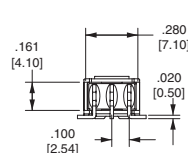
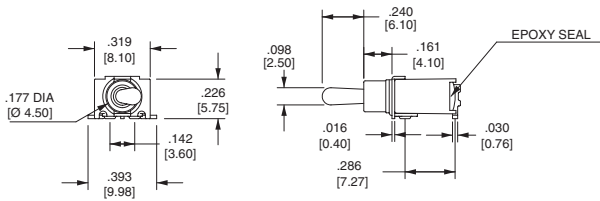

**PC MOUNTING**

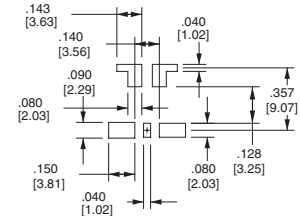

**M7**  
90° Vertical

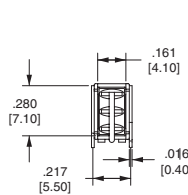
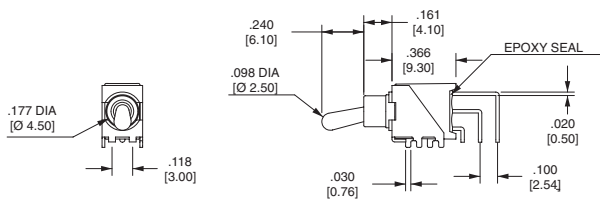

**PC MOUNTING**

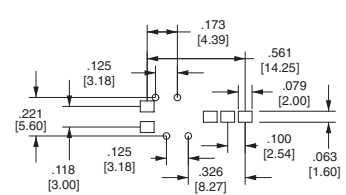

**S6**  
90° Horizontal

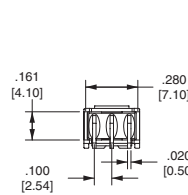
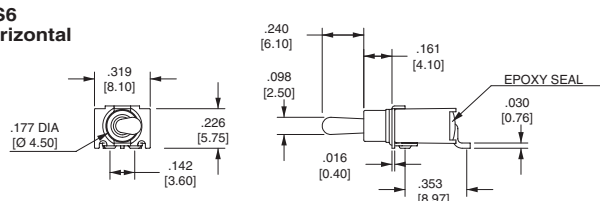

**PC MOUNTING**

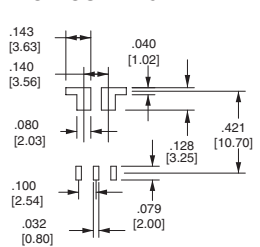

**2SM-Series Dimensional Specifications: in. [mm]**

**REEL TAPING**

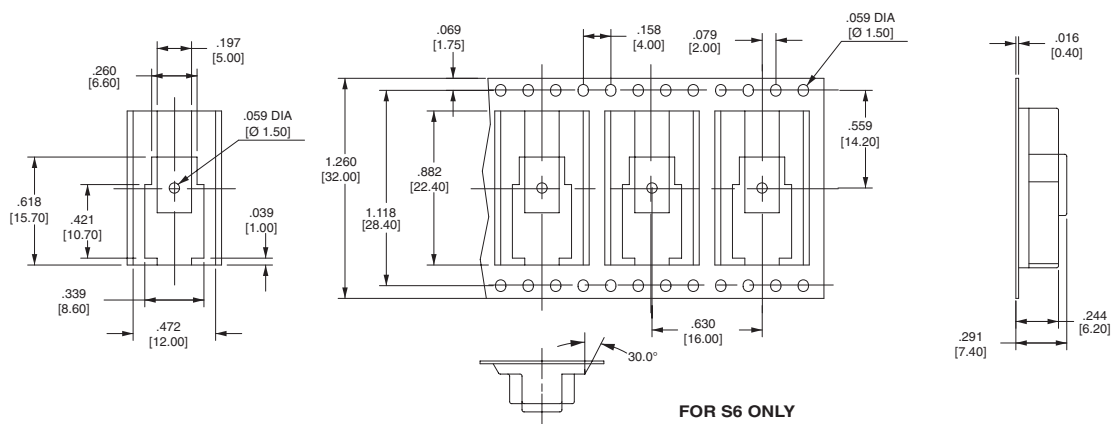
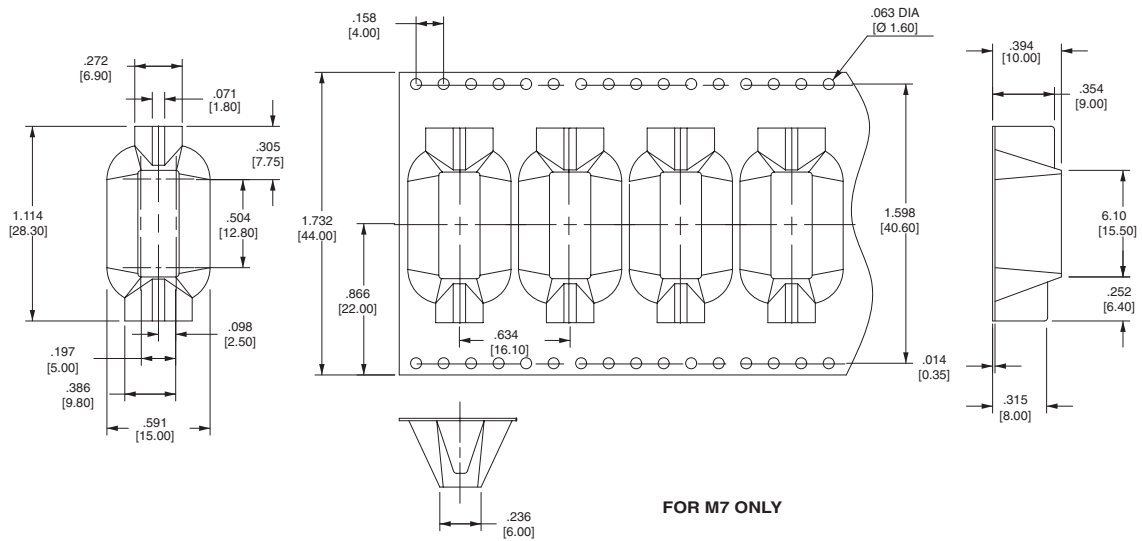
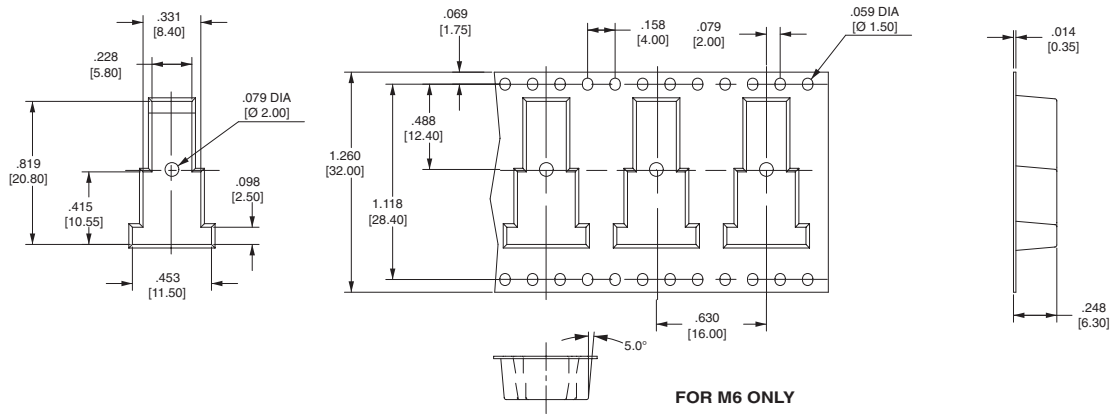

Компания «Океан Электроники» предлагает заключение долгосрочных отношений при поставках импортных электронных компонентов на взаимовыгодных условиях!

Наши преимущества:

- Поставка оригинальных импортных электронных компонентов напрямую с производств Америки, Европы и Азии, а так же с крупнейших складов мира;
- Широкая линейка поставок активных и пассивных импортных электронных компонентов (более 30 млн. наименований);
- Поставка сложных, дефицитных, либо снятых с производства позиций;
- Оперативные сроки поставки под заказ (от 5 рабочих дней);
- Экспресс доставка в любую точку России;
- Помощь Конструкторского Отдела и консультации квалифицированных инженеров;
- Техническая поддержка проекта, помощь в подборе аналогов, поставка прототипов;
- Поставка электронных компонентов под контролем ВП;
- Система менеджмента качества сертифицирована по Международному стандарту ISO 9001;
- При необходимости вся продукция военного и аэрокосмического назначения проходит испытания и сертификацию в лаборатории (по согласованию с заказчиком);
- Поставка специализированных компонентов военного и аэрокосмического уровня качества (Xilinx, Altera, Analog Devices, Intersil, Interpoint, Microsemi, Actel, Aeroflex, Peregrine, VPT, Syfer, Eurofarad, Texas Instruments, MS Kennedy, Miteq, Cobham, E2V, MA-COM, Hittite, Mini-Circuits, General Dynamics и др.);

Компания «Океан Электроники» является официальным дистрибьютором и эксклюзивным представителем в России одного из крупнейших производителей разъемов военного и аэрокосмического назначения «JONHON», а так же официальным дистрибьютором и эксклюзивным представителем в России производителя высокотехнологичных и надежных решений для передачи СВЧ сигналов «FORSTAR».



## JONHON

«JONHON» (основан в 1970 г.)

Разъемы специального, военного и аэрокосмического назначения:

(Применяются в военной, авиационной, аэрокосмической, морской, железнодорожной, горно- и нефтедобывающей отраслях промышленности)

«FORSTAR» (основан в 1998 г.)

ВЧ соединители, коаксиальные кабели,  
кабельные сборки и микроволновые компоненты:

(Применяются в телекоммуникациях гражданского и специального назначения, в средствах связи, РЛС, а так же военной, авиационной и аэрокосмической отраслях промышленности).



Телефон: 8 (812) 309-75-97 (многоканальный)

Факс: 8 (812) 320-03-32

Электронная почта: [ocean@oceanchips.ru](mailto:ocean@oceanchips.ru)

Web: <http://oceanchips.ru/>

Адрес: 198099, г. Санкт-Петербург, ул. Калинина, д. 2, корп. 4, лит. А