



## Features

- Thick film technology
- Power rating up to 1 watt @ 70 °C
- RoHS compliant\*
- Halogen free\*\*
- Sulfur-resistant design (ASTM B-809)
- AEC-Q200 compliant

## CRxxxA-AS - Sulfur-Resistant, AEC-Q200 Compliant Chip Resistors

### Electrical Characteristics

Characteristic	Model No.			
	CR0201A-AS	CR0402A-AS	CR0603A-AS	CR0805A-AS
Power Rating @ 70 °C	0.05 W	0.063 W	0.1 W	0.125 W
Operating Temp. Range	-55 to +125 °C		-55 to +155 °C	
Derated to Zero Load at	+125 °C		+155 °C	
Maximum Working Voltage (1)	25 V	50 V	50 V	150 V
Maximum Overload Voltage	50 V	100 V	100 V	300 V
Resistance Tolerance	±1 %, ±5 %			
Temperature Coefficient @ 1 % (E24 + E96)	1 Ω ~ 9.76 Ω -200 ~ +600 ppm/°C  10 Ω ~ 3M Ω +200 ppm/°C	1 Ω ~ 9.76 Ω -200 ~ +500 ppm/°C  100 Ω ≤ R ≤ 1M Ω ±100 ppm/°C  10 Ω ≤ R < 100 Ω 1M Ω < R ≤ 10M Ω ±200 ppm/°C	1 Ω ~ 9.76 Ω ±400 ppm/°C  10 Ω ≤ R ≤ 1M Ω ±100 ppm/°C  1M Ω < R ≤ 10M Ω ±200 ppm/°C	1 Ω ~ 9.76 Ω ±400 ppm/°C  10 Ω ≤ R ≤ 1M Ω ±100 ppm/°C  1M Ω < R ≤ 10M Ω ±200 ppm/°C
Temperature Coefficient @ 5 % (E24)	1 Ω ~ 9.1 Ω -200 ~ +600 ppm/°C  10 Ω ~ 10M Ω +200 ppm/°C	1 Ω ~ 9.1 Ω -200 ~ +500 ppm/°C  10 Ω ≤ R ≤ 10M Ω ±200 ppm/°C  10M Ω ≤ R ≤ 20M Ω ±400 ppm/°C	1 Ω ~ 9.1 Ω 10M < R ≤ 20M Ω ±400 ppm/°C  10 Ω ≤ R ≤ 10M Ω ±200 ppm/°C	1 Ω ~ 9.1 Ω 10M < R ≤ 20M Ω ±400 ppm/°C  10 Ω ≤ R ≤ 10M Ω ±200 ppm/°C
Zero Ohm Jumper ≤ 0.05 Ω Rated / Max. Current	0.5 A / 1 A	1 A / 2.5 A	1 A / 2.5 A	2 A / 5 A

(1) Maximum Working Voltage is calculated with formula  $V = \sqrt{P \cdot R}$  with the maximum value from the Electrical Characteristics table.

### Environmental Characteristics

Moisture Sensitivity Level..... 1  
ESD Classification (HBM)..... 1A



**WARNING Cancer and Reproductive Harm - [www.P65Warnings.ca.gov](http://www.P65Warnings.ca.gov)**

\* RoHS Directive 2002/95/EC Jan. 27, 2003 including annex and RoHS Recast 2011/65/EU June 8, 2011.

\*\* Bourns considers a product to be "halogen free" if (a) the Bromine (Br) content is 900 ppm or less; (b) the Chlorine (Cl) content is 900 ppm or less; and (c) the total Bromine (Br) and Chlorine (Cl) content is 1500 ppm or less.

Specifications are subject to change without notice.

Users should verify actual device performance in their specific applications.

The products described herein and this document are subject to specific legal disclaimers as set forth on the last page of this document, and at [www.bourns.com/docs/legal/disclaimer.pdf](http://www.bourns.com/docs/legal/disclaimer.pdf).

## Electrical Characteristics (continued)

Characteristic	Model No.			
	CR1206A-AS	CR1210A-AS	CR2010A-AS	CR2512A-AS
Power Rating @ 70 °C	0.25 W	0.33 W	0.5 W	1 W
Operating Temp. Range	-55 to +155 °C			
Derated to Zero Load at	+155 °C			
Maximum Working Voltage <sup>(1)</sup>	200 V			
Maximum Overload Voltage	400 V			
Resistance Tolerance	±1 %, ±5 %			
Temperature Coefficient @ 1 % (E24 + E96)	1 Ω ~ 9.76 Ω ±400 ppm/°C			
	10 Ω ≤ R ≤ 1M Ω ±100 ppm/°C			
	1M Ω < R ≤ 10M Ω ±200 ppm/°C			
Temperature Coefficient @ 5 % (E24)	1 Ω ~ 9.1 Ω 10M < R ≤ 20M Ω ±400 ppm/°C			
	10 Ω ≤ R ≤ 10M Ω ±200 ppm/°C			
Zero Ohm Jumper ≤ 0.05 Ω Rated / Max. Current	2 A / 5 A			

<sup>(1)</sup> Maximum Working Voltage is calculated with formula  $V = \sqrt{P \cdot R}$  with the maximum value from the Electrical Characteristics table.

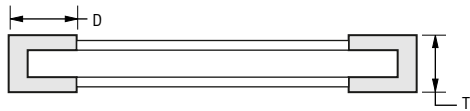
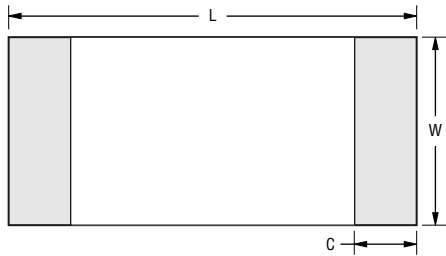
**Product Dimensions**

DIMENSIONS:  $\frac{\text{MM}}{\text{(INCHES)}}$

Model	L	W	C	D	T
CR0201A-AS	$\frac{0.60 \pm 0.03}{(.024 \pm .001)}$	$\frac{0.30 \pm 0.03}{(.012 \pm .001)}$	$\frac{0.10 \pm 0.05}{(.004 \pm .002)}$	$\frac{0.15 \pm 0.05}{(.006 \pm .002)}$	$\frac{0.23 \pm 0.03}{(.009 \pm .001)}$
CR0402A-AS	$\frac{1.00 \pm 0.10}{(.039 \pm .004)}$	$\frac{0.50 \pm 0.05}{(.020 \pm .002)}$	$\frac{0.20 \pm 0.10}{(.008 \pm .004)}$	$\frac{0.25 \pm 0.10}{(.010 \pm .004)}$	$\frac{0.32 \pm 0.05}{(.013 \pm .002)}$
CR0603A-AS	$\frac{1.60 \pm 0.10}{(.063 \pm .004)}$	$\frac{0.80 \pm 0.10}{(.031 \pm .004)}$	$\frac{0.30 \pm 0.20}{(.012 \pm .008)}$	$\frac{0.30 \pm 0.20}{(.012 \pm .008)}$	$\frac{0.45 \pm 0.10}{(.018 \pm .004)}$
CR0805A-AS	$\frac{2.00 \pm 0.10}{(.079 \pm .004)}$	$\frac{1.25 \pm 0.10}{(.049 \pm .004)}$	$\frac{0.40 \pm 0.20}{(.016 \pm .008)}$	$\frac{0.40 \pm 0.20}{(.016 \pm .008)}$	$\frac{0.50 \pm 0.10}{(.020 \pm .004)}$
CR1206A-AS	$\frac{3.10 \pm 0.10}{(.122 \pm .004)}$	$\frac{1.55 \pm 0.10}{(.061 \pm .004)}$	$\frac{0.50 \pm 0.30}{(.020 \pm .012)}$	$\frac{0.40 \pm 0.20}{(.016 \pm .008)}$	$\frac{0.55 \pm 0.10}{(.022 \pm .004)}$
CR1210A-AS	$\frac{3.10 \pm 0.10}{(.122 \pm .004)}$	$\frac{2.55 \pm 0.10}{(.100 \pm .004)}$	$\frac{0.50 \pm 0.30}{(.020 \pm .012)}$	$\frac{0.40 \pm 0.20}{(.016 \pm .008)}$	$\frac{0.60 \pm 0.10}{(.024 \pm .004)}$
CR2010A-AS	$\frac{5.00 \pm 0.15}{(.197 \pm .006)}$	$\frac{2.50 \pm 0.15}{(.098 \pm .006)}$	$\frac{0.60 \pm 0.30}{(.024 \pm .012)}$	$\frac{0.50 \pm 0.25}{(.020 \pm .010)}$	$\frac{0.60 \pm 0.10}{(.024 \pm .004)}$
CR2512A-AS	$\frac{6.30 \pm 0.20}{(.248 \pm .008)}$	$\frac{3.20 \pm 0.20}{(.126 \pm .008)}$	$\frac{0.60 \pm 0.30}{(.024 \pm .012)}$	$\frac{0.50 \pm 0.25}{(.020 \pm .010)}$	$\frac{0.60 \pm 0.10}{(.024 \pm .004)}$

Specifications are subject to change without notice.

Users should verify actual device performance in their specific applications.

The products described herein and this document are subject to specific legal disclaimers as set forth on the last page of this document, and at [www.bourns.com/docs/legal/disclaimer.pdf](http://www.bourns.com/docs/legal/disclaimer.pdf).

# CRxxxxA-AS - Sulfur-Resistant, AEC-Q200 Compliant Chip Resistors



## Recommended Pad Layout

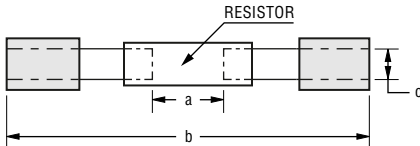

DIMENSIONS:  $\frac{\text{MM}}{\text{(INCHES)}}$

Model	a	b	c
CR0201A-AS	$\frac{0.25 \sim 0.30}{(.010 \sim .012)}$	$\frac{0.70 \sim 0.90}{(.028 \sim .035)}$	$\frac{0.30 \sim 0.40}{(.012 \sim .016)}$
CR0402A-AS	$\frac{0.50 \sim 0.60}{(.020 \sim .024)}$	$\frac{1.40 \sim 1.60}{(.055 \sim .063)}$	$\frac{0.40 \sim 0.60}{(.012 \sim .024)}$
CR0603A-AS	$\frac{0.70 \sim 0.90}{(.028 \sim .035)}$	$\frac{2.00 \sim 2.20}{(.079 \sim .087)}$	$\frac{0.80 \sim 1.00}{(.031 \sim .039)}$
CR0805A-AS	$\frac{1.00 \sim 1.40}{(.039 \sim .055)}$	$\frac{3.20 \sim 3.80}{(.126 \sim .150)}$	$\frac{0.90 \sim 1.40}{(.035 \sim .055)}$
CR1206A-AS	$\frac{2.00 \sim 2.40}{(.079 \sim .094)}$	$\frac{4.40 \sim 5.00}{(.173 \sim .197)}$	$\frac{1.20 \sim 1.80}{(.047 \sim .071)}$
CR1210A-AS	$\frac{2.00 \sim 2.40}{(.079 \sim .094)}$	$\frac{4.50 \sim 5.00}{(.177 \sim .197)}$	$\frac{2.30 \sim 3.50}{(.091 \sim .138)}$
CR2010A-AS	$\frac{3.30 \sim 3.70}{(.130 \sim .146)}$	$\frac{5.70 \sim 6.50}{(.224 \pm .256)}$	$\frac{2.30 \sim 3.50}{(.091 \sim .138)}$
CR2512A-AS	$\frac{3.60 \sim 4.00}{(.142 \sim .157)}$	$\frac{7.60 \sim 8.60}{(.299 \sim .339)}$	$\frac{2.30 \sim 3.50}{(.091 \sim .138)}$

## Soldering Profile

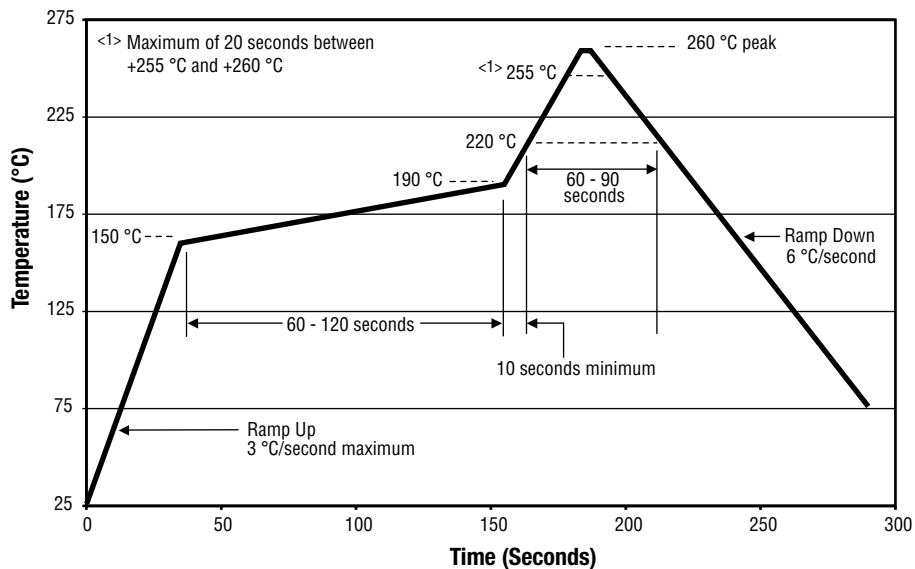

Specifications are subject to change without notice.

Users should verify actual device performance in their specific applications.

The products described herein and this document are subject to specific legal disclaimers as set forth on the last page of this document, and at [www.bourns.com/docs/legal/disclaimer.pdf](http://www.bourns.com/docs/legal/disclaimer.pdf).

## Performance Characteristics (AEC-Q200)

Test	Method	Procedure	Test Limits $\Delta R$
Short Time Overload	IEC 60115-1 4.13	2.5 X rated voltage for 5 sec.	$\pm (1 \% + 0.05 \Omega)$ Remarks: 0201: $\pm (3 \% + 0.1 \Omega)$ 0402: $\pm (2 \% + 0.1 \Omega)$ 0 $\Omega$ : 50 m $\Omega$ or less
High Temperature Exposure (Storage)	AEC-Q200-REV D-Test 3 MIL-STD-202 Method 108	1000 hrs. @ T=155 °C. Unpowered. Measurement at 24 $\pm$ 2 hours after test conclusion.	1 %: $\pm (1.0 \% + 0.05 \Omega)$ 5 %: $\pm (2.0 \% + 0.1 \Omega)$ 0201: $\pm (3 \% + 0.1 \Omega)$ 0 $\Omega$ : 50 m $\Omega$ or less
Temperature Cycling	AEC-Q200-REV D-Test 4 JESD22 Method JA-104	1000 cycles (-55 °C to +125 °C) Measurement at 24 $\pm$ 4 hours after test conclusion. 30 min. maximum dwell time at each temperature extreme. 1 min. maximum transition time.	$\pm (1.0 \% + 0.1 \Omega)$ 0201: $\pm (2 \% + 0.1 \Omega)$ 0 $\Omega$ : 50 m $\Omega$ or less
Moisture Resistance	AEC-Q200-REV D-Test 6 MIL-STD-202 Method 106	T=24 hours / Cycle, 10 Cycles. Notes: Steps 7a & 7b not required. Unpowered.	1 %: $\pm (1.0 \% + 0.05 \Omega)$ 2 %, 5 %: $\pm (2.0 \% + 0.1 \Omega)$ 0201: $\pm (3 \% + 0.1 \Omega)$ 0 $\Omega$ : 50 m $\Omega$ or less
Biased Humidity	AEC-Q200-REV D-Test 7 MIL-STD-202 Method 103	1000 hours 85 °C / 85 % RH. Note: Specified conditions: 10 % of operating power (not exceeding max. working voltage). Measurement at 24 $\pm$ 2 hours after test conclusion.	$\pm (3 \% + 0.1 \Omega)$ 0201: $\pm (5 \% + 0.1 \Omega)$ 0 $\Omega$ : 100 m $\Omega$ or less
Operational Life	AEC-Q200-REV D-Test 8 MIL-STD-202 Method 108	1000 hours T <sub>A</sub> =125 °C at 35 % rated power. Measurement at 24 $\pm$ 4 hours after test conclusion.	1 %: $\pm (1 \% + 0.1 \Omega)$ 5 %: $\pm (3 \% + 0.1 \Omega)$ 0201: $\pm (5 \% + 0.1 \Omega)$ 0 $\Omega$ : 100 m $\Omega$ or less
External Visual	AEC-Q200-REV D-Test 9 MIL-STD-883 Method 2009	Electrical test not required. Inspect device construction, marking and workmanship.	
Physical Dimension	AEC-Q200-REV D-Test 10 JESD22 Method JB-100	Verify physical dimensions to the applicable device detail spec. Note: User(s) and Suppliers spec. Electrical test not required.	
Resistance to Solvents	AEC-Q200-REV D-Test 12 MIL-STD-202 Method 215	a: Isopropyl Alcohol : Mineral Spirits = 1:3 b: Terpene Defluxer (Bioact EC-7R) c: Deionized water : Propylene Glycol Monomethyl Ether : monoethanolamine = 42:1:1	Marking and protective layer cannot be detached
Mechanical Shock	AEC-Q200-REV D-Test 13 MIL-STD-202 Method 213	Wave Form: Tolerance for half sine shock pulse. Peak value is 100 grams. Normal duration (D) is 6 ms.	$\pm (1 \% + 0.1 \Omega)$ 0 $\Omega$ : 50 m $\Omega$ or less
Vibration	AEC-Q200-REV D-Test 14 MIL-STD-202 Method 204	5 grams for 20 min., 12 cycles each of 3 orientations. Note: Test from 10-2000 Hz.	$\pm (1 \% + 0.1 \Omega)$ 0 $\Omega$ : 50 m $\Omega$ or less
Resistance to Soldering Heat	AEC-Q200-REV D-Test 15 MIL-STD-202 Method 210	Condition B: Immerse the specimens in and eutectic solder at 260 $\pm$ 5 °C for 10 $\pm$ 1 S.	1 %: $\pm (0.5 \% + 0.05 \Omega)$ 5 %: $\pm (1 \% + 0.1 \Omega)$ 0201: $\pm (2 \% + 0.1 \Omega)$ 0 $\Omega$ : 50 m $\Omega$ or less
Thermal Shock	AEC-Q200-REV D-Test 16 MIL-STD-202 Method 107	-55 °C / +155 °C. Note: Number of cycles required: 1000, Maximum transfer time: 20 seconds, Dwell time: 15 minutes. Air to Air.	$\pm (1 \% + 0.1 \Omega)$ 0201: $\pm (2 \% + 0.1 \Omega)$ 0 $\Omega$ : 50 m $\Omega$ or less
ESD	AEC-Q200-REV D-Test 17	Verify the voltage setting at 500 V	$\pm (1 \% + 0.1 \Omega)$ 0201: $\pm (2 \% + 0.1 \Omega)$
Solderability	AEC-Q200-REV D-Test 18 J-STD-002	Method B, aging 4 hours at 155 °C dry heat Lead-free solder bath at 235 $\pm$ 3 °C Dipping time: 3 $\pm$ 0.5 seconds	> 95 % area covered with tin
Flammability	AEC-Q200-REV D-Test 17 UL-94	V-0 or V-1 are acceptable. Electrical test not required.	V-0 or V-1
Board Flex (Bending)	AEC-Q200-REV D-Test 21	The duration of the applied forces shall be 60 ( $\pm$ 5) seconds. 3 mm deflection (0201~1210) 2 mm deflection (2010~2512)	1 %: $\pm (0.5 \% + 0.05 \Omega)$ 5 %: $\pm (1 \% + 0.1 \Omega)$ 0201: $\pm (1 \% + 0.1 \Omega)$ 0 $\Omega$ : 50 m $\Omega$ or less
Terminal Strength (SMD)	IEC 60115-1 4.32	Force of 1.8 kg for 60 seconds. Note: 0201= N/A	$\pm (0.5 \% + 0.05 \Omega)$ 0 $\Omega$ : 50 m $\Omega$ or less
Sulfuration Test	ASTM-B-809-95	Sulfur (saturated vapor) 1,000 hours, 105 $\pm$ 2 °C, unpowered	1 %: $\pm (1 \% + 0.05 \Omega)$ 5 %: $\pm (2 \% + 0.05 \Omega)$ 0201: 1 %: $\pm (2 \% + 0.05 \Omega)$ 5 %: $\pm (3 \% + 0.05 \Omega)$ 0 $\Omega$ : 100 m $\Omega$ or less

Specifications are subject to change without notice. Users should verify actual device performance in their specific applications.

The products described herein and this document are subject to specific legal disclaimers as set forth on the last page of this document, and at [www.bourns.com/docs/legal/disclaimer.pdf](http://www.bourns.com/docs/legal/disclaimer.pdf).

# CRxxxxA-AS - Sulfur-Resistant, AEC-Q200 Compliant Chip Resistors



## Derating Curve

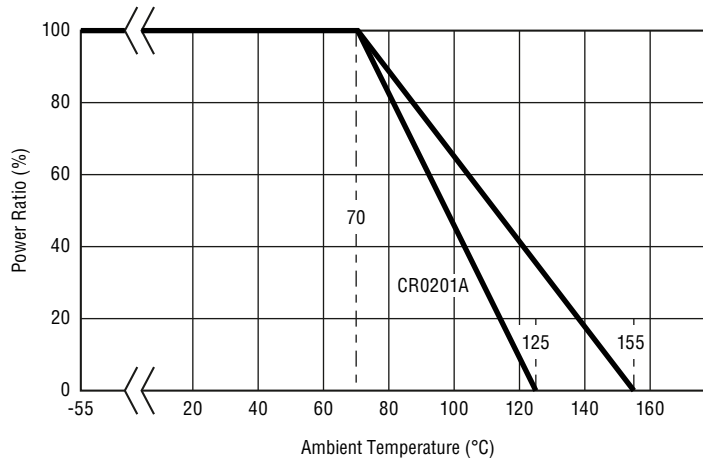

## Packaging Dimensions (Conforms to EIA RS-481A)

Model	Tape Type	A	B	W	F	E	P1	P2	P0	T
CR0201A-AS	Paper Tape (2 mm pitch)	$\frac{0.37 \pm 0.05}{(.010 \pm .002)}$	$\frac{0.67 \pm 0.10}{(.026 \pm .004)}$				$\frac{2.00 \pm 0.10}{(.079 \pm .004)}$	$\frac{2.00 \pm 0.05}{(.079 \pm .002)}$		$\frac{0.37 \pm 0.10}{(.015 \pm .004)}$
CR0402A-AS		$\frac{0.70 \pm 0.05}{(.028 \pm .002)}$	$\frac{1.20 \pm 0.05}{(.047 \pm .002)}$				$\frac{2.00 \pm 0.10}{(.079 \pm .004)}$	$\frac{0.45 \pm 0.10}{(.018 \pm .004)}$		
CR0603A-AS	Paper Tape (4 mm pitch)	$\frac{1.10 \pm 0.10}{(.043 \pm .004)}$	$\frac{1.90 \pm 0.10}{(.075 \pm .004)}$	$\frac{8.00 \pm 0.20}{(.315 \pm .008)}$	$\frac{3.50 \pm 0.05}{(.138 \pm .002)}$	$\frac{1.75 \pm 0.10}{(.069 \pm .004)}$	$\frac{4.00 \pm 0.10}{(.157 \pm .004)}$	$\frac{2.00 \pm 0.05}{(.079 \pm .002)}$	$\frac{4.00 \pm 0.10}{(.157 \pm .004)}$	$\frac{0.64 \pm 0.10}{(.025 \pm .004)}$
CR0805A-AS		$\frac{1.65 \pm 0.15}{(.065 \pm .006)}$	$\frac{2.40 \pm 0.20}{(.094 \pm .008)}$							$\frac{0.84 \pm 0.10}{(.033 \pm .004)}$
CR1206A-AS		$\frac{2.00 \pm 0.15}{(.079 \pm .006)}$	$\frac{3.60 \pm 0.20}{(.142 \pm .008)}$							$\frac{0.84 \pm 0.10}{(.033 \pm .004)}$
CR1210A-AS		$\frac{2.80 \pm 0.20}{(.110 \pm .008)}$	$\frac{3.60 \pm 0.20}{(.142 \pm .008)}$							$\frac{0.84 \pm 0.10}{(.033 \pm .004)}$
CR2010A-AS		Embossed Tape (4 mm pitch)	$\frac{2.80 \pm 0.20}{(.110 \pm .008)}$							$\frac{5.30 \pm 0.20}{(.209 \pm .008)}$
CR2512A-AS	$\frac{3.60 \pm 0.20}{(.142 \pm .008)}$		$\frac{6.90 \pm 0.20}{(.272 \pm .008)}$	$\frac{0.85 \pm 0.15}{(.033 \pm .006)}$						

DIMENSIONS:  $\frac{\text{MM}}{\text{(INCHES)}}$

# CRxxxxA-AS - Sulfur-Resistant, AEC-Q200 Compliant Chip Resistors



## Packaging Dimensions (Conforms to EIA RS-481A)

PAPER TAPE (2 mm PITCH)

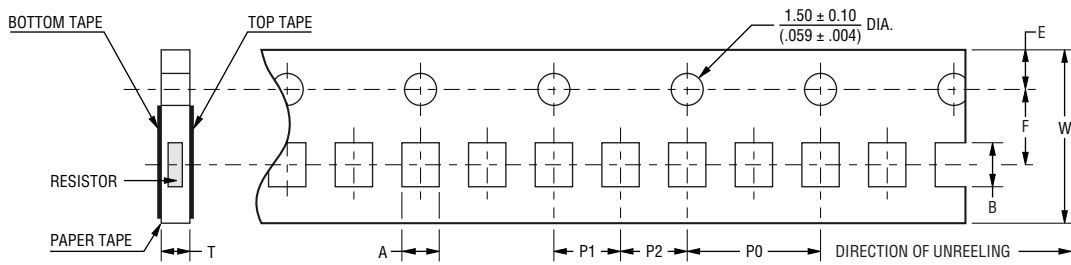

PAPER TAPE (4 mm PITCH)

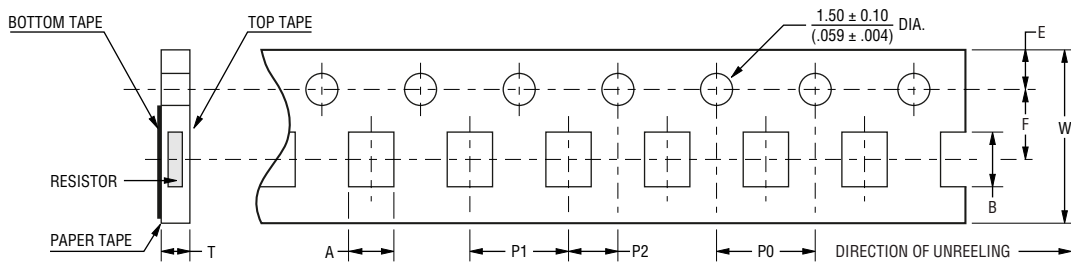

EMBOSSED TAPE (4 mm PITCH)

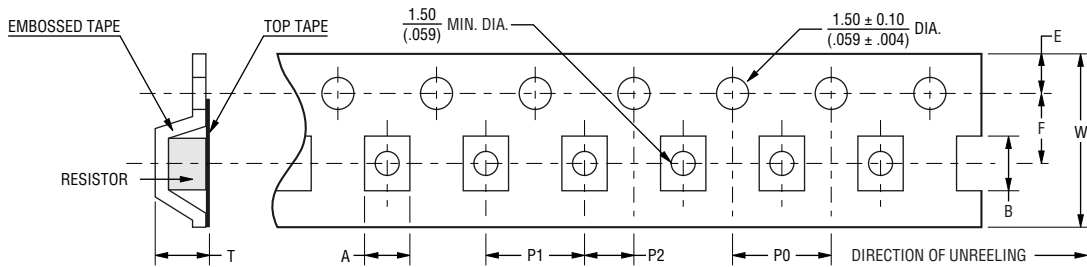

DIMENSIONS:  $\frac{\text{MM}}{\text{(INCHES)}}$

Specifications are subject to change without notice.

Users should verify actual device performance in their specific applications.

The products described herein and this document are subject to specific legal disclaimers as set forth on the last page of this document, and at [www.bourns.com/docs/legal/disclaimer.pdf](http://www.bourns.com/docs/legal/disclaimer.pdf).

**CRxxxxA-AS - Sulfur-Resistant, AEC-Q200 Compliant Chip Resistors**



**Packaging Dimensions (Conforms to EIA RS-481A)**

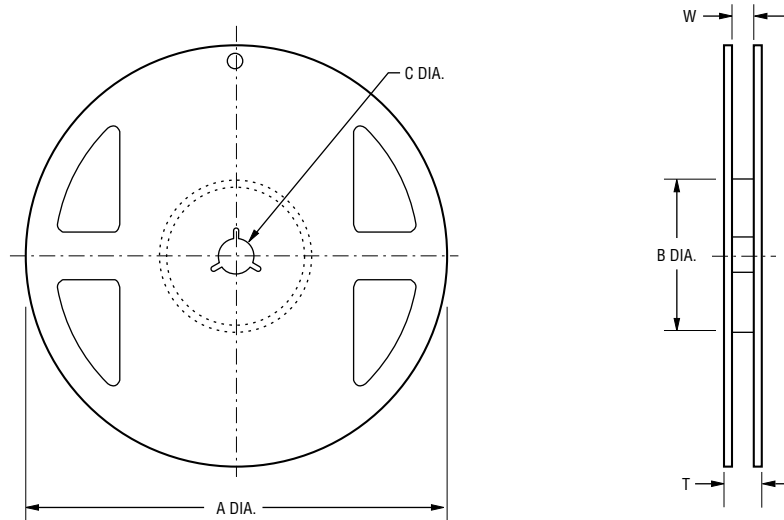

Model	Packaging Quantity	A	B	C	W	T
CR0201A-AS	10K pcs/reel					
CR0402A-AS						
CR0603A-AS	5K pcs/reel	$\frac{178 \pm 2.0}{(7.008 \pm .079)}$	$\frac{60 \pm 1.0}{(2.362 \pm .039)}$	$\frac{13.0 \pm 1.0}{(.512 \pm .039)}$	$\frac{9.0 \pm 1.0}{(.354 \pm .039)}$	$\frac{11.5 \pm 1.0}{(.453 \pm .039)}$
CR0805A-AS						
CR1206A-AS						
CR1210A-AS						
CR2010A-AS	4K pcs/reel	$\frac{178 \pm 2.0}{(7.008 \pm .079)}$	$\frac{60 \pm 0.5}{(2.362 \pm .020)}$	$\frac{13.0 \pm 0.5}{(.512 \pm .020)}$	$\frac{13.0 \pm 1.0}{(.512 \pm .039)}$	$\frac{15.5 \pm 1.0}{(.610 \pm .039)}$
CR2512A-AS						

DIMENSIONS:  $\frac{\text{MM}}{\text{(INCHES)}}$

Specifications are subject to change without notice.  
 Users should verify actual device performance in their specific applications.  
 The products described herein and this document are subject to specific legal disclaimers as set forth on the last page of this document, and at [www.bourns.com/docs/legal/disclaimer.pdf](http://www.bourns.com/docs/legal/disclaimer.pdf).



**How to Order**

CR 0603 A F X - 1002 E AS

**Model**

(CR = Fixed Resistor)

**Size**

- 0201 = 0201 size
- 0402 = 0402 size
- 0603 = 0603 size
- 0805 = 0805 size
- 1206 = 1206 size
- 1210 = 1210 size
- 2010 = 2010 size
- 2510 = 2510 size

**Feature**

A = AEC-Q200 Compliant

**Resistance Tolerance**

- F = ±1 %
- J = ±5 %

**TCR (ppm/°C)** – See Electrical Characteristics Chart

- X = ±100
- W = ±200
- Z = ±400
- / = Used for zero Ω (jumper) and values from 1 Ω through 9.76 Ω.

**Resistance Value**

For 1 % Tolerance:

<100 Ω..... "R" represents decimal point (example: 24R3 = 24.3 Ω).

>100 Ω ..... First three digits are significant, fourth digit represents number of zeros to follow (example: 8252 = 82.5K Ω).

For 5 % Tolerance:

<10 Ω..... "R" represents decimal point (example: 4R7 = 4.7 Ω).

>10 Ω..... First two digits are significant, third digit represents number of zeros to follow (example: 474 = 470K Ω).

**Packaging**

- G = Paper Tape (10,000 pcs.) on 7 " Reel – CR0201A-AS, CR0402A-AS
- E = Paper Tape (5,000 pcs.) on 7 " Reel – CR0603A-AS, CR0805A-AS, CR1206A-AS, CR1210A-AS
- E = Embossed Tape (4,000 pcs) on 7 " Reel – CR2010A-AS, CR2512A-AS

**Termination**

AS = Anti-sulfur version, Tin-plated (RoHS Compliant)

## Symbol for E96 Series Nominal Resistance Value

Symbol	E96	Symbol	E96	Symbol	E96	Symbol	E96
01	100	25	178	49	316	73	562
02	102	26	182	50	324	74	576
03	105	27	187	51	332	75	590
04	107	28	191	52	340	76	604
05	110	29	196	53	348	77	619
06	113	30	200	54	357	78	634
07	115	31	205	55	365	79	649
08	118	32	210	56	374	80	665
09	121	33	215	57	383	81	681
10	124	34	221	58	392	82	698
11	127	35	226	59	402	83	715
12	130	36	232	60	412	84	732
13	133	37	237	61	422	85	750
14	137	38	243	62	432	86	768
15	140	39	249	63	442	87	787
16	143	40	255	64	453	88	806
17	147	41	261	65	464	89	825
18	150	42	267	66	475	90	845
19	154	43	274	67	487	91	866
20	158	44	280	68	499	92	887
21	162	45	287	69	511	93	909
22	165	46	294	70	523	94	931
23	169	47	301	71	536	95	953
24	174	48	309	72	549	96	976

## Symbol for Multipliers

Symbol	A	B	C	D	E	F	G	H	X	Y	Z
Multiplier	10 <sup>0</sup>	10 <sup>1</sup>	10 <sup>2</sup>	10 <sup>3</sup>	10 <sup>4</sup>	10 <sup>5</sup>	10 <sup>6</sup>	10 <sup>7</sup>	10 <sup>-1</sup>	10 <sup>-2</sup>	10 <sup>-3</sup>

## Marking Explanation



**±5 % (E24): CR0603-A-AS / CR0805A-AS / CR1206A-AS / CR1210A-AS / CR2010A-AS / CR2512A-AS**

Resistance value is expressed by 3 digits. The first two digits represent the significant figures of nominal resistance value in  $\Omega$ . And the third digit represents exponent for base of 10.

EX: 102 =  $10 \times 10^2 = 1000 \Omega = 1K \Omega$

**±1 % (E96): CR0805A-AS / CR1206A-AS / CR1210A-AS / CR2010A-AS / CR2512A-AS**

Resistance value is expressed by 3 digits. The first two digits represent the significant figures of nominal resistance value in  $\Omega$ . And the third digit represents exponent for base of 10.

EX: 102 =  $10 \times 10^2 = 1000 \Omega = 1K \Omega$



**±1 % (E96): CR0603A-AS**

When the marking space is too small in such small-sized resistors as CR0603A-AS, the marking cannot be made by 4 digits and may be made by two digits combined with one English capital.

EX: 01A =  $100 \times 10^0 = 100 \Omega$

# **BOURNS**<sup>®</sup>

**Asia-Pacific:** Tel: +886-2 2562-4117 • Email: asiacus@bourns.com

**EMEA:** Tel: +36 88 885 877 • Email: eurocus@bourns.com

**The Americas:** Tel: +1-951 781-5500 • Email: americus@bourns.com

[www.bourns.com](http://www.bourns.com)

05/19

Specifications are subject to change without notice.

Users should verify actual device performance in their specific applications.

The products described herein and this document are subject to specific legal disclaimers as set forth on the last page of this document, and at [www.bourns.com/docs/legal/disclaimer.pdf](http://www.bourns.com/docs/legal/disclaimer.pdf).

This legal disclaimer applies to purchasers and users of Bourns® products manufactured by or on behalf of Bourns, Inc. and its affiliates (collectively, "Bourns").

Unless otherwise expressly indicated in writing, Bourns® products and data sheets relating thereto are subject to change without notice. Users should check for and obtain the latest relevant information and verify that such information is current and complete before placing orders for Bourns® products.

The characteristics and parameters of a Bourns® product set forth in its data sheet are based on laboratory conditions, and statements regarding the suitability of products for certain types of applications are based on Bourns' knowledge of typical requirements in generic applications. The characteristics and parameters of a Bourns® product in a user application may vary from the data sheet characteristics and parameters due to (i) the combination of the Bourns® product with other components in the user's application, or (ii) the environment of the user application itself. The characteristics and parameters of a Bourns® product also can and do vary in different applications and actual performance may vary over time. Users should always verify the actual performance of the Bourns® product in their specific devices and applications, and make their own independent judgments regarding the amount of additional test margin to design into their device or application to compensate for differences between laboratory and real world conditions.

Unless Bourns has explicitly designated an individual Bourns® product as meeting the requirements of a particular industry standard (e.g., ISO/TS 16949) or a particular qualification (e.g., UL listed or recognized), Bourns is not responsible for any failure of an individual Bourns® product to meet the requirements of such industry standard or particular qualification. Users of Bourns® products are responsible for ensuring compliance with safety-related requirements and standards applicable to their devices or applications.

Bourns® products are not recommended, authorized or intended for use in nuclear, lifesaving, life-critical or life-sustaining applications, nor in any other applications where failure or malfunction may result in personal injury, death, or severe property or environmental damage. Unless expressly and specifically approved in writing by two authorized Bourns representatives on a case-by-case basis, use of any Bourns® products in such unauthorized applications might not be safe and thus is at the user's sole risk. Life-critical applications include devices identified by the U.S. Food and Drug Administration as Class III devices and generally equivalent classifications outside of the United States.

Bourns expressly identifies those Bourns® standard products that are suitable for use in automotive applications on such products' data sheets in the section entitled "Applications." Unless expressly and specifically approved in writing by two authorized Bourns representatives on a case-by-case basis, use of any other Bourns® standard products in an automotive application might not be safe and thus is not recommended, authorized or intended and is at the user's sole risk. If Bourns expressly identifies a sub-category of automotive application in the data sheet for its standard products (such as infotainment or lighting), such identification means that Bourns has reviewed its standard product and has determined that if such Bourns® standard product is considered for potential use in automotive applications, it should only be used in such sub-category of automotive applications. Any reference to Bourns® standard product in the data sheet as compliant with the AEC-Q standard or "automotive grade" does not by itself mean that Bourns has approved such product for use in an automotive application.

Bourns® standard products are not tested to comply with United States Federal Aviation Administration standards generally or any other generally equivalent governmental organization standard applicable to products designed or manufactured for use in aircraft or space applications. Bourns expressly identifies Bourns® standard products that are suitable for use in aircraft or space applications on such products' data sheets in the section entitled "Applications." Unless expressly and specifically approved in writing by two authorized Bourns representatives on a case-by-case basis, use of any other Bourns® standard product in an aircraft or space application might not be safe and thus is not recommended, authorized or intended and is at the user's sole risk.

The use and level of testing applicable to Bourns® custom products shall be negotiated on a case-by-case basis by Bourns and the user for which such Bourns® custom products are specially designed. Absent a written agreement between Bourns and the user regarding the use and level of such testing, the above provisions applicable to Bourns® standard products shall also apply to such Bourns® custom products.

Users shall not sell, transfer, export or re-export any Bourns® products or technology for use in activities which involve the design, development, production, use or stockpiling of nuclear, chemical or biological weapons or missiles, nor shall they use Bourns® products or technology in any facility which engages in activities relating to such devices. The foregoing restrictions apply to all uses and applications that violate national or international prohibitions, including embargos or international regulations. Further, Bourns® products and Bourns technology and technical data may not under any circumstance be exported or re-exported to countries subject to international sanctions or embargoes. Bourns® products may not, without prior authorization from Bourns and/or the U.S. Government, be resold, transferred, or re-exported to any party not eligible to receive U.S. commodities, software, and technical data.

To the maximum extent permitted by applicable law, Bourns disclaims (i) any and all liability for special, punitive, consequential, incidental or indirect damages or lost revenues or lost profits, and (ii) any and all implied warranties, including implied warranties of fitness for particular purpose, non-infringement and merchantability.

*For your convenience, copies of this Legal Disclaimer Notice with German, Spanish, Japanese, Traditional Chinese and Simplified Chinese bilingual versions are available at:*

*Web Page:* <http://www.bourns.com/legal/disclaimers-terms-and-policies>

*PDF:* <http://www.bourns.com/docs/Legal/disclaimer.pdf>

Компания «Океан Электроники» предлагает заключение долгосрочных отношений при поставках импортных электронных компонентов на взаимовыгодных условиях!

Наши преимущества:

- Поставка оригинальных импортных электронных компонентов напрямую с производств Америки, Европы и Азии, а так же с крупнейших складов мира;
- Широкая линейка поставок активных и пассивных импортных электронных компонентов (более 30 млн. наименований);
- Поставка сложных, дефицитных, либо снятых с производства позиций;
- Оперативные сроки поставки под заказ (от 5 рабочих дней);
- Экспресс доставка в любую точку России;
- Помощь Конструкторского Отдела и консультации квалифицированных инженеров;
- Техническая поддержка проекта, помощь в подборе аналогов, поставка прототипов;
- Поставка электронных компонентов под контролем ВП;
- Система менеджмента качества сертифицирована по Международному стандарту ISO 9001;
- При необходимости вся продукция военного и аэрокосмического назначения проходит испытания и сертификацию в лаборатории (по согласованию с заказчиком);
- Поставка специализированных компонентов военного и аэрокосмического уровня качества (Xilinx, Altera, Analog Devices, Intersil, Interpoint, Microsemi, Actel, Aeroflex, Peregrine, VPT, Syfer, Eurofarad, Texas Instruments, MS Kennedy, Miteq, Cobham, E2V, MA-COM, Hittite, Mini-Circuits, General Dynamics и др.);

Компания «Океан Электроники» является официальным дистрибьютором и эксклюзивным представителем в России одного из крупнейших производителей разъемов военного и аэрокосмического назначения «JONHON», а так же официальным дистрибьютором и эксклюзивным представителем в России производителя высокотехнологичных и надежных решений для передачи СВЧ сигналов «FORSTAR».



## JONHON

«JONHON» (основан в 1970 г.)

Разъемы специального, военного и аэрокосмического назначения:

(Применяются в военной, авиационной, аэрокосмической, морской, железнодорожной, горно- и нефтедобывающей отраслях промышленности)

«FORSTAR» (основан в 1998 г.)

ВЧ соединители, коаксиальные кабели, кабельные сборки и микроволновые компоненты:

(Применяются в телекоммуникациях гражданского и специального назначения, в средствах связи, РЛС, а так же военной, авиационной и аэрокосмической отраслях промышленности).



Телефон: 8 (812) 309-75-97 (многоканальный)

Факс: 8 (812) 320-03-32

Электронная почта: [ocean@oceanchips.ru](mailto:ocean@oceanchips.ru)

Web: <http://oceanchips.ru/>

Адрес: 198099, г. Санкт-Петербург, ул. Калинина, д. 2, корп. 4, лит. А