

RTE Series Low Profile Rotary DIP Switches

ROHS COMPLIANT

H

DIP

Features/Benefits

- Thru-hole and surface mount models
- Miniature size with robust metal cover in black or silver nickel finish
- 4, 10, & 16 positions
- Large choice of codings
- Vertical, right angle or reverse versions
- RoHS compliant

Typical Applications

- Timers, automation components
- Computer and peripherals
- Alarms, access control, smoke detectors, lighting, home protection
- Instrumentation



Specifications

CONTACT RATING:

Gold: 100 mA max. 10 μ A min. 30 V DC max. 20 mVDC min.

MECHANICAL LIFE: 20,000 indexations

CONTACT RESISTANCE: 100 m Ω max. initial;
150 m Ω after life

INSULATION RESISTANCE: 10¹⁰ Ω min. initial

DIELECTRIC STRENGTH: 300 Vrms 1 mn

OPERATING TEMPERATURE: -25°C to 85°C.

STORAGE TEMPERATURE: -55°C to 85°C.

PACKAGING:

Quantities

Terminations	Actuator	Tube	Box (in bulk)	Carrier tape	Standard Package
G	Flush, screwdriver slot			1250	1250 (1 reel)
	Shaft for button			750	750 (1 reel)
N	All versions	65			1950 (30 tubes)
V	All versions		150		1500 (10 boxes)
R	Flush, screwdriver slot	65			1950 (30 tubes)
	Shaft for button		150		1500 (10 boxes)

Materials

COVER: Brass, nickel plated (black or silver)

BASE: PPS

ACTUATOR: LCP

MOVABLE CONTACTS: Copper alloy, gold plated.

STATIONARY CONTACTS: Brass, gold plated.

TERMINALS: See page I-28 to I-29

O-RING: Silicone

SOLDERING PROCESS:

- Surface Mount Terminals: Infrared Reflow Soldering in accordance with IEC 61760-1.

- Non Reverse Thru-Hole Terminals: Lead free single or double wave soldering process according to C&K Procedure PS-LF-001

- Reverse Thru-Hole Terminals: Manual soldering: 3 sec / 350°C. Lead free single wave soldering process can be used but validation of the process must be done by customer

Note: Specifications and materials listed above are for switches with standard options. For information on specific and custom switches, consult Customer Service Center.

How To Order

The Build-A Switch concept allows you to mix and match options to create the switch you need. Below is a complete listing of options shown in catalog. To order, simply select desired option from each category and place in the appropriate box.

NOTE: Some of the configurations may not be available or could require some development.



Number of Positions

- RTE04** **ESD Protection and top plate**
- RTE10** **0** Without ESD - standard plate
- RTE16** **1** With ESD - standard plate ²
- B** Without ESD - black plate

- Actuator**
- 0** Flush, screwdriver slot
- 2** Shaft for button

- Terminations**
- N** Thru-hole
- V** Right angle
- G** Surface mount
- R** Reverse, thru-hole

- Switch Function**
- 0** Single pole ¹
- 1** BCD code
- 3** Gray Code (for RTE 10)
- 4** Hexadecimal code (for RTE 16)
- 7** Gray Code (for RTE16)

- Contact/Terminal Material**
- 4** Gold 0.5 μ m/ lead free tin
- 7** Gold 1.0 μ m



1 - Single pole function not available for RTE10/RTE16
2 - ESD protection available with "N" and "R" terminations only

RTE Series Low Profile Rotary DIP Switches

SWITCHES WITH STANDARD OPTIONS

PC Mount-Terminal Option N

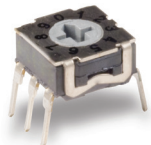

Right Angle Mount-Terminal Option V

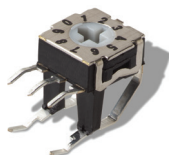

Surface Mount-Terminal Option G



NUMBER OF POSITIONS

RTE04 4 POSITIONS



RTE10 10 POSITIONS

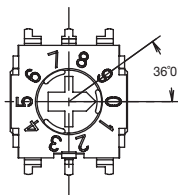

RTE16 16 POSITIONS

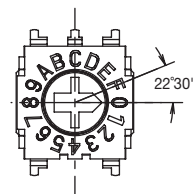

RTE Series Low Profile Rotary DIP Switches



H
DIP

ESD PROTECTION

0 WITHOUT



1 WITH



ACTUATOR

0 SCREWDRIVER SLOT



For all RTE versions



Except for RTE1000Gx4 (SMT)
RTE1600Gx4 (SMT)



2 SHAFT FOR BUTTON



Dimensions are shown: Inch (mm)
Specifications and dimensions subject to change

RTE Series Low Profile Rotary DIP Switches

TERMINATIONS

TERMINATIONS

DIP I

N THRU-HOLE



R REVERSE, THRU-HOLE



V RIGHT ANGLE, THRU-HOLE

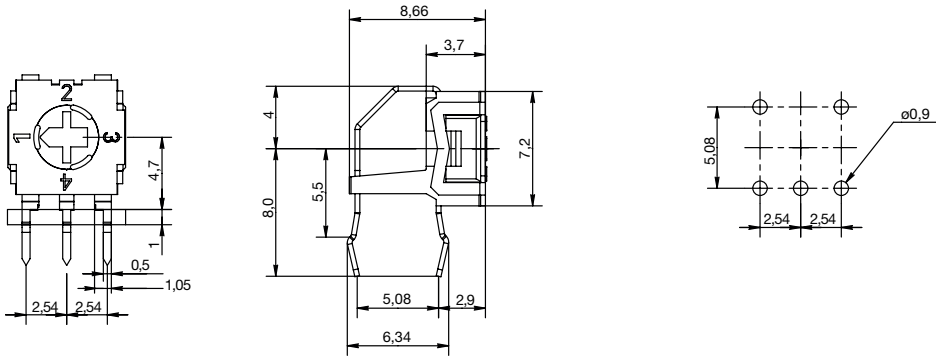

G SURFACE MOUNT

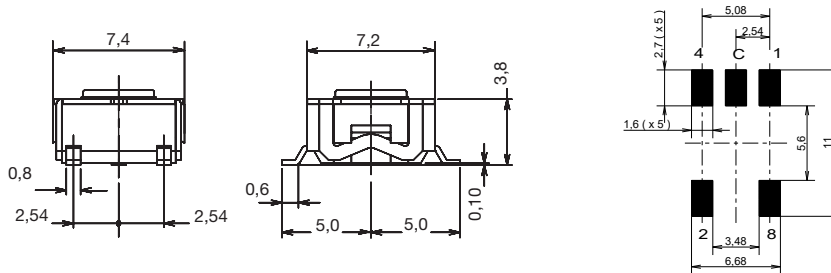

PCB layout seen component side





SWITCH FUNCTION

0 SINGLE POLE

POS.	1	2	3	4
C	●	●	●	●
1	●			
2		●		
3			●	
4				●

1 BCD CODE

POS.	0	1	2	3	4	5	6	7	8	9
C	●	●	●	●	●	●	●	●	●	●
1		●								●
2			●	●			●	●		
4					●	●	●	●		
8									●	●

3 GRAY CODE (for RTE10 only)

POS.	0	1	2	3	4	5	6	7	8	9
C	●	●	●	●	●	●	●	●	●	●
1		●	●				●	●		●
2			●	●	●					
4				●	●	●	●	●	●	●
8									●	●

4 HEXADECIMAL CODE

POS.	0	1	2	3	4	5	6	7	8	9	A	B	C	D	E	F
C	●	●	●	●	●	●	●	●	●	●	●	●	●	●	●	●
1		●				●	●			●		●		●		●
2			●	●			●	●			●		●		●	
4					●	●	●	●				●	●	●	●	●
8									●	●	●	●	●	●	●	●

7 GRAY CODE (for RTE04 only)

POS.	1	2	3	4
C	●	●	●	●
1	●			
2		●		
4			●	
8				●

(for RTE16 only)

POS.	0	1	2	3	4	5	6	7	8	9	A	B	C	D	E	F
C	●	●	●	●	●	●	●	●	●	●	●	●	●	●	●	●
1		●	●						●	●		●		●		●
2			●	●	●	●					●	●	●	●		
4					●	●	●	●	●	●	●	●	●	●	●	●
8									●	●	●	●	●	●	●	●

CONTACT MATERIAL

OPTION CODE	CONTACT MATERIAL	TERMINAL PLATING
4	Gold	0.5 μm / lead free tin
7	Gold	1.0 μm



First Angle
Projection

Dimensions are shown: Inch (mm)
Specifications and dimensions subject to change

RTE Series Low Profile Rotary DIP Switches

TAPE AND REEL

Tape and reel for RTExx02Gxx
750 pieces per reel.

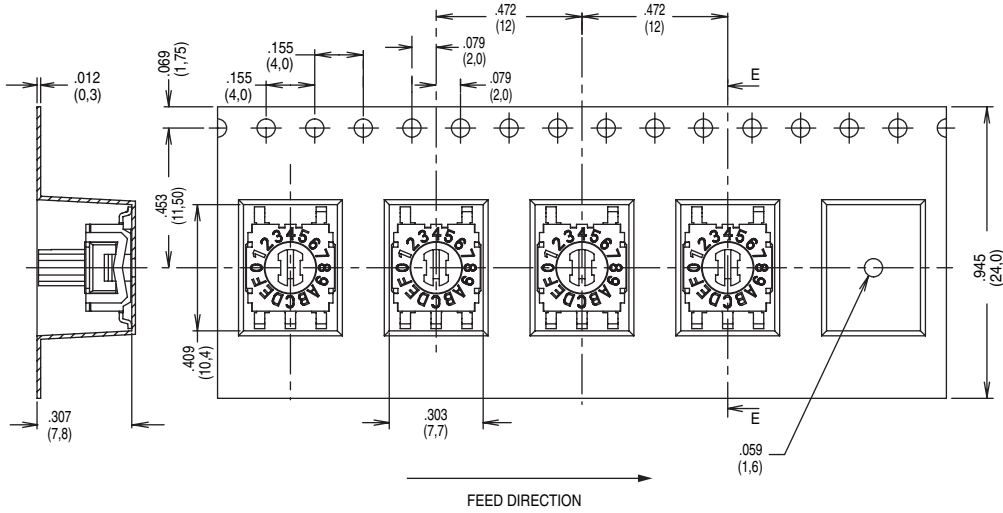

Tape and reel for RTExx00Gxx
1,250 pieces per reel.



Dimensions are shown: Inch (mm)
Specifications and dimensions subject to change

Компания «Океан Электроники» предлагает заключение долгосрочных отношений при поставках импортных электронных компонентов на взаимовыгодных условиях!

Наши преимущества:

- Поставка оригинальных импортных электронных компонентов напрямую с производств Америки, Европы и Азии, а так же с крупнейших складов мира;
- Широкая линейка поставок активных и пассивных импортных электронных компонентов (более 30 млн. наименований);
- Поставка сложных, дефицитных, либо снятых с производства позиций;
- Оперативные сроки поставки под заказ (от 5 рабочих дней);
- Экспресс доставка в любую точку России;
- Помощь Конструкторского Отдела и консультации квалифицированных инженеров;
- Техническая поддержка проекта, помощь в подборе аналогов, поставка прототипов;
- Поставка электронных компонентов под контролем ВП;
- Система менеджмента качества сертифицирована по Международному стандарту ISO 9001;
- При необходимости вся продукция военного и аэрокосмического назначения проходит испытания и сертификацию в лаборатории (по согласованию с заказчиком);
- Поставка специализированных компонентов военного и аэрокосмического уровня качества (Xilinx, Altera, Analog Devices, Intersil, Interpoint, Microsemi, Actel, Aeroflex, Peregrine, VPT, Syfer, Eurofarad, Texas Instruments, MS Kennedy, Miteq, Cobham, E2V, MA-COM, Hittite, Mini-Circuits, General Dynamics и др.);

Компания «Океан Электроники» является официальным дистрибьютором и эксклюзивным представителем в России одного из крупнейших производителей разъемов военного и аэрокосмического назначения «JONHON», а так же официальным дистрибьютором и эксклюзивным представителем в России производителя высокотехнологичных и надежных решений для передачи СВЧ сигналов «FORSTAR».



JONHON

«JONHON» (основан в 1970 г.)

Разъемы специального, военного и аэрокосмического назначения:

(Применяются в военной, авиационной, аэрокосмической, морской, железнодорожной, горно- и нефтедобывающей отраслях промышленности)

«FORSTAR» (основан в 1998 г.)

ВЧ соединители, коаксиальные кабели,
кабельные сборки и микроволновые компоненты:

(Применяются в телекоммуникациях гражданского и специального назначения, в средствах связи, РЛС, а так же военной, авиационной и аэрокосмической отраслях промышленности).



Телефон: 8 (812) 309-75-97 (многоканальный)

Факс: 8 (812) 320-03-32

Электронная почта: ocean@oceanchips.ru

Web: <http://oceanchips.ru/>

Адрес: 198099, г. Санкт-Петербург, ул. Калинина, д. 2, корп. 4, лит. А