

50 ohm, conjugate match to CC2541 transformer balun

Datasheet – production data

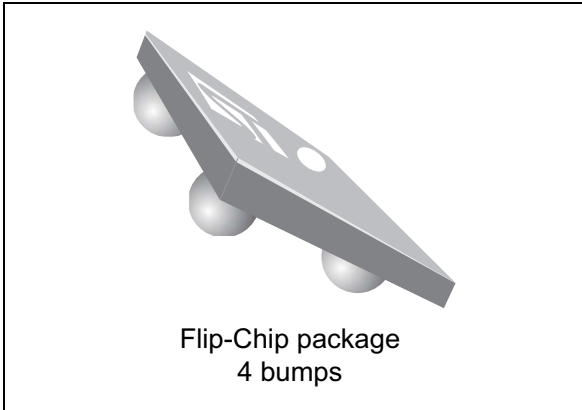

Description

STMicroelectronics BAL-CC25-02D3 is an ultra miniature balun which integrates a matching network in a monolithic glass substrate. This has been customized for the CC2541 RF transceivers.

It's a design using STMicroelectronics IPD (integrated passive device) technology on non-conductive glass substrate to optimize RF performance.

Features

- 2.45 GHz balun with integrated matching network
- Matching optimized for following CC2541
- Low insertion loss
- Low amplitude imbalance
- Low phase imbalance
- Coated Flip-Chip on glass
- Small footprint: < 0.88 mm²

Benefits

- Very low profile
- High RF performance
- PCB space saving versus discrete solution
- BOM count reduction
- Efficient manufacturability

Figure 1. Pin configuration (top view)

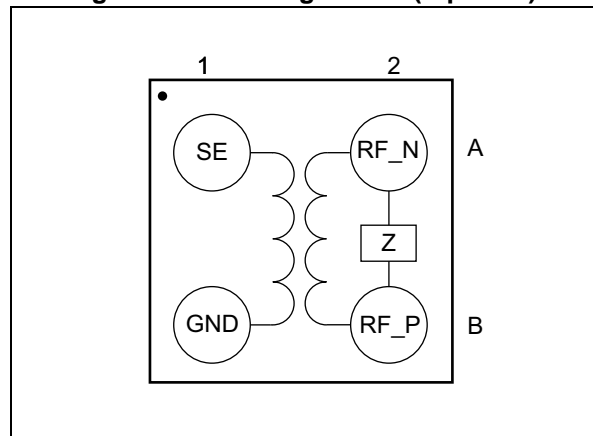
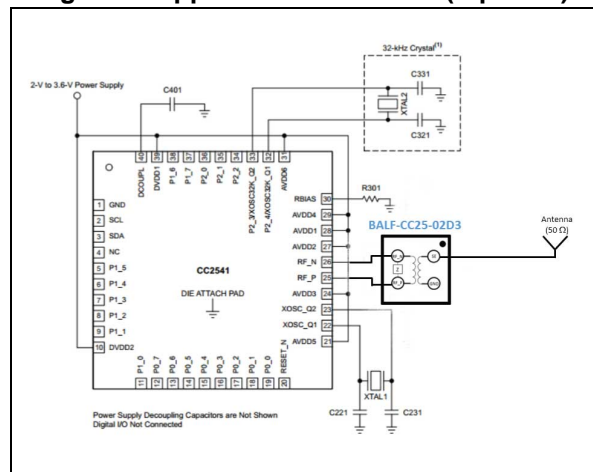

Figure 2. Application schematic (top view)



1 Characteristics

Table 1. Absolute maximum rating (limiting values)

Symbol	Parameter	Value	Unit
P_{IN}	Input power RF_{IN}	20	dBm
V_{ESD}	ESD ratings MIL STD883C (HBM: C = 100 pF, R = 1.5 Ω , air discharge)	2000	V
	ESD ratings machine model (MM: C = 200 pF, R = 25 Ω , L = 500 nH)	500	
	ESD ratings charged device model (CDM, JESD22-C101D)	500	
T_{OP}	Operating temperature	-40 to + 105	$^{\circ}C$

Table 2. Electrical characteristics - RF performance ($T_{amb} = 25^{\circ}C$)

Symbol	Parameter	Value			Unit
		Min.	Typ.	Max.	
Z_{OUT}	Nominal differential output impedance	Conjugate match to CC2541			Ω
Z_{IN}	Nominal input impedance		50		
F	Frequency range (bandwidth)	2379		2507	
I_L	Insertion loss in bandwidth		1.6	1.8	dB
R_{L_SE}	Single ended return loss in bandwidth	9	10		dB
R_{L_DIFF}	Differential ended return loss in bandwidth	9	17		dB
Φ_{imb}	Phase imbalance		7		$^{\circ}$
A_{imb}	Amplitude imbalance		0.6		dB

Figure 3. Balun transmission ($T_{amb} = 25\text{ }^{\circ}\text{C}$)

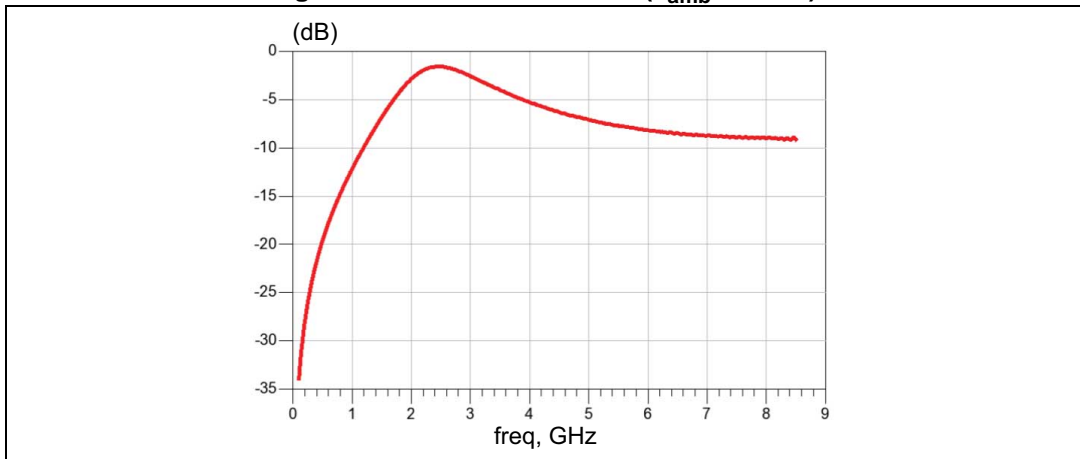

Figure 4. Insertion loss ($T_{amb} = 25\text{ }^{\circ}\text{C}$)

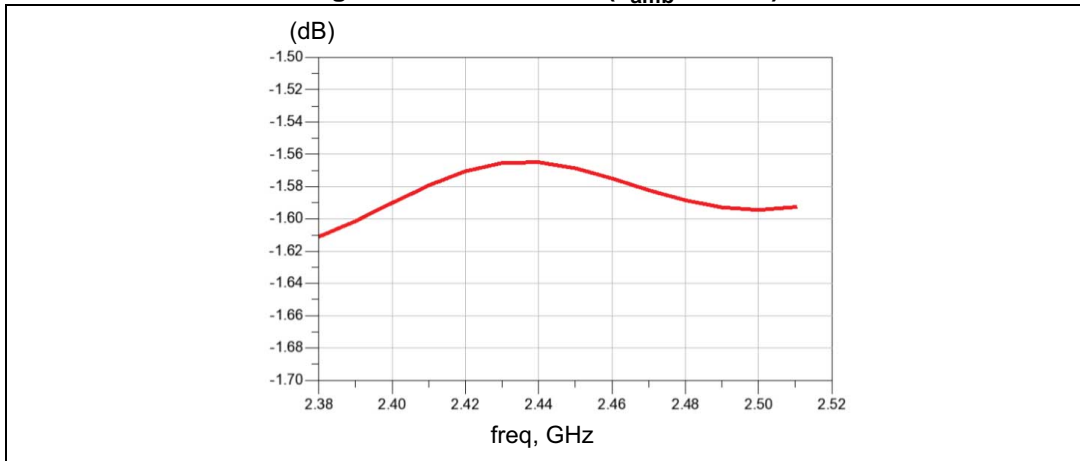

Figure 5. Return loss on SE port ($T_{amb} = 25\text{ }^{\circ}\text{C}$)

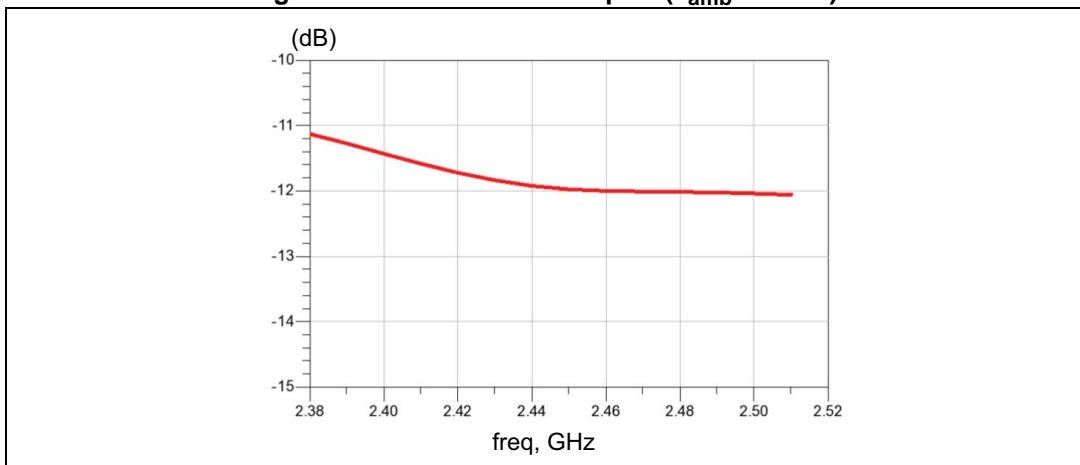

Figure 6. Return loss on DIFF port ($T_{amb} = 25\text{ }^{\circ}\text{C}$)

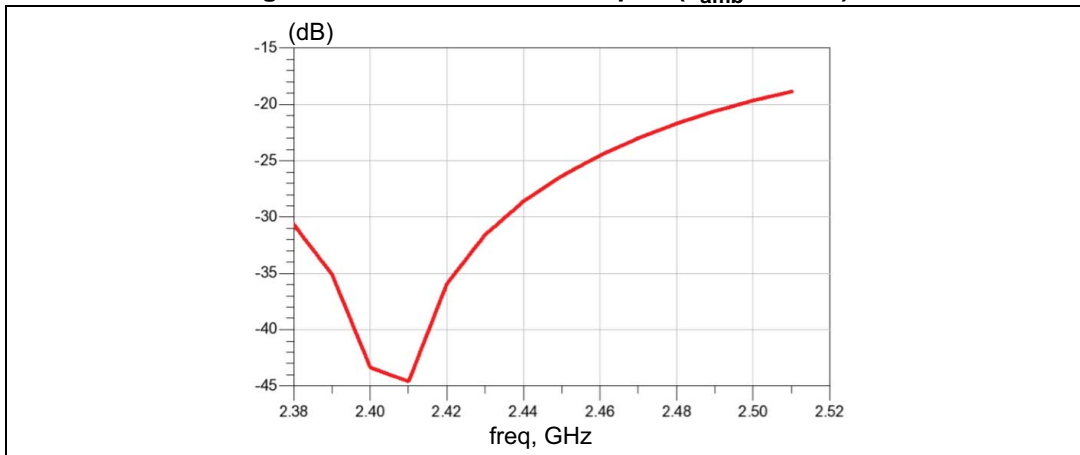

Figure 7. Amplitude imbalance ($T_{amb} = 25\text{ }^{\circ}\text{C}$)

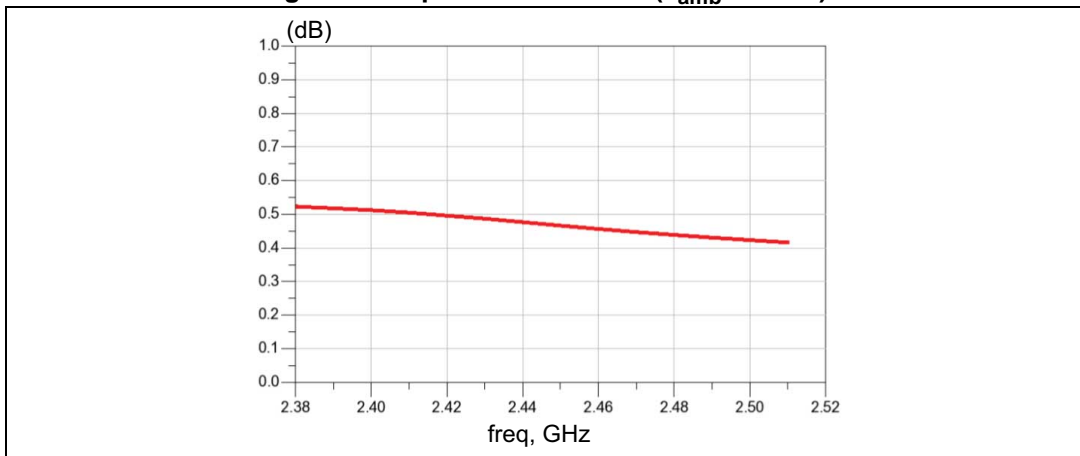
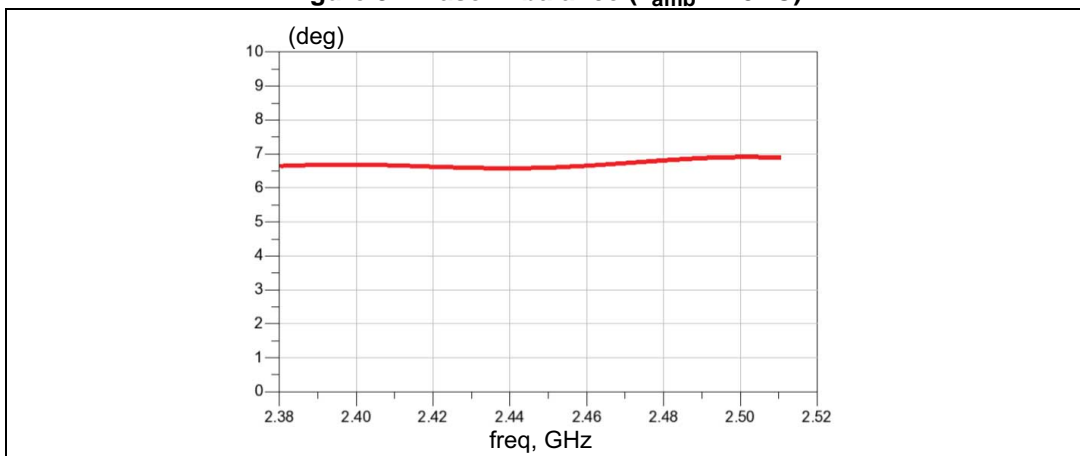

Figure 8. Phase imbalance ($T_{amb} = 25\text{ }^{\circ}\text{C}$)



2 Package information

- Epoxy meets UL94, V0
- Lead-free package

In order to meet environmental requirements, ST offers these devices in different grades of ECOPACK[®] packages, depending on their level of environmental compliance. ECOPACK[®] specifications, grade definitions and product status are available at: www.st.com. ECOPACK[®] is an ST trademark.

2.1 Flip-Chip package information

Figure 9. Flip-Chip package outline

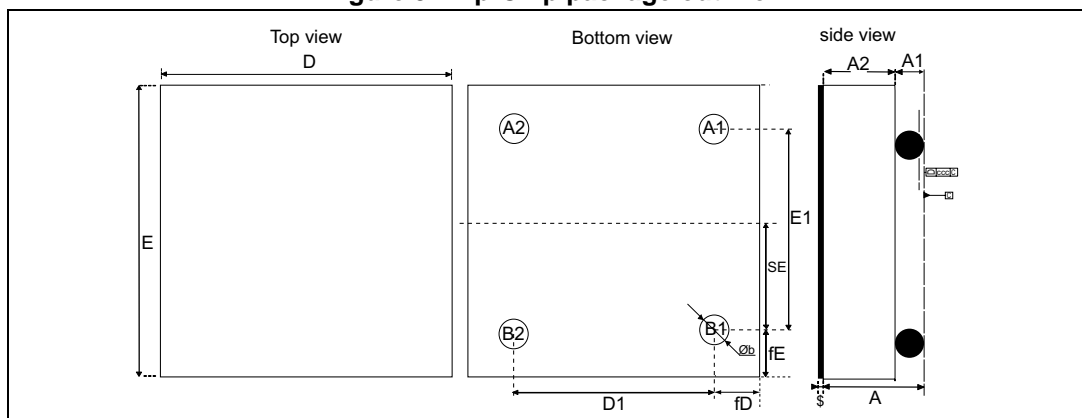

Table 3. Flip-Chip package mechanical data

Parameter	Description	Min.	Typ.	Max.	Unit
A	Bump height + substrate thickness	0.570	0.630	0.690	mm
A1	Bump height	0.155	0.205	0.255	mm
A2	Substrate thickness		0.400		mm
b	Bump diameter	0.215	0.255	0.295	mm
D	Y dimension of the die	0.890	0.940	0.990	mm
D1	Y pitch		0.500		mm
E	X dimension of the die	0.890	0.940	0.990	mm
E1	X pitch		0.500		mm
SE			0.250		mm
fD	Distance from bump to edge of die on Y axis		0.220		mm
fE	Distance from bump to edge of die on X axis		0.220		mm
ccc				0.05	mm
\$			0.025		mm

Figure 10. Footprint

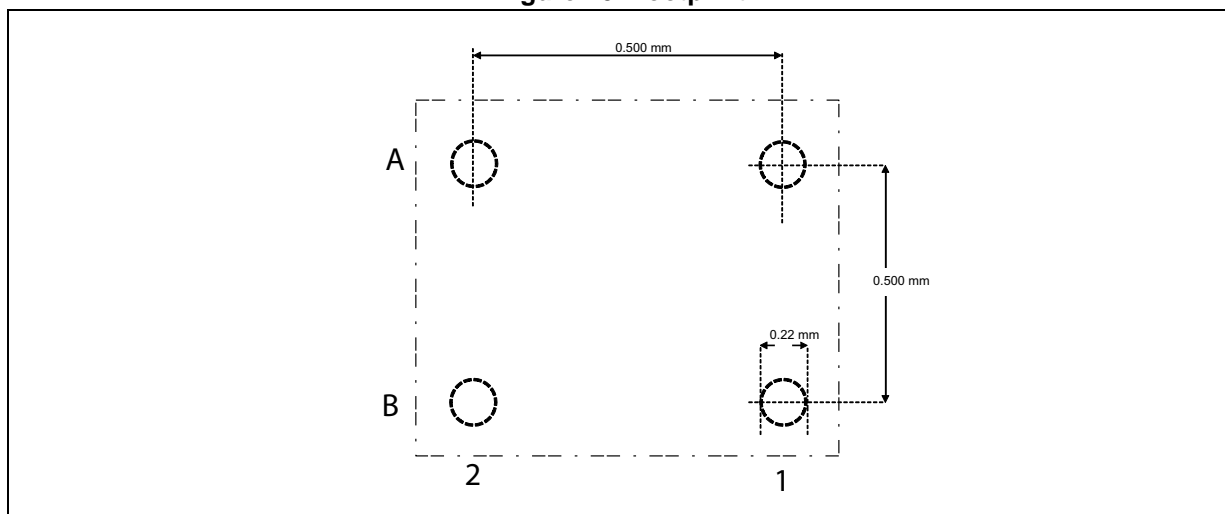

Figure 11. Bump coordinates (top view)

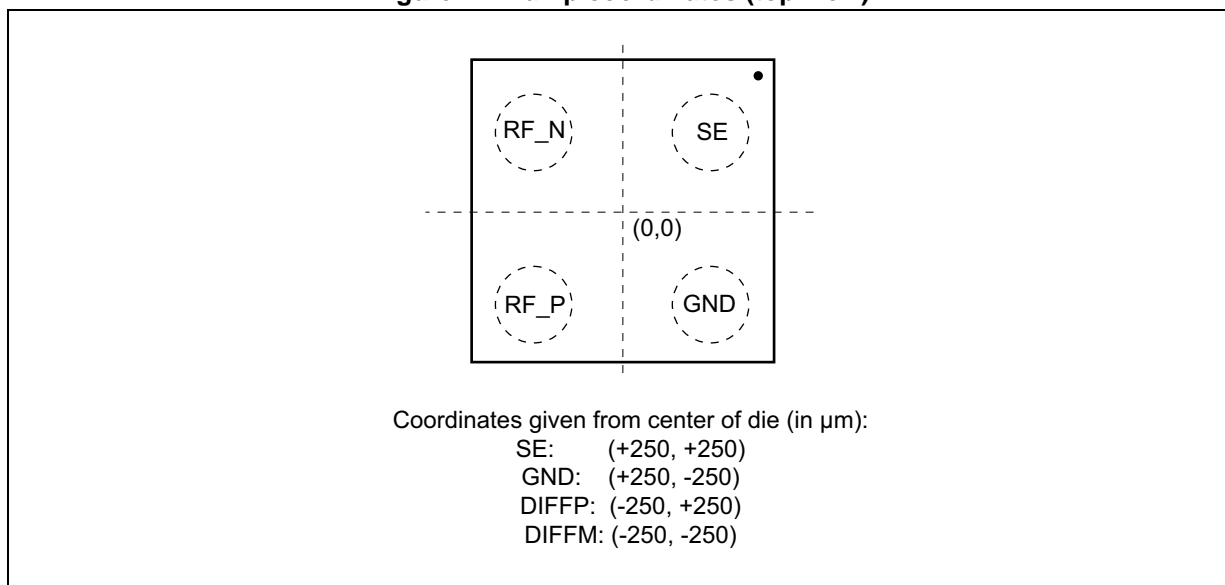

Figure 12. Footprint - 3 mils stencil - non solder mask defined

Copper pad diameter:
 220 μm recommended
 180 μm minimum
 260 μm maximum

Solder mask opening:
 320 μm recommended
 300 μm minimum
 340 μm maximum

Solder stencil opening:
 220 μm recommended

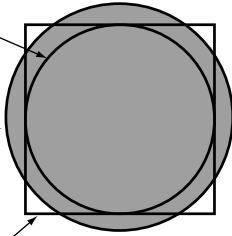

Figure 13. Footprint - 3 mils stencil - solder mask defined

Solder mask opening:
 220 μm recommended
 180 μm minimum
 260 μm maximum

Copper pad diameter:
 320 μm recommended
 300 μm minimum

Solder stencil opening:
 220 μm recommended

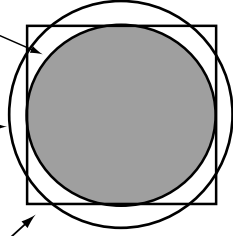

Figure 14. Footprint - 5 mils stencil - non solder mask defined

Copper pad diameter:
 220 μm recommended
 180 μm minimum
 260 μm maximum

Solder mask opening:
 320 μm recommended
 300 μm minimum
 340 μm maximum

Solder stencil opening:
 330 μm recommended*

*depending on paste, it can go down to 270 μm

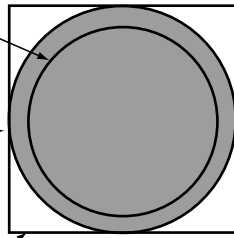

Figure 15. Footprint - 5 mils stencil - solder mask defined

Solder mask opening:
 220 μm recommended
 180 μm minimum
 260 μm maximum

Copper pad diameter:
 320 μm recommended
 300 μm minimum

Solder stencil opening:
 330 μm recommended*

*depending on paste, it can go down to 270 μm

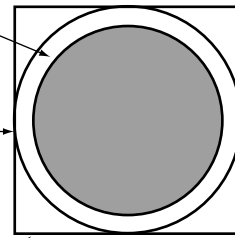

Figure 16. PCB layout recommendation

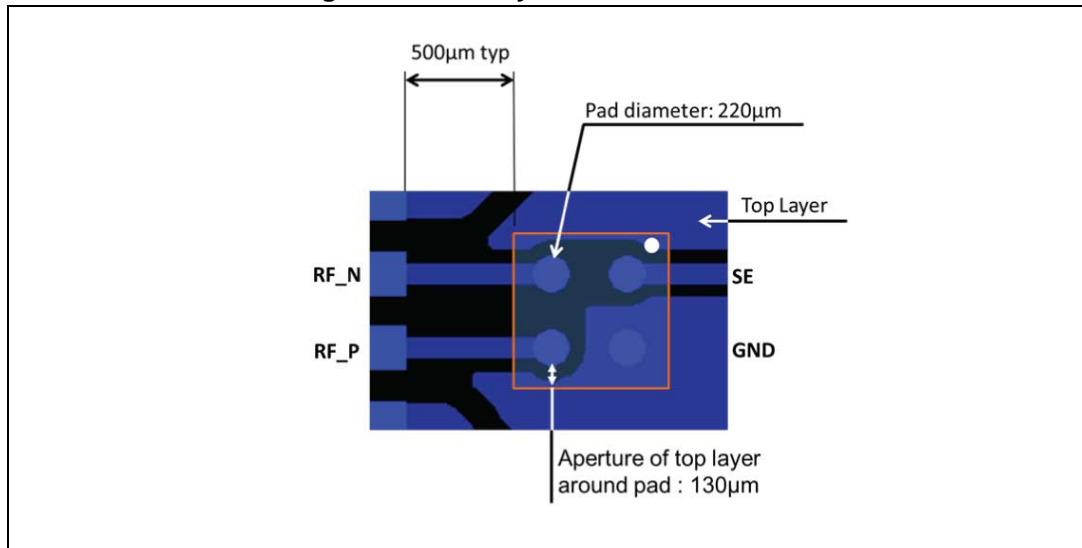
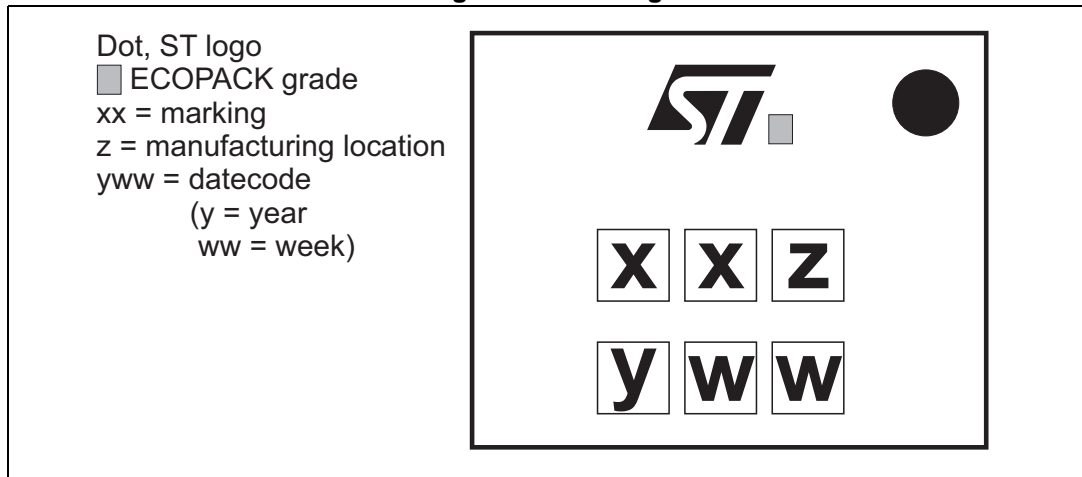
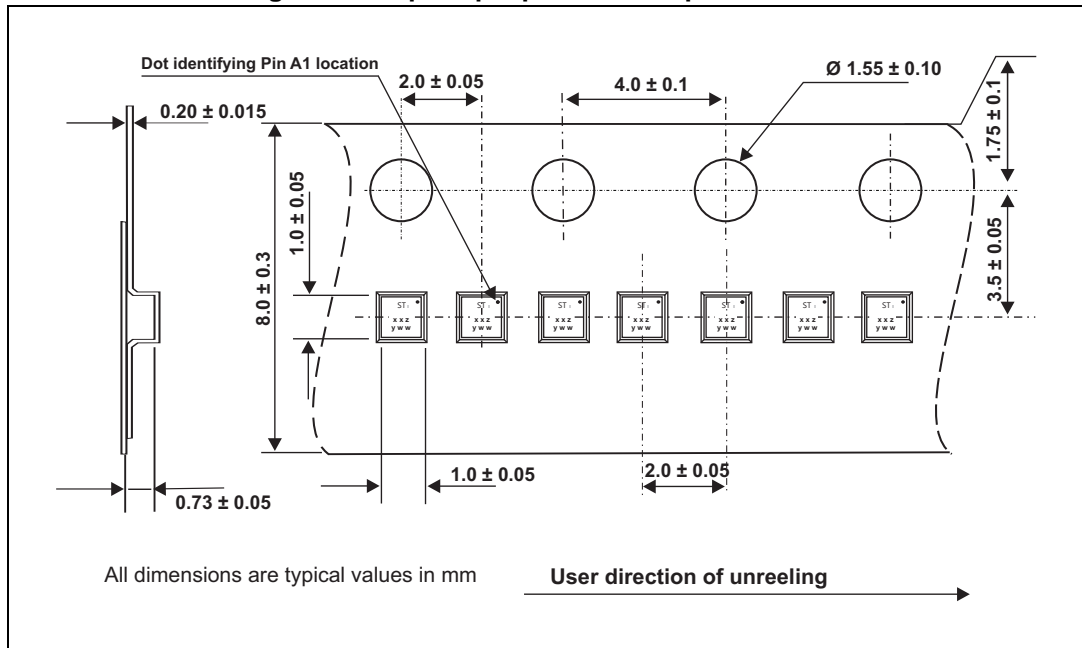

Figure 17. Marking



Note: More information is available in the STMicroelectronics Application note: AN2348 Flip-Chip: "Package description and recommendations for use"

Figure 18. Flip Chip tape and reel specifications



Note: More information is available in the application note:
 AN2348: "Flip Chip: package description and recommendations for use"

3 Ordering information

Table 4. Ordering information

Order code	Marking	Package	Weight	Base qty	Delivery mode
BAL-CC25-02D3	TE	Flip Chip	1.07 mg	5000	Tape and reel (7")

4 Revision history

Table 5. Document revision history

Date	Revision	Changes
17-Nov-2015	1	Initial release

IMPORTANT NOTICE – PLEASE READ CAREFULLY

STMicroelectronics NV and its subsidiaries ("ST") reserve the right to make changes, corrections, enhancements, modifications, and improvements to ST products and/or to this document at any time without notice. Purchasers should obtain the latest relevant information on ST products before placing orders. ST products are sold pursuant to ST's terms and conditions of sale in place at the time of order acknowledgement.

Purchasers are solely responsible for the choice, selection, and use of ST products and ST assumes no liability for application assistance or the design of Purchasers' products.

No license, express or implied, to any intellectual property right is granted by ST herein.

Resale of ST products with provisions different from the information set forth herein shall void any warranty granted by ST for such product.

ST and the ST logo are trademarks of ST. All other product or service names are the property of their respective owners.

Information in this document supersedes and replaces information previously supplied in any prior versions of this document.

© 2015 STMicroelectronics – All rights reserved

Компания «Океан Электроники» предлагает заключение долгосрочных отношений при поставках импортных электронных компонентов на взаимовыгодных условиях!

Наши преимущества:

- Поставка оригинальных импортных электронных компонентов напрямую с производств Америки, Европы и Азии, а так же с крупнейших складов мира;
- Широкая линейка поставок активных и пассивных импортных электронных компонентов (более 30 млн. наименований);
- Поставка сложных, дефицитных, либо снятых с производства позиций;
- Оперативные сроки поставки под заказ (от 5 рабочих дней);
- Экспресс доставка в любую точку России;
- Помощь Конструкторского Отдела и консультации квалифицированных инженеров;
- Техническая поддержка проекта, помощь в подборе аналогов, поставка прототипов;
- Поставка электронных компонентов под контролем ВП;
- Система менеджмента качества сертифицирована по Международному стандарту ISO 9001;
- При необходимости вся продукция военного и аэрокосмического назначения проходит испытания и сертификацию в лаборатории (по согласованию с заказчиком);
- Поставка специализированных компонентов военного и аэрокосмического уровня качества (Xilinx, Altera, Analog Devices, Intersil, Interpoint, Microsemi, Actel, Aeroflex, Peregrine, VPT, Syfer, Eurofarad, Texas Instruments, MS Kennedy, Miteq, Cobham, E2V, MA-COM, Hittite, Mini-Circuits, General Dynamics и др.);

Компания «Океан Электроники» является официальным дистрибьютором и эксклюзивным представителем в России одного из крупнейших производителей разъемов военного и аэрокосмического назначения «JONHON», а так же официальным дистрибьютором и эксклюзивным представителем в России производителя высокотехнологичных и надежных решений для передачи СВЧ сигналов «FORSTAR».



JONHON

«JONHON» (основан в 1970 г.)

Разъемы специального, военного и аэрокосмического назначения:

(Применяются в военной, авиационной, аэрокосмической, морской, железнодорожной, горно- и нефтедобывающей отраслях промышленности)

«FORSTAR» (основан в 1998 г.)

ВЧ соединители, коаксиальные кабели, кабельные сборки и микроволновые компоненты:

(Применяются в телекоммуникациях гражданского и специального назначения, в средствах связи, РЛС, а так же военной, авиационной и аэрокосмической отраслях промышленности).



Телефон: 8 (812) 309-75-97 (многоканальный)

Факс: 8 (812) 320-03-32

Электронная почта: ocean@oceanchips.ru

Web: <http://oceanchips.ru/>

Адрес: 198099, г. Санкт-Петербург, ул. Калинина, д. 2, корп. 4, лит. А