

Electromechanical Relays Selection Guide

Latching

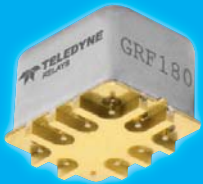

JAN



Non-Latching



RF



Loopback



Established
Reliability

Surface-Mount

4PST



Environmental



Attenuated



**TELEDYNE
RELAYS**

Everywhere you look™



RoHS or Non-RoHS:
Your Choice!



Switching Solutions

Teledyne Relays has been the world's innovative leader in the manufacture of ultraminiature, hermetically sealed, electromechanical and solid-state switching products for more than 50 years. The company's comprehensive product line meets a wide range of requirements for defense and aerospace, industrial, commercial, medical and RF & wireless applications.

Business Focus

- MIL QPL & COTS Solid-State Relays
- MIL QPL & COTS Electromechanical Relays
- HiRel (Space) Electromechanical Relays
- RF & Microwave Relays & Coaxial Switches
- Industrial Solid-State Relays
- Switching Matrices

Markets

- Commercial & Military Aviation
- Defense & Aerospace
- Telecom/Communications (Wireless)
- Instrumentation & Test
- Industrial Power & Motion Control
- Medical Applications

Product Assurance

Under an aggressive Total Quality Management (TQM) program, Teledyne Relays has embraced a "continuous improvement" culture. With recognized certifications such as Boeing D6-82479, MIL-STD-790, AS/EN/JISQ9100:2009 (Rev C) and ISO 9001:2008 Teledyne Relays has become a primary supplier of switching solutions with the highest quality and reliability to industry leaders around the world.

Technical Service & Customer Support

Teledyne Relays provides easy access to technical service and customer support. Our websites make it easy to find technical information, buy products and even get e-mail responses within 24 hours. Switching solutions are only a mouse click away at www.teledynereleys.com or at teledyne-europe.com. Information about coax switches is available at www.teledynecoax.com.

 Two Teledyne Relays components are shown against a grid background. A blue DNA double helix graphic is overlaid on the components. The component on the left is a cylindrical metal part with 'TELEDYNE' and '0-5' markings. The component on the right is a yellow cylindrical part with a multi-pin connector.

Teledyne Relays offer superior signal integrity up to 12 Gbps. See the RF relays section in our website.

Table of Contents

RF RELAYS		
Series	Description	Page
LB/GLB/SGLB363	LoopBack Relay with Built-in AC Bypass Capacitors	4-5
RF/GRF/SGRF/SRF300 RF/GRF/SGRF/SRF303	High Repeatability, Broadband TO-5 Relays, Non-Latching DPDT	6
RF/GRF/SGRF312 RF/GRF/SGRF332	High Repeatability, Broadband TO-5 Relays, Non-Latching DPDT	7
RF/GRF/SGRF100 RF/GRF/SGRF103	High Repeatability, Broadband Centigrad® Relays, Non-Latching DPDT	8
GRF172	Surface-Mount Centigrad® RF Relays, Non-Latching DPDT	8
RF/GRF311 RF/GRF331	High Repeatability, Broadband TO-5 Relays, Non-Latching SPDT	9
RF341/GRF341	Broadband TO-5 RF Relays, Magnetic-Latching SPDT	9
RF255/257	High Power DPDT Half-Size Crystal Can Relay	10
GRF342	Surface-Mount TO-5 RF Relays, Magnetic-Latching DPDT	10
RF180/GRF180	Broadband RF Relays, Magnetic-Latching DPDT	11
RF/GRF/SGRF424	Surface-Mount 4PST TO-5 Relay	12
RF310/RF313	High Repeatability TO-5 Relays, Normally Closed, Bypass	13
RF320/RF323	High Repeatability TO-5 Relays, Normally Open, Bypass	13
A150/GA150	Broadband Attenuator RF Relay	14
A152/GA152	Broadband Attenuator RF Relay	14
COMMERCIAL RELAYS		
122C	Centigrad® Relays (CMOS Compatible), Magnetic-Latching DPDT	15
172	Centigrad® Relays, Non-Latching DPDT	15
712	TO-5 Relays, Non-Latching DPDT	16
722	TO-5 Relays, Magnetic-Latching DPDT	14
732	TO-5 Relays, Non-Latching Sensitive DPDT	17
COMMERCIAL SURFACE-MOUNT RELAYS		
S114	Surface-Mount Centigrad® Relays, Non-Latching DPDT	18
S134	Surface-Mount Centigrad® Relays, Non-Latching Sensitive DPDT	18
S172	Surface-Mount Centigrad® Relays, Non-Latching DPDT	19
S422	Surface-Mount TO-5 Relays, Magnetic-Latching DPDT	19

See specific series for additional features and options

Continued on next page

Table of Contents

ESTABLISHED RELIABILITY RELAYS		
Series	Description	Page
ER114	Centigrid® Relays, Non-Latching DPDT	20
ER116C	Centigrid® Relays (CMOS Compatible), Non-Latching DPDT	20
ER134	Centigrid® Relays, Non-Latching Sensitive DPDT	21
ER136C	Centigrid® Relays (CMOS Compatible), Non-Latching Sensitive DPDT	21
ER411	TO-5 Relays, Non-Latching SPDT	22
ER431	TO-5 Relays, Non-Latching Sensitive SPDT	20
ER412	TO-5 Relays, Non-Latching DPDT	23
ER432	TO-5 Relays, Non-Latching Sensitive DPDT	23
255/257	Half-Size Crystal Can, Magnetic-Latching DPDT	24
ER421	TO-5 Relays, Magnetic-Latching SPDT	24
ER420	TO-5 Relays, Magnetic-Latching DPDT	25
ER422	TO-5 Relays, Magnetic-Latching DPDT	25
MILITARY QUALIFIED (JAN) RELAYS		
J114	Centigrid® Relays, Non-Latching DPDT	26
J116C	Centigrid® Relays (CMOS Compatible), Non-Latching DPDT	26
J134	Centigrid® Relays, Non-Latching Sensitive DPDT	27
J136C	Centigrid® Relays (CMOS Compatible), Non-Latching Sensitive DPDT	27
J411	TO-5 Relays, Non-Latching SPDT	28
J431	TO-5 Relays, Non-Latching Sensitive SPDT	28
J412	TO-5 Relays, Non-Latching DPDT	29
J432	TO-5 Relays, Non-Latching Sensitive DPDT	29
J255	Half-Size Crystal Can, Magnetic-Latching DPDT	30
J421	TO-5 Relays, Magnetic-Latching SPDT	30
J420	TO-5 Relays, Magnetic-Latching DPDT	31
J422	TO-5 Relays, Magnetic-Latching DPDT	31

See specific series for additional features and options

Continued on next page

Table of Contents

HIGH-PERFORMANCE RELAYS		
Description		Page
412H/432H	High-Temperature (200°C) TO-5 Relays, Non-Latching DPDT	32
422H	High-Temperature (200°C) TO-5 Relays, Magnetic-Latching DPDT	32
412K	High-Shock TO-5 Relays, Non-Latching DPDT	33
422K	High-Shock TO-5 Relays, Magnetic-Latching DPDT	33
412V/432V	High-Vibration TO-5 Relays, Non-Latching DPDT	34
APPENDIX		
	Signal Integrity Eye Diagrams	35-44
	RoHS and Reach Certificate of Compliance	45
	Part Numbering System	46-47
	Handling Guidelines	48
	Relay Operation	49
	Spacer Pad Options	50
	Spreader Pad Options	51
	Ground Pin Options	52
	Established Reliability Program	53-54
	Teledyne Relays HI-REL Program	55

 <p>GRF Option TO-5 Relays with straight butt pins for surface-mount applications * RF Relays Only</p>	 <p>SGRF Option TO-5 Relays with Gull-Wing (J-Lead) pins for surface-mount applications * RF Relays Only</p>	 <p>GRF Option Centigrad® Relays with straight butt pins for surface-mount applications * RF Relays Only</p>
 <p>SGRF Option TO-5 Relays with Gull-Wing (J-Lead) pins for surface-mount applications * RF Relays Only</p>	 <p>SRF Option Relays with Gull-Wing (J-Lead) pins for surface-mount applications * RF Relays Only</p>	 <p>/S Option Relays with 0.187" trimmed leads See Appendix: Part Numbering System</p>
 <p>Spacer Pad Option Relays with polyester film pad to space between PCB and Relay Header See Appendix: Spacer Pad Options</p>	 <p>Spreader Pad Option Relays with Diallyl Phthalate pad to spread pins See Appendix: Spreader Pad Options</p>	 <p>/Q, /R Option Relays with solder dipped leads. Pb/Sn (60/40) or RoHS solder available See Appendix: Part Numbering System</p>

See specific series for additional features and options



LOOPBACK RELAYS

Series LB363/GLB363/SGLB363 Electromechanical Relays

The LoopBack Series relays combines to DPDT electromechanical relays in one package that includes an internal bypass path for Automated Test Equipment (ATE) applications. The LoopBack combines the technology of two Teledyne SGRF303 Series relays and eliminates the need for external PCB traces in loop back applications. This innovation results in superior signal integrity and RF performance while taking minimal board space. The internal structure of the LoopBack relays reduces the number of discontinuities and shortens the signal path during loop back testing, providing lower insertion loss and higher signal integrity performance than two SGRF303 Series relays. This LoopBack Relay is available with surface mount ground shield and J-lead configuration to provide improved high data rate and high frequency performance and ease of surface mount attachment.

- Excellent Signal integrity up to 16Gbps
- Hermetically Sealed
- High Resistance to ESD
- Metal Enclosure for EMI shielding
- High Repeatability
- Broader bandwidth
- Through-hole or surface-mount configurations

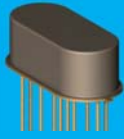
Relay Type
Two DPDT Relays
Capacitor Value
100 = 100nF
010 = 10nF
Mounting
LB = Thru-hole
GLB = Surface-Mount
Ground Shield (Stub)
SGLB = Surface-Mount
Ground Shield(J-Lead)
Temperature
Storage: -65°C to +125°C
Operating: -55°C to +85°C

Part Number	LB363	GLB363	SGLB363
			
Voltage (Vdc)	5,12	5,12	5,12
Coil Resistance (Ω)	56, 400	56, 400	56, 400
Frequency (GHz)	DC-6	DC-6	DC-6

	AC Bypass Path (Thru-CAP)			Through Path			AC Bypass Path (Thru-CAP)			Through Path		
	Single-Ended Bit Rate @ 12 Gbps			Single-Ended Bit Rate @ 12 Gbps			Single-Ended Bit Rate @ 16 Gbps			Single-Ended Bit Rate @ 16 Gbps		
	Eye Height (mV)	Eye Width (ps)	Jitter p-p (ps)	Eye Height (mV)	Eye Width (ps)	Jitter p-p (ps)	Eye Height (mV)	Eye Width (ps)	Jitter p-p (ps)	Eye Height (mV)	Eye Width (ps)	Jitter p-p (ps)
LB363	289	75	8.53	385	70.5	10.67	170	46.0	16.44	262	49.8	11.33
GLB363	318	74.1	8.8	398	73.1	10.4	157	49.4	14.22	251	49.2	10.67
SGLB363	329	74.2	7.2	395	73	11.2	173	48.3	12.67	288	47.9	11.56

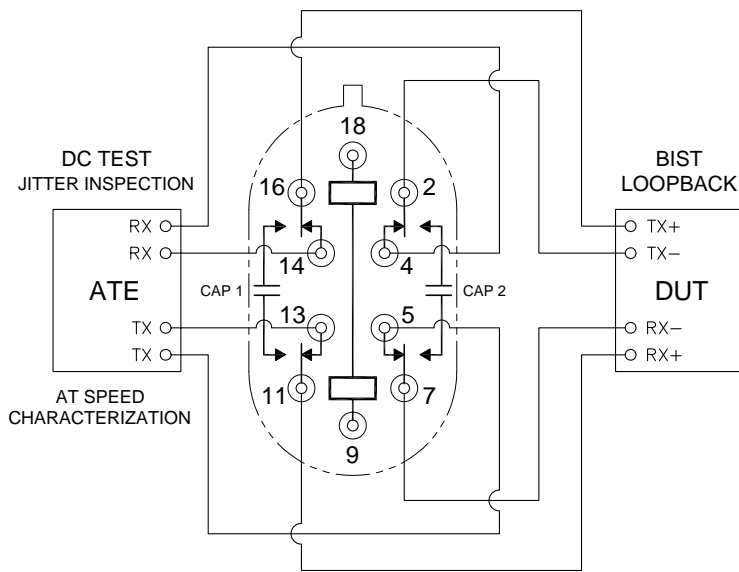

(Contacts shown in De-Energized position)

Figure 1: Single LoopBack Relay

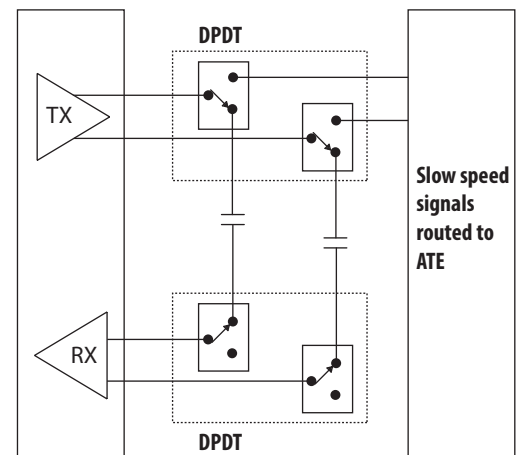
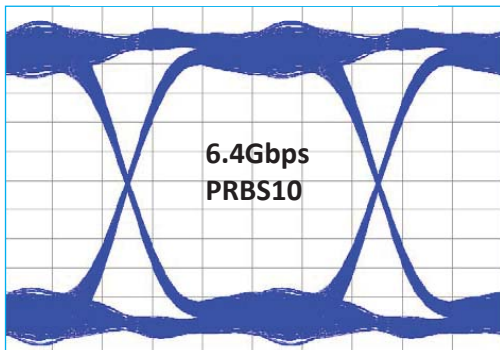

Figure 2: 2 DPDT Relays with external capacitors

LOOPBACK RELAYS

Dual SGRF303 Loopback



Single LB363 Loopback

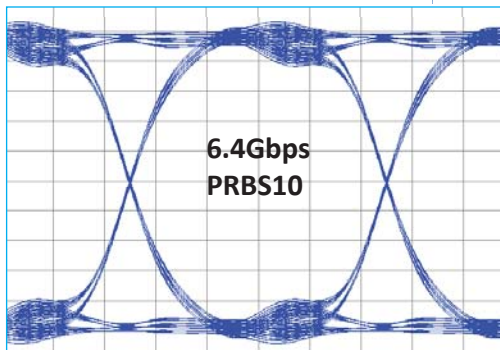

Dual SGRF303 Loopback

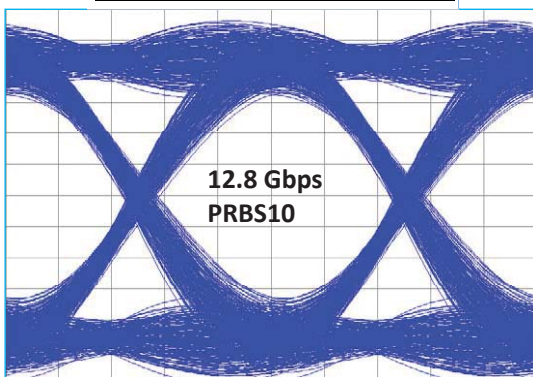

Single LB363 Loopback

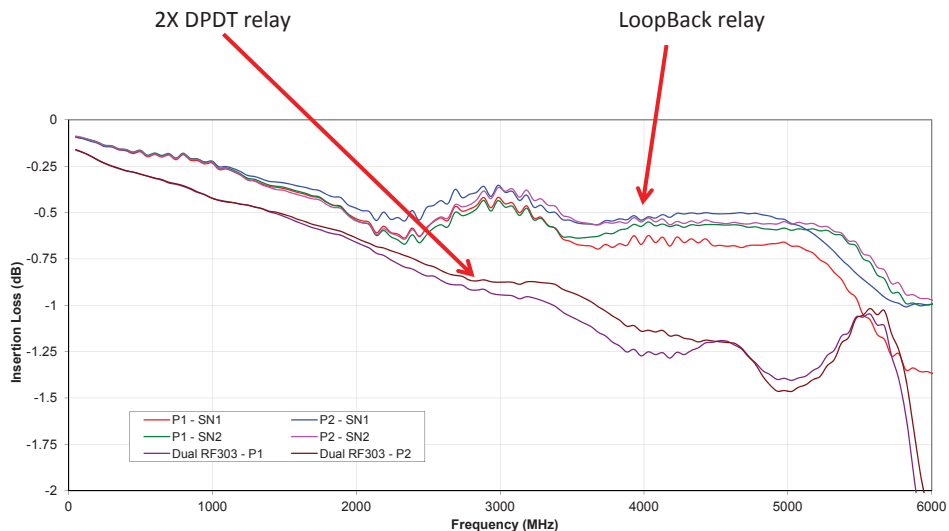
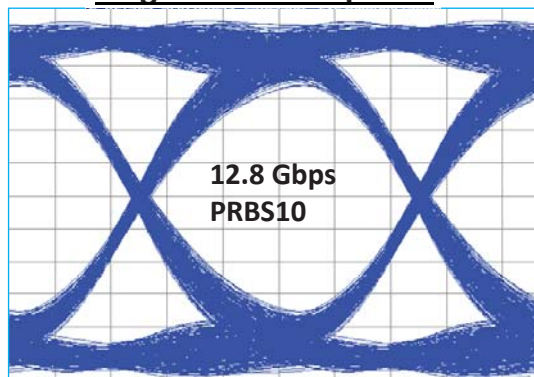

A single LB363 has better Insertion Loss performance than 2 SGRF303 relays in a LoopBack application

RF RELAYS

Series RF300/RF303 Electromechanical Relays





The RF300 and RF303 TO-5 relays are designed to provide improved RF signal repeatability over the frequency range. The RF300 Series is offered with a standard or sensitive coil.

The GRF300 and GRF303 TO-5 relays feature a unique ground shield that isolates and shields each lead to ensure excellent contact-to-contact and pole-to-pole isolation. This ground shield provides a ground interface that results in improved high-frequency performance as well as parametric repeatability.

The SGRF300 and SGRF303 TO-5 relays extend performance advantages over similar RF devices that simply offer formed leads for surface mounting.

- Excellent Signal integrity up to 18Gbps+
- Hermetically Sealed
- High Resistance to ESD
- Metal Enclosure for EMI shielding
- High Repeatability
- Broader bandwidth
- Through-hole or surface-mount configurations

Relay Type
DPDT Non-Latching
Coil Type
300 = Standard Coil 303 = Sensitive Coil
Diode Option
D = Internal diode for coil transient suppression DD = Internal diode for coil transient suppression and polarity reversal protection
Mounting
RF = Thru-hole GRF = Surface-Mount (Stub) SGRF = Surface-Mount (J-Lead) SRF = Surface Mount (J-Lead)
Temperature
Storage: -65°C to +125°C Operating: -55°C to +85°C

Part No.	Nominal Coil		Typical RF Performance				
	Voltage (Vdc)	Resistance (Ω)	Frequency (GHz)	VSWR (max)	Isolation (dB)		Insertion Loss (dB) (max)
					Pole to Pole (min)	Across Contacts (min)	
 RF300	5	50	DC-1	1.1 : 1	30	25	0.2
RF300D	12	390	1-2	1.1 : 1	25	20	0.3
RF303	5	100	2-3	1.2 : 1	25	20	0.4
RF303D	12	850					
 GRF300	5	50	DC-1	1.1 : 1	40	30	0.2
GRF300D	12	390	1-3	1.1 : 1	40	30	0.2
GRF303	5	100	3-4	1.3 : 1	30	30	0.6
GRF303D	12	850	4-6	1.6 : 1	25	25	1.0
 SGRF300	5	50	DC-1	1.2 : 1	40	30	0.2
SGRF300D	12	390	1-3	1.2 : 1	40	30	0.4
SGRF303	5	100	3-4	1.2 : 1	20	25	0.8
SGRF303D	12	850	4-6	1.8 : 1	10	20	1.0
 SRF300	5	50	DC-1	1.1 : 1	25	25	0.5
SRF300D	12	390	1-3	1.5 : 1	25	25	0.5
SRF303	5	100	3-4	2.0 : 1	15	15	3.0
SRF303D	12	850	4-6	2.5 : 1	10	10	4.0

For RF300DD & RF303DD values please see Datasheet

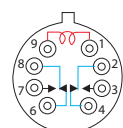

300
303

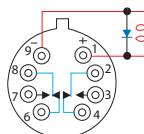

300D
303D

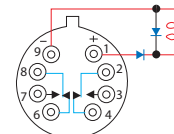

300DD
303DD

Schematics as viewed from terminals

RF RELAYS

Series RF312/RF332 Electromechanical Relays

The RF312/RF332 is designed to improve upon the RF300/RF303 relay's high frequency performance. The RF312/RF332 offers monotonic insertion loss over to 8GHz. This improvement in RF insertion loss over the frequency range, makes these relays highly suitable for use in attenuator and other RF circuits. The RF312/RF332 Series is offered with a standard or sensitive coil. The GRF312/GRF332 is designed to improve upon the GRF300/GRF303 relay's high frequency performance. The GRF312/GRF332 TO-5 relay features a unique ground shield that isolates and shields each lead to ensure excellent contact-to-contact and pole-to-pole isolation. This ground shield provides a ground interface that results in improved high-frequency performance as well as parametric repeatability. The SGRF312/SGRF332 feature a unique ground shield that isolates and shields each lead to ensure excellent contact-to-contact and pole-to-pole isolation.

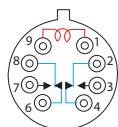

- Excellent Signal integrity up to 20 Gbps+
- Hermetically Sealed
- High Resistance to ESD
- Metal Enclosure for EMI shielding
- High Repeatability
- Broader bandwidth
- Through-hole or surface-mount configurations

Relay Type
DPDT Non-Latching
Coil Type
312 = Standard Coil
332 = Sensitive Coil
Mounting
RF = Thru-hole
GRF = Surface-Mount (Stub)
SGRF = Surface-Mount (J-Lead)
Temperature
Storage: -65°C to +125°C
Operating: -55°C to +85°C



312
332

Schematics as viewed from terminals

Part No.	Nominal Coil		Typical RF Performance				
	Voltage (Vdc)	Resistance (Ω)	Frequency (GHz)	VSWR (max)	Isolation (dB)		Insertion Loss (dB) (max)
					Pole to Pole (min)	Across Contacts (min)	
 RF312 RF332	5	50	DC-2	1.2 : 1	30	20	0.2
	12	390	2-4	1.2 : 1	25	20	0.4
	5	100	4-6	1.3 : 1	25	20	0.6
	12	850	6-8	1.4 : 1	20	20	0.8
 GRF312 GRF332	5	50	DC-2	1.4 : 1	40	30	0.3
	12	390	2-4	1.4 : 1	40	30	0.5
	5	100	4-6	1.5 : 1	35	30	1.0
	12	850	6-8	1.5 : 1	35	30	1.5
 SGRF312 SGRF332	5	50	DC-2	1.2 : 1	40	30	0.2
	12	390	2-4	1.2 : 1	35	30	0.5
	5	100	4-6	1.3 : 1	30	25	1.0
	12	850	6-8	1.5 : 1	30	25	1.5

RF RELAYS

Series RF100/RF103 Electromechanical Relays



The RF100 and RF103 Centigrad® relays are designed to provide improved RF signal repeatability over the frequency range.

The GRF100 and GRF103 Centigrad® relays feature a unique ground shield that isolates and shields each lead to ensure excellent contact-to-contact and pole-to-pole isolation. This ground shield provides a ground interface that results in improved high-frequency performance as well as parametric repeatability.

The SGRF100 and SGRF103 Centigrad® relays extend performance advantages over similar RF devices that simply offer formed leads for surface mounting.

- Excellent Signal integrity up to 18Gbps
- Hermetically Sealed
- High Resistance to ESD
- Metal Enclosure for EMI shielding
- High Repeatability
- Broader bandwidth
- Through-hole or surface-mount configurations

Relay Type
DPDT Non-Latching
Coil Type
100 = Standard Coil 103 = Sensitive Coil
Mounting
RF = Thru-hole GRF = Surface-Mount (Stub) SGRF = Surface-Mount (J-Lead)
Temperature
Storage: -65°C to +125°C Operating: -55°C to +85°C

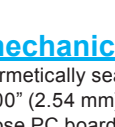
Part No.	Nominal Coil		Typical RF Performance				
	Voltage (Vdc)	Resistance (Ω)	Frequency (GHz)	VSWR (max)	Isolation (dB)		Insertion Loss (dB) (max)
					Pole to Pole (min)	Across Contacts (min)	
 RF100	5	50	DC-1	1.1 : 1	35	25	0.2
	12	390	1-2	1.5 : 1	30	20	0.5
	5	100	2-3	1.6 : 1	30	20	0.6
 GRF100	5	50	DC-1	1.1 : 1	45	30	0.2
	12	390	1-3	1.2 : 1	40	25	0.3
	5	100	3-4	1.3 : 1	35	25	0.6
 SGRF100	12	800	4-6	2.2 : 1	30	25	1.2
	5	50	DC-1	1.2 : 1	35	30	0.2
	12	390	1-3	1.3 : 1	30	30	0.7
 SGRF103	5	100	3-4	1.4 : 1	25	25	0.8
	12	800	4-6	1.8 : 1	25	25	1.0

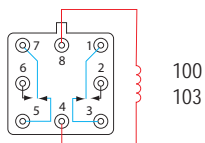

Series GRF172 Electromechanical Relays

The GRF172 Centigrad® relay is a hermetically sealed, armature relay for 2.5GHz RF applications. Its low profile height .330" (8.38 mm) and .100" (2.54 mm) grid spaced terminals make it an ideal choice where extreme packaging density and/or close PC board spacing are required. The GRF172 features a unique ground shield that isolates and shields each lead to ensure excellent contact-to-contact and pole-to-pole isolation. This ground shield provides a ground interface that results in improved high-frequency performance as well as parametric repeatability. The GRF172 extends performance advantages over similar RF devices that simply offer formed leads for surface mounting.

The Series GRF172D has an internal discrete silicon diode for coil suppression.

- Excellent Signal integrity up to 10Gbps
- Hermetically Sealed
- High Resistance to ESD
- Metal Enclosure for EMI shielding
- High Repeatability
- Broader bandwidth
- Through-hole or surface-mount configurations

Relay Type
DPDT Non-Latching
Coil Type
172 = Standard Coil
Diode Option
D = Internal diode for coil transient suppression
Mounting
GRF = Surface-Mount (Stub)
Temperature
Storage: -65°C to +125°C Operating: -55°C to +85°C

Part No.	Nominal Coil		Typical RF Performance				
	Voltage (Vdc)	Resistance (Ω)	Frequency (GHz)	VSWR (max)	Isolation (dB)		Insertion Loss (dB) (max)
					Pole to Pole (min)	Across Contacts (min)	
 GRF172	5	64	DC-1	1.1 : 1	45	30	0.2
	12	400	1-2	1.2 : 1	40	25	0.3
	26	1600	2-2.5	1.2 : 1	40	25	0.3

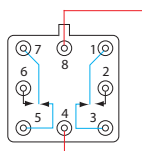

GRF172

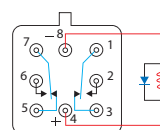

GRF172D

Schematics as viewed from terminals

RF RELAYS

Series RF311/RF331 Electromechanical Relays

The RF311/RF331 relays are designed to provide improved RF signal repeatability over the frequency range. These relays are highly suitable for use in attenuator and other RF circuits.



The GRF311 offers monotonic insertion loss to 8GHz. This improvement in RF insertion loss over the frequency range makes these relays highly suitable for use in attenuator and other RF circuits. The GRF311 features a unique ground shield that isolates and shields each lead to ensure excellent contact-to-contact isolation. This ground shield provides a ground interface that results in improved high-frequency performance as well as parametric repeatability.

- Excellent Signal integrity up to 10Gbps
- Hermetically Sealed
- High Resistance to ESD
- Metal Enclosure for EMI shielding
- High Repeatability
- Broader bandwidth
- Through-hole or surface-mount configurations

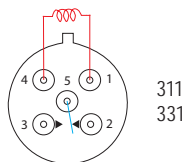
Relay Type
SPDT Non-Latching
Coil Type
311 = Standard Coil 331 = Sensitive Coil
Mounting
RF = Thru-hole GRF = Surface-Mount (Stub)
Temperature
Storage: -65°C to +125°C Operating: -55°C to +85°C



Schematics as viewed from terminals

Part No.	Nominal Coil		Typical RF Performance			
	Voltage (Vdc)	Resistance (Ω)	Frequency (GHz)	VSWR (max)	Isolation Across Contacts (dB) (min)	Insertion Loss (dB) (max)
 RF311	5	63	DC-2	1.3 : 1	25	0.2
	12	500	2-4	1.6 : 1	20	0.4
	26	2000	4-6	1.6 : 1	20	0.6
			6-8	1.6 : 1	15	0.8
 GRF311	5	63	DC-2	1.2 : 1	30	0.3
	12	500	2-4	1.5 : 1	25	0.5
	26	2000	4-6	1.5 : 1	25	0.7
			6-8	1.6 : 1	20	1.0
 RF331	5	125	DC-2	1.3 : 1	25	0.2
	12	1025	2-4	1.6 : 1	20	0.4
	26	4000	4-6	1.6 : 1	20	0.6
			6-8	1.6 : 1	15	0.8

Series RF341 Electromechanical Relays

The RF341 series relay is an ultraminiature, hermetically sealed, magnetic-latching relay featuring extremely low intercontact capacitance for exceptional RF performance well into the C band. Its low profile and small size make it ideal for applications where extreme packaging density and/or close PC board spacing are required. Due to its minimal mass, many relays may be used to configure replacements for bulkier switching solutions at substantial savings in weight. The RF341 design has been optimized by increasing the distance between the set/reset contacts. This design improvement makes these unique relays the perfect choice for use in RF attenuators, RF switching matrices and other RF applications requiring high isolation, low insertion loss and low VSWR.



The GRF341 features a unique ground shield that isolates and shields each lead to ensure excellent contact-to-contact isolation. This ground shield provides a ground interface that results in improved high-frequency performance as well as parametric repeatability.

- Excellent Signal integrity up to 10Gbps
- Hermetically Sealed
- High Resistance to ESD
- Metal Enclosure for EMI shielding
- High Repeatability
- Broader bandwidth
- Through-hole or surface-mount configurations

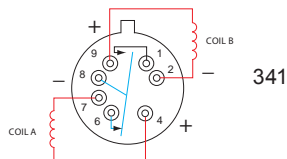
Relay Type
SPDT Magnetic-Latching
Coil Type
341 = Standard Coil
Mounting
RF = Thru-hole GRF = Surface-Mount (Stub)
Temperature
Storage: -65°C to +125°C Operating: -55°C to +85°C



SCHEMATIC
(Coil A Last Energized)

Part No.	Nominal Coil		Typical RF Performance			
	Voltage (Vdc)	Resistance (Ω)	Frequency (GHz)	VSWR (max)	Isolation Across Contacts (dB) (min)	Insertion Loss (dB) (max)
 RF341	5	61	DC-2	1.2 : 1	30	0.5
	12	500	2-4	1.2 : 1	25	0.8
	26	2000	4-6	1.4 : 1	20	2.0
 GRF341	5	61	DC-2	1.2 : 1	35	0.3
	12	500	2-4	1.3 : 1	30	0.7
	26	2000	4-6	1.4 : 1	25	1.5

Schematics as viewed from terminals

RF RELAYS

Series RF255/RF257 Electromechanical Relays

The Series RF255/257 The Series RF255 is an industry-standard, half-size, latching crystal can relay. These relays are highly suitable for high RF power applications (RF Power Handling) and other RF circuits. Teledyne Relays' Series RF255 offers: all welded construction, wire leads, gold-plated or solder-coated, matched seal for superior hermeticity, gold-plated contact assembly, modernized assembly process and advanced cleaning techniques.

- Excellent Signal integrity up to 10Gbps
- Hermetically Sealed
- High Resistance to ESD
- Metal Enclosure for EMI shielding
- High Repeatability
- Broader bandwidth
- Through-hole or surface-mount configurations

Relay Type
DPDT Magnetic-Latching
Mounting
RF = Thru-hole
Temperature
Storage: -65°C to +125°C
Operating: -55°C to +85°C

Part No.	Nominal Coil		Typical RF Performance				
	Voltage (Vdc)	Resistance (Ω)	Frequency (GHz)	VSWR (max)	Isolation (dB)		Insertion Loss (dB) (max)
					Pole to Pole (min)	Across Contacts (min)	
 RF255 RF257	5	45	DC-1	1.10:1	40	25	0.3
	6	63	1-2	1.60:1	35	20	0.6
	12	254	2-3	1.90:1	30	20	0.8
	26	1000					

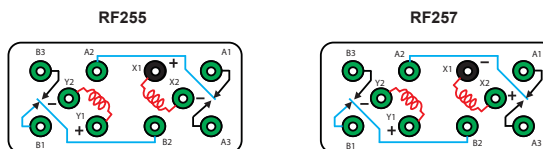

SCHEMATIC
(Coil X Last Energized)
(Bottom View)

Series GRF342 Electromechanical Relays

The Series GRF342 relay is a hermetically sealed, RF relay designed from inception for surface mount applications. This magnetic-latching relay features extremely low internal circuit losses for exceptional time and frequency domain response characteristics through and beyond the UHF spectrum and into the S band. The GRF342 features a unique ground shield that isolates and shields each lead to ensure excellent contact-to-contact and pole-to-pole isolation. This ground shield provides an RF ground interface that results in improved high-frequency performance as well as parametric repeatability. The GRF342 extends performance advantages over similar RF devices that simply offer formed leads for surface mounting.

- Excellent Signal integrity up to 10Gbps
- Hermetically Sealed
- High Resistance to ESD
- Metal Enclosure for EMI shielding
- High Repeatability
- Broader bandwidth
- Through-hole or surface-mount configurations

Relay Type
DPDT Magnetic-Latching
Coil Type
342 = Standard Coil
Mounting
GRF = Surface-Mount (Stub)
Temperature
Storage: -65°C to +125°C
Operating: -55°C to +85°C

Part No.	Nominal Coil		Typical RF Performance				
	Voltage (Vdc)	Resistance (Ω)	Frequency (GHz)	VSWR (max)	Isolation (dB)		Insertion Loss (dB) (max)
					Pole to Pole (min)	Across Contacts (min)	
 GRF342	5	61	DC-2	1.1 : 1	40	35	0.3
	12	500	2-4	1.2 : 1	30	30	0.4
			4-6	1.4 : 1	25	25	0.8

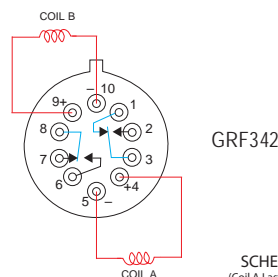

SCHEMATIC
(Coil A Last Energized)

Schematics as viewed from terminals

RF RELAYS

Series RF180 Electromechanical Relays

The Series RF180 relay is a hermetically sealed, magnetic-latching relay featuring extremely low intercontact capacitance for exceptional RF performance over the full UHF spectrum. Its low profile height and .100" (2.54 mm) grid spaced terminals make it ideal for applications where extreme packaging density and/or close PC board spacing are required.

The GRF180 features a unique ground shield that isolates and shields each lead to ensure excellent contact-to-contact and pole-to-pole isolation. This ground shield provides a ground interface that results in improved high-frequency performance as well as parametric repeatability.

- Excellent Signal integrity up to 10Gbps
- Hermetically Sealed
- High Resistance to ESD
- Metal Enclosure for EMI shielding
- High Repeatability
- Broader bandwidth
- Through-hole or surface-mount configurations

Relay Type
DPDT Magnetic-Latching
Coil Type
180 = Standard Coil
Mounting
RF = Thru-hole GRF = Surface-Mount (Stub)
Temperature
Storage: -65°C to +125°C Operating: -55°C to +85°C

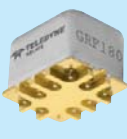
Part No.	Nominal Coil		Typical RF Performance				
	Voltage (Vdc)	Resistance (Ω)	Frequency (GHz)	VSWR (max)	Isolation (dB)		Insertion Loss (dB) (max)
					Pole to Pole (min)	Across Contacts (min)	
 RF180	5	61	DC-2	1.3 : 1	50	30	0.2
	12	500	2-4	1.3 : 1	45	30	0.3
	26	2000	4-6	2.0 : 1	30	25	1.5
 GRF180	5	61	DC-2	1.2 : 1	50	35	0.2
	12	500	2-4	1.3 : 1	35	30	0.4
	26	2000	4-6	2.0 : 1	25	30	1.5

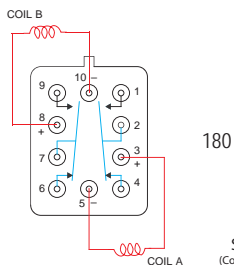

Schematics as viewed from terminals



RF RELAYS

Series RF424/GRF424/SGRF424 Electromechanical Relays

The Series RF424/GRF424/SGRF424 relay is an ultraminiature, hermetically sealed, magnetic-latching relay featuring low intercontact capacitance for exceptional RF performance from DC-8 GHz. Its low profile and small size make it ideal for applications where extreme packaging density and/or close PC board spacing are required. The RF424 Series features a unique ground shield that isolates and shields each lead to ensure excellent contact-to-contact and pole-to-pole isolation. This ground shield provides a ground interface that results in improved high-frequency performance as well as parametric repeatability.

- Excellent Signal integrity up to 12Gbps
- Hermetically Sealed
- High Resistance to ESD
- Metal Enclosure for EMI shielding
- High Repeatability
- Broader bandwidth
- Through-hole or surface-mount configurations

Relay Type
4PST Magnetic-Latching
Coil Type
424 = Standard Coil
Mounting
RF = Thru-hole GRF = Surface-Mount (Stub) SGRF = Surface-Mount (J-Lead)
Temperature
Storage: -65°C to +125°C Operating: -55°C to +85°C

Part No.	Nominal Coil		Typical RF Performance				
	Voltage (Vdc)	Resistance (Ω)	Frequency (GHz)	VSWR (max)	Isolation (dB)		Insertion Loss (dB) (max)
					Pole to Pole (min)	Across Contacts (min)	
 RF424 RF424D	5	61	DC-2	1.10:1	50	30	0.2
	12	500	2-4	1.20:1	40	20	0.3
	26	2000	4-6	1.30:1	30	15	0.4
			6-8	1.60:1	25	15	0.6
 GRF424 GRF424D	5	61	Contact Factory				
	12	500					
	26	2000					
 SGRF424 SGRF424D	5	61	Contact Factory				
	12	500					
	26	2000					

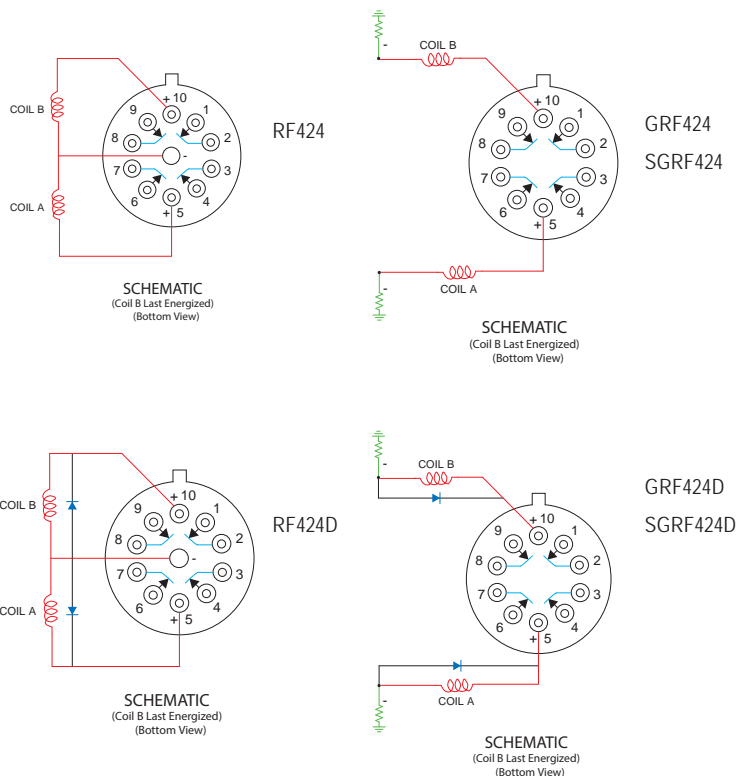

Schematics as viewed from terminals
For GRF424 and SGRF424 case to be grounded

RF RELAYS

Series RF310/RF313 Electromechanical Relays



The ultraminiature RF310 and RF313 relays are designed with an internal bypass (through path), when the coil is de-energized, to provide low insertion loss and VSWR through the bypass and simplicity of design for the user. Relays have improved RF insertion loss repeatability over the frequency range from DC to 3 GHz. Highly suitable for use in attenuator, linear amplifier and other RF circuits.

- N.C. bypass configuration
- Repeatability insertion loss
- Broad Bandwidth
- Metal Enclosure for EMI shielding
- Ground pin option to improve ground case RF grounding
- High isolation between control and signal path

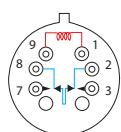
Relay Type
Normally Closed Bypass
Coil Type
310 = Standard Coil
313 = Sensitive Coil
Mounting
RF = Thru-hole
Temperature
Storage: -65°C to +125°C
Operating: -55°C to +85°C



RF310
RF313

Part No.	Nominal Coil		Frequency (GHz)	Typical RF Performance					
	Voltage (Vdc)	Resistance (Ω)		VSWR		Isolation (dB)		Insertion Loss (dB)	
				N.O. (max)	Bypass (max)	N.O. (min)	Bypass (min)	N.O. (max)	Bypass (max)
 RF310	5	50	DC-1	1.2 : 1	1.3 : 1	35	25	0.2	0.3
	12	390	1-2	1.2 : 1	1.3 : 1	25	25	0.3	0.4
			2-3	1.4 : 1	1.3 : 1	25	20	0.4	0.5
 RF313	5	100	DC-1	1.2 : 1	1.3 : 1	35	25	0.2	0.3
	12	850	1-2	1.2 : 1	1.3 : 1	25	25	0.3	0.4
			2-3	1.5 : 1	1.3 : 1	25	20	0.5	0.4

Series RF320/RF323 Electromechanical Relays



The ultraminiature RF320 and RF323 relays are designed with an internal bypass (through path), when the coil is energized, to provide low insertion loss and VSWR through the bypass and simplicity of design for the user. The RF320 and RF323 relays have improved RF insertion loss repeatability over the frequency range from DC to 3 GHz. Highly suitable for use in attenuator, linear amplifier and other RF circuits.

- N.O. bypass configuration
- Repeatability insertion loss
- Broad Bandwidth
- Metal Enclosure for EMI shielding
- Ground pin option to improve ground case RF grounding
- High isolation between control and signal path

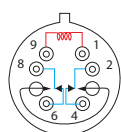
Relay Type
Normally Open Bypass
Coil Type
320 = Standard Coil
323 = Sensitive Coil
Mounting
RF = Thru-hole
Temperature
Storage: -65°C to +125°C
Operating: -55°C to +85°C



RF320
RF323

Part No.	Nominal Coil		Frequency (GHz)	Typical RF Performance					
	Voltage (Vdc)	Resistance (Ω)		VSWR		Isolation (dB)		Insertion Loss (dB)	
				N.C. (max)	Bypass (max)	N.C. (min)	Bypass (min)	N.C. (max)	Bypass (max)
 RF320	5	50	DC-1	1.2 : 1	1.4 : 1	30	25	0.2	0.4
	12	390	1-2	1.2 : 1	1.4 : 1	30	20	0.3	0.4
			2-3	1.4 : 1	1.4 : 1	25	20	0.4	0.6
 RF323	5	100	DC-1	1.2 : 1	1.4 : 1	30	25	0.2	0.4
	12	850	1-2	1.2 : 1	1.4 : 1	30	20	0.3	0.4
			2-3	1.4 : 1	1.4 : 1	25	20	0.4	0.5

Schematics as viewed from terminals

RF RELAYS

Series A150 Electromechanical Relays

The Series A150 ultraminiature Attenuator Relays are designed for attenuating RF signals in 50-ohm systems over a frequency range from DC to 3 GHz. Their low profile and small grid spacing makes them ideal for use when packaging density is a prime consideration. The A150 relays eliminate the need for additional external resistors.

These single section, switchable attenuator relays have internal matched thin film attenuator pads in "L," "T" or "Pi" configurations, as applicable. Relays are available in fixed increments of 1, 2, 3, 4, 5, 6, 8, 10, 16 and 20 dB, which can be used singly or in combination to achieve the attenuation levels desired.

The GA150 features a unique ground shield that isolates and shields each lead to ensure excellent contact-to-contact isolation. This ground shield provides a ground interface that results in improved high-frequency performance as well as parametric repeatability.

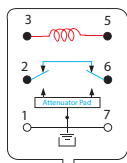

- Excellent phase linearity
- Hermetically Sealed
- High Resistance to ESD
- Metal Enclosure for EMI shielding
- High Repeatability
- Broader bandwidth
- Through-hole or surface-mount configurations

Relay Type
RF Attenuator
Coil Type
A150 = Standard Coil
Mounting
A = Thru-hole GA = Surface-Mount (Stub)
Temperature
Storage: -65°C to +125°C Operating: -55°C to +85°C



150

SCHEMATIC
(Bottom View)

Part No.	Nominal Coil		Frequency (GHz)	Typical RF Performance			
	Voltage (Vdc)	Resistance (Ω)		VSWR		Insertion Loss (dB)	
				Attenuated Path (Typ.)	Thru Path (Max.)	Typ.	Max.
 A150	5	50	DC-1	1.20 : 1	1.10 : 1	0.1	0.25
	12	390	1-2	1.30 : 1	1.20 : 1	0.2	0.35
	15	610	2-3	1.40 : 1	1.25 : 1	0.3	0.55
	26	1560					
 GA150	5	50	DC-1	1.20 : 1	1.20 : 1	0.1	0.25
	12	390	1-2	1.20 : 1	1.20 : 1	0.2	0.35
	15	610	2-3	1.20 : 1	1.30 : 1	0.3	0.45
	26	1560					

Series A152 Electromechanical Relays

The Series A152 highly repeatable ultraminiature attenuator relays are designed for attenuating RF signals in 50-ohm systems over a frequency range from DC to 5 GHz. Their low profile and small grid spacing makes them ideal for use when packaging density is a prime consideration. The A152 relays eliminate the need for additional external resistors/attenuators.

These single section, switchable attenuator relays have an internal matched thin film attenuator pad in a "Pi" configuration. Relays are available in a fixed increment of 20 dB. (Other values available)

The GA152 features a unique ground shield that isolates and shields each lead to ensure excellent contact-to-contact isolation. This ground shield provides a ground interface that results in improved high-frequency performance as well as parametric repeatability.

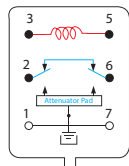

- Hermetically Sealed
- High Resistance to ESD
- Metal Enclosure for EMI shielding
- High Repeatability
- Broader bandwidth
- Through-hole or surface-mount configurations

Relay Type
RF Attenuator
Coil Type
A152 = Standard Coil
Mounting
A = Thru-hole GA = Surface-Mount (Stub)
Temperature
Storage: -65°C to +125°C Operating: -55°C to +85°C



152

SCHEMATIC
(Bottom View)

Part No.	Nominal Coil		Frequency (GHz)	Typical RF Performance			
	Voltage (Vdc)	Resistance (Ω)		VSWR		Insertion Loss (dB)	
				Attenuated Path (Typ.)	Thru Path (Max.)	Typ.	Max.
 A152	5	50	DC-1	1.20 : 1	1.10 : 1	0.1	0.25
	12	390	1-2	1.30 : 1	1.20 : 1	0.2	0.35
	15	610	2-3	1.40 : 1	1.25 : 1	0.3	0.55
	26	1560	3-5	See Datasheet			
 GA152	5	50	DC-1	1.20 : 1	1.20 : 1	0.1	0.25
	12	390	1-2	1.20 : 1	1.20 : 1	0.2	0.35
	15	610	2-3	1.20 : 1	1.30 : 1	0.3	0.45
	26	1560	3-5	1.40 : 1	1.70 : 1	0.4	0.55

COMMERCIAL RELAYS

Series 122C Electromechanical Relays

The 122C Centigrad® magnetic-latching relay is an ultraminiature, hermetically sealed, armature relay capable of being directly driven by most IC logic families. Its low profile height and .100" (2.54 mm) grid spaced terminals, which precludes the need for spreader pads, make it ideal for applications where extreme packaging density and/or close PC board spacing are required.

The basic operating function and internal structure are similar to Teledyne's TO-5, 422 relay series. The 122C is capable of meeting Teledyne Relays' T2R® requirements.

The Series 122C relay has internal silicon diodes for coil suppression, Zener diodes to protect the MOSFET gate inputs, and N-channel enhancement-mode MOSFET chips, which enable direct relay interfacing with most microprocessor and IC logic families (CMOS, TTL and MOS).

The 122C magnetic-latching relay is ideally suited for applications where coil operating power must be minimized. The relays can be operated with a short-duration pulse. After the contacts have transferred, no external coil power is required.

The magnetic-latching feature of the Series 122C relay provides a "memory" capability, since the relays will not reset upon removal of coil power.

- All welded construction
- Unique uni-frame design providing high magnetic efficiency and mechanical rigidity
- High force/mass ratio for resistance to shock and vibration
- Precious metal alloy contact material with gold plating assures excellent high current and dry circuit switching capabilities

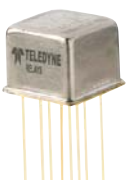
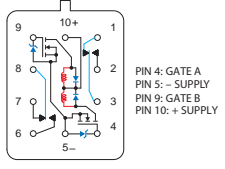
Relay Type		Part No.	Nominal Coil				Contact Load Rating	
DPDT Magnetic-Latching			Voltage (Vdc)	Coil Current (mA)		Operating Power (mW)		Latch and Reset Voltage (Vdc) (Max)
CMOS Feature				Min.	Max.			
Internal power MOSFET driver and diode coil suppression		 122C	5	82.2	114.9	505	3.5	Resistive: 1A/28Vdc Inductive: 200mA/28Vdc (320mH) Lamp: 100mA/28Vdc Low Level: 10 to 50 uA/10 to 50 mV
Vibration			6	41.6	57.0	296	4.5	
Shock			9	27.4	37.2	288	6.8	
30 g's			12	20.5	27.8	287	9.0	
100 g's 6 msec, half-sine			18	13.7	18.2	286	13.5	
26			26	11.4	15.2	351	18.0	
Acceleration		 122C						
50 g's								
Temperature								
Storage: -65°C to +125°C		SCHEMATIC (Coil A Last Energized)						
Operating: -55°C to +85°C		PIN 4: GATE A PIN 5: - SUPPLY PIN 9: GATE B PIN 10: + SUPPLY						



Series 172 Electromechanical Relays

The 172 Centigrad® relay is an ultraminiature, hermetically sealed, armature relay for commercial applications. Its low profile height .280" (7.11 mm) and .100" (2.54 mm) grid spaced terminals, which preclude the need for spreader pads, make it an ideal choice where extreme packaging density and/or close PC board spacing are required.

The Series 172 relay has an internal discrete silicon diode for coil transient suppression.

By virtue of its inherently low intercontact capacitance and contact circuit losses, the 172 relay is an excellent subminiature RF switch for frequencies well into the UHF spectrum. Applications include telecommunications, test instruments, mobile communications, attenuators, and automatic test equipment.

- All welded construction
- Unique uni-frame design providing high magnetic efficiency and mechanical rigidity
- High force/mass ratio for resistance to shock and vibration
- Precious metal alloy contact material with gold plating assures excellent high current and dry circuit switching capabilities

Relay Type		Part No.	Nominal Coil				Contact Load Rating
DPDT Non-Latching			Voltage (Vdc)	Resistance (Ω)	P.U.V (Vdc) (max.)	Operating Power (mW)	
Diode Options							
D = Internal diode for coil transient suppression		 172 172D	3	39	2.25	235	Resistive: 1A/28Vdc Inductive: 200mA/28Vdc (320mH) Lamp: 100mA/28Vdc Low Level: 10 to 50 uA/10 to 50 mV
Vibration			5	64	3.8	405	
Shock			12	400	9.0	360	
10 g's to 500 Hz			26	1600	18.0	440	
30 g's 6 msec, half-sine		 172 172D					
Temperature							
Storage: -65°C to +125°C							
Operating: -55°C to +85°C		Schematics as viewed from terminals					

Schematics as viewed from terminals

P.U.V = Pick-Up Voltage

COMMERCIAL RELAYS

Series 712 Electromechanical Relays

The TO-5 relay, originally conceived and developed by Teledyne, has become one of the industry standards for low-level switching from dry circuit to 1 ampere. Designed for high-density PC board mounting, the Series 712 relays are some of the most versatile ultraminiature relays available because of their small size and low coil power dissipation.

The Series 712D relay has an internal discrete silicon diode for coil transient suppression. The hybrid Series 712TN relay has an internal silicon diode and transistor driver. The integrated packaging of the relay with its associated semiconductor devices greatly reduces PC board floor space requirements as well as component installation costs.

By virtue of its inherently low intercontact capacitance and contact circuit losses, the 712 has proven to be excellent ultraminiature RF switch for frequency ranges well into the UHF spectrum. A typical RF application for the TO-5 relay is in handheld radio transceivers, wherein the combined features of good RF performance, small size, low coil power dissipation and high reliability make it a preferred method of Transmit-Receive switching.

- All welded construction
- Unique uni-frame design providing high magnetic efficiency and mechanical rigidity
- High force/mass ratio for resistance to shock and vibration
- Precious metal alloy contact material with gold plating assures excellent high current and dry circuit switching capabilities

Relay Type		Part No.	Nominal Coil				Contact Load Rating
DPDT Non-Latching			Voltage (Vdc)	Resistance (Ω)	P.U.V (Vdc) (max.)	Base Current to Turn On (712 TN only)	
Diode Options		 712 712D 712TN	5	50	3.6	3.00	Resistive: 1A/28Vdc Inductive: 200mA/28Vdc (320mH) Lamp: 100mA/28Vdc Low Level: 10 to 50 uA/10 to 50 mV
D = Internal diode for coil transient suppression			6	98	4.2	2.04	
TN = Internal transistor driver and coil transient suppression diode			9	220	6.5	1.36	
Vibration			12	390	8.4	1.03	
Shock			18	880	13.0	0.68	
10 g's to 500 Hz		26	1560	17.0	0.50		
Temperature							
Storage: -65°C to +125°C							
Operating: -55°C to +85°C							

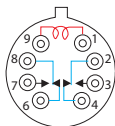

712

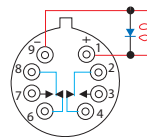

712D

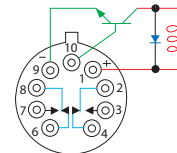

712TN

Schematics as viewed from terminals

Series 722 Electromechanical Relays

The magnetic-latching TO-5 relay, originally conceived and developed by Teledyne, has become one of the industry standards for low-level switching from dry circuit to 1 ampere. Designed for high-density PC board mounting, the 722 relay has become one of the most versatile ultraminiature relays available because of its small size and low coil power dissipation.

The Series 722D relay has discrete silicon diodes for coil transient suppression.

The Series 722 magnetic-latching relays are ideally suited for applications where coil power dissipation must be minimized. The relays can be operated with a short duration pulse and after the contacts have transferred, no external coil power is required. The magnetic-latching feature of the Series 722 provides a "memory" capability, since the relays will not reset upon removal of coil power.

- All welded construction
- Unique uni-frame design providing high magnetic efficiency and mechanical rigidity
- High force/mass ratio for resistance to shock and vibration
- Precious metal alloy contact material with gold plating assures excellent high current and dry circuit switching capabilities

Relay Type		Part No.	Nominal Coil			Contact Load Rating
DPDT Magnetic-Latching			Voltage (Vdc)	Resistance (Ω)	Set & Reset Voltage (Vdc)	
Diode Options		 722 722D	5	61	3.5	Resistive: 1A/28Vdc Inductive: 200mA/28Vdc (320mH) Lamp: 100mA/28Vdc Low Level: 10 to 50 uA/10 to 50 mV
D = Internal diode for coil transient suppression			6	120	4.5	
Vibration			9	280	6.8	
Shock			12	500	9.0	
10 g's to 500 Hz			18	1130	13.5	
		26	2000	18.0		

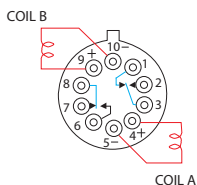

722

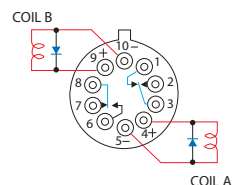

722D

SCHEMATIC
(Coil A Last Energized)
(Bottom View)

SCHEMATIC
(Coil A Last Energized)
(Bottom View)

COMMERCIAL

COMMERCIAL RELAYS

Series 732 Electromechanical Relays

The TO-5 relay, originally conceived and developed by Teledyne, has become one of the industry standards for low-level switching from dry circuit to 1 ampere. Designed for high-density PC board mounting, the Series 732 relay is one of the most versatile ultraminiature relays available because of their small size and low coil power dissipation. The sensitive 732 relay has a high resistance coil, thus requiring extremely low operating power (200 mW typical). The advantages of reduced heat dissipation and power supply demands are a plus.

The Series 732D relay has an internal discrete silicon diode for coil transient suppression. The hybrid Series 732TN relay has an internal silicon diode and transistor driver. The integrated packaging of the relay with its associated semiconductor devices greatly reduces PC board floor space requirements as well as component installation costs.

By virtue of its inherently low intercontact capacitance and contact circuit losses, the 732 has proven to be excellent ultraminiature RF switch for frequency ranges well into the UHF spectrum. A typical RF application for the TO-5 relay is in handheld radio transceivers, wherein the combined features of good RF performance, small size, low coil power dissipation and high reliability make it a preferred method of Transmit-Receive switching.

- All welded construction
- Unique uni-frame design providing high magnetic efficiency and mechanical rigidity
- High force/mass ratio for resistance to shock and vibration
- Precious metal alloy contact material with gold plating assures excellent high current and dry circuit switching capabilities

Relay Type		Part No.	Nominal Coil				Contact Load Rating	
DPDT Non-Latching Coil			Voltage (Vdc)	Resistance (Ω)	P.U.V (Vdc) (max.)	Base Current to Turn On (712 TN only)		
Diode Options			5	100	3.5	1.50	Resistive: 1A/28Vdc Inductive: 200mA/28Vdc (320mH) Lamp: 100mA/28Vdc Low Level: 10 to 50 uA/10 to 50 mV	
D = Internal diode for coil transient suppression			732	6	200	4.5		1.00
TN = Internal transistor driver and coil transient suppression diode			732D	9	400	6.8		0.75
Vibration	Shock		732TN	12	850	9.0		0.47
10 g's to 500 Hz	30 g's 6 msec, half-sine			18	1600	13.5		0.38
Temperature			26	3300	18.0	0.24		

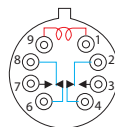

732

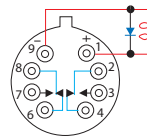

732D

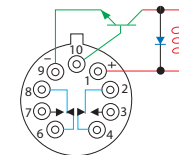

732TN

Schematics as viewed from terminals

COMMERCIAL SURFACE-MOUNT RELAYS

Series S114 & S134 Electromechanical Relays









The Series S114 Surface Mount Centigrad® Relay is an ultraminiature, hermetically sealed, armature relay. The low profile height .360" (9.14 mm) and .100" (2.54 mm) lead spacing make it ideal for applications where extreme packaging density and/or close PC board spacing are required. The specially formed leads are pre-tinned to make the relays ideal for most types of surface mount solder reflow processes.

The basic design and internal construction are identical to the Series 114 & 134 Centigrad® relays, and are capable of meeting Teledyne Relays' T2R® requirements.

The S114D and S114DD relays have internal discrete silicon diodes for coil suppression and polarity reversal protection.

The sensitive S134 surface mount Centigrad® Relay has a high resistance coil, thus requiring extremely low operating power (200 mW typical). The advantages of reduced heat dissipation and power supply demands are a plus.

- All welded construction
- Unique uni-frame design providing high magnetic efficiency and mechanical rigidity
- High force/mass ratio for resistance to shock and vibration
- Precious metal alloy contact material with gold plating assures excellent high current and dry circuit switching capabilities

Relay Type	Part No.	Nominal Coil					Contact Load Rating
		Voltage (Vdc)	Resistance (Ω)	P.U.V (Vdc) (max.)	D.O.V (Vdc)		
Coil Type					min.	max.	
DPDT Non-Latching							
S114 = Standard Coil	 S114 S114D	5	50	3.5	0.14	2.3	Resistive: 1A/28Vdc Inductive: 200mA/28Vdc (320mH) Lamp: 100mA/28Vdc Low Level: 10 to 50 uA/10 to 50 mV
S134 = Sensitive Coil		6	98	4.5	0.18	3.2	
Diode Options		9	220	6.8	0.35	4.9	
		12	390	9.0	0.41	6.5	
		18	880	13.5	0.59	10.0	
D = Internal diode for coil transient suppression DD = Internal diode for coil transient suppression and polarity reversal protection	 S114DD	26	1560	18.0	0.89	13.0	
		5	39	4.0	0.6	2.8	Resistive: 1A/28Vdc Inductive: 200mA/28Vdc (320mH) Lamp: 100mA/28Vdc Low Level: 10 to 50 uA/10 to 50 mV
		6	78	5.0	0.7	3.4	
		9	220	7.8	0.8	5.3	
12	390	10.0	0.9	6.5			
Vibration	 S114DD	18	880	14.5	1.1	10.0	
		26	1560	19.0	1.4	13.0	
Shock	 S114DD	5	100	3.5	0.12	2.5	Resistive: 1A/28Vdc Inductive: 200mA/28Vdc (320mH) Lamp: 100mA/28Vdc Low Level: 10 to 50 uA/10 to 50 mV
		6	200	4.5	0.18	3.2	
Acceleration	 S134 S134D	9	400	6.8	0.35	4.9	
		12	800	9.0	0.41	6.5	
		18	1600	13.5	0.59	10.0	
Temperature	 S134DD	26	3200	18.0	0.89	13.0	Resistive: 1A/28Vdc Inductive: 200mA/28Vdc (320mH) Lamp: 100mA/28Vdc Low Level: 10 to 50 uA/10 to 50 mV
		5	64	3.7	0.7	2.6	
		6	125	4.8	0.8	3.0	
		9	400	8.0	0.9	4.5	
Storage: -65°C to +125°C	 S134DD	12	800	11.0	1.0	5.8	
		18	1600	14.5	1.1	9.0	
Operating: -55°C to +85°C	 S134DD	26	3200	19.0	1.3	13.0	

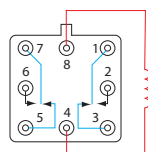

S114
S134

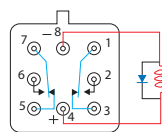

S114D
S134D

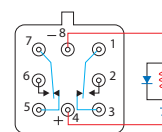

S114DD
S134DD

Schematics as viewed from terminals

COMMERCIAL SURFACE-MOUNT

COMMERCIAL SURFACE-MOUNT RELAYS

Series S172 Electromechanical Relays

The S172 surface mount Centigrad® relay is an ultraminiature, hermetically sealed, armature relay for commercial applications. Its low profile height .470" (11.94 mm) and .100" (2.54 mm) grid spaced terminals make it an ideal choice where extreme packaging density and/or close PC board spacing are required. The specially formed surface-mount leads are pre-tinned to make the relays ideal for all types of surface-mount solder reflow processes.

The basic design and internal structure are similar to Teledyne's DPDT 114 Centigrad® relay. (see page 16) The S172D relay has an internal discrete silicon diode for coil transient suppression.

- All welded construction
- Unique uni-frame design providing high magnetic efficiency and mechanical rigidity
- High force/mass ratio for resistance to shock and vibration
- Precious metal alloy contact material with gold plating assures excellent high current and dry circuit switching capabilities

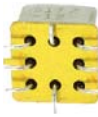
Relay Type		Part No.	Nominal Coil				Contact Load Rating
DPDT Non-Latching			Voltage (Vdc)	Resistance (Ω)	P.U.V (Vdc) (max.)	Operating Power (mW)	
Diode Options			5	64	3.8	405	Resistive: 1A/28Vdc Inductive: 200mA/28Vdc (320mH) Lamp: 100mA/28Vdc Low Level: 10 to 50 uA/10 to 50 mV
D = Internal diode for coil transient suppression			12	400	9.0	360	
Vibration			26	1600	18.0	440	
Shock							
10 g's to 500 Hz							
30 g's 6 msec, half-sine							
Temperature							
Storage: -65°C to +125°C							
Operating: -55°C to +85°C							

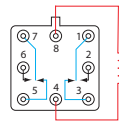

S172

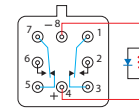

S172D

Series S422 Electromechanical Relays

The magnetic-latching TO-5 relay, originally conceived and developed by Teledyne, has become one of the industry standards for low-level switching from dry circuit to 1 ampere. Designed for high-density PC board surface mounting, its small size and low coil power dissipation make the S422 relay one of the most versatile ultraminiature relays available.

The Series S422D and S422DD utilize discrete diodes for coil suppression and polarity reversal protection.

The Series S422 magnetic-latching relays are ideally suited for applications where power dissipation must be minimized. The relays can be operated with a short duration pulse. After the contacts have transferred, no external holding power is required.

The magnetic-latching feature of the Series S422 relays provide a "memory" capability, since the relays will not reset upon removal of coil power.

- All welded construction
- Unique uni-frame design providing high magnetic efficiency and mechanical rigidity
- High force/mass ratio for resistance to shock and vibration
- Precious metal alloy contact material with gold plating assures excellent high current and dry circuit switching capabilities

Relay Type		Part No.	Nominal Coil			Contact Load Rating
DPDT Magnetic-Latching			Voltage (Vdc)	Resistance (Ω)	Set & Reset Voltage (Vdc)	
Diode Options			5	61	3.5	Resistive: 1A/28Vdc Inductive: 200mA/28Vdc (320mH) Lamp: 100mA/28Vdc Low Level: 10 to 50 uA/10 to 50 mV
D = Internal diode for coil transient suppression			6	120	4.5	
DD = Internal diode for coil transient suppression and polarity reversal protection			9	280	6.8	
Vibration			12	500	9.0	
Shock			18	1130	13.5	
10 g's to 500 Hz						
30 g's 6 msec, half-sine						
Temperature						
Storage: -65°C to +125°C						
Operating: -55°C to +85°C						

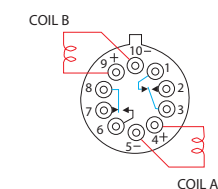

S422

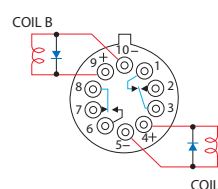

S422D

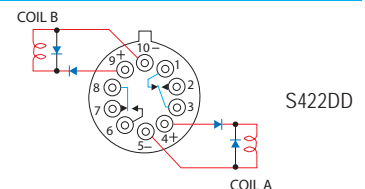

S422DD

Schematics as viewed from terminals

SCHEMATIC
(Coil A Last Energized)

SCHEMATIC
(Coil A Last Energized)

SCHEMATIC
(Coil A Last Energized)

ESTABLISHED RELIABILITY T²R RELAYS



Series ER114 Electromechanical Relays

The Series ER114 Centigrad® relay is an ultraminiature, hermetically sealed, armature relay. Its low profile height .275" (7 mm) and .100" (2.54 mm) grid spaced terminals, which precludes the need for spreader pads, make it ideal for applications where extreme packaging density and/or close PC board spacing are required. The basic design and internal construction are similar to the standard Teledyne DPDT TO-5 relay (e.g., Series ER412).

The Series ER114D and ER114DD relays have internal discrete silicon diodes for coil suppression and polarity reversal protection.

By virtue of its inherently low intercontact capacitance and contact circuit losses, the ER114 relay has proven to be an excellent ultraminiature RF switch for frequency ranges well into the UHF spectrum. A typical RF application for the ER114 relay is in handheld radio transceivers, wherein the combined features of good RF performance, small size, low coil power dissipation and high reliability make it a preferred method of Transmit-Receive switching.

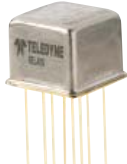
- All welded construction
- Unique uni-frame design providing high magnetic efficiency and mechanical rigidity
- High force/mass ratio for resistance to shock and vibration
- Precious metal alloy contact material with gold plating assures excellent high current and dry circuit switching capabilities

Relay Type		Part No.	Nominal Coil				Contact Load Rating	
DPDT Non-Latching			Voltage (Vdc)	Resistance (Ω)	P.U.V (Vdc) (max.)	D.O.V (Vdc)		
Diode Options						min.		max.
D = Internal diode for coil transient suppression		 ER114	5	50	3.5	0.14	2.3	Resistive: 1A/28Vdc Inductive: 200mA/28Vdc (320mH) Lamp: 100mA/28Vdc Low Level: 10 to 50 uA/10 to 50 mV
DD = Internal diode for coil transient suppression and polarity reversal protection			6	98	4.5	0.18	3.2	
Vibration			9	220	6.8	0.35	4.9	
Shock			12	390	9.0	0.41	6.5	
30 g's			18	880	13.5	0.59	10.0	
to 3000 Hz		26	1560	18.0	0.89	13.0	 ER114DD	Resistive: 1A/28Vdc Inductive: 200mA/28Vdc (320mH) Lamp: 100mA/28Vdc Low Level: 10 to 50 uA/10 to 50 mV
Acceleration		5	39	4.0	0.6	2.8		
Temperature		6	78	5.0	0.7	3.4		
50 g's		9	220	7.8	0.8	5.3		
Operating & Storage: -65°C to +125°C		12	390	10.0	0.9	6.5		
		18	880	14.5	1.1	10.0		
		26	1560	19.0	1.4	13.0		

Series ER116C Electromechanical Relays

The ER116C Centigrad® relay is an ultraminiature, hermetically sealed, armature relay capable of being directly driven by most IC logic families. Its low profile height and .100" (2.54 mm) grid spaced terminals, which preclude the need for spreader pads, make it ideal for applications where extreme packaging density and/or close PC board spacing are required.

The Series ER116C utilizes an internal silicon diode for coil suppression, a Zener diode to protect the MOSFET gate input, and an N-channel enhancement mode MOSFET chip, which enables direct relay interfacing with most Microprocessor and IC logic families (CMOS, TTL and MOS).

- All welded construction
- Unique uni-frame design providing high magnetic efficiency and mechanical rigidity
- High force/mass ratio for resistance to shock and vibration

Relay Type		Part No.	Nominal Coil				Contact Load Rating	
DPDT Non-Latching			Voltage (Vdc)	Coil Current (mA)		Operating Power (mW)		P.U.V (Vdc) (max.)
CMOS Feature				Min.	Max.			
Internal power MOSFET driver, Zener diode gate protection, and diode coil suppression		 ER116C	5	96.5	132.3	641	4.0	Resistive: 1A/28Vdc Inductive: 200mA/28Vdc (320mH) Lamp: 100mA/28Vdc Low Level: 10 to 50 uA/10 to 50 mV
Vibration			6	60.3	83.9	462	4.9	
Shock			9	33.1	47.1	368	7.3	
30 g's			12	24.9	36.1	369	9.8	
to 3000 Hz			18	16.1	24.1	368	14.6	
50 g's			26	12.9	19.9	450	19.5	

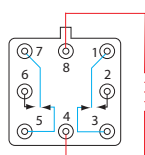

ER114

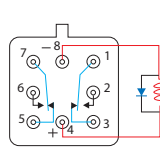

ER114D

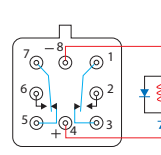

ER114DD

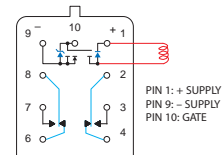

ER116C

PIN 1: + SUPPLY
PIN 9: - SUPPLY
PIN 10: GATE

P.U.V = Pick-Up Voltage

Schematics as viewed from terminals

ESTABLISHED RELIABILITY

ESTABLISHED RELIABILITY T²R RELAYS



Series ER134 Electromechanical Relays

The ER134 sensitive Centigrad® relay retains the same features as the ER114 standard Centigrad® relay with only a minimal increase in profile height .375" (9.53 mm). Its .100" (2.54 mm) grid spaced terminals, which preclude the need for spreader pads, and its low profile make the ER134 relay ideal for applications where high packaging density is important.

The Series ER134D and ER134DD have internal discrete silicon diodes for coil suppression and polarity reversal protection.

The sensitive ER134 Centigrad® relay has a high resistance coil, thus requiring extremely low operating power (200 mw typical). The advantages of reduced heat dissipation and power supply demands are a plus.

- All welded construction
- Unique uni-frame design providing high magnetic efficiency and mechanical rigidity
- High force/mass ratio for resistance to shock and vibration
- Precious metal alloy contact material with gold plating assures excellent high current and dry circuit switching capabilities

Relay Type		Part No.	Nominal Coil				Contact Load Rating	
DPDT Non-Latching			Voltage (Vdc)	Resistance (Ω)	P.U.V (Vdc) (max.)	D.O.V (Vdc)		
Diode Options						min.		max.
D = Internal diode for coil transient suppression		 ER134 ER134D	5	100	3.5	0.12	2.5	Resistive: 1A/28Vdc Inductive: 200mA/28Vdc (320mH) Lamp: 100mA/28Vdc Low Level: 10 to 50 uA/10 to 50 mV
DD = Internal diode for coil transient suppression and polarity reversal protection			6	200	4.5	0.18	3.2	
Vibration			9	400	6.8	0.35	4.9	
Shock			12	800	9.0	0.41	6.5	
30 g's to 3000 Hz			18	1600	13.5	0.59	10.0	
75 g's 6 msec, half-sine		26	3200	18.0	0.89	13.0		
Acceleration		 ER134DD	5	64	3.7	0.7	2.6	Resistive: 1A/28Vdc Inductive: 200mA/28Vdc (320mH) Lamp: 100mA/28Vdc Low Level: 10 to 50 uA/10 to 50 mV
Temperature			6	125	4.8	0.8	3.0	
50 g's			9	400	8.0	0.9	4.5	
Operating & Storage: -65°C to +125°C			12	800	11.0	1.0	5.8	
			18	1600	14.5	1.1	9.0	
		26	3200	19.0	1.3	13.0		

Series ER136C Electromechanical Relays

The sensitive ER136C Centigrad® relay is an ultraminiature, hermetically sealed, armature relay capable of being directly driven by most IC logic families. Its low profile height and .100" (2.54 mm) grid spaced terminals, which precludes the need for spreader pads, make it ideal for applications where extreme packaging density and/or close PC board spacing are required.

The sensitive ER136C Centigrad® relay has a high resistance coil, thus requiring extremely low operating power (200 mW, typical). The advantages of reduced heat dissipation and power supply demands are a plus.

The sensitive Series ER136C utilizes an internal silicon diode for coil suppression, a Zener diode to protect the MOSFET gate input, and an N-channel enhancement-mode MOSFET chip that enables direct relay interfacing with most microprocessor and IC logic families (CMOS, TTL and MOS).

- All welded construction
- Unique uni-frame design providing high magnetic efficiency and mechanical rigidity
- High force/mass ratio for resistance to shock and vibration

Relay Type		Part No.	Nominal Coil				Contact Load Rating	
DPDT Non-Latching			Voltage (Vdc)	Coil Current (mA)		Operating Power (mW)		P.U.V (Vdc) (max.)
CMOS Feature				Min.	Max.			
Internal power MOSFET driver, Zener diode gate protection, and diode coil suppression		 ER136C	5	43.0	56.0	250	4.0	Resistive: 1A/28Vdc Inductive: 200mA/28Vdc (320mH) Lamp: 100mA/28Vdc Low Level: 10 to 50 uA/10 to 50 mV
Vibration			6	27.0	33.0	180	4.9	
Shock			9	17.8	26.4	203	7.3	
30 g's to 3000 Hz			12	11.3	17.7	180	9.8	
75 g's 6 msec, half-sine			18	8.4	13.8	203	14.6	
Acceleration			26	5.8	10.2	219	19.5	
Temperature		50 g's		Operating & Storage: -65°C to +125°C				

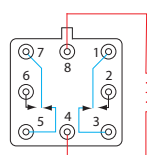

ER134

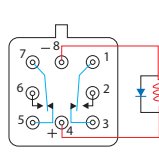

ER134D

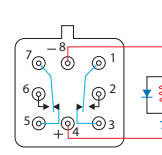

ER134DD

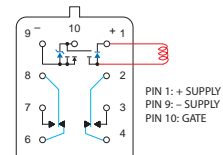

ER136C

Schematics as viewed from terminals

P.U.V = Pick-Up Voltage
D.O.V = Drop-Out Voltage

ESTABLISHED RELIABILITY T²R RELAYS

Series ER411 & ER431 Electromechanical Relays







The TO-5 relay, originally conceived and developed by Teledyne, has become one of the industry standards for low-level switching from dry circuit to 1 ampere. Designed specifically for high-density PC board mounting, its small size and low coil power dissipation make the ER411 relay one of the most versatile ultraminiature relays available.

The Series ER411D and ER411DD relays have internal discrete silicon diodes for coil suppression and polarity reversal protection. The hybrid ER411T relay features an internal silicon suppression diode and transistor driver. This hybrid package reduces required PC board floor space by reducing the number of external components needed to drive the relay.

The sensitive ER431 relay has a high resistance coil, thus requiring extremely low operating power (150 mw typical). The advantages of reduced heat dissipation and power supply demands are a plus.

The Series ER431D and ER431DD relays have internal discrete silicon diodes for coil suppression and polarity reversal protection. The hybrid ER431T relay features an internal silicon suppression diode and transistor driver. This hybrid package reduces required PC board floor space by minimizing the number of external components needed to drive the relay.

- All welded construction
- Unique uni-frame design providing high magnetic efficiency and mechanical rigidity
- High force/mass ratio for resistance to shock and vibration
- Precious metal alloy contact material with gold plating assures excellent high current and dry circuit switching capabilities

Relay Type		Part No.	Nominal Coil				Contact Load Rating	
SPDT Non-Latching			Voltage (Vdc)	Resistance (Ω)	P.U.V (Vdc) (max.)	D.O.V (Vdc)		
Coil Type						min.		max.
ER411 = Standard Coil		 ER411	5	63	3.7	0.15	2.4	Resistive: 1A/28Vdc Inductive: 200mA/28Vdc (320mH) Lamp: 100mA/28Vdc Low Level: 10 to 50 uA/10 to 50 mV
ER431 = Sensitive Coil			6	125	4.5	0.18	2.8	
Diode Options			9	280	6.8	0.35	4.2	
D = Internal diode for coil transient suppression			12	500	9.0	0.40	5.6	
DD = Internal diode for coil transient suppression and polarity reversal protection			18	1130	13.5	0.58	8.4	
T = Internal transistor drive and coil transient suppression diode		26	2000	18.0	0.89	10.4		
Vibration	Shock	 ER411DD	5	50	4.5	0.15	2.4	Resistive: 1A/28Vdc Inductive: 200mA/28Vdc (320mH) Lamp: 100mA/28Vdc Low Level: 10 to 50 uA/10 to 50 mV
30 g's to 3000 Hz	75 g's 6 msec, half-sine		6	98	5.5	0.18	2.8	
Acceleration	Temperature		9	280	7.8	0.35	4.2	
50 g's	Operating & Storage: -65°C to +125°C		12	500	10.0	0.40	5.6	
			18	1130	14.5	0.58	8.4	
		26	2000	19.0	0.89	10.4		
		 ER411T	5	63	3.9	0.15	2.4	Resistive: 1A/28Vdc Inductive: 200mA/28Vdc (320mH) Lamp: 100mA/28Vdc Low Level: 10 to 50 uA/10 to 50 mV
			6	125	5.2	0.18	2.8	
			9	280	7.8	0.35	4.2	
			12	500	10.0	0.40	5.6	
			18	1130	14.5	0.58	8.4	
		26	2000	19.0	0.89	10.4		
		 ER431	5	125	3.7	0.15	2.0	Resistive: 1A/28Vdc Inductive: 200mA/28Vdc (320mH) Lamp: 100mA/28Vdc Low Level: 10 to 50 uA/10 to 50 mV
			6	255	4.5	0.18	2.8	
			9	630	6.8	0.35	4.2	
			12	1025	9.0	0.41	5.6	
			18	2300	13.5	0.58	8.4	
		26	4000	18.0	0.89	10.4		
		 ER431DD	5	100	4.5	0.15	2.4	Resistive: 1A/28Vdc Inductive: 200mA/28Vdc (320mH) Lamp: 100mA/28Vdc Low Level: 10 to 50 uA/10 to 50 mV
			6	200	5.5	0.18	2.8	
			9	630	7.8	0.35	4.2	
			12	1025	10.0	0.40	5.6	
			18	2300	14.5	0.58	8.4	
		26	4000	19.0	0.89	10.4		
		 ER431T	5	125	3.6	0.15	2.0	Resistive: 1A/28Vdc Inductive: 200mA/28Vdc (320mH) Lamp: 100mA/28Vdc Low Level: 10 to 50 uA/10 to 50 mV
			6	255	4.8	0.18	2.8	
			9	630	7.8	0.35	4.2	
			12	1025	10.0	0.41	5.6	
			18	2300	14.5	0.58	8.4	
		26	4000	19.0	0.89	10.4		

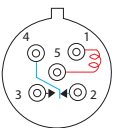

ER411
ER431

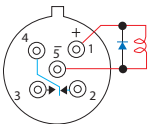

ER411D
ER431D

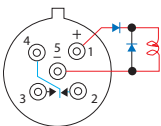

ER411DD
ER431DD

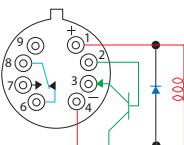

ER411T
ER431T

Schematics as viewed from terminals

P.U.V = Pick-Up Voltage
D.O.V = Drop-Out Voltage

ESTABLISHED RELIABILITY

ESTABLISHED RELIABILITY T²R RELAYS

Series ER412 & ER432 Electromechanical Relays





The TO-5 relay, originally conceived and developed by Teledyne, has become one of the industry standards for low-level switching from dry circuit to 1 ampere. Designed specifically for high-density PC board mounting, its small size and low coil power dissipation make the ER412 relay one of the most versatile ultraminiature relays available.

The Series ER412D and ER412DD relays have internal discrete silicon diodes for coil suppression and polarity reversal protection. The hybrid ER412T relay features an internal silicon suppression diode and transistor driver. This hybrid package reduces required PC board floor space by reducing the number of external components needed to drive the relay.

The sensitive ER432 relay has a high resistance coil, thus requiring extremely low operating power (200 mW typical). The advantages of reduced heat dissipation and power supply demands are a plus.

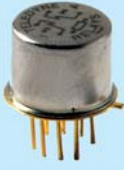
The Series ER432D and ER432DD relays have internal discrete silicon diodes for coil suppression and polarity reversal protection. The hybrid ER432T relay features an internal silicon suppression diode and transistor driver. This hybrid package reduces required PC board floor space by minimizing the number of external components needed to drive the relay.

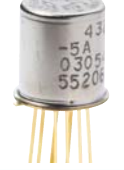
- All welded construction
- Unique uni-frame design providing high magnetic efficiency and mechanical rigidity
- High force/mass ratio for resistance to shock and vibration
- Precious metal alloy contact material with gold plating assures excellent high current and dry circuit switching capabilities

Relay Type		Part No.	Nominal Coil				Contact Load Rating	
Coil Type			Voltage (Vdc)	Resistance (Ω)	P.U.V (Vdc) (max.)	D.O.V (Vdc)		
Diode Options						min.	max.	
DPDT Non-Latching								
ER412 = Standard Coil		 ER412	5	50	3.5	0.14	2.3	Resistive: 1A/28Vdc
ER432 = Sensitive Coil			6	98	4.5	0.18	3.2	Inductive: 200mA/28Vdc (320mH)
			9	220	6.8	0.35	4.9	Lamp: 100mA/28Vdc
			12	390	9.0	0.41	6.5	Low Level: 10 to 50 uA/10 to 50 uA
			18	880	13.5	0.59	10.0	
		26	1560	18.0	0.89	13.0		
		 ER412DD	5	39	3.9	0.6	2.8	Resistive: 1A/28Vdc
			6	78	5.2	0.7	3.4	Inductive: 200mA/28Vdc (320mH)
			9	220	7.8	0.8	5.3	Lamp: 100mA/28Vdc
			12	390	10.0	0.9	6.5	Low Level: 10 to 50 uA/10 to 50 uA
			18	880	14.5	1.1	10.0	
		26	1560	19.0	1.4	13.0		
		 ER412T	5	50	3.5	0.14	2.3	Resistive: 1A/28Vdc
			6	98	4.5	0.18	3.2	Inductive: 200mA/28Vdc (320mH)
			9	220	6.8	0.35	4.9	Lamp: 100mA/28Vdc
			12	390	9.0	0.41	6.5	Low Level: 10 to 50 uA/10 to 50 mV
			18	880	13.5	0.59	10.0	
		26	1560	18.0	0.89	13.0		
		 ER432	5	100	3.5	0.14	2.5	Resistive: 1A/28Vdc
			6	200	4.5	0.18	3.2	Inductive: 200mA/28Vdc (320mH)
			9	400	6.8	0.35	4.9	Lamp: 100mA/28Vdc
			12	850	9.0	0.41	6.5	Low Level: 10 to 50 uA/10 to 50 mV
			18	1600	13.5	0.59	10.0	
		26	3300	18.0	0.89	13.0		
		 ER432DD	5	64	3.7	0.7	2.6	Resistive: 1A/28Vdc
			6	125	4.8	0.8	3.0	Inductive: 200mA/28Vdc (320mH)
			9	400	8.0	0.9	4.5	Lamp: 100mA/28Vdc
			12	850	11.0	1.0	5.8	Low Level: 10 to 50 uA/10 to 50 mV
			18	1600	14.5	1.1	9.0	
		26	3300	19.0	1.3	13.0		
		 ER432T	5	100	3.6	0.14	2.5	Resistive: 1A/28Vdc
			6	200	4.8	0.18	3.2	Inductive: 200mA/28Vdc (320mH)
			9	400	7.8	0.35	4.9	Lamp: 100mA/28Vdc
			12	850	11.0	0.41	6.5	Low Level: 10 to 50 uA/10 to 50 mV
			18	1600	14.5	0.59	10.0	
		26	3300	19.0	0.89	13.0		

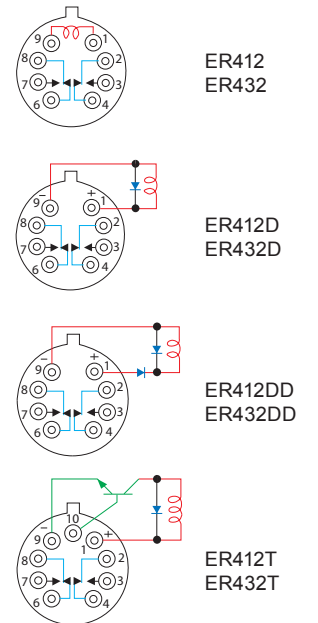

Schematics as viewed from terminals

P.U.V = Pick-Up Voltage
D.O.V = Drop-Out Voltage

ESTABLISHED RELIABILITY

ESTABLISHED RELIABILITY T²R RELAYS

Series 255, 257 Electromechanical Relays

The Series 255 is an industry-standard, half-size, latching crystal can relay. It has a wide range of switching capabilities ranging from low level to 2 amps. The Series J255/255 latching relay configuration is double-pole double-throw (DPDT), so the relay offers excellent switching density and versatility.

Half-Size Crystal Can Features:

- Low level to 2 amps
- Wide range of switching capabilities
- Smallest relay package capable of switching 2 amps
- Modernized assembly process
- Lead-free (gold-plated wire lead only)

- All welded construction
- Wire leads, gold-plated or solder-coated
- Matched seal for superior hermeticity
- Gold-plated contact assembly
- Modernized assembly process
- Advanced cleaning techniques

Relay Type	Part No.	Nominal Coil				Contact Load Rating	
		Voltage (Vdc)	Resistance (Ω)	Set & Reset Voltage			
				Min.	Max.		
DPDT Magnetic-Latching							
Vibration							
30G, 10-2500 Hz (Sinusoidal)		5	45	1.0	3.8	Resistive: 2A/28Vdc	
Shock							
100G, 6 msec half-sine (Specified Pulse)		255	6	63	1.3	4.5	Inductive: 0.75A/28Vdc (320mH)
Temperature		256	12	254	2.6	9.0	Intermediate Current: 0.1A/28Vdc
Operating & Storage: -65°C to +125°C	257	26	1000	5.2	18.0	Lamp: 0.16A/28Vdc Low Level: 10 to 50 uA/10 to 50 mV	

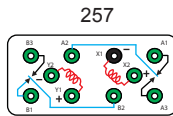

SCHEMATIC
(Coil X Last Energized)
(Bottom View)

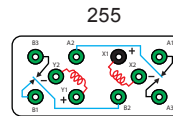

SCHEMATIC
(Coil X Last Energized)
(Bottom View)



Series ER421 Electromechanical Relays

The magnetic-latching TO-5 relay, originally conceived and developed by Teledyne, has become one of the industry standards for low-level switching from dry circuit to 1 ampere. Designed for high-density PC board mounting, its small size and low coil power dissipation make the ER421 relay one of the most versatile ultraminiature relays available.

The Series ER421D and ER421DD utilize discrete silicon diodes for coil suppression and polarity reversal protection.

The Series ER421 magnetic-latching relays are ideally suited for applications where coil power dissipation must be minimized. The relays can be operated with a short duration pulse. After the contacts have transferred, no external holding power is required. The magnetic-latching feature of the Series ER421 provides a "memory" capability, since the relays will not reset upon removal of coil power.

- All welded construction
- Unique uni-frame design providing high magnetic efficiency and mechanical rigidity
- High force/mass ratio for resistance to shock and vibration
- Precious metal alloy contact material with gold plating assures excellent high current and dry circuit switching capabilities

Relay Type	Part No.	Nominal Coil			Contact Load Rating
		Voltage (Vdc)	Resistance (Ω)	Set & Reset Voltage (Vdc)	
SPDT Magnetic-Latching					
Diode Options					
D = Internal diode for coil transient suppression		5	61	3.5	Resistive: 1A/28Vdc
DD = Internal diode for coil transient suppression and polarity reversal protection		6	120	4.5	Inductive: 200mA/28Vdc (320mH)
Vibration		9	280	6.8	Lamp: 100mA/28Vdc
Shock		12	500	9.0	Low Level: 10 to 50 uA/10 to 50 mV
30 g's to 3000 Hz		18	1130	13.5	
Acceleration		5	61	3.7	Resistive: 1A/28Vdc
Temperature		6	120	4.5	Inductive: 200mA/28Vdc (320mH)
50 g's		9	280	6.8	Lamp: 100mA/28Vdc
Operating & Storage: -65°C to +125°C		12	500	9.0	Low Level: 10 to 50 uA/10 to 50 mV
		18	1130	13.5	
		5	48	4.5	Resistive: 1A/28Vdc
		6	97	5.5	Inductive: 200mA/28Vdc (320mH)
		9	280	7.8	Lamp: 100mA/28Vdc
		12	500	10.0	Low Level: 10 to 50 uA/10 to 50 mV
		18	1130	14.5	
		26	2000	19.0	

*See Schematics on Page 21

ESTABLISHED RELIABILITY

ESTABLISHED RELIABILITY T²R RELAYS

Series ER420 & ER422 Electromechanical Relays

The magnetic-latching TO-5 relay, originally conceived and developed by Teledyne, has become one of the industry standards for low-level switching from dry circuit to 1 ampere. Designed for high-density PC board mounting, its small size and low coil power dissipation make the ER420 & ER422 relays some of the most versatile ultraminiature relays available.

The Series ER420D/ER422D and ER420DD/ER422DD utilize discrete silicon diodes for coil suppression and polarity reversal protection.

The Series ER420/ER422 magnetic-latching relays are ideally suited for applications where coil power dissipation must be minimized. The relays can be operated with a short duration pulse. After the contacts have transferred, no external holding power is required. The magnetic-latching feature of the Series ER420/ER422 relays provide a "memory" capability, since the relays will not reset upon removal of coil power.

- All welded construction
- Unique uni-frame design providing high magnetic efficiency and mechanical rigidity
- High force/mass ratio for resistance to shock and vibration
- Precious metal alloy contact material with gold plating assures excellent high current and dry circuit switching capabilities

Relay Type	Part No.	Nominal Coil			Contact Load Rating
		Voltage (Vdc)	Resistance (Ω)	Set & Reset Voltage (Vdc)	
DPDT Magnetic-Latching					
Grounding Options					
420 = Common					
422 = Individual					
Diode Options					
D = Internal diode for coil transient suppression					
DD = Internal diode for coil transient suppression and polarity reversal protection					
Vibration					
30 g's to 3000 Hz					
Shock					
100 g's 6 msec, half-sine					
Acceleration					
50 g's					
Temperature					
Operating & Storage: -65°C to +125°C					

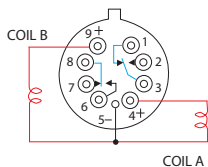

ER420

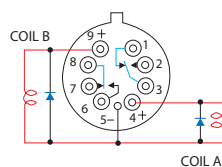

ER420D

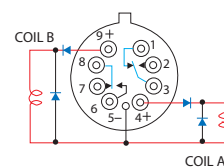

ER420DD

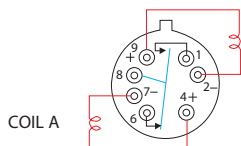

ER421

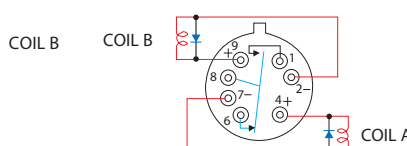

ER421D

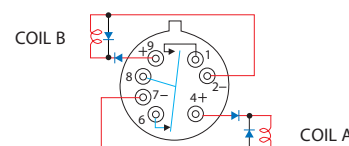

ER421DD

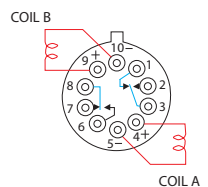

ER422

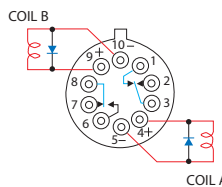

ER422D

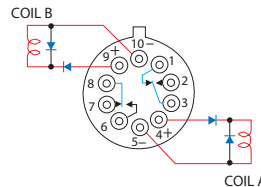

ER422DD

Schematics Shown with Coil A Last Energized
Schematics as viewed from terminals

MILITARY QUALIFIED (JAN) RELAYS



Series J114 Electromechanical Relays

The Series J114 Centigrad® relay is an ultraminiature, hermetically sealed, armature relay. Its low profile height .275" (7 mm) and .100" (2.54 mm) grid spaced terminals, which precludes the need for spreader pads, make it ideal for applications where extreme packaging density and/or close PC board spacing are required. The basic design and internal construction are similar to the standard Teledyne DPDT TO-5 relay (e.g., Series J412).

The Series J114D and J114DD relays have internal discrete silicon diodes for coil suppression and polarity reversal protection.

By virtue of its inherently low intercontact capacitance and contact circuit losses, the J114 relay has proven to be an excellent ultraminiature RF switch for frequency ranges well into the UHF spectrum. A typical RF application for the J114 relay is in handheld radio transceivers, wherein the combined features of good RF performance, small size, low coil power dissipation and high reliability make it a preferred method of Transmit-Receive switching.

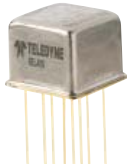
- All welded construction
- Unique uni-frame design providing high magnetic efficiency and mechanical rigidity
- High force/mass ratio for resistance to shock and vibration
- Precious metal alloy contact material with gold plating assures excellent high current and dry circuit switching capabilities

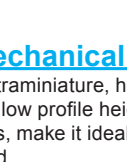
Relay Type		Part No.	Nominal Coil				Contact Load Rating	
DPDT Non-Latching			Voltage (Vdc)	Resistance (Ω)	P.U.V (Vdc) (max.)	D.O.V (Vdc)		
Diode Options						min.	max.	
D = Internal diode for coil transient suppression		 J114 (M39016/17)	5	50	3.5	0.14	2.3	Resistive: 1A/28Vdc Inductive: 200mA/28Vdc (320mH) Lamp: 100mA/28Vdc
DD = Internal diode for coil transient suppression and polarity reversal protection			6	98	4.5	0.18	3.2	
		 J114D (M39016/18)	9	220	6.8	0.35	4.9	Low Level: 10 to 50 uA/10 to 50 mV
Vibration			12	390	9.0	0.41	6.5	
Shock			18	880	13.5	0.59	10.0	
			26	1560	18.0	0.89	13.0	
		 J114DD (M39016/18)	5	39	4.0	0.6	2.8	Resistive: 1A/28Vdc Inductive: 200mA/28Vdc (320mH) Lamp: 100mA/28Vdc Low Level: 10 to 50 uA/10 to 50 mV
			6	78	5.0	0.7	3.4	
Acceleration			9	220	7.8	0.8	5.3	
Temperature			12	390	10.0	0.9	6.5	
			18	880	14.5	1.1	10.0	
			26	1560	19.0	1.4	13.0	

Series J116C Electromechanical Relays

The J116C Centigrad® relay is an ultraminiature, hermetically sealed, armature relay capable of being directly driven by most IC logic families. Its low profile height and .100" (2.54 mm) grid spaced terminals, which preclude the need for spreader pads, make it ideal for applications where extreme packaging density and/or close PC board spacing are required.

The Series J116C utilizes an internal silicon diode for coil suppression, a Zener diode to protect the MOSFET gate input, and an N-channel enhancement mode MOSFET chip, which enables direct relay interfacing with most Microprocessor and IC logic families (CMOS, TTL and MOS).

- All welded construction
- Unique uni-frame design providing high magnetic efficiency and mechanical rigidity
- High force/mass ratio for resistance to shock and vibration

Relay Type		Part No.	Nominal Coil				Contact Load Rating	
DPDT Non-Latching			Voltage (Vdc)	Coil Current (mA)		Operating Power (mW)		P.U.V (Vdc) (max.)
CMOS Feature		Min.		Max.				
Internal power MOSFET driver, Zener diode gate protection, and diode coil suppression		 J116C (M28776/6)	5	96.5	132.3	641	4.0	Resistive: 1A/28Vdc Inductive: 200mA/28Vdc (320mH) Lamp: 100mA/28Vdc Low Level: 10 to 50 uA/10 to 50 mV
Vibration			6	60.3	83.9	462	4.9	
Shock			9	33.1	47.1	368	7.3	
			12	24.9	36.1	369	9.8	
			18	16.1	24.1	368	14.6	
			26	12.9	19.9	450	19.5	

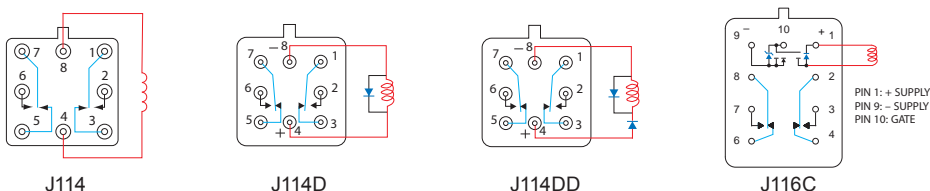

P.U.V = Pick-Up Voltage
D.O.V = Drop-Out Voltage

Schematics as viewed from terminals

MILITARY QUALIFIED (JAN) RELAYS



Series J134 Electromechanical Relays

The J134 sensitive Centigrad® relay retains the same features as the J114 standard Centigrad® relay with only a minimal increase in profile height .375" (9.53 mm). Its .100" (2.54 mm) grid spaced terminals, which preclude the need for spreader pads, and its low profile make the J134 relay ideal for applications where high packaging density is important.

The Series J134D and J134DD have internal discrete silicon diodes for coil suppression and polarity reversal protection.

The sensitive J134 Centigrad® relay has a high resistance coil, thus requiring extremely low operating power (200 mw typical). The advantages of reduced heat dissipation and power supply demands are a plus.

- All welded construction
- Unique uni-frame design providing high magnetic efficiency and mechanical rigidity
- High force/mass ratio for resistance to shock and vibration
- Precious metal alloy contact material with gold plating assures excellent high current and dry circuit switching capabilities

Relay Type		Part No.	Nominal Coil				Contact Load Rating	
Diode Options			Voltage (Vdc)	Resistance (Ω)	P.U.V (Vdc) (max.)	D.O.V (Vdc)		
						min.	max.	
DPDT Non-Latching		 J134 (M39016/41)	5	100	3.5	0.12	2.5	Resistive: 1A/28Vdc Inductive: 200mA/28Vdc (320mH) Lamp: 100mA/28Vdc Low Level: 10 to 50 uA/10 to 50 mV
D = Internal diode for coil transient suppression			6	200	4.5	0.18	3.2	
DD = Internal diode for coil transient suppression and polarity reversal protection			9	400	6.8	0.35	4.9	
Vibration			12	800	9.0	0.41	6.5	
Shock			18	1600	13.5	0.59	10.0	
Temperature			26	3200	18.0	0.89	13.0	
30 g's to 3000 Hz		 J134DD (M39016/43)	5	64	3.7	0.7	2.6	Resistive: 1A/28Vdc Inductive: 200mA/28Vdc (320mH) Lamp: 100mA/28Vdc Low Level: 10 to 50 uA/10 to 50 mV
75 g's 6 msec, half-sine			6	125	4.8	0.8	3.0	
Acceleration			9	400	8.0	0.9	4.5	
Temperature			12	800	11.0	1.0	5.8	
Operating & Storage: -65°C to +125°C			18	1600	14.5	1.1	9.0	
50 g's			26	3200	19.0	1.3	13.0	

Series J136C Electromechanical Relays

The sensitive J136C Centigrad® relay is an ultraminiature, hermetically sealed, armature relay capable of being directly driven by most IC logic families. Its low profile height and .100" (2.54 mm) grid spaced terminals, which precludes the need for spreader pads, make it ideal for applications where extreme packaging density and/or close PC board spacing are required.

The sensitive J136C Centigrad® relay has a high resistance coil, thus requiring extremely low operating power (200 mW, typical). The advantages of reduced heat dissipation and power supply demands are a plus.

The sensitive Series J136C utilizes an internal silicon diode for coil suppression, a Zener diode to protect the MOSFET gate input, and an N-channel enhancement-mode MOSFET chip that enables direct relay interfacing with most microprocessor and IC logic families (CMOS, TTL and MOS).

- All welded construction
- Unique uni-frame design providing high magnetic efficiency and mechanical rigidity
- High force/mass ratio for resistance to shock and vibration
- Precious metal alloy contact material with gold plating assures excellent high current and dry circuit switching capabilities

Relay Type		Part No.	Nominal Coil				Contact Load Rating	
CMOS Feature			Voltage (Vdc)	Coil Current (mA)		Operating Power (mW)		P.U.V (Vdc) (max.)
		Min.		Max.				
DPDT Non-Latching		 J136C (M28776/7)	5	43.0	56.0	250	4.0	Resistive: 1A/28Vdc Inductive: 200mA/28Vdc (320mH) Lamp: 100mA/28Vdc Low Level: 10 to 50 uA/10 to 50 mV
Internal power MOSFET driver, Zener diode gate protection, and diode coil suppression			6	27.0	33.0	180	4.9	
Vibration			9	17.8	26.4	203	7.3	
Shock			12	11.3	17.7	180	9.8	
Temperature			18	8.4	13.8	203	14.6	
Operating & Storage: -65°C to +125°C			26	5.8	10.2	219	19.5	

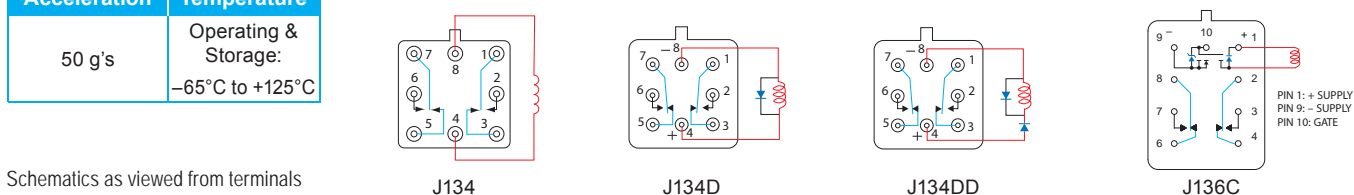

P.U.V = Pick-Up Voltage
D.O.V = Drop-Out Voltage

MILITARY QUALIFIED (JAN) RELAYS

Series J411 & J431 Electromechanical Relays









The TO-5 relay, originally conceived and developed by Teledyne, has become one of the industry standards for low-level switching from dry circuit to 1 ampere. Designed specifically for high-density PC board mounting, its small size and low coil power dissipation make the J411 relay one of the most versatile ultraminiature relays available.

The Series J411D and J411DD relays have internal discrete silicon diodes for coil suppression and polarity reversal protection. The hybrid J411T relay features an internal silicon suppression diode and transistor driver. This hybrid package reduces required PC board floor space by reducing the number of external components needed to drive the relay.

The sensitive J431 relay has a high resistance coil, thus requiring extremely low operating power (150 mw typical). The advantages of reduced heat dissipation and power supply demands are a plus.

The Series J431D and J431DD relays have internal discrete silicon diodes for coil suppression and polarity reversal protection. The hybrid J431T relay features an internal silicon suppression diode and transistor driver. This hybrid package reduces required PC board floor space by reducing the number of external components needed to drive the relay.

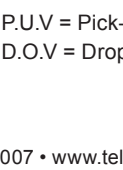
- All welded construction
- Unique uni-frame design providing high magnetic efficiency and mechanical rigidity
- High force/mass ratio for resistance to shock and vibration
- Precious metal alloy contact material with gold plating assures excellent high current and dry circuit switching capabilities

Relay Type		Part No.	Nominal Coil				Contact Load Rating	
SPDT Non-Latching			Voltage (Vdc)	Resistance (Ω)	P.U.V (Vdc) (max.)	D.O.V (Vdc)		
Coil Type		min.				max.		
J411 = Standard Coil		 J411 (M39016/7)	5	63	3.7	0.15	2.4	Resistive: 1A/28Vdc Inductive: 200mA/28Vdc (320mH) Lamp: 100mA/28Vdc Low Level: 10 to 50 uA/10 to 50 mV
J431 = Sensitive Coil			6	125	4.5	0.18	2.8	
Diode Options			9	280	6.8	0.35	4.2	
D = Internal diode for coil transient suppression		 J411D (M39016/23)	12	500	9.0	0.40	5.6	Resistive: 1A/28Vdc Inductive: 200mA/28Vdc (320mH) Lamp: 100mA/28Vdc Low Level: 10 to 50 uA/10 to 50 mV
DD = Internal diode for coil transient suppression and polarity reversal protection			18	1130	13.5	0.58	8.4	
T = Internal transistor drive and coil transient suppression diode			26	2000	18.0	0.89	10.4	
Vibration			5	50	4.5	0.15	2.4	
Shock		 J411DD (M39016/24)	6	98	5.5	0.18	2.8	Resistive: 1A/28Vdc Inductive: 200mA/28Vdc (320mH) Lamp: 100mA/28Vdc Low Level: 10 to 50 uA/10 to 50 mV
30 g's to 3000 Hz			9	280	7.8	0.35	4.2	
75 g's 6 msec, half-sine			12	500	10.0	0.40	5.6	
Acceleration			18	1130	14.5	0.58	8.4	
Temperature		 J411T (M28776/5)	26	2000	19.0	0.89	10.4	Resistive: 1A/28Vdc Inductive: 200mA/28Vdc (320mH) Lamp: 100mA/28Vdc Low Level: 10 to 50 uA/10 to 50 mV
50 g's			5	63	3.9	0.15	2.4	
Operating & Storage: -65°C to +125°C			6	125	5.2	0.18	2.8	
			9	280	7.8	0.35	4.2	
		 J431 (M39016/10)	12	500	10.0	0.40	5.6	Resistive: 1A/28Vdc Inductive: 200mA/28Vdc (320mH) Lamp: 100mA/28Vdc Low Level: 10 to 50 uA/10 to 50 mV
			18	1130	14.5	0.58	8.4	
			26	2000	19.0	0.89	10.4	
			5	100	4.5	0.15	2.4	
		 J431DD (M39016/26)	6	255	4.5	0.18	2.8	Resistive: 1A/28Vdc Inductive: 200mA/28Vdc (320mH) Lamp: 100mA/28Vdc Low Level: 10 to 50 uA/10 to 50 mV
			9	630	6.8	0.35	4.2	
			12	1025	9.0	0.41	5.6	
			18	2300	13.5	0.58	8.4	
		 J431T (M28776/4)	26	4000	18.0	0.89	10.4	Resistive: 1A/28Vdc Inductive: 200mA/28Vdc (320mH) Lamp: 100mA/28Vdc Low Level: 10 to 50 uA/10 to 50 mV
			5	125	3.6	0.15	2.0	
			6	255	4.8	0.18	2.8	
			9	630	7.8	0.35	4.2	
		 J431T (M28776/4)	12	1025	10.0	0.41	5.6	Resistive: 1A/28Vdc Inductive: 200mA/28Vdc (320mH) Lamp: 100mA/28Vdc Low Level: 10 to 50 uA/10 to 50 mV
			18	2300	14.5	0.58	8.4	
			26	4000	19.0	0.89	10.4	

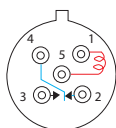

J411
J431

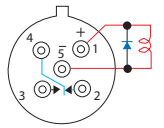

J411D
J431D

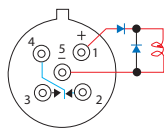

J411DD
J431DD

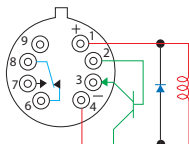

J411T
J431T

P.U.V = Pick-Up Voltage
D.O.V = Drop-Out Voltage

Schematics as viewed from terminals

MILITARY QUALIFIED (JAN)

MILITARY QUALIFIED (JAN) RELAYS

Series J412 & J432 Electromechanical Relays







The TO-5 relay, originally conceived and developed by Teledyne, has become one of the industry standards for low-level switching from dry circuit to 1 ampere. Designed specifically for high-density PC board mounting, its small size and low coil power dissipation make the J412 relay one of the most versatile ultraminiature relays available.

The Series J412D and J412DD relays have internal discrete silicon diodes for coil suppression and polarity reversal protection. The hybrid J412T relay features an internal silicon suppression diode and transistor driver. This hybrid package reduces required PC board floor space by reducing the number of external components needed to drive the relay.

The sensitive J432 relay has a high resistance coil, thus requiring extremely low operating power (200 mw typical). The advantages of reduced heat dissipation and power supply demands are a plus.

The Series J432D and J432DD relays have internal discrete silicon diodes for coil suppression and polarity reversal protection. The hybrid J432T relay features an internal silicon suppression diode and transistor driver. This hybrid package reduces required PC board floor space by reducing the number of external components needed to drive the relay.

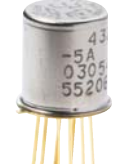
- All welded construction
- Unique uni-frame design providing high magnetic efficiency and mechanical rigidity
- High force/mass ratio for resistance to shock and vibration
- Precious metal alloy contact material with gold plating assures excellent high current and dry circuit switching capabilities

Relay Type		Part No.	Nominal Coil				Contact Load Rating	
Coil Type			Voltage (Vdc)	Resistance (Ω)	P.U.V (Vdc) (max.)	D.O.V (Vdc)		
Diode Options								
Vibration								
Shock								
Acceleration								
Temperature								
DPDT Non-Latching J412 = Standard Coil J432 = Sensitive Coil		 J412 (M39016/9)	5	50	3.5	0.14	2.3	Resistive: 1A/28Vdc Inductive: 200mA/28Vdc (320mH) Lamp: 100mA/28Vdc Low Level: 10 to 50 uA/10 to 50 uA
D = Internal diode for coil transient suppression DD = Internal diode for coil transient suppression and polarity reversal protection T = Internal transistor drive and coil transient suppression diode			6	98	4.5	0.18	3.2	
			9	220	6.8	0.35	4.9	
			12	390	9.0	0.41	6.5	
			18	880	13.5	0.59	10.0	
		26	1560	18.0	0.89	13.0		
		 J412DD (M39016/20)	5	39	3.9	0.6	2.8	Resistive: 1A/28Vdc Inductive: 200mA/28Vdc (320mH) Lamp: 100mA/28Vdc Low Level: 10 to 50 uA/10 to 50 uA
			6	78	5.2	0.7	3.4	
			9	220	7.8	0.8	5.3	
			12	390	10.0	0.9	6.5	
			18	880	14.5	1.1	10.0	
		26	1560	19.0	1.4	13.0		
		 J412T (M28776/1)	5	50	3.5	0.14	2.3	Resistive: 1A/28Vdc Inductive: 200mA/28Vdc (320mH) Lamp: 100mA/28Vdc Low Level: 10 to 50 uA/10 to 50 mV
			6	98	4.5	0.18	3.2	
			9	220	6.8	0.35	4.9	
			12	390	9.0	0.41	6.5	
			18	880	13.5	0.59	10.0	
		26	1560	18.0	0.89	13.0		
		 J432 (M39016/11)	5	100	3.5	0.14	2.5	Resistive: 1A/28Vdc Inductive: 200mA/28Vdc (320mH) Lamp: 100mA/28Vdc Low Level: 10 to 50 uA/10 to 50 mV
			6	200	4.5	0.18	3.2	
			9	400	6.8	0.35	4.9	
			12	850	9.0	0.41	6.5	
			18	1600	13.5	0.59	10.0	
		26	3300	18.0	0.89	13.0		
		 J432DD (M39016/21)	5	64	3.7	0.7	2.6	Resistive: 1A/28Vdc Inductive: 200mA/28Vdc (320mH) Lamp: 100mA/28Vdc Low Level: 10 to 50 uA/10 to 50 mV
			6	125	4.8	0.8	3.0	
			9	400	8.0	0.9	4.5	
			12	850	11.0	1.0	5.8	
			18	1600	14.5	1.1	9.0	
		26	3300	19.0	1.3	13.0		
		 J432T (M28776/3)	5	100	3.6	0.14	2.5	Resistive: 1A/28Vdc Inductive: 200mA/28Vdc (320mH) Lamp: 100mA/28Vdc Low Level: 10 to 50 uA/10 to 50 mV
			6	200	4.8	0.18	3.2	
			9	400	7.8	0.35	4.9	
			12	850	11.0	0.41	6.5	
			18	1600	14.5	0.59	10.0	
		26	3300	19.0	0.89	13.0		

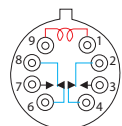

J412
J432

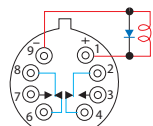

J412D
J432D

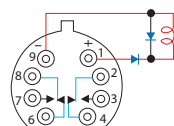

J412DD
J432DD

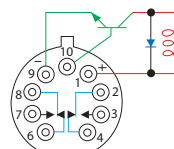

J412T
J432T

Schematics as viewed from terminals

P.U.V = Pick-Up Voltage
D.O.V = Drop-Out Voltage

MILITARY QUALIFIED (JAN)

MILITARY QUALIFIED (JAN) RELAYS

Series J255 Electromechanical Relays

The Series J255 is an industry-standard, half-size, latching crystal can relay. It has a wide range of switching capabilities ranging from low level to 2 amps. The Series J255 latching relay configuration is double-pole double-throw (DPDT), so the relay offers excellent switching density and versatility.

Half-Size Crystal Can Features:

- Low level to 2 amps
- Wide range of switching capabilities
- Smallest relay package capable of switching 2 amps
- Modernized assembly process
- Qualified to MIL-PRF39016/45
- Lead-free (gold-plated wire lead only)

- All welded construction
- Wire leads, gold-plated or solder-coated
- Matched seal for superior hermeticity
- Gold-plated contact assembly
- Modernized assembly process
- Advanced cleaning techniques

Relay Type	Part No.	Nominal Coil			Contact Load Rating	
		Voltage (Vdc)	Resistance (Ω)	Set & Reset Voltage		
				Min.		Max.
DPDT Magnetic-Latching	 J255 (M39016/45)	5	45	1.0	3.8	Resistive: 2A/28Vdc
Vibration		6	63	1.3	4.5	Inductive: 0.75A/28Vdc (320mH)
30G, 10-2500 Hz (Sinusoidal)		12	254	2.6	9.0	Intermediate Current: 0.1A/28Vdc
Shock		26	1000	5.2	18.0	Lamp: 0.16A/28Vdc
100G, 6 msec half-sine (Specified Pulse)						Low Level: 10 to 50 uA/10 to 50 mV
Temperature						
Operating & Storage: -65°C to +125°C						

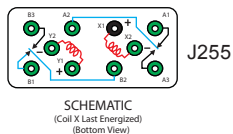



Series J421 Electromechanical Relays

The magnetic-latching TO-5 relay, originally conceived and developed by Teledyne, has become one of the industry standards for low-level switching from dry circuit to 1 ampere. Designed for high-density PC board mounting, its small size and low coil power dissipation make the J421 relay one of the most versatile ultraminiature relays available.

The Series J421D and J421DD utilize discrete silicon diodes for coil suppression and polarity reversal protection.

The Series J421 magnetic-latching relays are ideally suited for applications where coil power dissipation must be minimized. The relays can be operated with a short duration pulse. After the contacts have transferred, no external holding power is required. The magnetic-latching feature of the Series J421 provides a "memory" capability, since the relays will not reset upon removal of coil power.

- All welded construction
- Unique uni-frame design providing high magnetic efficiency and mechanical rigidity
- High force/mass ratio for resistance to shock and vibration
- Precious metal alloy contact material with gold plating assures excellent high current and dry circuit switching capabilities

Relay Type	Part No.	Nominal Coil			Contact Load Rating
		Voltage (Vdc)	Resistance (Ω)	Set & Reset Voltage (Vdc)	
SPDT Magnetic-Latching	 J421 (M39016/8)	5	61	3.5	Resistive: 1A/28Vdc
Diode Options		6	120	4.5	Inductive: 200mA/28Vdc (320mH)
D = Internal diode for coil transient suppression		9	280	6.8	Lamp: 100mA/28Vdc
DD = Internal diode for coil transient suppression and polarity reversal protection		12	500	9.0	Low Level: 10 to 50 uA/10 to 50 mV
Vibration		18	1130	13.5	
Shock	26	2000	18.0		
30 g's	 J421D (M39016/27)	5	61	3.7	Resistive: 1A/28Vdc
100 g's 6 msec, half-sine		6	120	4.5	Inductive: 200mA/28Vdc (320mH)
Lamp: 100mA/28Vdc		9	280	6.8	Lamp: 100mA/28Vdc
Low Level: 10 to 50 uA/10 to 50 mV		12	500	9.0	Low Level: 10 to 50 uA/10 to 50 mV
		18	1130	13.5	
50 g's	 J421DD (M39016/28)	5	48	4.5	Resistive: 1A/28Vdc
		6	97	5.5	Inductive: 200mA/28Vdc (320mH)
		9	280	7.8	Lamp: 100mA/28Vdc
		12	500	10.0	Low Level: 10 to 50 uA/10 to 50 mV
		18	1130	14.5	
	26	2000	19.0		

*See Schematics on Page 27

MILITARY QUALIFIED (JAN)

MILITARY QUALIFIED (JAN) RELAYS



Series J420 & J422 Electromechanical Relays

The magnetic-latching TO-5 relay, originally conceived and developed by Teledyne, has become one of the industry standards for low-level switching from dry circuit to 1 ampere. Designed for high-density PC board mounting, its small size and low coil power dissipation make the J420 & J422 relays some of the most versatile ultraminiature relays available.

The Series J420D/J422D and J420DD/J422DD utilize discrete silicon diodes for coil suppression and polarity reversal protection.

The Series J420/J422 magnetic-latching relays are ideally suited for applications where coil power dissipation must be minimized. The relays can be operated with a short duration pulse. After the contacts have transferred, no external holding power is required. The magnetic-latching feature of the Series J420/J422 relays provide a "memory" capability, since the relays will not reset upon removal of coil power.

- All welded construction
- Unique uni-frame design providing high magnetic efficiency and mechanical rigidity
- High force/mass ratio for resistance to shock and vibration
- Precious metal alloy contact material with gold plating assures excellent high current and dry circuit switching capabilities

Relay Type		Part No.	Nominal Coil			Contact Load Rating	
DPDT Magnetic-Latching			Voltage (Vdc)	Resistance (Ω)	Set & Reset Voltage (Vdc)		
Grounding Options			J420 (M39016/12)	5	61	3.5	Resistive: 1A/28Vdc Inductive: 200mA/28Vdc (320mH) Lamp: 100mA/28Vdc Low Level: 10 to 50 uA/10 to 50 mV
J420 = Common				6	120	4.5	
J422 = Individual			J422 (M39016/12)	9	280	6.8	
Diode Options				J420D (M39016/29)	12	500	
D = Internal diode for coil transient suppression			J422D (M39016/29)	18	1130	13.5	
DD = Internal diode for coil transient suppression and polarity reversal protection			J420DD (M39016/30)	26	2000	18.0	
Vibration	Shock		J420DD (M39016/30)	5	48	4.5	Resistive: 1A/28Vdc Inductive: 200mA/28Vdc (320mH) Lamp: 100mA/28Vdc Low Level: 10 to 50 uA/10 to 50 mV
30 g's	100 g's 6 msec,			6	97	5.5	
to 3000 Hz	half-sine		9	280	7.8		
Acceleration	Temperature		J422DD (M39016/30)	12	500	10.0	
50 g's	Operating & Storage: -65°C to +125°C		18	1130	14.5		
			26	2000	19.0		

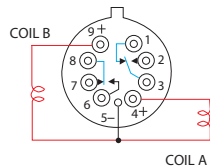

J420

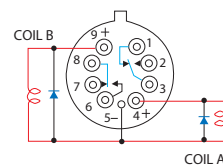

J420D

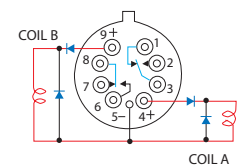

J420DD

Schematics Shown with Coil A Last Energized
Schematics as viewed from terminals

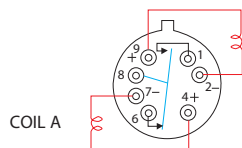

J421

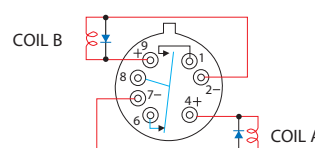

J421D

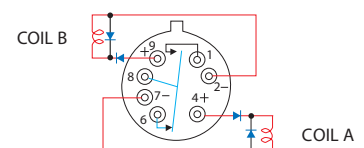

J421DD

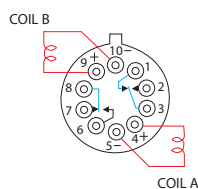

J422

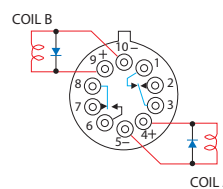

J422D

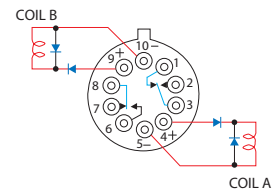

J422DD

HIGH-PERFORMANCE RELAYS

Series 412H, 422H & 432H Electromechanical Relays - High Temperature

The TO-5 relay, originally conceived and developed by Teledyne, has become one of the industry standards for low-level switching from dry circuit to 1 ampere. Designed for high-density PC board mounting, these TO-5 relays are some of the most versatile ultraminiature relays available because of their small size and low coil power dissipation.



The H Series high-temperature TO-5 relays are designed for reliable operation in elevated ambient temperatures up to 200°C. Special material selection and processing provide assurance of freedom from contact contamination and mechanical malfunctioning that might otherwise be caused by ultra high ambient temperature conditions.

Typical applications:

- Oil exploration (down-hole) instrumentation
- High-Temperature industrial and process control instrumentation

- All welded construction
- Unique uni-frame design providing high magnetic efficiency and mechanical rigidity
- High force/mass ratio for resistance to shock and vibration
- Precious metal alloy contact material with gold plating assures excellent high current and dry circuit switching capabilities

Relay Type
412H = DPDT Non-Latching
432H = DPDT Non-Latching
422H = DPDT Magnetic-Latching
Coil Type
412H = Standard Coil
422H = Standard Coil
432H = Sensitive Coil
Vibration
30 g's to 3000 Hz
Shock
412H = 75 g's 6 msec, half-sine
432H = 75 g's 6 msec, half-sine
422H = 100 g's
Acceleration
50 g's
Temperature
Operating & Storage: -65°C to +200°C

Part No.	Nominal Coil					Contact Load Rating
	Voltage (Vdc)	Resistance (Ω)	P.U.V (Vdc) (max.)	D.O.V (Vdc)		
				min.	max.	
 412H	5	50	4.7	0.14	2.4	Resistive: 1A/28Vdc Inductive: 200mA/28Vdc (320mH) Lamp: 100mA/28Vdc Low Level: 10 to 50 uA/10 to 50 mV
	6	98	5.9	0.18	3.4	
	9	220	9.0	0.35	5.1	
	12	390	11.9	0.41	6.8	
	18	880	17.8	0.59	10.2	
 432H	5	100	4.7	0.14	2.4	Resistive: 1A/28Vdc Inductive: 200mA/28Vdc (320mH) Lamp: 100mA/28Vdc Low Level: 10 to 50 uA/10 to 50 mV
	6	200	5.9	0.18	3.4	
	9	400	9.0	0.35	5.1	
	12	850	11.9	0.41	6.8	
	18	1600	17.8	0.59	10.2	
26	3300	24.0	0.89	13.5		

Part No.	Nominal Coil			Contact Load Rating
	Voltage (Vdc)	Resistance (Ω)	Set & Reset Voltage (Vdc)	
 422H	5	61	4.7	Resistive: 1A/28Vdc Inductive: 200mA/28Vdc (320mH) Lamp: 100mA/28Vdc Low Level: 10 to 50 uA/10 to 50 mV
	6	120	5.9	
	9	280	9.0	
	12	500	11.9	
	18	1130	17.8	
26	2000	24.0		

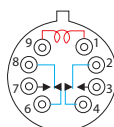

412H
432H

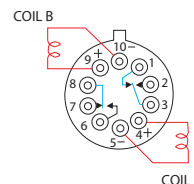

SCHEMATIC
(Coil A Last Energized)
422H

Schematics as viewed from terminals

P.U.V = Pick-Up Voltage

D.O.V = Drop-Out Voltage

HIGH-PERFORMANCE RELAYS

Series 412K & 422K Electromechanical Relays - High Shock

The TO-5 relay, originally conceived and developed by Teledyne, has become one of the industry standards for low-level switching from dry circuit to 1 ampere. Designed for high-density PC board mounting, its small size and low coil power dissipation make the TO-5 relay one of the most versatile subminiature relays available.

The K Series high-shock TO-5 relays are designed to withstand shock levels up to 4000 g's, .5 msec duration. Special material selection and construction details provide assurance that critical elements of the relay structure and mechanism will not be permanently displaced or damaged as a result of extremely high g level shocks.

Typical applications:

- Commercial avionics aircraft control
- Commercial aircraft control systems
- Transportation systems (rail/truck)

- All welded construction
- Unique uni-frame design providing high magnetic efficiency and mechanical rigidity
- High force/mass ratio for resistance to shock and vibration
- Precious metal alloy contact material with gold plating assures excellent high current and dry circuit switching capabilities

Relay Type	Part No.	Nominal Coil					Contact Load Rating
		Voltage (Vdc)	Resistance (Ω)	P.U.V (Vdc) (max.)	D.O.V (Vdc)		
					min.	max.	
412K = DPDT Non-Latching	 412K	5	50	4.3	0.14	2.5	Resistive: 1A/28Vdc Inductive: 200mA/28Vdc (320mH) Lamp: 100mA/28Vdc Low Level: 10 to 50 uA/10 to 50 mV
422K = DPDT Magnetic-Latching		6	80	5.2	0.18	3.2	
Vibration		9	160	7.6	0.35	4.9	
30 g's to 3000 Hz		12	300	10.0	0.41	6.5	
Shock		18	600	14.3	0.59	10.0	
412K = 75 g's 6 msec, half-sine		26	1350	21.0	0.89	13.0	

Relay Type	Part No.	Nominal Coil			Contact Load Rating
		Voltage (Vdc)	Resistance (Ω)	Set & Reset Voltage (Vdc)	
2100 g's, 0.5 msec axial plane, half-sine	6	120	4.5		
1000 g's, 0.5 msec side planes, half-sine	9	280	6.8		
422K = 100 g's 6 msec, half-sine	12	500	9.0		
2100 g's, 0.5 msec axial plane, half-sine	18	1130	13.5		
750 g's, 0.5 msec side planes, half-sine	26	2000	18.0		

Acceleration
50 g's
Temperature
Operating & Storage: -65°C to +125°C

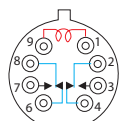

412K

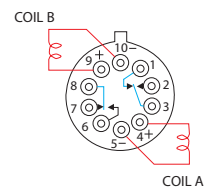

SCHEMATIC
(Coil A Last Energized)

422K

Schematics as viewed from terminals

P.U.V = Pick-Up Voltage

D.O.V = Drop-Out Voltage

HIGH-PERFORMANCE RELAYS

Series 412V & 432V Electromechanical Relays - High Vibration



The 412V and 432V TO-5 relays, originally conceived and developed by Teledyne, have become the industry standards for low level switching from dry circuit to 1 ampere in high-vibration environments. Designed for high-density PC board mounting, these TO-5 relays are some of the most versatile ultraminiature relay available because of their small size and low coil power dissipation.

The V Series high-vibration relays are designed to withstand vibration levels of 250 to 380 g's at the frequencies noted, when tested on a resonant beam for 10 to 20 seconds, in the axis parallel to contact motion (x-axis), or 100 g's 10-2000 Hz for 20 minutes in the x-axis. A unique magnetic circuit prevents contact opening (chatter) in excess of 10 microseconds under vibration or shock conditions.

Typical applications:

- Avionics aircraft control
- Aircraft control systems
- Transportation systems (rail/truck)

- All welded construction
- Unique uni-frame design providing high magnetic efficiency and mechanical rigidity
- High force/mass ratio for resistance to shock and vibration
- Precious metal alloy contact material with gold plating assures excellent high current and dry circuit switching capabilities

Relay Type	Part No.	Nominal Coil					Contact Load Rating		
		Voltage (Vdc)	Resistance (Ω)	P.U.V (Vdc) (max.)	D.O.V (Vdc)				
Coil Type					min.	max.			
DPDT Non-Latching									
Coil Type									
412V = Standard Coil			412V 412DV	5	50	4.6	0.14	2.3	Resistive: 1A/28Vdc Inductive: 200mA/28Vdc (320mH) Lamp: 100mA/28Vdc Low Level: 10 to 50 uA/10 to 50 mV
432V = Sensitive Coil				6	70	5.5	0.18	3.2	
Diode Options				9	155	8.2	0.35	4.9	
D = Internal diode for coil transient suppression				12	235	11.0	0.41	6.5	
DD = Internal diode for coil transient suppression and polarity reversal protection				18	610	16.5	0.59	10.0	
Vibration		26	1130	22.0	0.89	13.0			
250 g's at 140 ±5 Hz			412DDV	5	33	4.6	0.6	2.8	Resistive: 1A/28Vdc Inductive: 200mA/28Vdc (320mH) Lamp: 100mA/28Vdc Low Level: 10 to 50 uA/10 to 50 mV
350 g's at 170 ±5 Hz				6	44	5.5	0.7	3.4	
380 g's at 200 ±5 Hz				9	125	8.2	0.8	5.3	
Shock				12	215	11.0	0.9	6.5	
150 g's 11 msec, half-sine				18	470	16.5	1.1	10.0	
Acceleration		26	1050	22.0	1.4	13.0			
50 g's			432V 432DV	5	80	4.6	0.14	2.5	Resistive: 1A/28Vdc Inductive: 200mA/28Vdc (320mH) Lamp: 100mA/28Vdc Low Level: 10 to 50 uA/10 to 50 mV
Temperature				6	120	5.5	0.18	3.2	
Operating & Storage:				9	240	8.2	0.35	4.9	
-65°C to +125°C				12	480	11.0	0.41	6.5	
				18	950	16.5	0.59	10.0	
		26	1900	22.0	0.89	13.0			

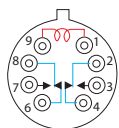

412V
432V

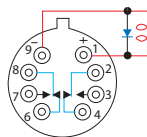

412DV
432DV

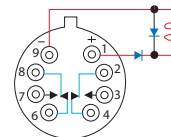

412DDV

Schematics as viewed from terminals

P.U.V = Pick-Up Voltage

D.O.V = Drop-Out Voltage

APPENDIX: SIGNAL INTEGRITY EYE DIAGRAMS

SERIES LB363

AC BYPASS (Capacitor Path) @ 16 Gbps

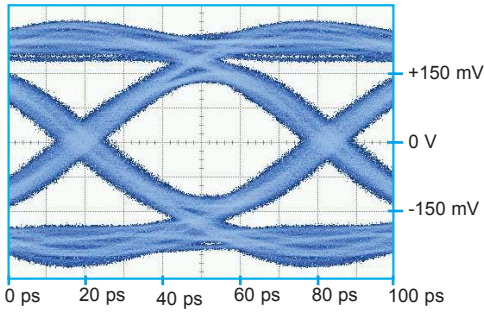

Bit Rate	Eye Height	Eye Width	Jitter _{P-P}
16 Gbps	170 mV	46.0 ps	16.44 ps

Normally Closed Path @ 16 Gbps

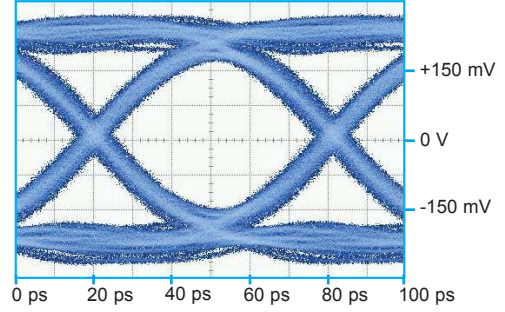

Bit Rate	Eye Height	Eye Width	Jitter _{P-P}
16 Gbps	262 mV	49.8 ps	11.33 ps

SERIES GLB363

AC BYPASS (Capacitor Path) @ 16 Gbps

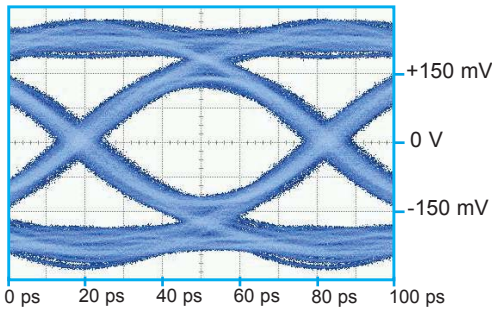

Bit Rate	Eye Height	Eye Width	Jitter _{P-P}
16 Gbps	157 mV	49.4 ps	14.22 ps

Normally Closed Path @ 16 Gbps

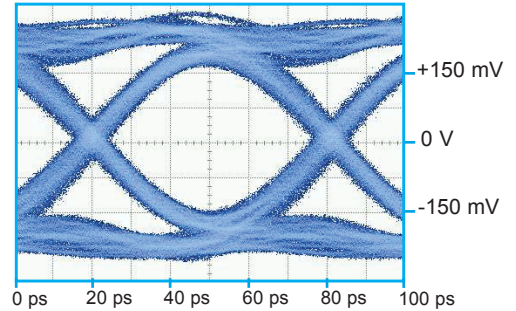

Bit Rate	Eye Height	Eye Width	Jitter _{P-P}
16 Gbps	251 mV	49.2 ps	10.67 ps

SERIES SGLB363

AC BYPASS (Capacitor Path) @ 16 Gbps

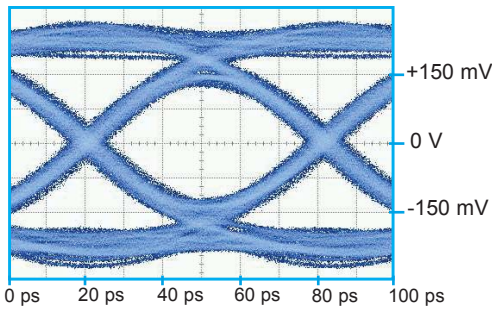

Bit Rate	Eye Height	Eye Width	Jitter _{P-P}
16 Gbps	173 mV	48.3 ps	12.67 ps

Normally Closed Path @ 16 Gbps

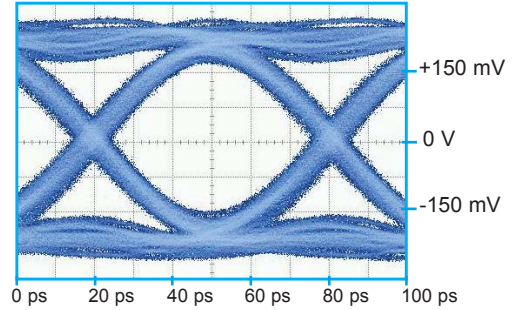

Bit Rate	Eye Height	Eye Width	Jitter _{P-P}
16 Gbps	288 mV	47.9 ps	11.56 ps

APPENDIX: SIGNAL INTEGRITY EYE DIAGRAMS

SERIES RF300/RF303

Normally Closed

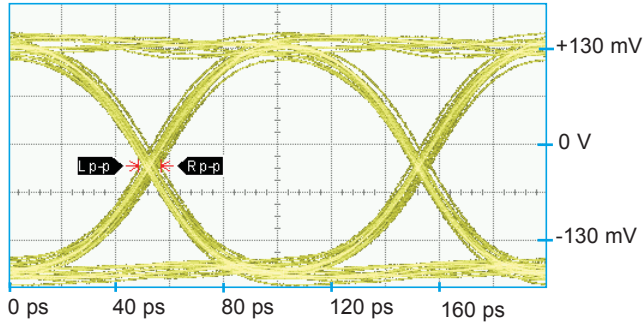

Eye Height	Eye Width	SNR	Jitter _{p-p}
254.7 mV	90.38 ps	18.52	8.44 ps

Normally Open

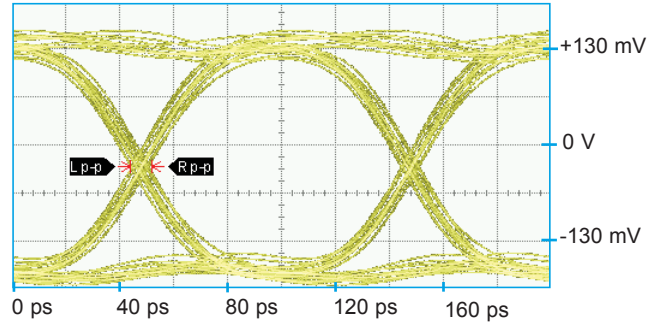

Eye Height	Eye Width	SNR	Jitter _{p-p}
250.9 mV	88.21 ps	16.84	8.00 ps

SERIES SRF300/SRF303

Normally Closed

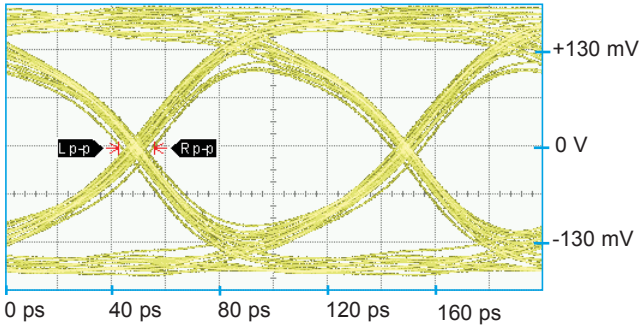

Eye Height	Eye Width	SNR	Jitter _{p-p}
137.9 mV	85.83 ps	6.31	13.33 ps

Normally Open

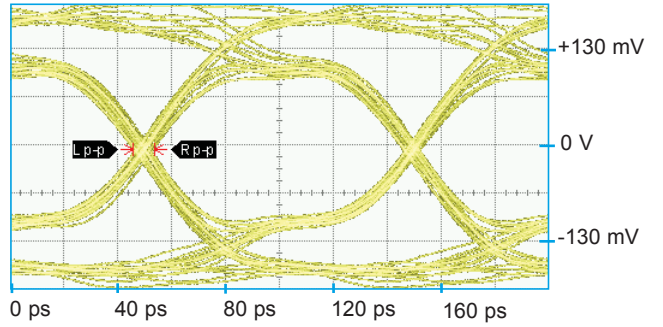

Eye Height	Eye Width	SNR	Jitter _{p-p}
72.8 mV	88.1 ps	4.31	8.00 ps

SERIES GRF300/GRF303

Normally Closed

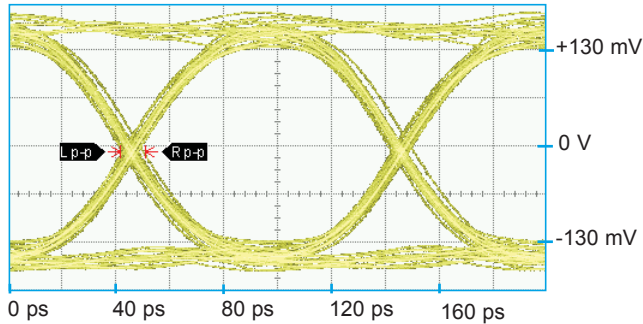

Eye Height	Eye Width	SNR	Jitter _{p-p}
237.6 mV	90.08 ps	14.19	9.33 ps

Normally Open

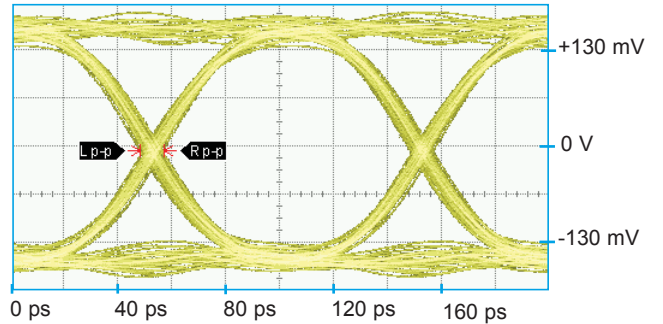

Eye Height	Eye Width	SNR	Jitter _{p-p}
255.2 mV	88.93 ps	17.74	8.89 ps

APPENDIX: SIGNAL INTEGRITY EYE DIAGRAMS

SERIES SGRF300/SGRF303

Normally Closed

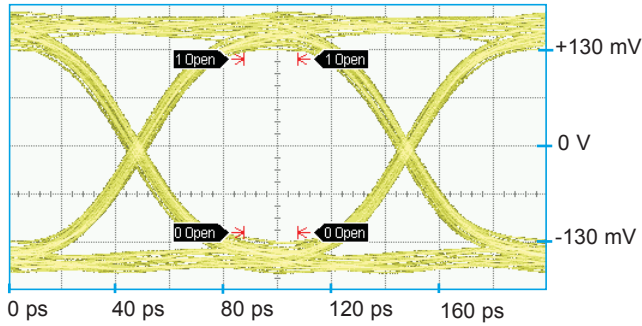

Eye Height	Eye Width	SNR	Jitter _{P-P}
233.3 mV	89.08 ps	13.18	7.56 ps

Normally Open

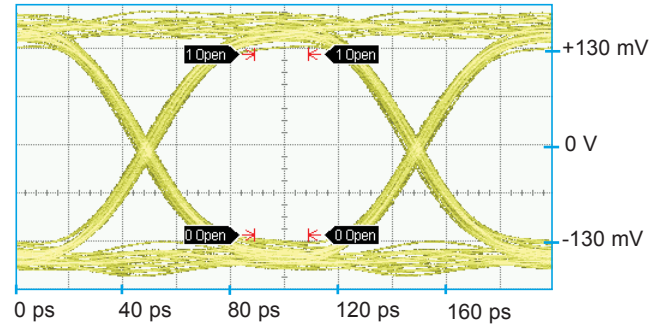

Eye Height	Eye Width	SNR	Jitter _{P-P}
243.1 mV	90.29 ps	15.21	7.56 ps

SERIES RF312

Normally Closed

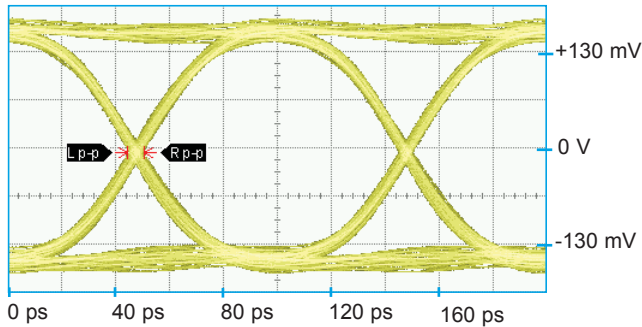

Eye Height	Eye Width	SNR	Jitter _{P-P}
266.5 mV	89.21 ps	19.44	9.78 ps

Normally Open

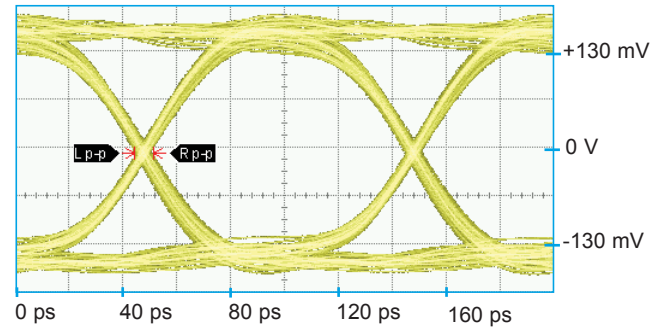

Eye Height	Eye Width	SNR	Jitter _{P-P}
264.3 mV	89.07 ps	19.13	8.00 ps

SERIES GRF312

Normally Closed

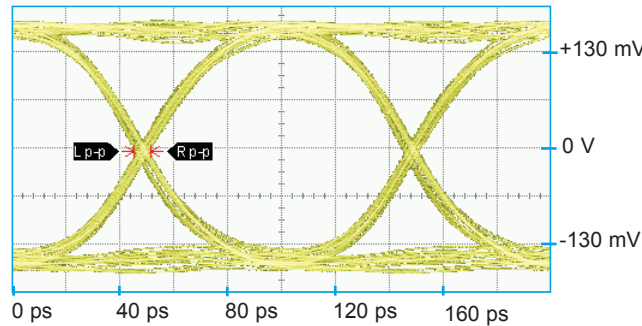

Eye Height	Eye Width	SNR	Jitter _{P-P}
266.5 mV	91.09 ps	20.75	6.22 ps

Normally Open

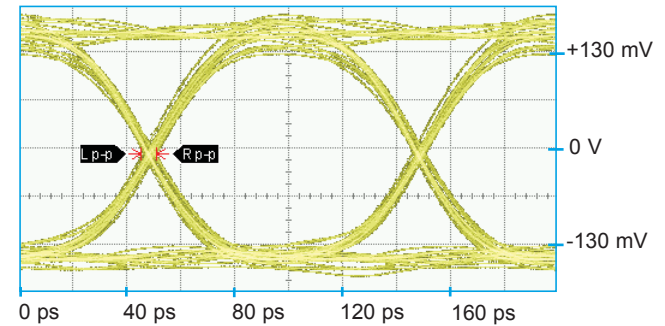

Eye Height	Eye Width	SNR	Jitter _{P-P}
239.6 mV	92.77 ps	14.52	5.78 ps

APPENDIX: SIGNAL INTEGRITY EYE DIAGRAMS

SERIES SGRF312

Normally Closed

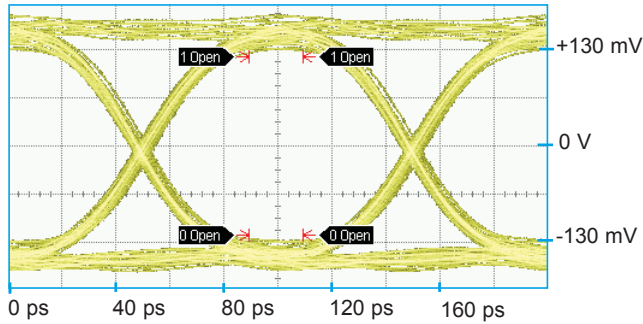

Eye Height	Eye Width	SNR	Jitter _{P-P}
240.7 mV	91.44 ps	15.49	8.44 ps

Normally Open

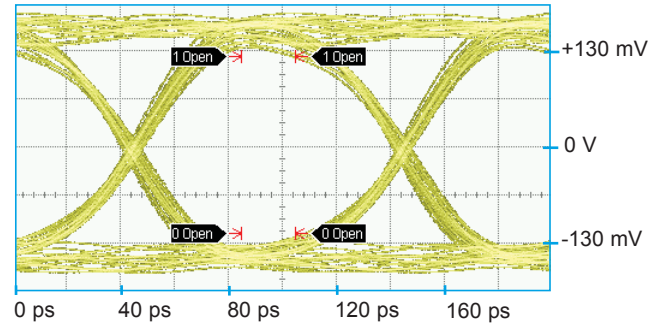

Eye Height	Eye Width	SNR	Jitter _{P-P}
237.1 mV	89.08 ps	13.72	8.00 ps

SERIES RF100

Normally Closed

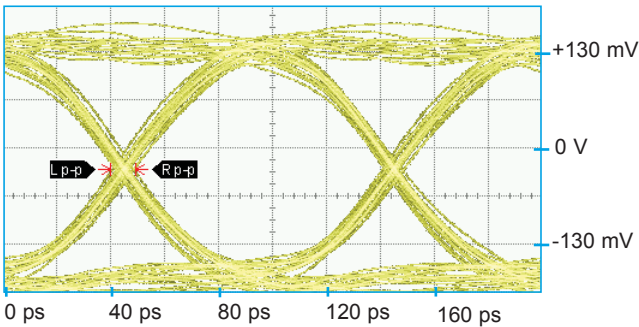

Eye Height	Eye Width	SNR	Jitter _{P-P}
233.7 mV	88.88 ps	13.01	9.33 ps

Normally Open

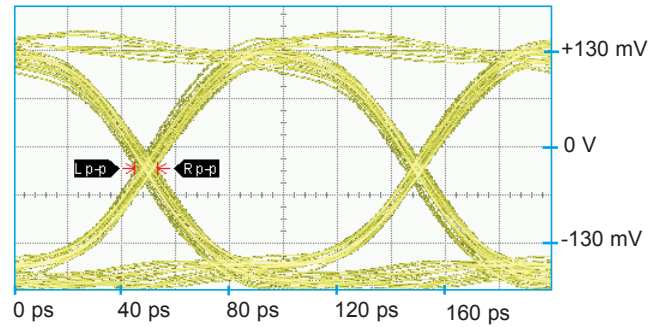

Eye Height	Eye Width	SNR	Jitter _{P-P}
217.1 mV	88.05 ps	11.55	8.44 ps

SERIES GRF100

Normally Closed

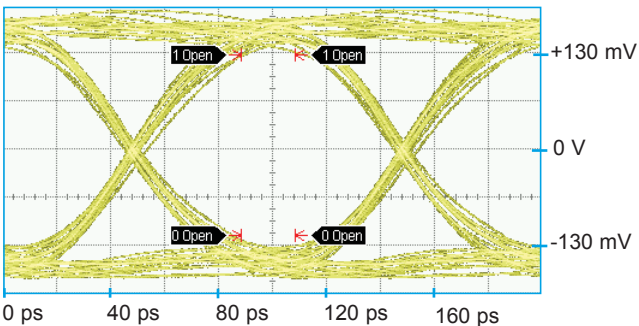

Eye Height	Eye Width	SNR	Jitter _{P-P}
242.5 mV	90.09 ps	14.20	8.44 ps

Normally Open

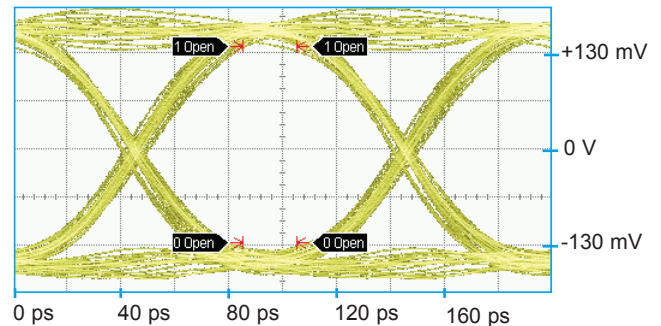

Eye Height	Eye Width	SNR	Jitter _{P-P}
263.6 mV	87.29 ps	20.23	9.78 ps

APPENDIX: SIGNAL INTEGRITY EYE DIAGRAMS

SERIES SGRF100

Normally Closed

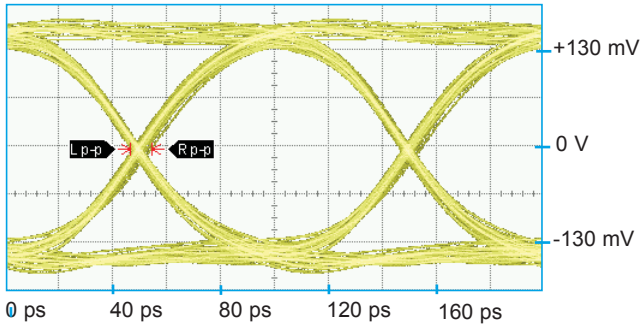

Eye Height	Eye Width	SNR	Jitter _{p-p}
251.5 mV	92.04 ps	15.11	8.00 ps

Normally Open

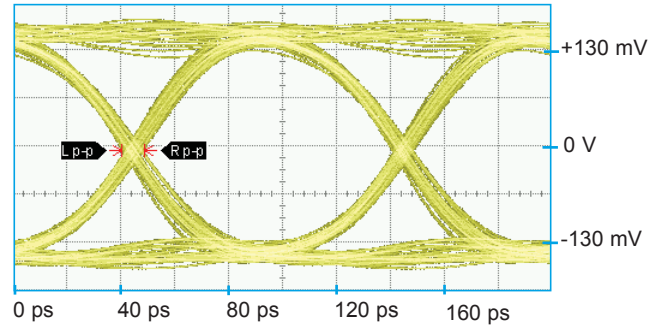

Eye Height	Eye Width	SNR	Jitter _{p-p}
261.2 mV	87.64 ps	18.20	8.44 ps

SERIES GRF172

Normally Closed

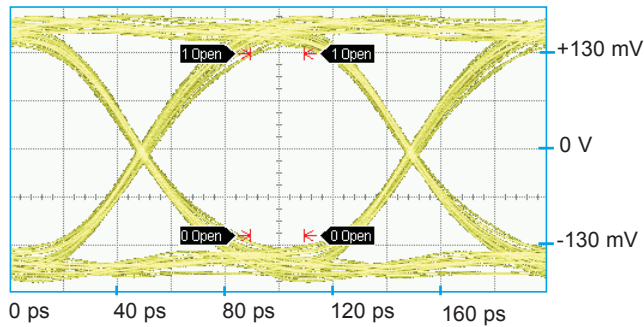

Eye Height	Eye Width	SNR	Jitter _{p-p}
246.1 mV	92.45 ps	14.59	6.22 ps

Normally Open

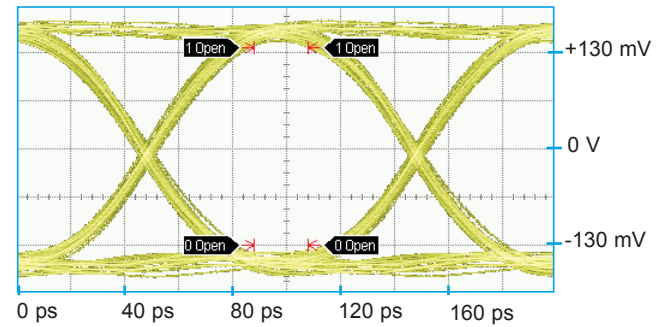

Eye Height	Eye Width	SNR	Jitter _{p-p}
268.2 mV	90.87 ps	21.62	7.56 ps

SERIES RF311/RF331

Normally Closed

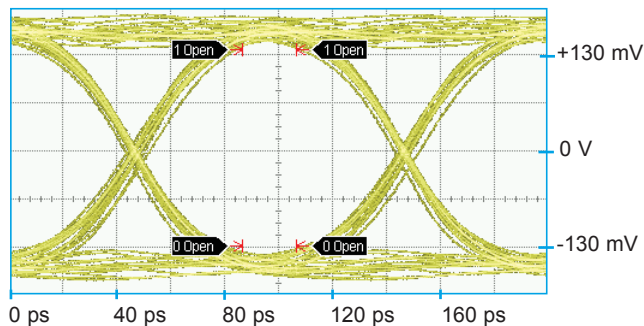

Eye Height	Eye Width	SNR	Jitter _{p-p}
266.5 mV	89.21 ps	19.44	9.78 ps

Normally Open

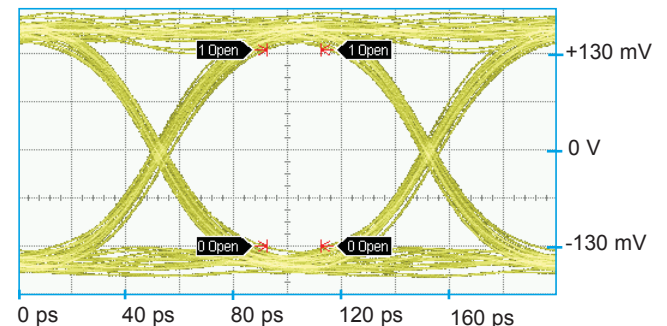

Eye Height	Eye Width	SNR	Jitter _{p-p}
264.3 mV	89.07 ps	19.13	8.00 ps

APPENDIX: SIGNAL INTEGRITY EYE DIAGRAMS

SERIES GRF311/GRF331

Normally Closed

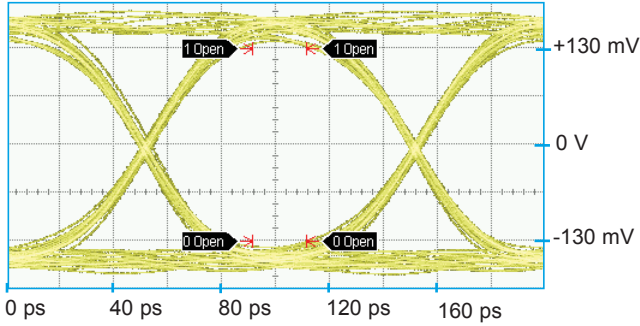

Eye Height	Eye Width	SNR	Jitter _{p-p}
260.0 mV	92.32 ps	17.98	6.67 ps

Normally Open

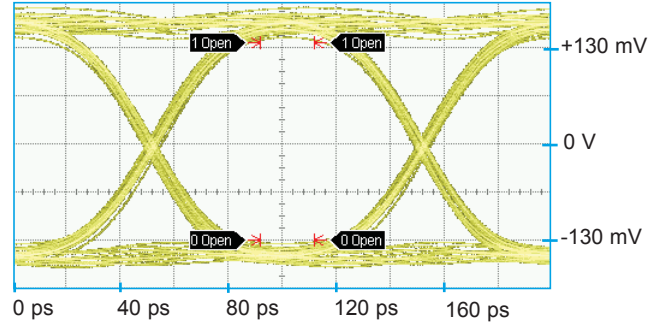

Eye Height	Eye Width	SNR	Jitter _{p-p}
267.2 mV	90.99 ps	20.84	7.11 ps

SERIES RF341

Normally Closed

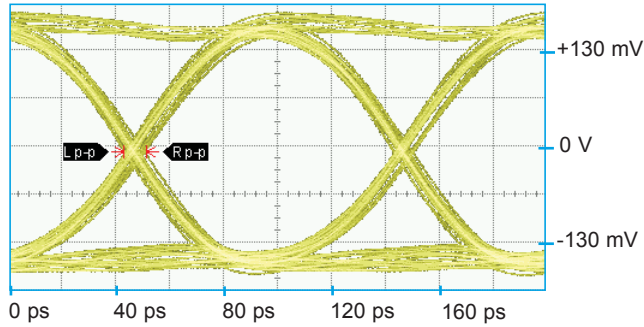

Eye Height	Eye Width	SNR	Jitter _{p-p}
260.9 mV	88.26 ps	18.39	8.44 ps

Normally Open

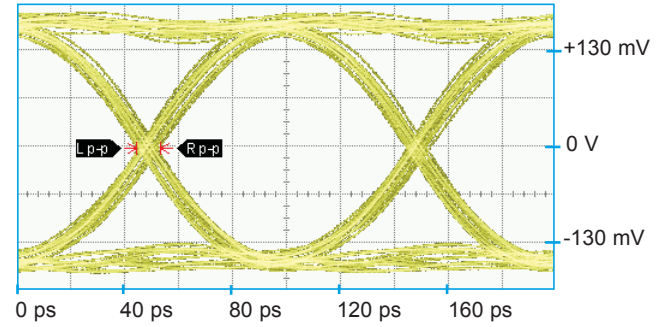

Eye Height	Eye Width	SNR	Jitter _{p-p}
271.5 mV	86.41 ps	21.35	8.89 ps

SERIES GRF341

Normally Closed

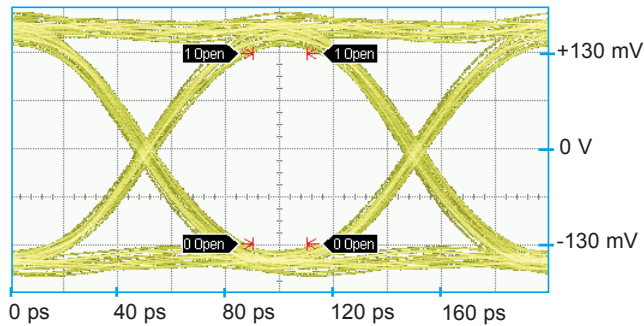

Eye Height	Eye Width	SNR	Jitter _{p-p}
256.2 mV	87.70 ps	17.15	8.89 ps

Normally Open

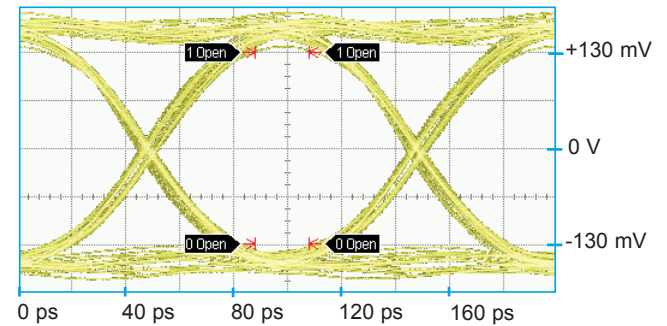

Eye Height	Eye Width	SNR	Jitter _{p-p}
259.9 mV	88.39 ps	17.59	8.00 ps

APPENDIX: SIGNAL INTEGRITY EYE DIAGRAMS

SERIES GRF342

Normally Closed

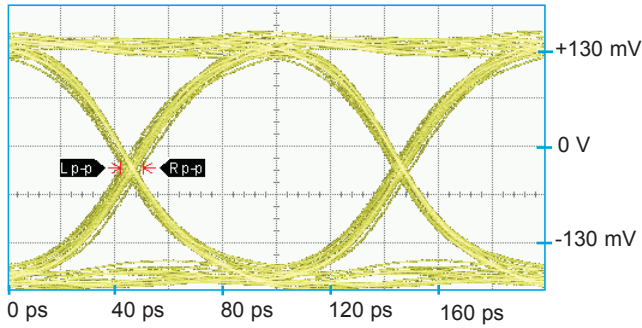

Eye Height	Eye Width	SNR	Jitter _{p-p}
252.9 mV	90.74 ps	16.53	8.44 ps

Normally Open

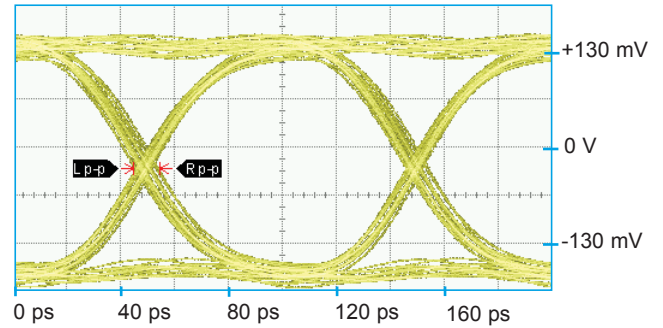

Eye Height	Eye Width	SNR	Jitter _{p-p}
253.1 mV	87.31 ps	17.57	9.78 ps

SERIES RF180

Normally Closed

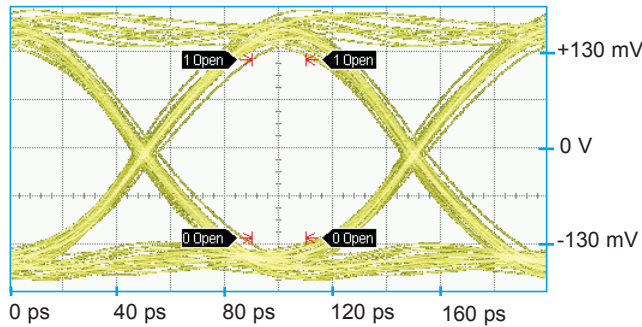

Eye Height	Eye Width	SNR	Jitter _{p-p}
240.5 mV	88.16 ps	13.86	10.67 ps

Normally Open

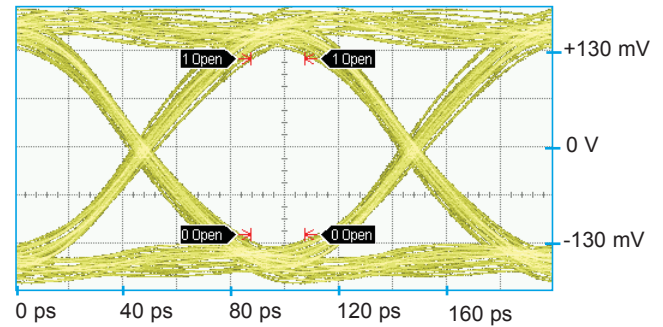

Eye Height	Eye Width	SNR	Jitter _{p-p}
235.8 mV	87.22 ps	12.75	10.22 ps

SERIES GRF180

Normally Closed

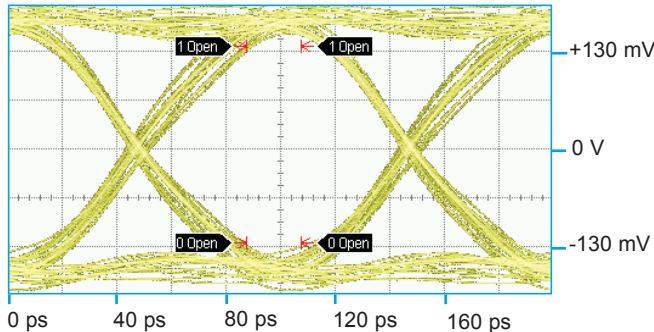

Eye Height	Eye Width	SNR	Jitter _{p-p}
262.1 mV	87.07 ps	15.18	9.78 ps

Normally Open

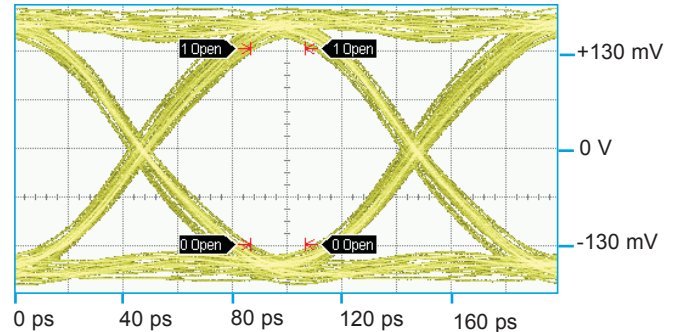

Eye Height	Eye Width	SNR	Jitter _{p-p}
260.6 mV	87.05 ps	16.26	10.22 ps

APPENDIX: SIGNAL INTEGRITY EYE DIAGRAMS

SERIES RF424

Typical Path

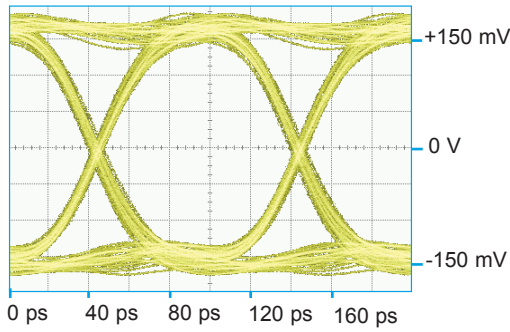

Eye Height	Eye Width	SNR	Jitter _{P-P}
254.0 mV	90.27 ps	15.61	8.89 ps

SERIES GRF424

Normally Closed

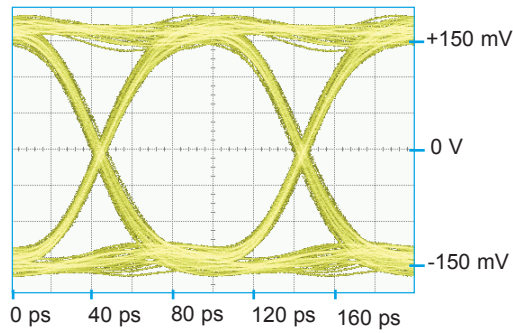

Eye Height	Eye Width	SNR	Jitter _{P-P}
254.0 mV	90.27 ps	15.61	8.89 ps

SERIES SGRF424

Normally Closed

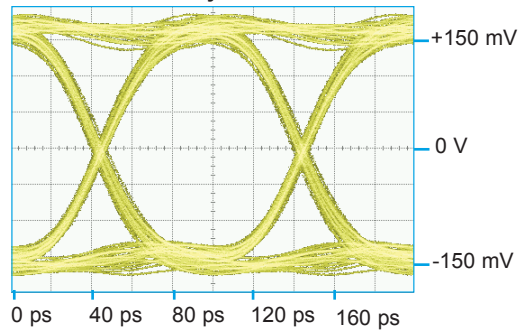

Eye Height	Eye Width	SNR	Jitter _{P-P}
254.0 mV	90.27 ps	15.61	8.89 ps

APPENDIX: SIGNAL INTEGRITY EYE DIAGRAMS

SERIES RF310/RF313

Normally Closed

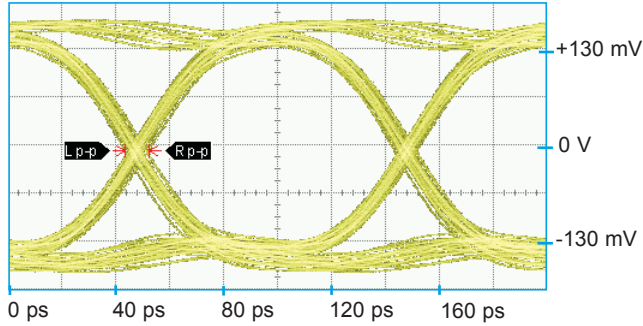

Eye Height	Eye Width	SNR	Jitter _{p-p}
246.1 mV	92.45 ps	14.59	6.22 ps

Normally Open

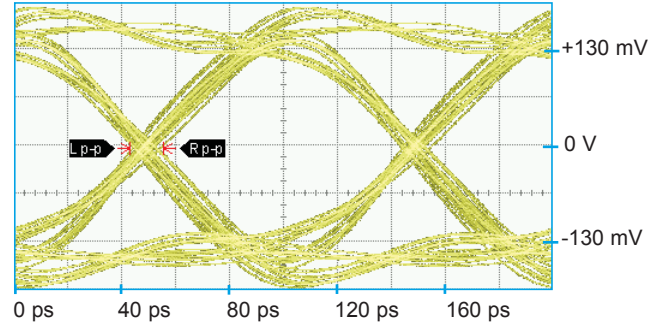

Eye Height	Eye Width	SNR	Jitter _{p-p}
268.2 mV	90.87 ps	21.62	7.56 ps

SERIES RF320/RF323

Normally Closed

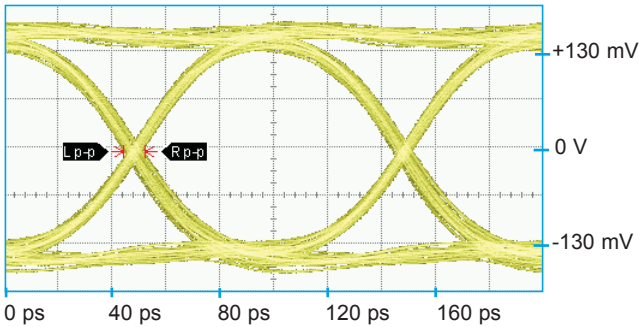

Eye Height	Eye Width	SNR	Jitter _{p-p}
246.1 mV	92.45 ps	14.59	6.22 ps

Normally Open

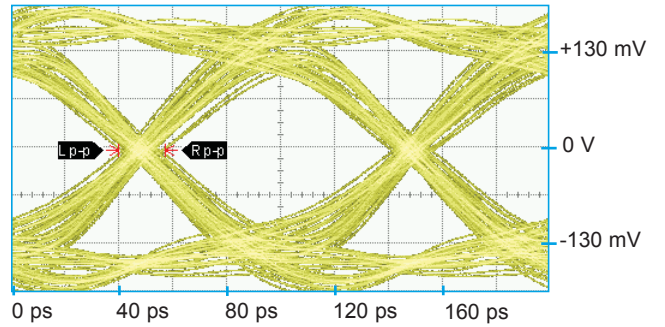

Eye Height	Eye Width	SNR	Jitter _{p-p}
268.2 mV	90.87 ps	21.62	7.56 ps

SERIES A150

Attenuated Path

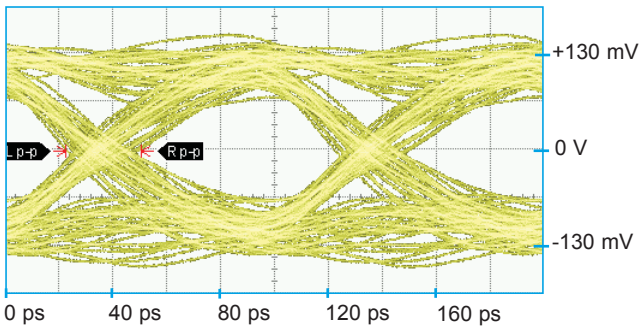

Eye Height	Eye Width	SNR	Jitter _{p-p}
45.59 mV	64.18 ps	5.70	28.00 ps

Thru Path

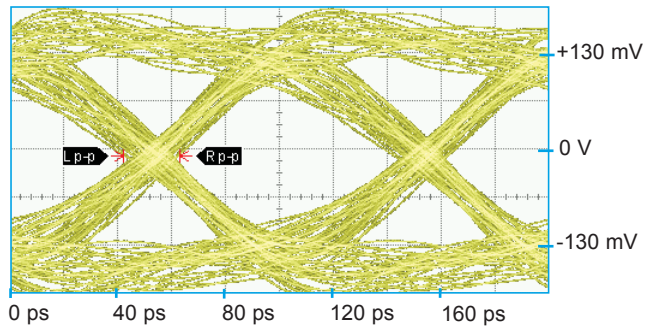

Eye Height	Eye Width	SNR	Jitter _{p-p}
130.2 mV	72.87 ps	5.29	20.89 ps

APPENDIX: SIGNAL INTEGRITY EYE DIAGRAMS

SERIES GA150

Attenuated Path

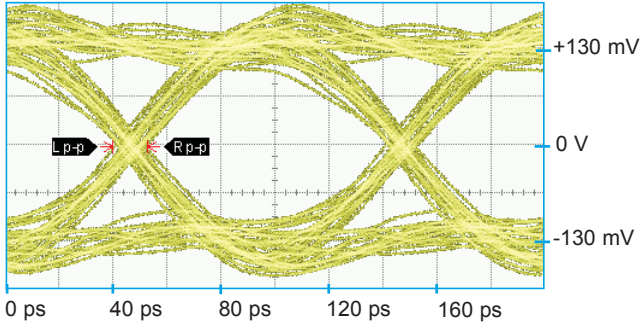

Eye Height	Eye Width	SNR	Jitter _{p-p}
62.10 mV	83.23 ps	7.14	12.89 ps

Thru Path

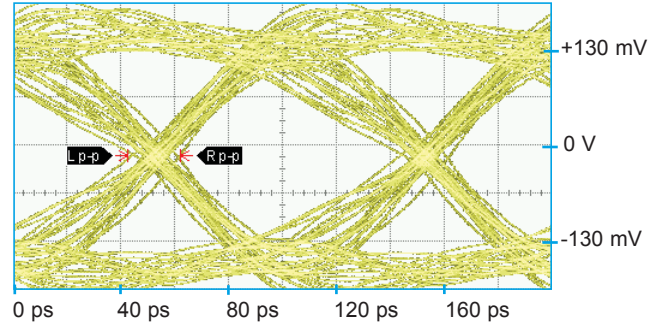

Eye Height	Eye Width	SNR	Jitter _{p-p}
130.3 mV	78.38 ps	5.30	19.56 ps

SERIES A152

Attenuated Path

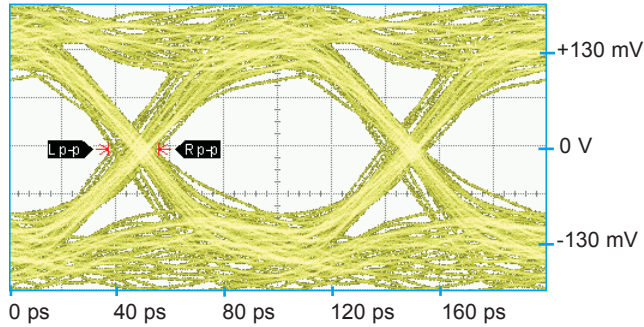

Eye Height	Eye Width	SNR	Jitter _{p-p}
45.10 mV	78.94 ps	5.57	18.67 ps

Thru Path

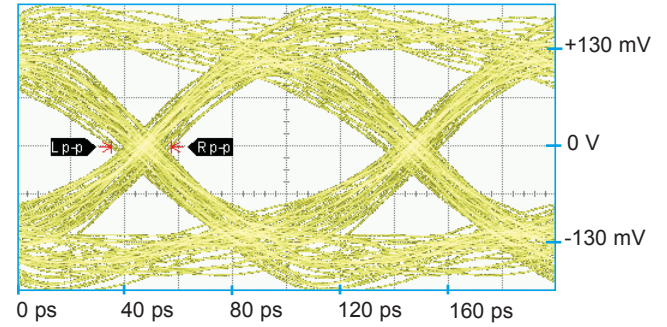

Eye Height	Eye Width	SNR	Jitter _{p-p}
124.5 mV	73.90 ps	5.23	22.22 ps

SERIES GA152

Attenuated Path

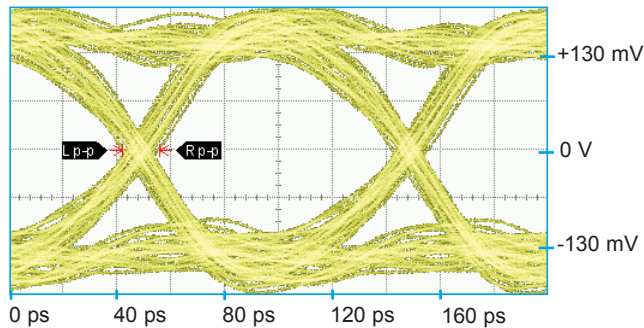

Eye Height	Eye Width	SNR	Jitter _{p-p}
67.99 mV	82.70 ps	7.85	13.78 ps

Thru Path

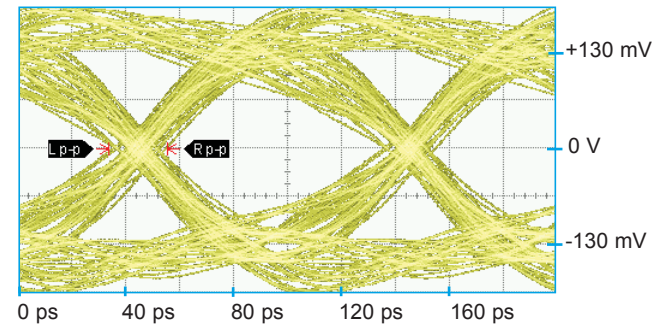

Eye Height	Eye Width	SNR	Jitter _{p-p}
122.9 mV	76.21 ps	5.07	21.78 ps

PATTERN GENERATOR SETTINGS

10 Gbps Random Pulse Pattern Generator
 2³¹ - 1 PRBS signal
 PRBS output of 300mV_{p-p} (nominal)
 RF PCB effect (negligible) not removed from measurement
 Data shown is typical of both poles

RoHS and REACH CERTIFICATE OF COMPLIANCE

RoHS

It is hereby stated and certified that Teledyne Relays complies with the Restrictions on Hazardous Substances (RoHS) Directives to the extent herein:

Teledyne Relays does not use any of the Restricted Substances specified by the RoHS Directives

(listed below) as components in TO-5 and Centigrad® Electromechanical Relay products, nor are these substances employed during any electromechanical relay manufacturing process:

Lead

Mercury

Cadmium

Hexavalent Chromium

Polybrominated Biphenyls (PBB's)

Polybrominated Diphenyl Ethers (PBDE's)

However, upon request from the Customer, relay leads may be coated with solder, which contains 60% tin and 40% lead.

REACH

It is hereby stated and certified that Teledyne Relays complies with the Registration Evaluation Authorization and Restriction of Chemicals (REACH) Directives to the extent stated herein:

Teledyne Relays is a manufacturer of articles. Teledyne Relays has taken the initiative to review the (126) substances that are under consideration for treatment as Substances of Very High Concern (SVHC) candidates. Teledyne Relays confirmed that our relays do not contain any of the listed substances in concentration >0.1% weight per supplied article, substance or preparation weight.



RoHS or Non-RoHS:
Your Choice!



**TELEDYNE
RELAYS**
Everywhereyoulook™

For Additional Information please E-Mail us at: relays@teledyne.com

APPENDIX: TELEDYNE RELAYS PART NUMBERING SYSTEM

LoopBack Relays

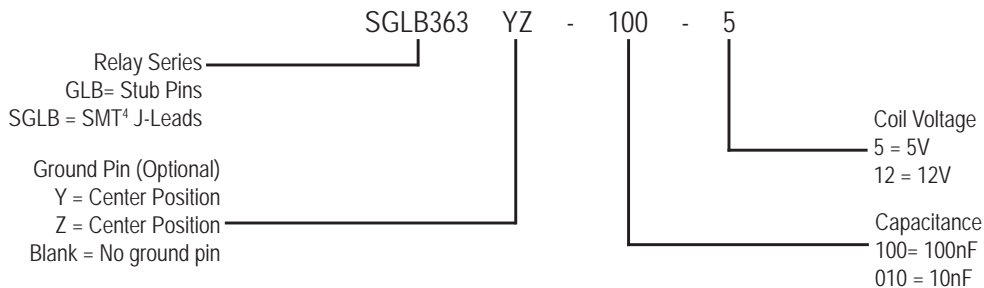
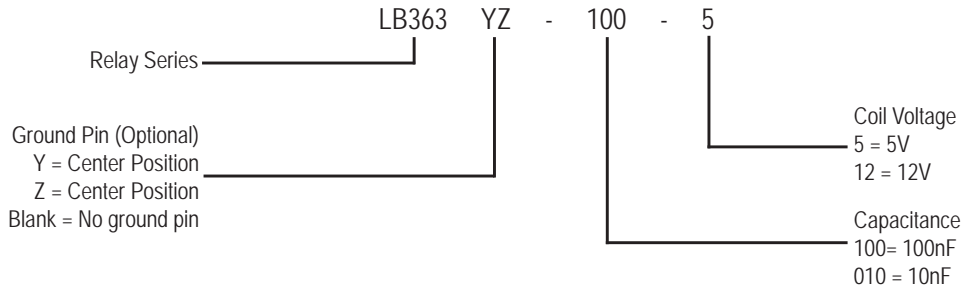

RF Relays (Except Attenuator Relays)

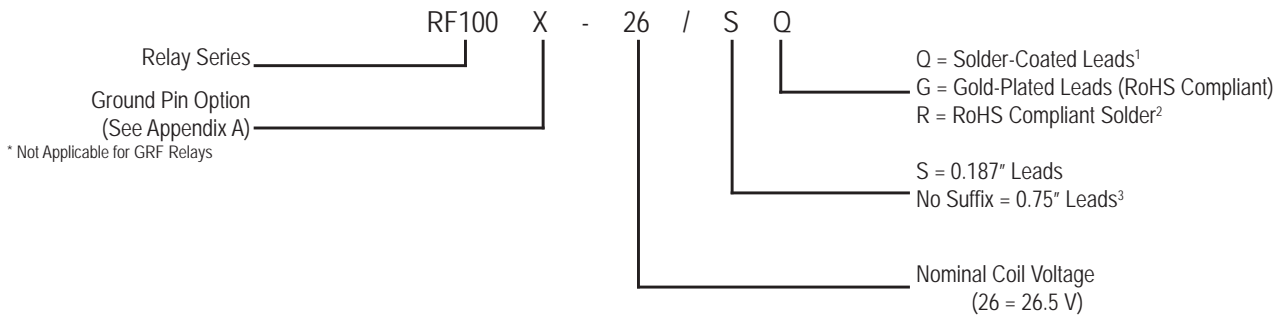

T²R Established Reliability Relays

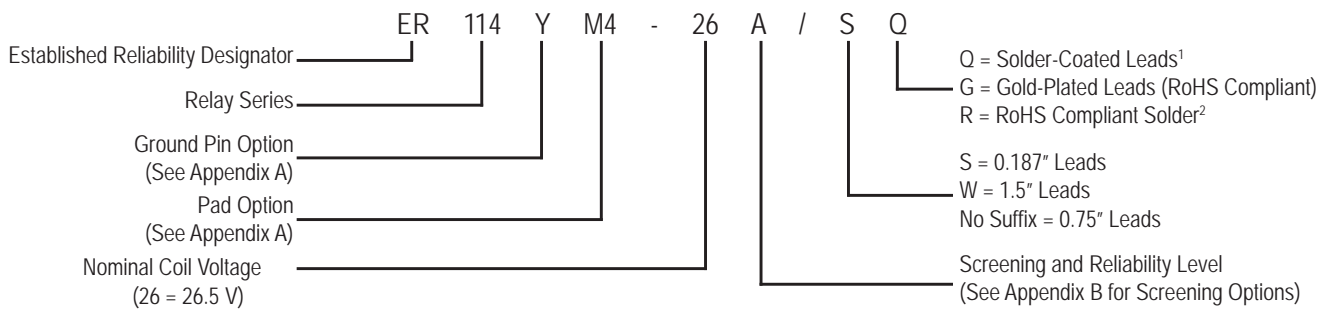

General Note: Parts ordered without suffix may be supplied with Solder-Coated or Gold-Plated leads

¹ Parts ordered with Solder-Coated leads will have (Sn60/Pb40)

² Parts ordered with RoHS Solder-Coated leads will have (Sn99.3/Cu0.7)

³ Not Applicable to GRF relays

⁴ SMT=Surface Mount Technology

APPENDIX: TELEDYNE RELAYS PART NUMBERING SYSTEM

Military Qualified (JAN) Relays

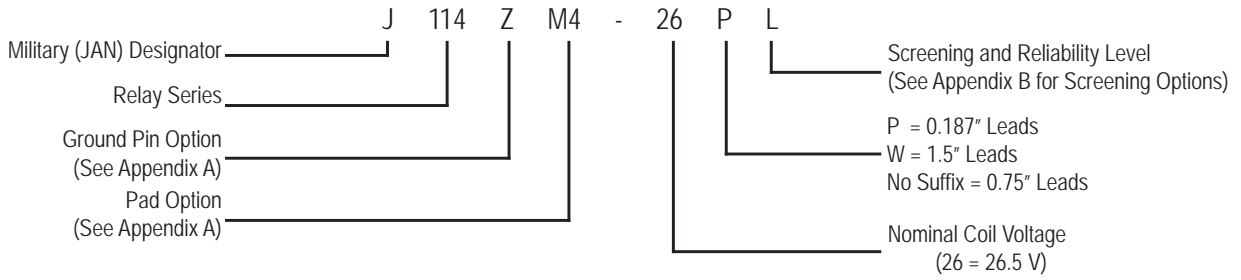

Commercial Surface Mount Relays

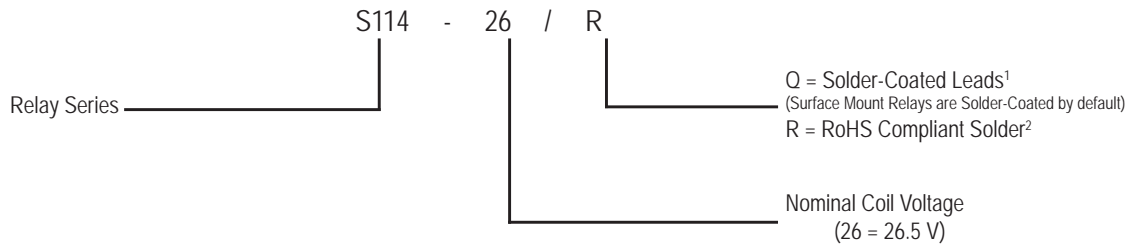

Commercial Relays, (Except Surface Mount Relays)

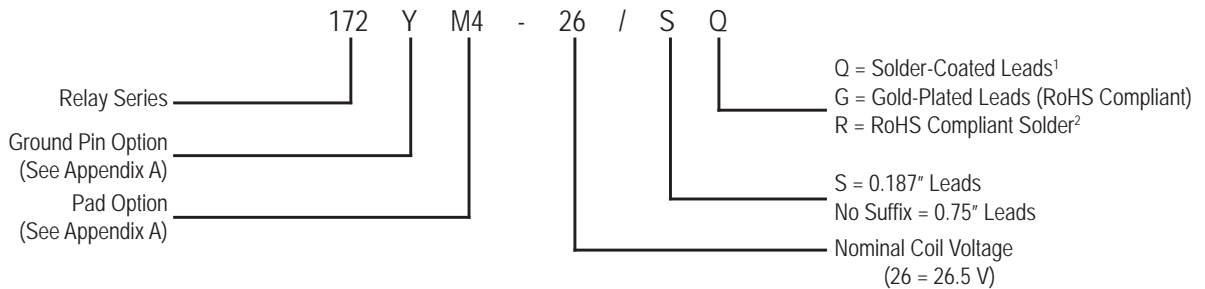

High Performance Relays

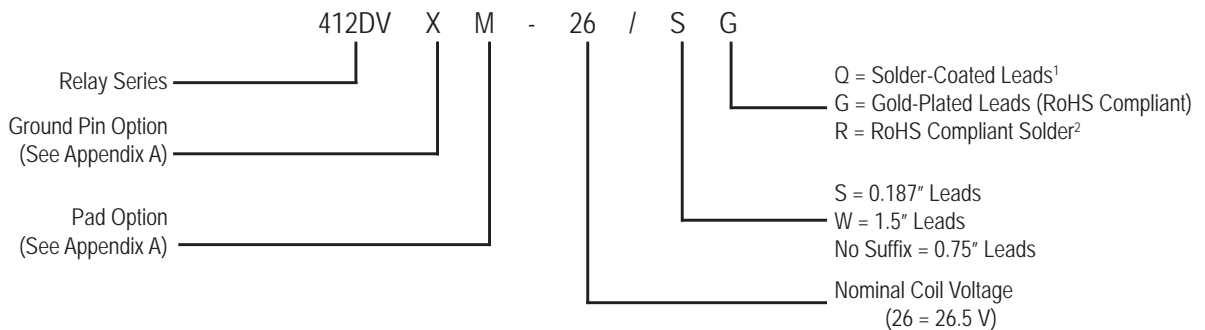

General Note: Parts ordered without suffix may be supplied with Solder-Coated or Gold-Plated leads.

¹ Parts ordered with Solder-Coated leads will have (Sn60/Pb40)

² Parts ordered with RoHS Solder-Coated leads will have (Sn99.3/Cu0.7)

Handling Guidelines for TO-5 and Centigrid® Relays

- 1)** Do not drop, throw or in any way mishandle individual relays, cartons containing relay packs, or individual relay packs.
- 2)** Store unused relays in a humidity controlled, shock and vibration-free environment. Storage temperature range limits -65°C to + 125°C, however, when possible, relays should be stored in a 25°C environment.
- 3)** Observe normal good practice in the handling and storage of any relay packs marked as static sensitive.
- 4)** When removing relays from packaging, do so with care. If removing relays from Styrofoam packaging, remove relays carefully as pouring them from the packaging may cause damage to the relay. If removing from bulk packaging, gently pour the relays from the container, taking care to not allow the relays to drop from the container onto the new surface, to prevent unnecessary shock. Do not allow relays to fall onto the floor.
- 5)** When transferring relays to the production area after unpacking, do not drop, throw, or mishandle the relays in any way. When removing relays from the container, pouring is acceptable but again should be done gently and in a way as to not allow the relays to drop.
- 6)** Attached relay spreader pads and insulating pads should not be removed from the relays.
- 7)** Relays should not be exposed to any process or environment that exceeds any limits within this guide or any published specification that applies to the relay.
- 8)** Relays are hermetically sealed. Damaged to the casing or glass-to-metal seals will compromise the relays' performance and reliability.
- 9)** Never subject relays to ultrasonic cleaning environments.
- 10)** Unless otherwise specified, do not subject relays to solder reflow temperatures above 270°C, 1 minute maximum.
- 11)** Do not stack heavy object directly onto relays.
- 12)** Excessive handling of relay leads with bare hands, or exposure of the relay leads with other contaminating sources can compromise their solderability.
- 13)** Avoid exceeding 1-pound pull strength of the terminals.
- 14)** Avoid subjecting magnetic latching relays to large magnetic fields. Do not handle magnetic latching relays with magnetic holding tools.
- 15)** Avoid bending the flange, the base of the relays or bending/forming the leads in a manner which may result in deformation of the flange or base of the relays. Any such deformation, or handling, which results in visible deformations or dents to any part of the relays (including the cover) may compromise the precisely assembled internal parts of the relays, causing degradation of performance or potential permanent damage and may void the warranty.

Relay Operation

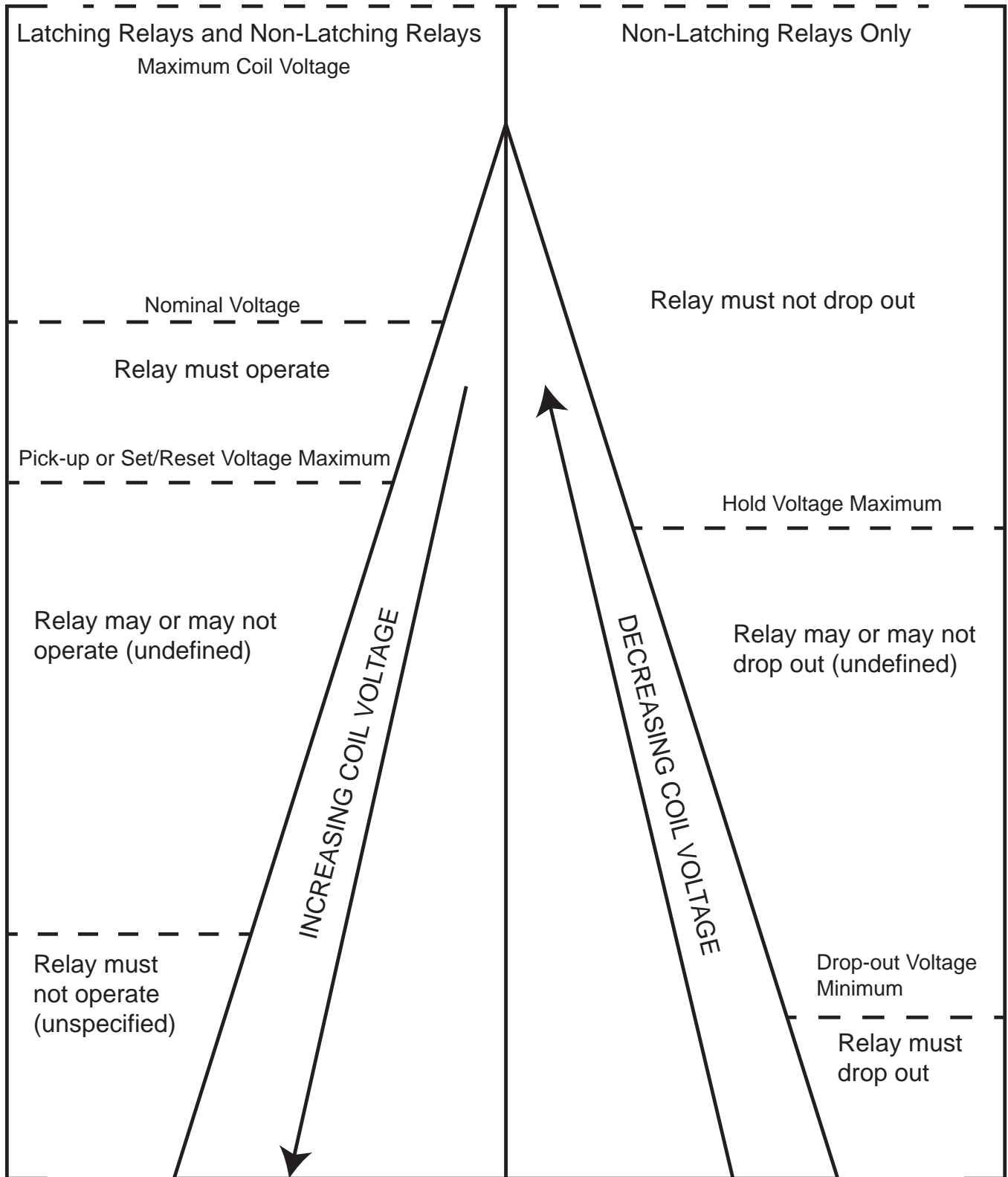

APPENDIX: Spacer Pads

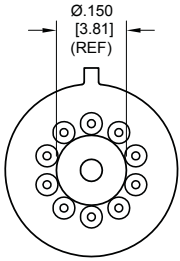
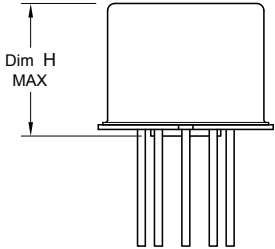
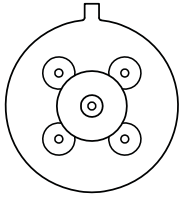
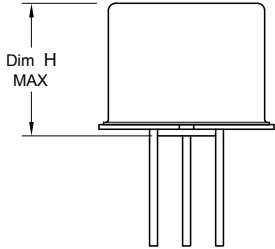
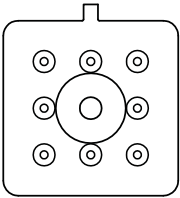
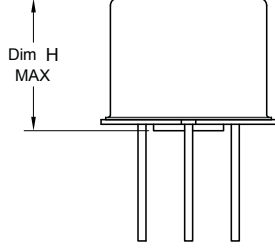
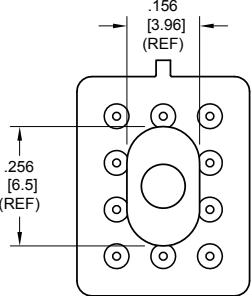
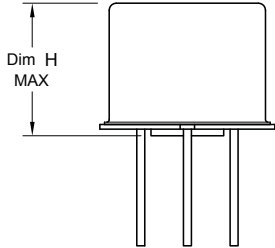
Pad designation and bottom view dimensions	Height	For use with the following:	Dim. H Max.
 <p style="text-align: center;">“M4” Pad for TO-5</p>		ER412, ER412D, ER412DD	.295 (7.49)
		712, 712D, 712TN, RF300, RF310, RF320	.300 (7.62)
		ER420, ER422D, ER420DD, 421, ER421D, ER421DD, ER422, ER422D, ER422DD, 722, 722D, RF341	.305 (7.75)
		ER431T, ER432T, ER432, ER432D, ER432DD	.400 (10.16)
		732, 732D, 732TN, RF303, RF313, RF323	.410 (10.41)
		RF312	.350 (8.89)
 <p style="text-align: center;">“M4” Pad for TO-5</p>		ER411, ER411D, ER411DD, ER411T	.295 (7.49)
		ER431, ER431D, ER431DD	.400 (10.16)
		RF311	.300 (7.62)
		RF331	.410 (10.41)
 <p style="text-align: center;">“M4” Pad for Centigrad®</p>		172, 172D	.305 (7.75)
		ER114, ER114D, ER114DD, J114, J114D, J114DD	.300 (7.62)
		ER134, ER134D, ER134DD, J134, J134D, J134DD	.400 (10.16)
		RF100	.315 (8.00)
		RF103	.420 (10.67)
 <p style="text-align: center;">“M9” Pad for Centigrad®</p>		122C, A152	.320 (8.13)
		ER116C, J116C	.300 (7.62)
		ER136C, J136C	.400 (10.16)
		RF180	.325 (8.25)
		A150	.305 (7.75)

Notes:

1. Spacer pad material: Polyester film.
2. To specify an “M4” or “M9” spacer pad, refer to the mounting variants portion of the part numbering example in the applicable datasheet.
3. Dimensions are in inches (mm).
4. Unless otherwise specified, tolerance is $\pm .010$ (.25 mm).
5. Add 10 mΩ to the contact resistance shown in the datasheet.
6. Add 0.01 oz. (0.25 g) to the weight of the relay assembly shown in the datasheet.

APPENDIX: Spreader Pads

Pad designation and bottom view dimensions	Height	For use with the following:	Dim. H Max.
<p style="text-align: center;">“M” Pad <u>5/ 6/</u></p>		ER411T, J411T, ER412, ER412D ER412DD, J412, J412D, J412DD ER412T, J412T	.388 (9.86)
		712, 712D, 712TN	.393 (9.99)
		ER431T, J431T, ER432, ER432D ER432DD, J432, J432D, J432DD ER432T, J432T	.493 (12.52)
		732, 732D, 732TN	.503 (12.78)
		ER420, J420, ER420D, J420D ER420DD, J420DD, ER421, J421 ER421D, J421D, ER421DD J422D, ER422DD, J422DD, 722	.398 (10.11)
<p style="text-align: center;">“M2” Pad <u>7/ 8/</u></p>		ER411T ER412, ER412D, ER412DD J412, J412D, J412DD	.441 (11.20)
		712, 712D	.451 (11.46)
		ER421, ER421D, ER421DD 722, 732D	.451 (11.46)
		ER431T ER432, ER432D, ER432DD	.546 (13.87)
		732, 732D	.556 (14.12)
<p style="text-align: center;">“M3” Pad <u>5/ 6/ 9/</u></p>		ER411, ER411D, ER411DD, ER411TX ER412X, ER412DX, ER412DDX ER412TX	.388 (9.86)
		712X, 712DX, 712TNX	.393 (9.99)
		ER420X, ER420DX, ER420DDX ER421X, ER421DX, ER421DDX ER422X, ER422DX ER422DDX, 722X, 722DDX	.398 (10.11)
		ER431, ER431D, ER431DD ER431TX ER432X, ER432DX, ER432DDX ER432TX	.493 (12.52)
		732X, 732DX, 732TNX	.503 (12.78)

Notes:

1. Spreader pad material: Diallyl Phthalate.
2. To specify an “M”, “M2” or “M3” spreader pad, refer to the mounting variants portion of the part number example in the applicable datasheet.
3. Dimensions are in inches (mm).
4. Unless otherwise specified, tolerance is $\pm .010$ ” (0.25 mm).
- 5/. Add 25 mΩ to the contact resistance shown in the datasheet.
- 6/. Add .01 oz. (0.25 g) to the weight of the relay assembly shown in the datasheet.
- 7/. Add 50 mΩ to the contact resistance shown in the datasheet.
- 8/. Add 0.025 oz (0.71 g) to the weight of the relay assembly shown in the datasheet.
- 9/. M3 pad to be used only when the relay has a center pin (e.g. ER411M3-12A, 722XM3-26.)

APPENDIX: Ground Pin Positions

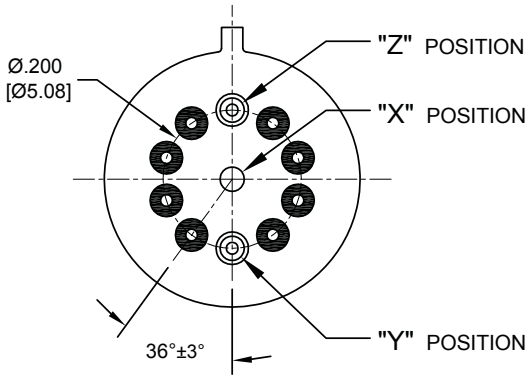

TO-5 Relays:

ER411T, ER412, ER412T, ER420, ER421, ER422, ER431T, ER432, ER432T, 712, 712TN, 400H, 400K, 400V, RF300, RF303, RF341, RF312, RF310, RF313, RF320, RF323

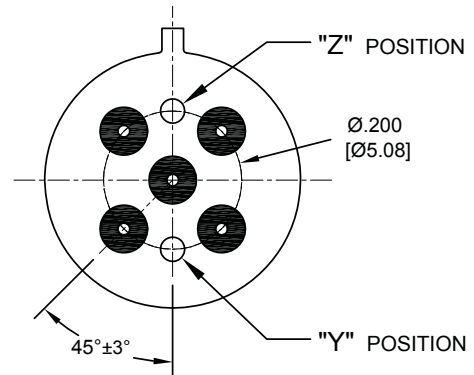

TO-5 Relays:

ER411, ER431, RF311, RF331

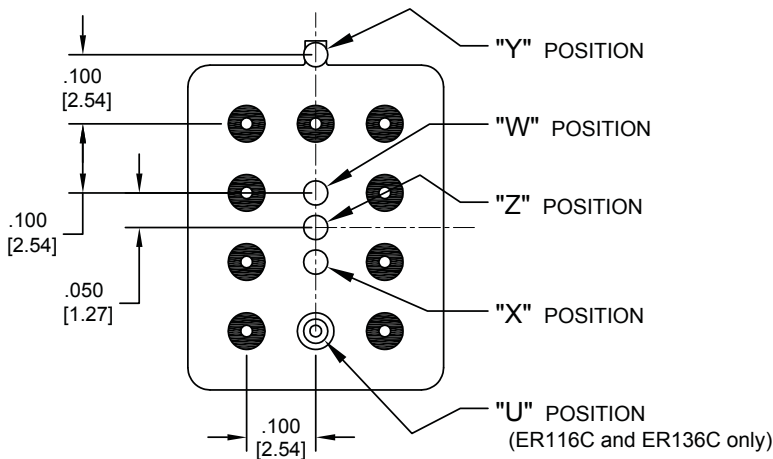

Centigrid® Relays:

RF180, ER116C, 122C, ER136C

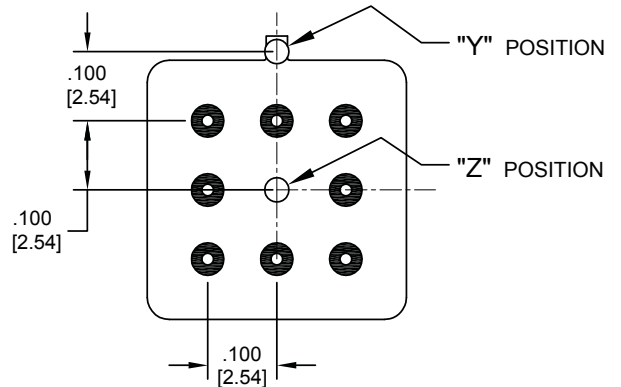

Centigrid® Relays:

RF100, RF103, ER114, ER134, 172

- Indicates ground pin position
- Indicates glass insulated lead position
- ⊙ Indicates ground pin or lead position depending on relay type

NOTES

1. Terminal views shown
2. Dimensions are in inches (mm)
3. Tolerances: $\pm .010$ ($\pm .25$) unless otherwise specified
4. Ground pin positions are within $.015$ (0.38) dia. of true position
5. Ground pin head dia., 0.035 (0.89) ref: height 0.010 (0.25) ref.
6. Lead dia. 0.017 (0.43) nom.

APPENDIX: Teledyne Relays T²R Program

Teledyne Relays' **T²R** program was developed to provide the JAN relay user an alternate means of specifying and procuring established reliability relays. The form, fit and function of a **T²R** relay is the same as that of its JAN counterpart. **T²R** program requirements differ in certain regimens/tests found in both MIL-PRF-28776 and MIL-PRF-39016 that add cost but no value to the relay.

This program parallels the military specifications in most aspects. The components that make up such a program are intricate and varied. Furthermore, there are additional options of high value for design, manufacturability and operation of high reliability assemblies. The following page presents a table that compares the 100% screening performed on JAN relays and **T²R** relays prior to shipment.

Other significant highlights of the **T²R** program include:

- Two unique screening levels
- The ability to define lead finish
- Spacer pad options which may not be available in military specifications
- Ground pin options which may not be available in military specifications
- Reduced lead time
- Reduced cost

The program is fully defined for both general product requirements and detailed product requirements in the following Teledyne Relays specifications:

TR-R-1
TR-STD-1
TR-STD-2
TR-ERL-1
TR-R-1/XXX
TR Supplement

Copies of these documents are available from Teledyne Relays. We suggest that users check with Teledyne Relays from time to time to assure that they have the latest issue.

Can't Find What You Need?

Check out our full line of relays and switches. Order literature online at <http://www.teledynereleys.com/lit-request.asp>



APPENDIX: Teledyne Relays T²R Program

INSPECTION	Screening Levels			
	<i>T²R</i> A Level 1.5%/10K Cycles	<i>T²R</i> B Level .75%/10K Cycles	JAN L Level 3%/10K Cycles	JAN M Level 1%/10K Cycles
Subgroup 1				
Screening, Internal Moisture AQL ¹	✓	✓	✓	✓
Vibration (Sinusoidal) AQL ¹			✓	
Vibration (Sinusoidal) 100%		✓		✓
Screening, Burn-In (Hybrids only)			✓	✓
Screening, Run-In (Room Temperature)	✓			
Screening, Run-In (+125°C and –65°C)		✓	✓	✓
Subgroup 2				
Coil Resistance or Coil Current	✓	✓	✓	✓
Insulation Resistance	✓	✓	✓	✓
Dielectric Withstanding Voltage	✓	✓	✓	✓
Static Contact Resistance	✓	✓	✓	✓
Pickup and Dropout or Set and Reset Voltage	✓	✓	✓	✓
Operate and Release or Set and Reset Time	✓	✓	✓	✓
Hold Voltage			✓	✓
Turn-On and Turn-Off Time (Hybrids only)	✓	✓	✓	✓
Contact Bounce Time	✓		✓	
Contact Stabilization Time		✓		✓
Turn-On Current (T Hybrids only)	✓	✓	✓	✓
Turn-On Voltage (C Hybrids only)	✓	✓	✓	✓
Turn-Off Voltage (Hybrids only)	✓	✓	✓	✓
Coil Transient Suppression (D, DD and Hybrids only)	✓	✓	✓	✓
Diode Blocking Integrity (DD only)	✓	✓	✓	✓
Zener Voltage (C Hybrid only)	✓	✓	✓	✓
Neutral Screen (Latching Relays only)	✓	✓	✓	✓
Break Before Make Verification			✓	✓
Contact Simultaneity			✓	✓
Subgroup 3				
Solderability 2 Samples per Daily Solderability Inspection Lot	✓	✓	✓	✓
Leak Test	✓	✓	✓	✓
External Visual and Mechanical Inspection 2/Lot for Dimension and Weight Check	✓	✓	✓	✓

¹ AQL = Acceptable Quality Level

Teledyne Relays: Because in deep space there is no acceptable failure rate

Teledyne Relays has a long history of supplying High Reliability relays for use in space bound vehicles. From the earliest deep space probes, such as Voyager I, now nearing 21 billion miles out in space, to the next generation of probes scheduled for the future, Teledyne Relays continues to be the preeminent supplier of Hi-Reliability relays to the space market.

Teledyne Relays Hi-Reliability Specification: TR-HIREL-1

- Eliminates the need for customers to develop and maintain specifications.
- Manufacturing and Quality Assurance requirements are fully defined and documented.
- Meets the general requirements of both ESA/SCC and NASA/GSFC documents.
- Offers options for 100% Group A screening
- Offers options for 3 levels of Lot Acceptance Testing (LAT).

Teledyne Screening Document 0-40-837

NASA approved screening regimen based on NASA/GSFC S-311-P.754

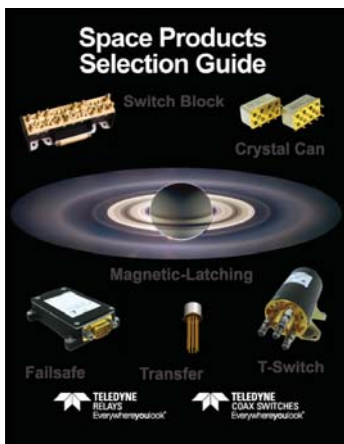

RELAY TYPES

- TO-5 Magnetic-Latching Relays
- TO-5 Non-Latching Relays
- TO-5 Magnetic-Latching, High-Shock Relays
- TO-5 Non-Latching, High-Shock Relays
- TO-5 Non-Latching, High-Vibration Relays

HI-REL SCREENING CAPABILITIES

- 100% Open Electrical Inspection
- 100% Precap Inspection
- Fully Automated Small Particle Inspection (Millipore Clean)
- Asynchronous Miss Test
- Coil Continuity
- Sine Vibration
- Random Vibration
- High/Low Run In (Miss Test) $-65^{\circ}\text{C} \pm 125^{\circ}\text{C}$
- Radiographic Inspection
- Mechanical Shock Test
- Thermal Shock Test
- Acceleration
- Radiographic Inspection (X-ray)
- Mechanical Shock Test
- Thermal Shock Test
- Acceleration
- Load Banks for a Variety of Life Test Load
- Serialized Printed Electrical Data
- Continuous Life Testing
- Environmental Testing
- Vertical Integration

For information or answers to your questions, please visit our website.

HEADQUARTERS
12525 Daphne Ave.
Hawthorne, CA 90250
Phone: (323) 777-0077 or (800) 284-7007
Fax: (323) 241-1287
E-mail: relays@teledyne.com

www.teledynerelays.com
(800) 284-7007

EUROPE
9-13 Napier Road
Wardpark North
Cumbernauld G68 OEF
Scotland UK
Phone: +44 (0) 1236 453 124
Fax: +44 (0) 1236 780 651
E-mail: sales_europe@teledyne.com

www.teledyne-europe.com
+44 (0) 1236 453 124



TELEDYNE
RELAYS
Everywhereyoulook™

Компания «Океан Электроники» предлагает заключение долгосрочных отношений при поставках импортных электронных компонентов на взаимовыгодных условиях!

Наши преимущества:

- Поставка оригинальных импортных электронных компонентов напрямую с производств Америки, Европы и Азии, а так же с крупнейших складов мира;
- Широкая линейка поставок активных и пассивных импортных электронных компонентов (более 30 млн. наименований);
- Поставка сложных, дефицитных, либо снятых с производства позиций;
- Оперативные сроки поставки под заказ (от 5 рабочих дней);
- Экспресс доставка в любую точку России;
- Помощь Конструкторского Отдела и консультации квалифицированных инженеров;
- Техническая поддержка проекта, помощь в подборе аналогов, поставка прототипов;
- Поставка электронных компонентов под контролем ВП;
- Система менеджмента качества сертифицирована по Международному стандарту ISO 9001;
- При необходимости вся продукция военного и аэрокосмического назначения проходит испытания и сертификацию в лаборатории (по согласованию с заказчиком);
- Поставка специализированных компонентов военного и аэрокосмического уровня качества (Xilinx, Altera, Analog Devices, Intersil, Interpoint, Microsemi, Actel, Aeroflex, Peregrine, VPT, Syfer, Eurofarad, Texas Instruments, MS Kennedy, Miteq, Cobham, E2V, MA-COM, Hittite, Mini-Circuits, General Dynamics и др.);

Компания «Океан Электроники» является официальным дистрибьютором и эксклюзивным представителем в России одного из крупнейших производителей разъемов военного и аэрокосмического назначения «**JONHON**», а так же официальным дистрибьютором и эксклюзивным представителем в России производителя высокотехнологичных и надежных решений для передачи СВЧ сигналов «**FORSTAR**».



JONHON

«**JONHON**» (основан в 1970 г.)

Разъемы специального, военного и аэрокосмического назначения:

(Применяются в военной, авиационной, аэрокосмической, морской, железнодорожной, горно- и нефтедобывающей отраслях промышленности)

«**FORSTAR**» (основан в 1998 г.)

ВЧ соединители, коаксиальные кабели,
кабельные сборки и микроволновые компоненты:

(Применяются в телекоммуникациях гражданского и специального назначения, в средствах связи, РЛС, а так же военной, авиационной и аэрокосмической отраслях промышленности).



Телефон: 8 (812) 309-75-97 (многоканальный)

Факс: 8 (812) 320-03-32

Электронная почта: ocean@oceanchips.ru

Web: <http://oceanchips.ru/>

Адрес: 198099, г. Санкт-Петербург, ул. Калинина, д. 2, корп. 4, лит. А