

Plateau Head Knob-type Selector Switch A3US

Easy connector enables less assembly and less wiring

- 50 mm body length.
- Highly reliable Major Omron basic switch, SS model built in.
- Possible cross over wiring on circuit construction.
- Easy one push to connect the Operation and Switch Units.

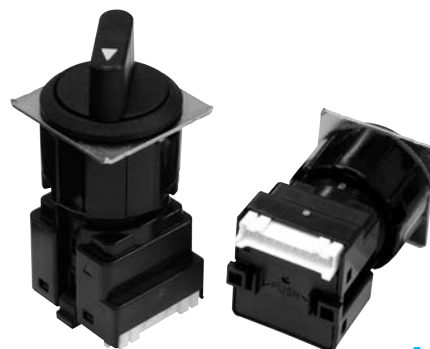

NEW

Model Number Structure

Model Number Legend....For information on combinations, refer to Ordering Information.

A3US-S⁽¹⁾-⁽²⁾M-AC⁽³⁾

(1) Flange Color

Symbol	Color
B	Black
M	Metallic

(2) Number of Notches and Reset Method

Symbol	Number of notches	Reset method
2M	2	Manual
3M	3	

(3) Degree of Protection

Symbol	Protection
Blank	IP40
5	IP67 (Oil-proof type)

Ordering Information

Switches

Degree of Protection: IP40

Flange Color: Black

Type	No. of notches	Reset method	Output	Model	Selector color
Plateau Head Knob-type Selector Switch	2	Manual	SPDT	A3US-SB-2M-AC	Black
	3		DPDT	A3US-SB-3M-AC	

Flange Color: Metallic

Type	No. of notches	Reset method	Output	Model	Selector color
Plateau Head Knob-type Selector Switch	2	Manual	SPDT	A3US-SM-2M-AC	Black
	3		DPDT	A3US-SM-3M-AC	

Degree of Protection: IP65 (Oil-proof Type)

Flange Color: Black

Type	No. of notches	Reset method	Output	Model	Selector color
Plateau Head Knob-type Selector Switch	2	Manual	SPDT	A3US-SB-2M-AC5	Black
	3		DPDT	A3US-SB-3M-AC5	

Flange Color: Metallic

Type	No. of notches	Reset method	Output	Model	Selector color
Plateau Head Knob-type Selector Switch	2	Manual	SPDT	A3US-SM-2M-AC5	Black
	3		DPDT	A3US-SM-3M-AC5	

Accessories and Tools (Sold Separately)

The accessories and tools are the same as those for the A3U. Refer to the A3U datasheet.

A3US

Specifications

Approved Standard Ratings

Certification Authority	UL (See Note: 1 and Note: 2)	CSA (See Note: 1 and Note: 2)	TÜV (See Note: 3)
Certification no.	UL508 CSA C22.2 No.14	CSA C22.2 No. 14	EN60947-5-1
Rating	30 VDC 0.1 A	30 VDC 0.1 A	12 30 VDC 0.1 A
File no.	E41515	2650068	J50236157

Note: 1. Only Switch Blocks are recognized by UL/CSA. (Surrounding air Temperature: 55 °C)

Note: 2. Please use the power supply specified in UL/CSA class 2.

Note: 3. Use 4A 250V as short-circuit protective device when using under EN-compliant rating standard (IEC60127-2 SS1).

Ratings

Contacts

30 VDC, 0.1 A (Resistive load)

Minimum applicable load: 1 mA at 5 VDC

Rated values are obtained from tests conducted under the following conditions.

1. Load: Resistive load
2. Mounting conditions: No vibration and no shock
3. Temperature: 20 ± 2 °C
4. Operating frequency: 20 operations/min

Characteristics

Item		Knob-type Selector Switch
Allowable operating frequency	Mechanical	30 operations/minute max.
	Electrical	30 operations/minute max.
Insulation resistance		100 MΩ min. (at 500 VDC)
Contact resistance		250 mΩ max. (initial value)
Dielectric strength	Between terminals of same polarity	500 VAC, 50/60 Hz for 1 minute
	Between each terminal and ground	1,500 VAC, 50/60 Hz for 1 minute
Vibration resistance	Malfunction	10 to 55 Hz, 1.5-mm double amplitude (malfunction within 1 ms)
Shock resistance	Malfunction	300 m/s ² max. (malfunction within 1 ms)
Durability	Mechanical	250,000 operations min.
	Electrical	100,000 operations min.
Connector holding force		40 N max.
Rated insulation voltage (Ui)		30 V (EN60947-5-1)
Electric shock protection class		Class II
Degree of contamination		3 (EN60947-5-1)
Impulse withstand voltage	Between terminals of same polarity	800 V (EN60947-5-1)
	Between terminals of different polarity	
	Between each terminal and ground	
Conditional short-circuit current		100 A (EN60947-5-1)
Conventional enclosed thermal current (Ithe)		0.1 A (EN60947-5-1)
Weight		Approx. 30 g
Degree of protection		IP40, IP65 (Oil-proof type)
Ambient operating temperature		-20 °C to 70 °C (with no icing or condensation)
Ambient operating humidity		35 % to 85 % RH
Ambient storage temperature		-40 °C to 70 °C (with no icing or condensation)
Ambient storage humidity		35 % to 85 % RH

Operating Characteristics

Features	A3US
Total travel force (TTF) max.	0.34 N·m
Resetting force (RF) max.	0.34 N·m
Total travel (TT)	2 notches: Approx. 90 ° 3 notches: Approx. 45 °

Circuit Diagram

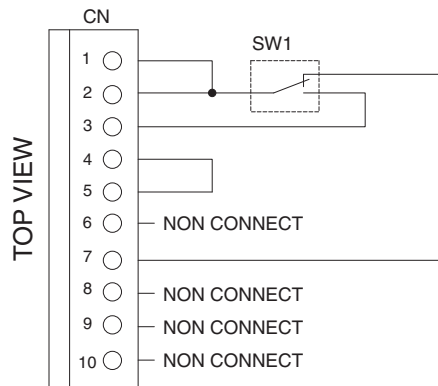

- Note: 1.** This circuit is for a Two-notch Switch.
Note: 2. Mount SW2 for a Three-notch Switch.

Dimensions

A3US

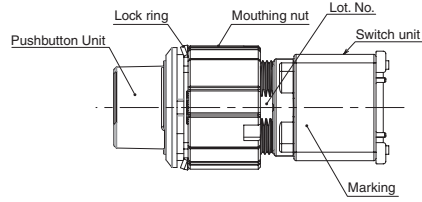
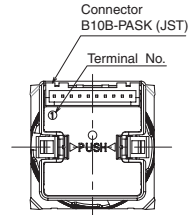
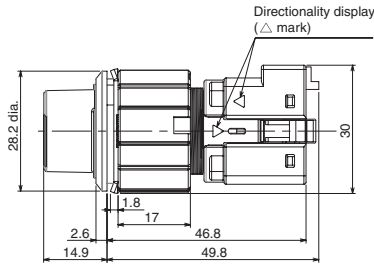
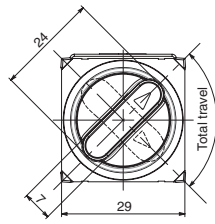

Safety Precautions

Refer to Safety Precautions for All Pushbutton Switches/Indicators.

Precautions for Safe Use

- Do not disassemble or modify the Switch under any circumstances. Doing so may cause malfunction.
- Do not drop or subject the Switch to extreme shock or force. This may prevent the Switch from functioning to its full capability.
- The durability of the Switch varies considerably depending on the switching conditions. Always test the switch under actual working conditions before application and use the Switch only for the number of switching operations allowed.
- Do not allow the load current to exceed the rated value. This may damage or burn out the Switch.
- Refer to the Circuit Diagram and make sure to wire correctly. Only the terminal (1) is printed and the right end of the terminal is read as (10).

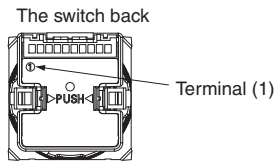

- Do not use the Switch in locations where explosive or flammable gases or liquid may be present or scattered. The electric arc or the heat caused by switching contacts may trigger off a fire or explosion.
- Do not use the Switch in locations where toxic gases, such as H₂S, SO₂, NH₃, HNO₃, and Cl₂, may be present, or in locations subject to high temperature or humidity. Doing so may damage the Switch due to contact failure or corrosion.
- Do not let the Switch submerged in oil or water, or use in locations continuously subject to splashes of oil/water. Doing so may result in oil or water entering the Switch.
- Do not use the Switch in the following locations;
 - subject to severe temperature changes.
 - subject to high humidity or condensation.
 - subject to severe vibration or shock.
 - where direct rays of the sun strike.
 - where sea breeze may be present.
- When the Switch is exposed to the environment that are not required, or stored in locations where condensation presents, or damaged by fall out, or stored for more than an year, please test it under the usage conditions before application.
- Mounting and Removing the Switch

1. Insert the Operation Unit from the front of the panel, insert the Lock Ring and Mounting Nut from the back of the panel, and tighten the Mounting Nut. Then, attach the Switch Unit to the Operation Unit.
2. For a Switch with IP65 protection, make sure that the rubber washer is in place between the Operation Unit and the panel.
3. Align the Lock Ring with the slot on the case and insert it so that the edge is flush with the panel.
4. Tighten the Mounting Nut to between 0.98 and 1.96 N·m.
5. To mount the Switch Unit to the Operation Unit, align the the triangle marks on the Operation Unit and Switch Unit and insert the Switch Unit until it locks securely in place.
6. The push marks on both sides are only for removal. Do not push them when you insert the Switch Unit into the Pushbutton Unit. Otherwise, the Pushbutton Unit will be hooked incorrectly.
7. To remove the Switch, press the levers on both sides in the direction indicated by PUSH marks. Applying too much force may damage the Switch.
8. Remove the Switch Unit before you remove the Pushbutton Unit. If you loosen the mounting nut while the Switch Unit is still attached, you will damage the Pushbutton Unit.

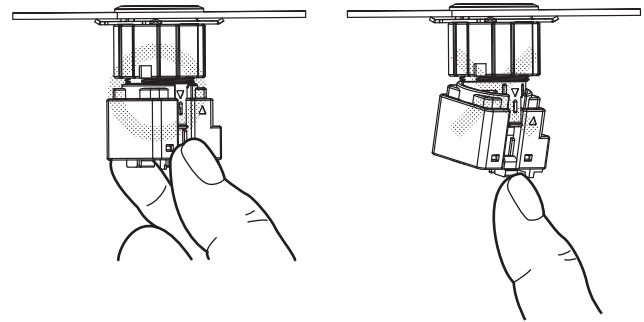
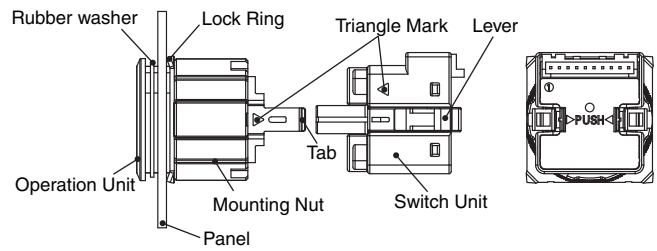

Wiring

1. Do not wire the Switch while power is being supplied. Doing so may result in electric shock.
2. Make sure to insert the connector to the end. This may prevent the Switch from functioning to its full capability.
3. Do not subject the Switch to an excessive force when wiring. Fix the cables first to avoid the connector and cables from being pulled with. Otherwise, the connector may be disassembled or damaged, resulting in the contact damages.

Too much tension to the cables.

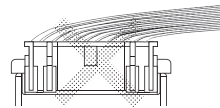

Appropriate force to the cables.

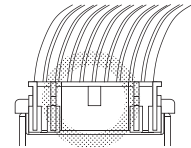

4. Refer to specification of each connector or catalogue for details of installing or wiring the terminal side of the connector.

Recommended connector;

Manufacture	Name	Model	Applicable lead wire
J.S.T. Mfg Co.	Contact	SPHD-002T-P0.5	AWG#28 to 24
		SPHD-001T-P0.5	AWG#26 to 22
	Housing	PAP-10V-S	AWG#28 to 22

- Choose the applicable contact to the wire.

Precautions for Correct Use

- Operating Environment
 1. This Switch is intended for indoor use only. Do not use the Switch outdoors.
 2. Do not set the Switch in locations where powders, mud, or any other substances may be piled, or subject to any splashes of oil or water. Always test the switch under actual working conditions before application.
 3. The Switches with oil-resistant IP65 protection use NBR rubber and are resistant to general cutting oils and cooling oils. Some special oils, however, cannot be used with these Switches. Contact your OMRON representative for details.
- Mounting panels
 1. Set mounting panel thickness to be 0.8 to 3.2 mm.
 2. The panel dimension is set as below;

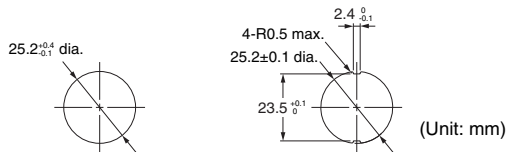

Cutout Hole for Positioning and to Prevent Switch Rotation

- The value in () indicated below is the minimum value suggested for easy detaching of the Switch.
- Minimum panel pitch is 30/32 mm. Consider the flexibility and allowance of detaching and wiring, set the pitch to the appropriate value.
- Leave some spaces for a finger between panels, so as to pinch the levers.
- Place the panels in the same direction. Do not set the connectors face to face for easy removal.

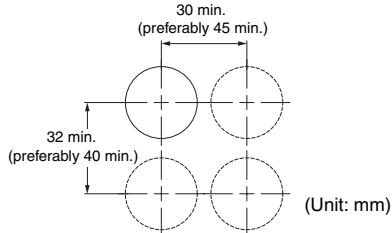

Wrong setup :

Connectors are too closely placed.

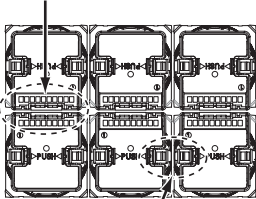

Levers are too close and cannot be pushed.

Right setup :

Same direction

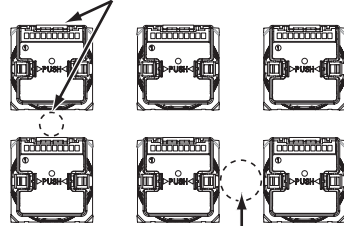

Some rooms for fingers to push.

Terms and Conditions Agreement

Read and understand this catalog.

Please read and understand this catalog before purchasing the products. Please consult your OMRON representative if you have any questions or comments.

Warranties.

- (a) Exclusive Warranty. Omron's exclusive warranty is that the Products will be free from defects in materials and workmanship for a period of twelve months from the date of sale by Omron (or such other period expressed in writing by Omron). Omron disclaims all other warranties, express or implied.
- (b) Limitations. OMRON MAKES NO WARRANTY OR REPRESENTATION, EXPRESS OR IMPLIED, ABOUT NON-INFRINGEMENT, MERCHANTABILITY OR FITNESS FOR A PARTICULAR PURPOSE OF THE PRODUCTS. BUYER ACKNOWLEDGES THAT IT ALONE HAS DETERMINED THAT THE PRODUCTS WILL SUITABLY MEET THE REQUIREMENTS OF THEIR INTENDED USE.

Omron further disclaims all warranties and responsibility of any type for claims or expenses based on infringement by the Products or otherwise of any intellectual property right. (c) Buyer Remedy. Omron's sole obligation hereunder shall be, at Omron's election, to (i) replace (in the form originally shipped with Buyer responsible for labor charges for removal or replacement thereof) the non-complying Product, (ii) repair the non-complying Product, or (iii) repay or credit Buyer an amount equal to the purchase price of the non-complying Product; provided that in no event shall Omron be responsible for warranty, repair, indemnity or any other claims or expenses regarding the Products unless Omron's analysis confirms that the Products were properly handled, stored, installed and maintained and not subject to contamination, abuse, misuse or inappropriate modification. Return of any Products by Buyer must be approved in writing by Omron before shipment. Omron Companies shall not be liable for the suitability or unsuitability or the results from the use of Products in combination with any electrical or electronic components, circuits, system assemblies or any other materials or substances or environments. Any advice, recommendations or information given orally or in writing, are not to be construed as an amendment or addition to the above warranty.

See <http://www.omron.com/global/> or contact your Omron representative for published information.

Limitation on Liability; Etc.

OMRON COMPANIES SHALL NOT BE LIABLE FOR SPECIAL, INDIRECT, INCIDENTAL, OR CONSEQUENTIAL DAMAGES, LOSS OF PROFITS OR PRODUCTION OR COMMERCIAL LOSS IN ANY WAY CONNECTED WITH THE PRODUCTS, WHETHER SUCH CLAIM IS BASED IN CONTRACT, WARRANTY, NEGLIGENCE OR STRICT LIABILITY.

Further, in no event shall liability of Omron Companies exceed the individual price of the Product on which liability is asserted.

Suitability of Use.

Omron Companies shall not be responsible for conformity with any standards, codes or regulations which apply to the combination of the Product in the Buyer's application or use of the Product. At Buyer's request, Omron will provide applicable third party certification documents identifying ratings and limitations of use which apply to the Product. This information by itself is not sufficient for a complete determination of the suitability of the Product in combination with the end product, machine, system, or other application or use. Buyer shall be solely responsible for determining appropriateness of the particular Product with respect to Buyer's application, product or system. Buyer shall take application responsibility in all cases.

NEVER USE THE PRODUCT FOR AN APPLICATION INVOLVING SERIOUS RISK TO LIFE OR PROPERTY OR IN LARGE QUANTITIES WITHOUT ENSURING THAT THE SYSTEM AS A WHOLE HAS BEEN DESIGNED TO ADDRESS THE RISKS, AND THAT THE OMRON PRODUCT(S) IS PROPERLY RATED AND INSTALLED FOR THE INTENDED USE WITHIN THE OVERALL EQUIPMENT OR SYSTEM.

Programmable Products.

Omron Companies shall not be responsible for the user's programming of a programmable Product, or any consequence thereof.

Performance Data.

Data presented in Omron Company websites, catalogs and other materials is provided as a guide for the user in determining suitability and does not constitute a warranty. It may represent the result of Omron's test conditions, and the user must correlate it to actual application requirements. Actual performance is subject to the Omron's Warranty and Limitations of Liability.

Change in Specifications.

Product specifications and accessories may be changed at any time based on improvements and other reasons. It is our practice to change part numbers when published ratings or features are changed, or when significant construction changes are made. However, some specifications of the Product may be changed without any notice. When in doubt, special part numbers may be assigned to fix or establish key specifications for your application. Please consult with your Omron's representative at any time to confirm actual specifications of purchased Product.

Errors and Omissions.

Information presented by Omron Companies has been checked and is believed to be accurate; however, no responsibility is assumed for clerical, typographical or proofreading errors or omissions.

OMRON Corporation Industrial Automation Company

Tokyo, JAPAN

Contact: www.ia.omron.com

Regional Headquarters

OMRON EUROPE B.V.

Wegalaan 67-69, 2132 JD Hoofddorp
The Netherlands
Tel: (31)2356-81-300/Fax: (31)2356-81-388

OMRON ELECTRONICS LLC

2895 Greenspoint Parkway, Suite 200
Hoffman Estates, IL 60169 U.S.A
Tel: (1) 847-843-7900/Fax: (1) 847-843-7787

OMRON ASIA PACIFIC PTE. LTD.

No. 438A Alexandra Road # 05-05/08 (Lobby 2),
Alexandra Technopark,
Singapore 119967
Tel: (65) 6835-3011/Fax: (65) 6835-2711

OMRON (CHINA) CO., LTD.

Room 2211, Bank of China Tower,
200 Yin Cheng Zhong Road,
PuDong New Area, Shanghai, 200120, China
Tel: (86) 21-5037-2222/Fax: (86) 21-5037-2200

Authorized Distributor:

© OMRON Corporation 2013-2015 All Rights Reserved.
In the interest of product improvement,
specifications are subject to change without notice.

CSM_4_1_0217
Cat. No. **A225-E1-02**

Printed in Japan
0115 (0413)

Mouser Electronics

Authorized Distributor

Click to View Pricing, Inventory, Delivery & Lifecycle Information:

Omron:

[A3US-SB-2M-AC](#)

Компания «Океан Электроники» предлагает заключение долгосрочных отношений при поставках импортных электронных компонентов на взаимовыгодных условиях!

Наши преимущества:

- Поставка оригинальных импортных электронных компонентов напрямую с производств Америки, Европы и Азии, а так же с крупнейших складов мира;
- Широкая линейка поставок активных и пассивных импортных электронных компонентов (более 30 млн. наименований);
- Поставка сложных, дефицитных, либо снятых с производства позиций;
- Оперативные сроки поставки под заказ (от 5 рабочих дней);
- Экспресс доставка в любую точку России;
- Помощь Конструкторского Отдела и консультации квалифицированных инженеров;
- Техническая поддержка проекта, помощь в подборе аналогов, поставка прототипов;
- Поставка электронных компонентов под контролем ВП;
- Система менеджмента качества сертифицирована по Международному стандарту ISO 9001;
- При необходимости вся продукция военного и аэрокосмического назначения проходит испытания и сертификацию в лаборатории (по согласованию с заказчиком);
- Поставка специализированных компонентов военного и аэрокосмического уровня качества (Xilinx, Altera, Analog Devices, Intersil, Interpoint, Microsemi, Actel, Aeroflex, Peregrine, VPT, Syfer, Eurofarad, Texas Instruments, MS Kennedy, Miteq, Cobham, E2V, MA-COM, Hittite, Mini-Circuits, General Dynamics и др.);

Компания «Океан Электроники» является официальным дистрибьютором и эксклюзивным представителем в России одного из крупнейших производителей разъемов военного и аэрокосмического назначения «JONHON», а так же официальным дистрибьютором и эксклюзивным представителем в России производителя высокотехнологичных и надежных решений для передачи СВЧ сигналов «FORSTAR».



JONHON

«JONHON» (основан в 1970 г.)

Разъемы специального, военного и аэрокосмического назначения:

(Применяются в военной, авиационной, аэрокосмической, морской, железнодорожной, горно- и нефтедобывающей отраслях промышленности)

«FORSTAR» (основан в 1998 г.)

ВЧ соединители, коаксиальные кабели, кабельные сборки и микроволновые компоненты:

(Применяются в телекоммуникациях гражданского и специального назначения, в средствах связи, РЛС, а так же военной, авиационной и аэрокосмической отраслях промышленности).



Телефон: 8 (812) 309-75-97 (многоканальный)

Факс: 8 (812) 320-03-32

Электронная почта: ocean@oceanchips.ru

Web: <http://oceanchips.ru/>

Адрес: 198099, г. Санкт-Петербург, ул. Калинина, д. 2, корп. 4, лит. А