

Click [here](#) for production status of specific part numbers.

# MAX77680/MAX77681 Evaluation Kit

Evaluates: MAX77680/MAX77681

## General Description

The MAX77680/MAX77681 evaluation kit (EV kit) is a fully assembled and tested printed circuit board (PCB) that demonstrates the MAX77680/MAX77681. The EV kit allows for easy evaluation of the MAX77680/MAX77681 resources, including the SIMO and I<sup>2</sup>C interface.

Windows<sup>®</sup>-based software provides a user-friendly graphical interface as well as a detailed register-based interface to exercise the features of the MAX77680/MAX77681.

Ordering Information appears at end of data sheet.

## Benefits and Features

- Easy to Use
  - GUI Drives I<sup>2</sup>C Interface
  - Fully Assembled and Tested
- Emulates System Loading
  - On-Board Electronic Load for SIMO Buck-Boost Outputs
  - Electronic Load has Steady-State, Transient, and Random Modes
- Evaluates Both Push-Button and Slider-Switch On-Key Options

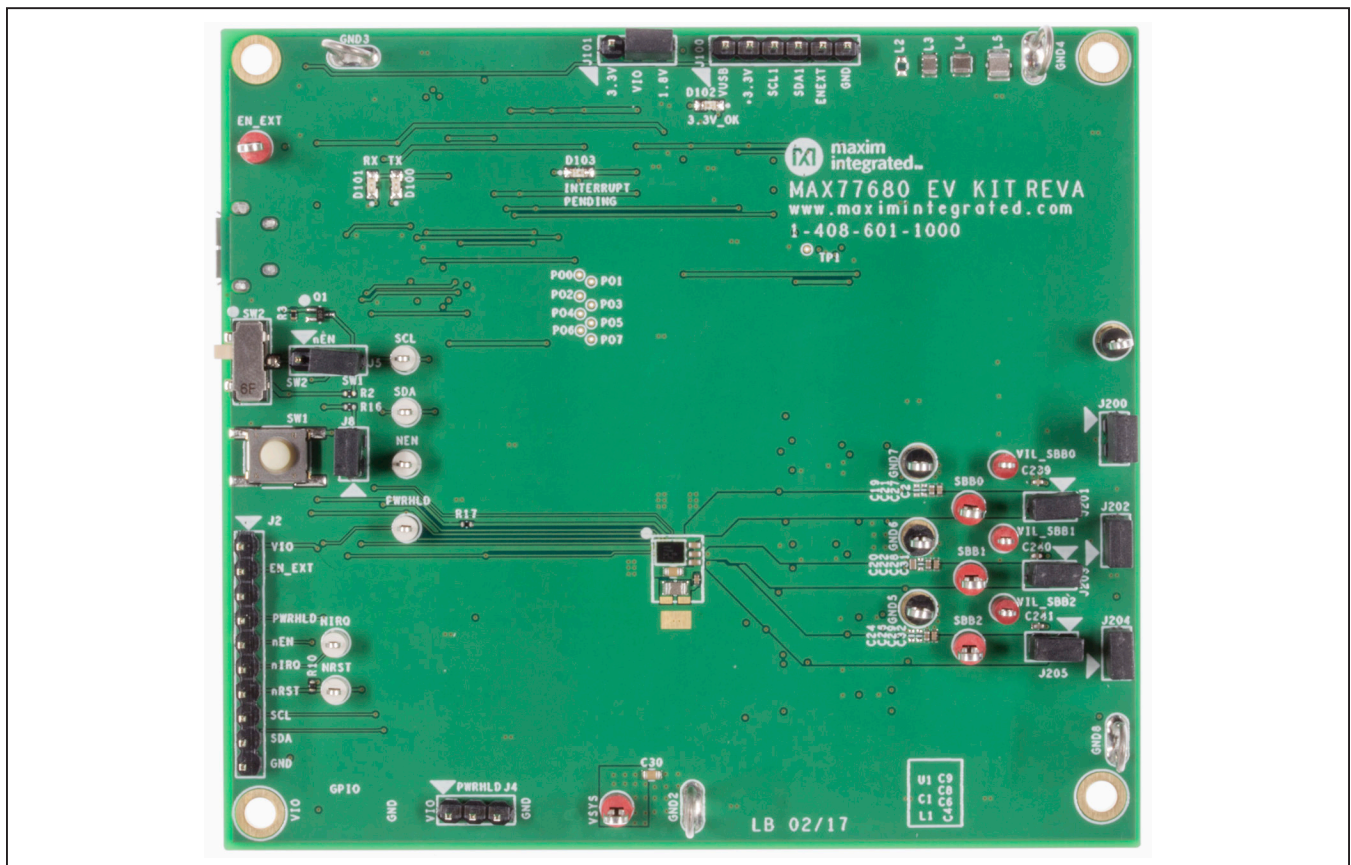

Figure 1. MAX77680/MAX77681 EV Kit Photo

Windows is a registered trademark and registered service mark of Microsoft Corporation.



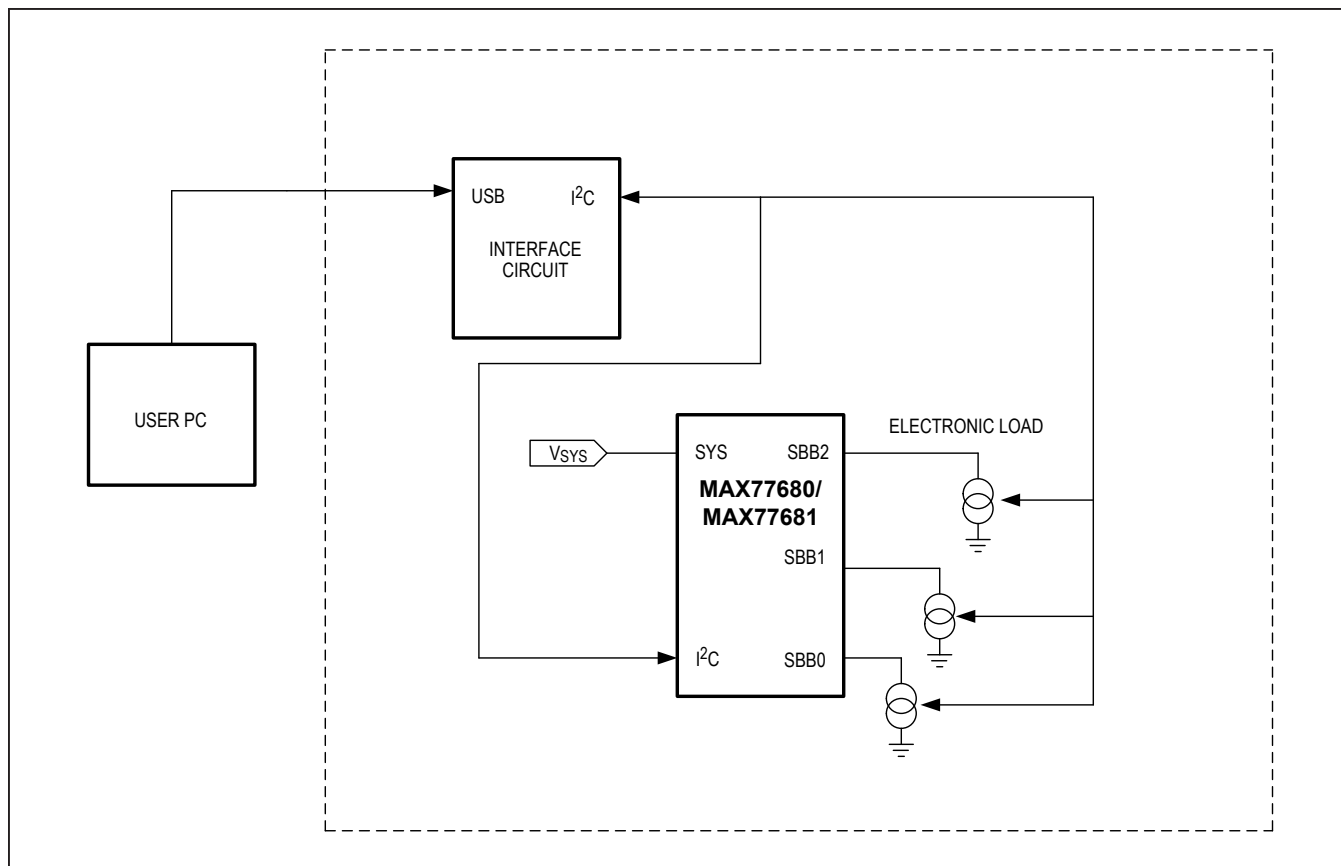

Figure 2. MAX77680/MAX77681 EV Kit Block Diagram

MAX77680/MAX77681  
Evaluation Kit

Evaluates: MAX77680/MAX77681

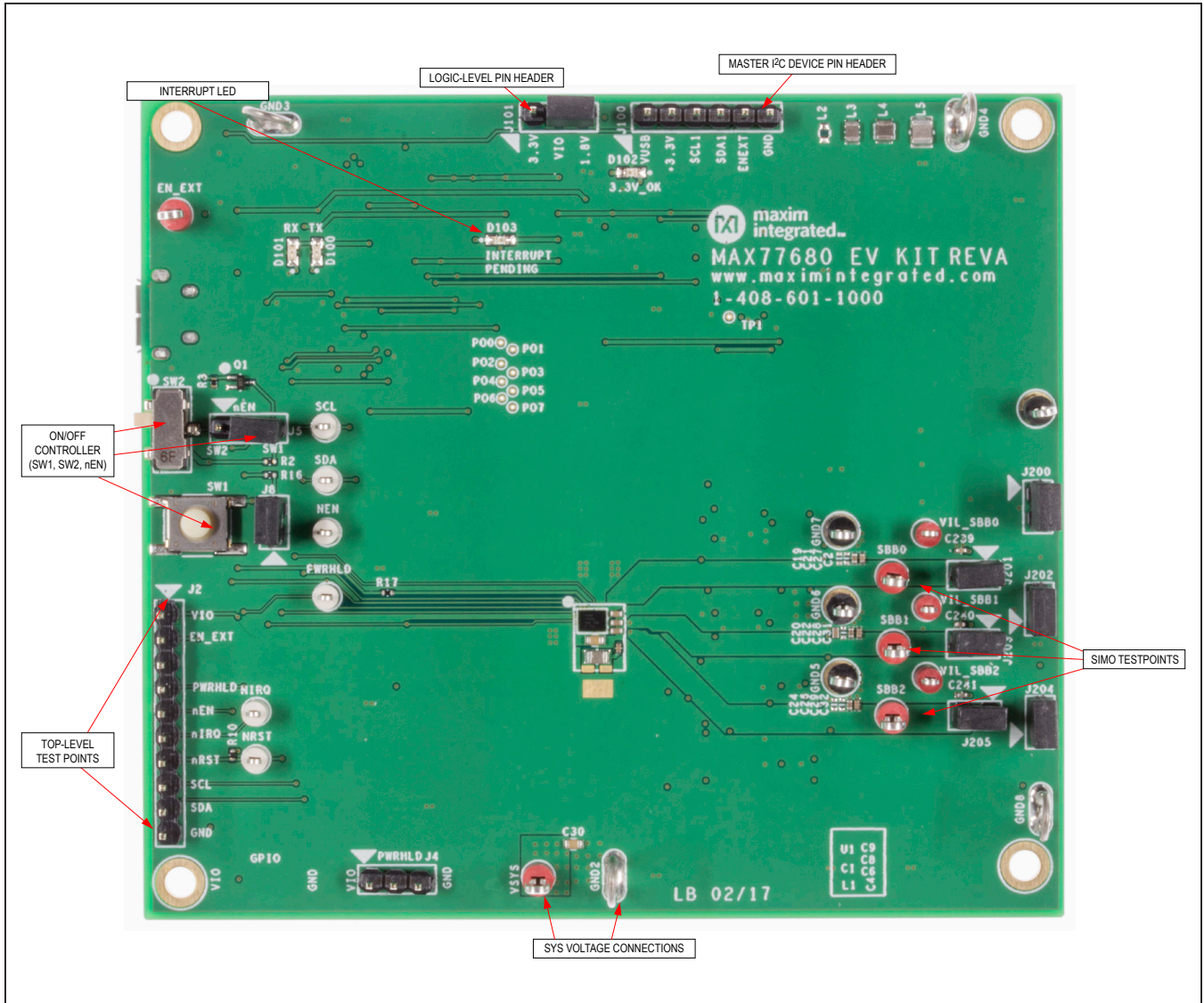

Figure 3. MAX77680/MAX77681 EV Kit Top View

MAX77680/MAX77681  
Evaluation Kit

Evaluates: MAX77680/MAX77681

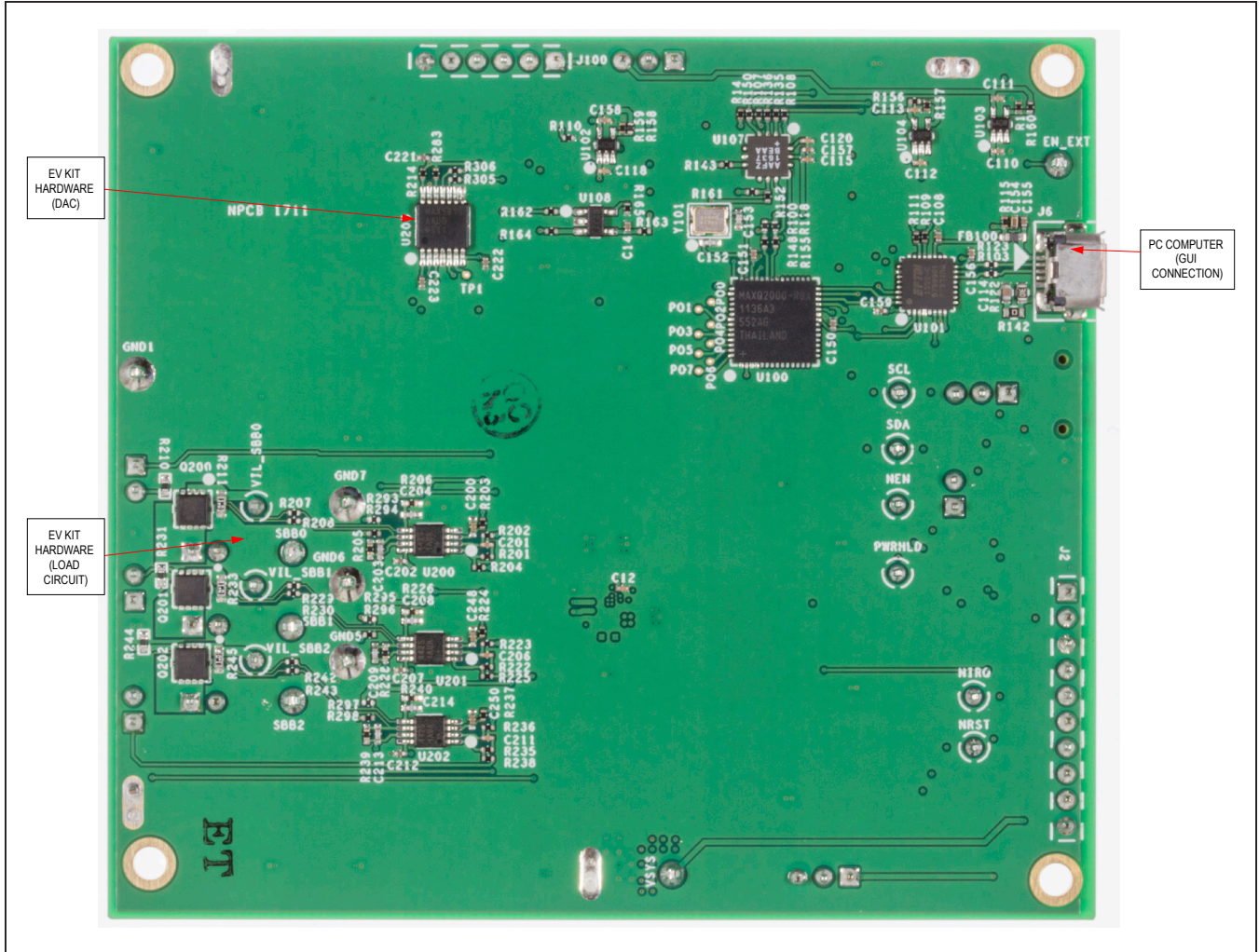

Figure 4. MAX77680/MAX77681 EV Kit Bottom View

## Quick Start

Follow this procedure to familiarize yourself with the EV kit.

**Note:** In the following sections, software-related items are identified by bolding. Text in **bold** refers to items directly from the EV kit software. Text in **bold and underlined** refers to items from the Windows operating system.

### Required Equipment

- MAX77680/MAX77681 EV kit
- Windows-based PC
- Power supply
- Ammeter
- DVM
- Micro-USB cable
- GUI

### Procedure

The EV kit is fully assembled and tested. Follow the steps below to verify board operation.

- 1) Visit the product webpage at [www.maximintegrated.com/max77680evkit](http://www.maximintegrated.com/max77680evkit) and navigate to *Design Resources* to download the latest version of the EV kit software. Save the EV kit software to a temporary folder and decompress the ZIP file.

- 2) Install all shunts as recommended in [Table 1](#).
- 3) Connect a Micro-B USB cable between the EV kit's J6 and your Windows-based PC.
- 4) Apply a 3.7V supply (set for 100mA current limit) through an ammeter (set for 10mA range) across the SYS and GND2 terminals of the EV kit. Turn the supply on.
- 5) Open the GUI and press the **Connect** button in the upper left corner. Wait for the device to respond, and in the **Synchronize** window, press the **Read and close** button.
- 6) Press the on-key (SW1) for approximately 1 second, then release the on-key.
- 7) Confirm with the ammeter that the quiescent current is approximately 37.5µA.
- 8) Connect a DVM to SBB0, SBB1, and SBB2. For the MAX77680A, 1.8V, 1.2V, and 3.3V appear, respectively. For the MAX77681A, 1.8V, 3.3V, and 5.0V appear, respectively.

This concludes the Quick Start procedure. Users are now encouraged to explore the device and its register settings with the GUI. During general device evaluation, set the ammeter range to greater than or equal to 1A to minimize the impact of its series resistance.

For more information on the GUI, see the [Software](#) section.

**Table 1. Default Shunt Positions and Jumper Descriptions**

REFERENCE DESIGNATOR	DEFAULT POSITION	FUNCTION
J100	N/A	Do not connect shunts to J100.
J101	1-2	<b>1-2:</b> Connects a V <sub>IO</sub> to the 3.3V EV kit logic rail. <b>3-4:</b> Connects a V <sub>IO</sub> to the 1.8V EV kit logic rail.
J200	1-2	<b>1-2:</b> Connects the U200 amplifier to the gate of the Q200 load FET.
J201	1-2	<b>1-2:</b> Connects SBB0 to load cell.
J202	1-2	<b>1-2:</b> Connects the U202 amplifier to the gate of the Q202 load FET.
J203	1-2	<b>1-2:</b> Connects SBB1 to load cell.
J204	1-2	<b>1-2:</b> Connects the U204 amplifier to the gate of the Q204 load FET.
J205	1-2	<b>1-2:</b> Connects SBB2 to load cell.
J2	N/A	Do not connect shunts to J2.
J4	1-2	<b>1-2:</b> Connects PWRHLD to V <sub>IO</sub> . <b>2-3:</b> Connects PWRHLD to GND.
J5	2-3	<b>1-2:</b> Connects nEN to SW2. <b>2-3:</b> Connects nEN to SW1.
J6	N/A	USB-Micro adapter for communications to a user PC (and use the GUI).
J8	1-2	<b>1-2:</b> Connects nRST to PWRHLD through a 150Ω resistor.

## EV Kit Features

### On-Key Options

For applications that require the IC to enable with a user-interactable switch, the EV kit comes with two common types: the push-button (momentary) and the slide-switch (persistent). The active-low enable pin (nEN) has an internal pullup resistor. Select between either switch with the jumper J5. Refer to the data sheet for more information on configuring the IC for momentary or persistent switches.

### Electronic Load

The EV kit comes with an electronic load that allows the user to easily evaluate the SIMO regulators. An on-board DAC and op-amp configuration set the load current through I<sup>2</sup>C, and J201, J203, and J205 connects the load to the output of SBB0, SBB1, and SBB2, respectively. Emulate SYS loading by removing J201 and connecting pin 1 of the header to VSYS with a wire. To exercise the load transient response of a regulator, remove J200, J202, or J204 and connect a signal generator to the gate of the load MOSFET (pin 2 of the header). Drive the MOSFET gate with a signal between ~1V (off) and ~3V (fully on) to apply transients to the output of the regulator (assuming J201, J203, J205, or J207 is installed). Note that there is a 1Ω sense resistor that has test point access (called VIL\_SBBx) that allows for a 1:1 conversion of load current to voltage.

## Software

The graphical user interface (GUI) software allows for quick, easy, and thorough evaluation of the MAX77680/MAX77681.

The GUI is designed to have individual tabs for each functional block of the device (**MAX77680/MAX77681**, **Interrupts/Status**, and **SIMO**) and an additional tab for controlling EV kit hardware (**Load Control**). See [Figure 6](#) for a screenshot of the GUI upon first opening.

## Installation

Visit the product webpage at [www.maximintegrated.com/max77680evkit](http://www.maximintegrated.com/max77680evkit) and navigate to *Design Resources* to download the latest version of the EV kit software. Save the EV kit software to a temporary folder and decompress the ZIP file.

## Windows Drivers

Upon connection of a micro-USB cable between your PC and the EV kit for the first time, wait a few minutes for Windows to automatically install the necessary drivers.

## Graphical User Interface (GUI) Details

The GUI drives I<sup>2</sup>C-communication with the EV kit. Every control in the GUI (excluding the **Load Control**) corresponds directly to a register within the MAX77680/MAX77681. Refer to the [AN6473: MAX77680/MAX77681 I<sup>2</sup>C-Compatible Serial Interface Implementation Guide](#) for a complete description of the registers. The **Load Control** and tabs provide additional functionality with the EV kit.

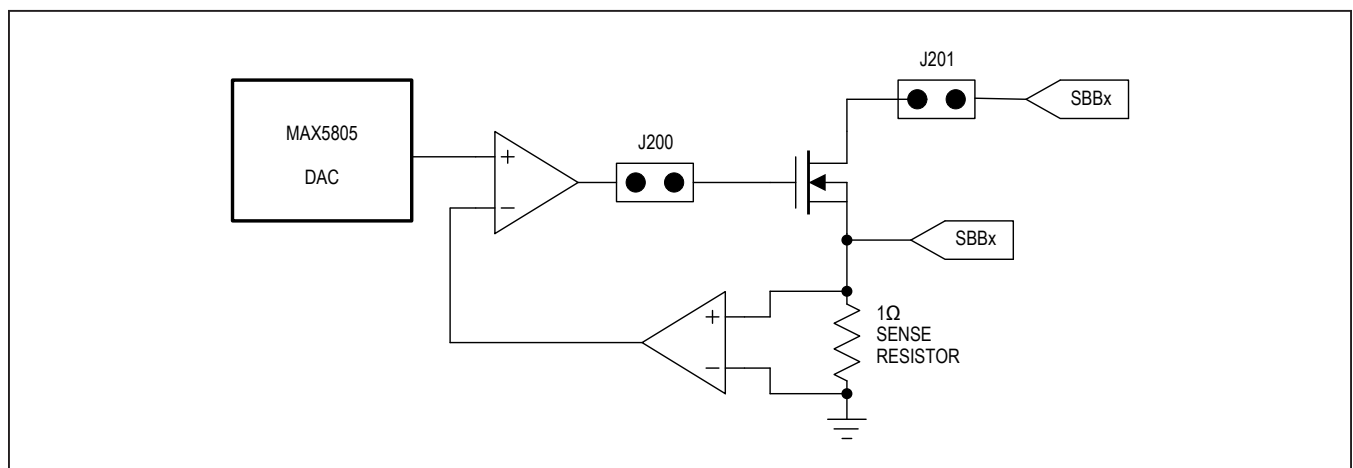

Figure 5. Electronic Load Circuit

**Load Control Tab**

The **Load Control** tab contains controls for setting load on the SIMO outputs. The GUI is capable of setting steady-state, transient, and random load currents. To set

a load current, use the slider-bar or text field to input a value (mA) and press the **Enable** button. Shuffle through the modes to exercise different load conditions. The offset and gain values are set by Maxim and do not need to be altered.

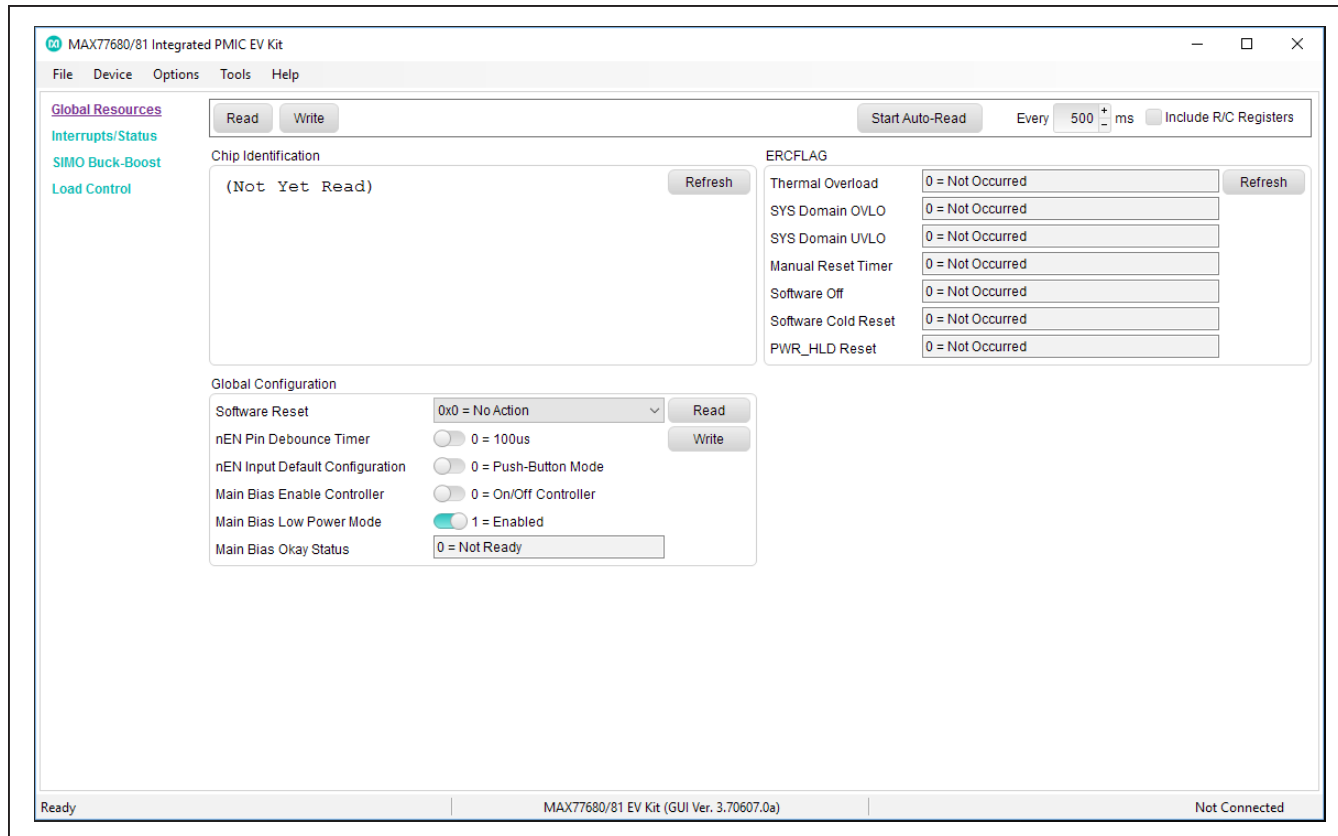

Figure 6. MAX77680/MAX77681 EV Kit GUI Top-Level Interface

**Ordering Information**

PART	TYPE
MAX77680EVKIT#	EV KIT
MAX77681EVKIT#	EV KIT

#Denotes a RoHS-compliant device that may include lead(Pb) that is exempt under the RoHS requirements.

MAX77680/MAX77681  
Evaluation Kit

Evaluates: MAX77680/MAX77681

MAX77680/MAX77681 EV Kit Bill of Materials

REF_DES	DNI/DNP	MAX77680 EVKIT QTY	MAX77681 EVKIT QTY	MFG PART #	MANUFACTURER	VALUE	DESCRIPTION
C1, C30	-	2	2	ANY	ANY	22UF	CAPACITOR; SMT (0603); CERAMIC CHIP; 22UF; 10V; TOL=20%; MODEL=CL SERIES; TG=-55 DEGC TO +85 DEGC; TC=X5R; FORMFACTOR
C2, C31, C32	-	3	3	ANY	ANY	0.01UF	CAPACITOR; SMT (0402); CERAMIC CHIP; 0.01UF; 10V; TOL=10%; MODEL=C0402C SERIES; TG=-55 DEGC TO +125 DEGC; TC=X7R
C4	-	1	1	GRM155R71H332KA01	MURATA	3300PF	CAPACITOR; SMT (0402); CERAMIC CHIP; 3300PF; 50V; TOL=10%; TG=-55 DEGC TO +125 DEGC; TC=X7R
C6, C8, C9, C20	-	4	4	ANY	ANY	10UF	CAPACITOR; SMT (0402); CERAMIC CHIP; 10UF; 6.3V; TOL=20%; MODEL=; TG=-55 DEGC TO +85 DEGC; TC=X5R; FORMFACTOR
C12, C110-C113, C115, C118, C120, C158, C239-C241	-	12	12	ANY	ANY	1UF	CAPACITOR; SMT (0402); CERAMIC CHIP; 1UF; 6.3V; TOL=20%; MODEL=C SERIES; TG=-55 DEGC TO +85 DEGC; TC=X5R; FORMFACTOR
C14, C108, C150, C151, C155-C157, C159, C202, C207, C212, C221-C223	-	14	14	ANY	ANY	0.1UF	CAPACITOR; SMT (0402); CERAMIC CHIP; 0.1UF; 25V; TOL=10%; MODEL=C SERIES; TG=-55 DEGC TO +125 DEGC; TC=X7R; FORMFACTOR
C27-C29	-	3	3	ANY	ANY	0.1UF	CAPACITOR; SMT; 0402; CERAMIC; 0.1UF; 10V; 10%; X5R; -55degC to + 125degC; 0 +/-30PPM/degC; FORMFACTOR ;
C114	-	1	1	ANY	ANY	0.47UF	CAPACITOR; SMT; 0603; CERAMIC; 0.47UF; 10V; 10%; X5R; -55degC to + 125degC. ; FORMFACTOR
C152, C153	-	2	2	GRM1555C1H150FA01	MURATA	15PF	CAPACITOR; SMT (0402); CERAMIC CHIP; 15PF; 50V; TOL=1%; TG=-55 DEGC TO +125 DEGC; TC=C0G
C154	-	1	1	ANY	ANY	4.7UF	CAPACITOR; SMT (0402); CERAMIC CHIP; 4.7UF; 10V; TOL=20%; MODEL=C SERIES; TG=-55 DEGC TO +85 DEGC; TC=X5R; FORMFACTOR
C200, C248, C250	-	3	3	C1005X5R1H472K050	TDK	4700PF	CAPACITOR; SMT (0402); CERAMIC CHIP; 4700PF; 50V; TOL=10%; TG=-55 DEGC TO +85 DEGC; TC=X5R
C201, C206, C211	-	3	3	ANY	ANY	1000PF	CAPACITOR; SMT (0402); CERAMIC CHIP; 1000PF; 50V; TOL=10%; MODEL=C0G; TG=-55 DEGC TO +125 DEGC; TC=+; FORMFACTOR
C203, C204, C208, C209, C213, C214	-	6	6	C0402C180J5GAC; GRM1555C1H180JA01J; C1005C0G1H180J050	KEMET/MURATA/TKD	18PF	CAPACITOR; SMT (0402); CERAMIC CHIP; 18PF; 50V; TOL=5%; TG=-55 DEGC TO +125 DEGC; TC=C0G
D100, D101	-	2	2	LTST-C190YKT	LITE-ON ELECTRONICS; INC.	LTST-C190YKT	DIODE; LED; STANDARD; YELLOW; SMT (0603); PIV=5.0V; IF=0.02A; -55 DEGC TO +85 DEGC
D102, D103	-	2	2	LTST-C190CKT	LITE-ON ELECTRONICS; INC.	LTST-C190CKT	DIODE; LED; STANDARD; RED; SMT (0603); PIV=5.0V; IF=0.04A; -55 DEGC TO +85 DEGC
SB80-SBB2, VSYS, EN_EXT	-	5	5	5010	KEYSTONE	N/A	TESTPOINT WITH 1.80MM HOLE DIA, RED, MULTIPURPOSE;
FB100	-	1	1	BLM18PG221SN1	MURATA	220	INDUCTOR; SMT (0603); FERRITE-BEAD; 220; TOL=+-25%; 1.4A; -55 DEGC TO +125 DEGC
GND1, GND5-GND7	-	4	4	5011	KEYSTONE	N/A	TEST POINT; PIN DIA=0.125IN; TOTAL LENGTH=0.445IN; BOARD HOLE=0.063IN; BLACK; PHOSPHOR BRONZE WIRE SILVER PLATE FINISH;
GND2-GND4, GND8	-	4	4	9020 BUSS	WEICO WIRE	MAXIMPAD	EVK KIT PARTS: MAXIM PAD; WIRE; NATURAL; SOLID; WEICO WIRE; SOFT DRAWN BUS TYPE-S; 20AWG
J2	-	1	1	PBC10SAAN	SULLINS ELECTRONICS CORP.	PBC10SAAN	CONNECTOR; MALE; THROUGH HOLE; BREAKAWAY; STRAIGHT; 10PINS; -65 DEGC TO +125 DEGC
J4, J5, J101	-	3	3	TSW-103-07-T-S	SAMTEC	TSW-103-07-T-S	CONNECTOR; THROUGH HOLE; TSW SERIES; SINGLE ROW; STRAIGHT; 3PINS
J6	-	1	1	10103592-0001LF	FCI CONNECT	10103592-0001LF	CONNECTOR; FEMALE; SMT; MICRO USB B-TYPE REVERSE; RIGHT ANGLE; 5PINS
J8, J200-J205	-	7	7	TSW-102-07-T-S	SAMTEC	TSW-102-07-T-S	CONNECTOR; THROUGH HOLE; TSW SERIES; SINGLE ROW; STRAIGHT; 2PINS; -55 DEGC TO +105 DEGC
J100	-	1	1	PBC06SAAN	SULLINS ELECTRONICS CORP.	PBC06SAAN	CONNECTOR; MALE; THROUGH HOLE; BREAKAWAY; STRAIGHT; 6PINS; -65 DEGC TO +125 DEGC
L1	-	1	1	DFE201210U-1R5M-P2	TOKO	1.5UH	EVKIT PART-INDUCTOR; SMT (0805); METAL ALLOY CHIP; 1.5UH; TOL=+-20%; 1.9A; 2.00MMX1.20MMX1.00MM
L3	-	1	1	CIGT201208EH2R2M2N	SAMSUNG ELECTRONICS	2.2UH	EVKIT PART-INDUCTOR; SMT (0805); METAL COMPOSITE CORE; 2.2UH; TOL=+-20%; 1.8A; 2.00MMX1.25MMX0.80MM
L4	-	1	1	CIGT201610EH2R2M2N	SAMSUNG ELECTRONICS	2.2UH	EVKIT PART-INDUCTOR; SMT (0806); METAL COMPOSITE CORE; 2.2UH; TOL=+-20%; 2.7A; 2.00MMX1.60MMX1.00MM
L5	-	1	1	DFE252007F-2R2M-P2	MURATA	2.2UH	EVKIT PART-INDUCTOR; SMT (1008); METAL ALLOY CHIP; 2.2UH; TOL=+-20%; 1.7A; 2.50MMX2.00MMX0.70MM
NEN, SCL, SDA, NIRO, NRST, PWRHLD	-	6	6	5002	KEYSTONE	N/A	TEST POINT; PIN DIA=0.1IN; TOTAL LENGTH=0.3IN; BOARD HOLE=0.04IN; WHITE; PHOSPHOR BRONZE WIRE SILVER;
Q1	-	1	1	FDY300NZ	FAIRCHILD SEMICONDUCTOR	FDY300NZ	TRAN; SINGLE N-CHANNEL 2.5V SPECIFIED POWERTRENCH MOSFET; NCH; SC89; PD-(0.625W); I-(0.6A); V-(20V)
Q200-Q202	-	3	3	IRFHM8337TRPBF	INTERNATIONAL RECTIFIER	IRFHM8337TRPBF	TRAN; HEXFET POWER MOSFET; NCH; PQFN8; PD-(2.8W); I-(18A); V-(30V)
R1, R3, R14, R115, R157, R159, R214, R283	-	8	8	ANY	ANY	100K	RESISTOR; 0402; 100K; 1%; 100PPM; 0.0625W; THICK FILM; FORMFACTOR
R2, R10	-	2	2	CRCW040210K0FK; RC0402FR-0710K	VISHAY DALE; YAGEO PHICOMP	10K	RESISTOR; 0402; 10K; 1%; 100PPM; 0.0625W; THICK FILM
R16	-	1	1	CRCW0402150RFFK; RC04021A1500FL	VISHAY DALE	150	RESISTOR; 0402; 150 OHM; 1%; 100PPM; 0.0625W; THICK FILM



MAX77680/MAX77681  
Evaluation Kit

Evaluates: MAX77680/MAX77681

MAX77680/MAX77681 EV Kit Bill of Materials (continued)

REF_DES	DNI/DNP	MAX77680 EVKIT QTY	MAX77681 EVKIT QTY	MFG PART #	MANUFACTURER	VALUE	DESCRIPTION
R17, R135, R136, R143, R148, R152, R155, R162, R165, R204, R225, R238, R305, R306	-	16	16	ANY	ANY	0	RESISTOR; 0402; 0 OHM; 1%; 100PPM; 0.0625W; THICK FILM; FORMFACTOR
R100, R118	-	2	2	ANY	ANY	4.7K	RESISTOR; 0402; 4.7K OHM; 1%; 100PPM; 0.0625W; THICK FILM; FORMFACTOR
R103, R123, R150	-	3	3	ANY	ANY	22	RESISTOR; 0402; 22 OHM; 1%; 100PPM; 0.0625W; THICK FILM; FORMFACTOR
R107, R108	-	2	2	ANY	ANY	2.2K	RESISTOR; 0402; 2.2K OHM; 1%; 100PPM; 0.0625W; THICK FILM; FORMFACTOR
R110, R161	-	2	2	CRCW0402470RFK	VISHAY DALE	470	RESISTOR; 0402; 470 OHM; 1%; 100PPM; 0.0625W; THICK FILM
R122	-	1	1	ANY	ANY	1M	RESISTOR; 0603; 1M; 1%; 100PPM; 0.10W; THICK FILM; FORMFACTOR
R142	-	1	1	ANY	ANY	0	RESISTOR; 0603; 0 OHM; 0%; JUMPER; 0.10W; THICK FILM; FORMFACTOR
R156	-	1	1	CRCW0402105KFK	VISHAY DALE	105K	RESISTOR; 0402; 105K OHM; 1%; 100PPM; 0.063W; THICK FILM
R158	-	1	1	CRCW0402169KFK	VISHAY DALE	169K	RESISTOR; 0402; 169K OHM; 1%; 100PPM; 0.063W; THICK FILM
R160	-	1	1	CRCW04024752FK; 9C04021A4752FLHF3; CRCW040247K5FK	VISHAY DALE	47.5K	RESISTOR; 0402; 47.5K; 1%; 100PPM; 0.0625W; THICK FILM
R109, R111, R201, R222, R235	-	5	5	CRCW0402100RFK; 9C04021A1000FL; RC0402FR-07100RL	VISHAY DALE; PANASONIC; YAGEO PHYCOMP	100	RESISTOR; 0402; 100 OHM; 1%; 100PPM; 0.063W; THICK FILM
R202, R223, R236	-	3	3	CRCW0402680RFK; RC0402FR-07680RL	VISHAY DALE/YAGEO PHICOMP	680	RESISTOR; 0402; 680 OHM; 1%; 100PPM; 0.0625W; THICK FILM
R203, R224, R237	-	3	3	CRCW040220K0FK	VISHAY DALE	20K	RESISTOR; 0402; 20K OHM; 1%; 100PPM; 0.063W; THICK FILM
R205, R206, R226, R228, R239, R240	-	6	6	CRCW04024991FK	VISHAY DALE	4.99K	RESISTOR; 0402; 4.99K; 1%; 100PPM; 0.0625W; THICK FILM
R207, R208, R229, R230, R242, R243	-	6	6	ANY	ANY	1K	RESISTOR; 0402; 1K; 1%; 100PPM; 0.0625W; THICK FILM; FORMFACTOR
R210, R231, R244	-	3	3	CRCW04021M00FK	VISHAY DALE	1M	RESISTOR; 0402; 1M; 1%; 100PPM; 0.0625W; THICK FILM
R211, R233, R245	-	3	3	ERJ-3RCF1R0V	PANASONIC	1	RESISTOR; 0603; 1 OHM; 1%; 100PPM; 0.10W; THICK FILM
R293, R295, R297	-	3	3	ERJ-2RFK4703X	PANASONIC	470K	RESISTOR; 0402; 470K OHM; 1%; 100PPM; 0.0625W; THICK FILM
R294, R296, R298	-	3	3	CRCW0402649KFK	VISHAY DALE	649K	RESISTOR; 0402; 649K OHM; 1%; 100PPM; 0.063W; THICK FILM
SW1	-	1	1	EVQ-Q2K03W	PANASONIC	EVQ-Q2K03W	SWITCH; SPST; SMT; 15V; 0.02A; LIGHT TOUCH SWITCH; RCOIL= OHM; RINSULATION= OHM; PANASONIC
SW2	-	1	1	CL-SB-12B-11	NIDEC COPAL ELECTRONICS CORP	CL-SB-12B-11	SWITCH; SPDT; SMT; 12V; 0.02A; CL-SB SERIES; SLIDE SWITCH; RCOIL=0.05 OHM; RINSULATION=100M OHM; NIDEC COPAL ELECTRONICS CORP
U1(MAX77680)	-	1	0	MAX77680AEW+	MAXIM	MAX77680	EVKIT PART-IC; WLP30; PACKAGE CODE: W302H2+1; CL30_SIMO
U1(MAX77681)	-	0	1	MAX77681AEW+	MAXIM	MAX77681	EVKIT PART-IC; WLP30; PACKAGE CODE: W302H2+1; CL30_SIMO
U100	-	1	1	MAXQ2000-RBX+	MAXIM	MAXQ2000-RBX+	IC; CTRL; LOW-POWER LCD MICROCONTROLLER; TOFN56-EP 8x8
U101	-	1	1	FT232RQ	FUTURE TECHNOLOGY DEVICES INTL LTD.	FT232RQ	IC; INFC; UART INTERFACE IC USB TO SERIAL; QFN32-EP 5X5
U102-U104	-	3	3	MAX8512EXK	MAXIM	MAX8512EXK	IC, VREG, Ultra-Low-Noise, High PSRR, Adjustable Vout, SC70-5
U107	-	1	1	MAX3395EETC	MAXIM	MAX3395EETC	IC; TRANS; 15KV ESD-PROTECTED HIGH-DRIVE CURRENT QUAD-LEVEL TRANSLATOR WITH SPEED-UP CIRCUITRY; TOFN12 4X4
U108	-	1	1	24AA02T-I/OT	MICROCHIP	24AA02T-I/OT	IC; EPROM; 2K I2C SERIAL EEPROM; SOT23-5
U200-U202	-	3	3	MAX44251AUA+	MAXIM	MAX44251AUA+	IC; OPAMP; ULTRA-PRECISION; LOW-NOISE OP AMP; UMAX8
U205	-	1	1	MAX5815AAUD+	MAXIM	MAX5815AAUD+	IC; DAC; ULTRA-SMALL; QUAD-CHANNEL; 12-BIT BUFFERED OUTPUT DAC WITH INTERNAL REFERENCE AND I2C INTERFACE; TSSOP14
VIL_SBB0-VIL_SBB2	-	3	3	5000	KEYSTONE	N/A	TEST POINT; PIN DIA=0.1IN; TOTAL LENGTH=0.3IN; BOARD HOLE=0.04IN; RED; PHOSPHOR BRONZE WIRE SILVER PLATE FINISH;
Y101	-	1	1	CX3225SB16000D0FLJZZ	KYOCERA-KINSEKI	16MHZ	CRYSTAL; SMT (3225) 3.2X2.5; 8PF; 16MHZ; +/-10PPM
PCB	-	1	1	MAX77680	MAXIM	PCB	PCB:MAX77680
L2	DNP	0	0	MLP1608VR47D	TDK	0.47UH	INDUCTOR; SMT (0603); SHIELDED; 0.47UH; TOL=+/-0.3nH; 0.5A
C19, C21, C22, C24, C26	DNP	0	0	N/A	N/A	OPEN	CAPACITOR; SMT (0402); OPEN; FORMFACTOR

NOTE: DNI--> DO NOT INSTALL (PACKOUT); DNP--> DO NOT PROCURE

**MAX77680/MAX77681 EV Kit Schematics**

Part Number	Configuration	7-bit	8-bit Write	8-bit Read
MAX77680 (PMIC)	ADDR OTP bit set for 0	0x40 0b100 0000	0x80 0b1000 0000	0x81 0b1000 0001
MAX77680 (PMIC)	ADDR OTP bit set for 1	0x48 0b100 1000	0x90 0b1001 0000	0x91 0b1001 0001
MAX77680 (PMIC)	Maxim internal test mode	0x49 0b100 1001	0x92 0b1001 0010	0x93 0b1001 0011
MAX5815 (DAC)	ADDR1=ADDR0=GND	0x1F 0b001 1111	0x3E 0b0011 1110 0x10* 0b0001 0000	0x3F 0b0011 1111
24AA02 (EEPROM)	N/A	0x50 to 0x57 0b1010xxx	0b1010xxx0	0b1010xxx1

\*MAX5815 ALSO RESPONDS TO AN I2C BROADCAST ADDRESS 0b0001 0000

MAX77680/MAX77681 EV Kit Schematics (continued)

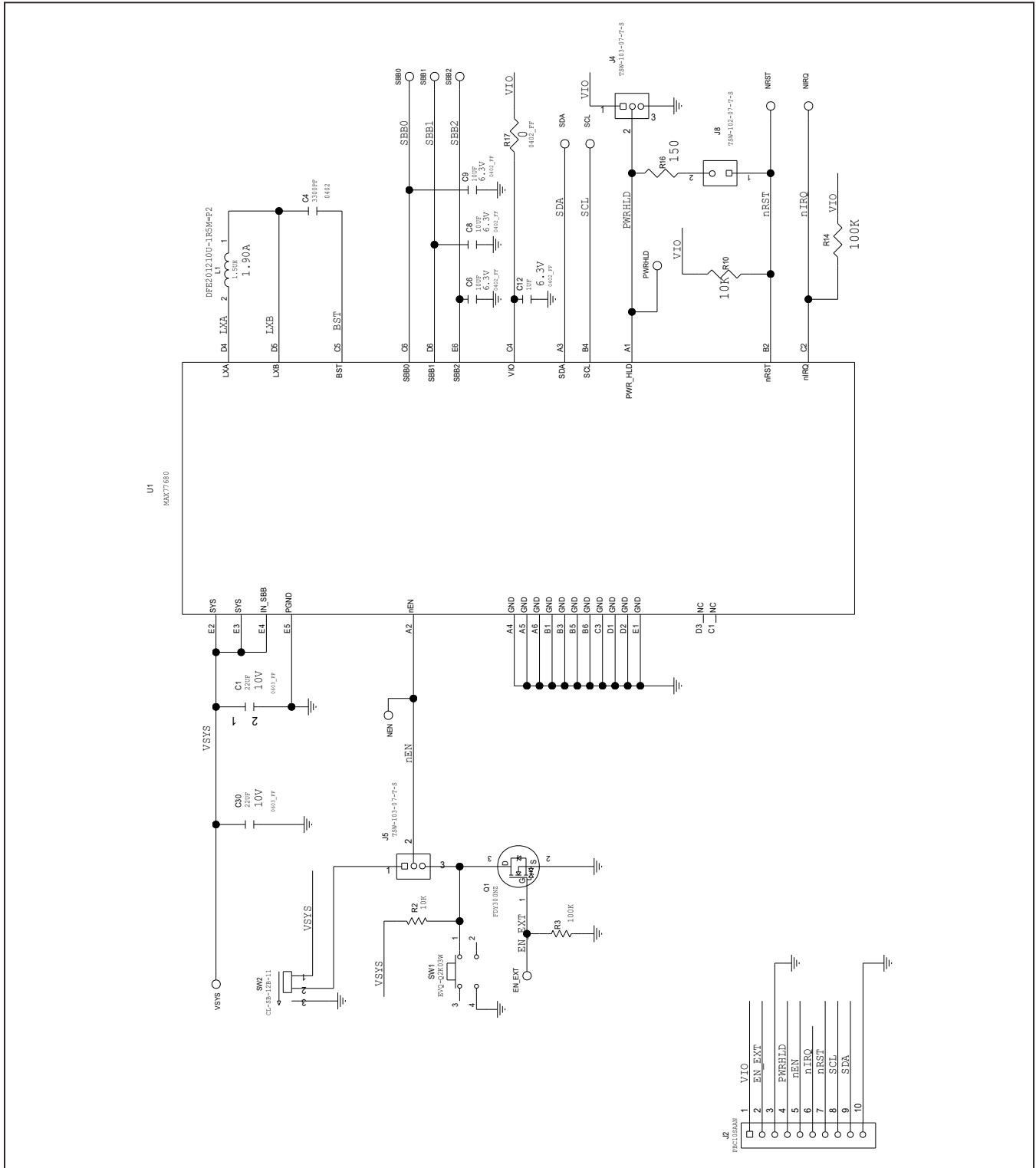

MAX77680/MAX77681 EV Kit Schematics (continued)

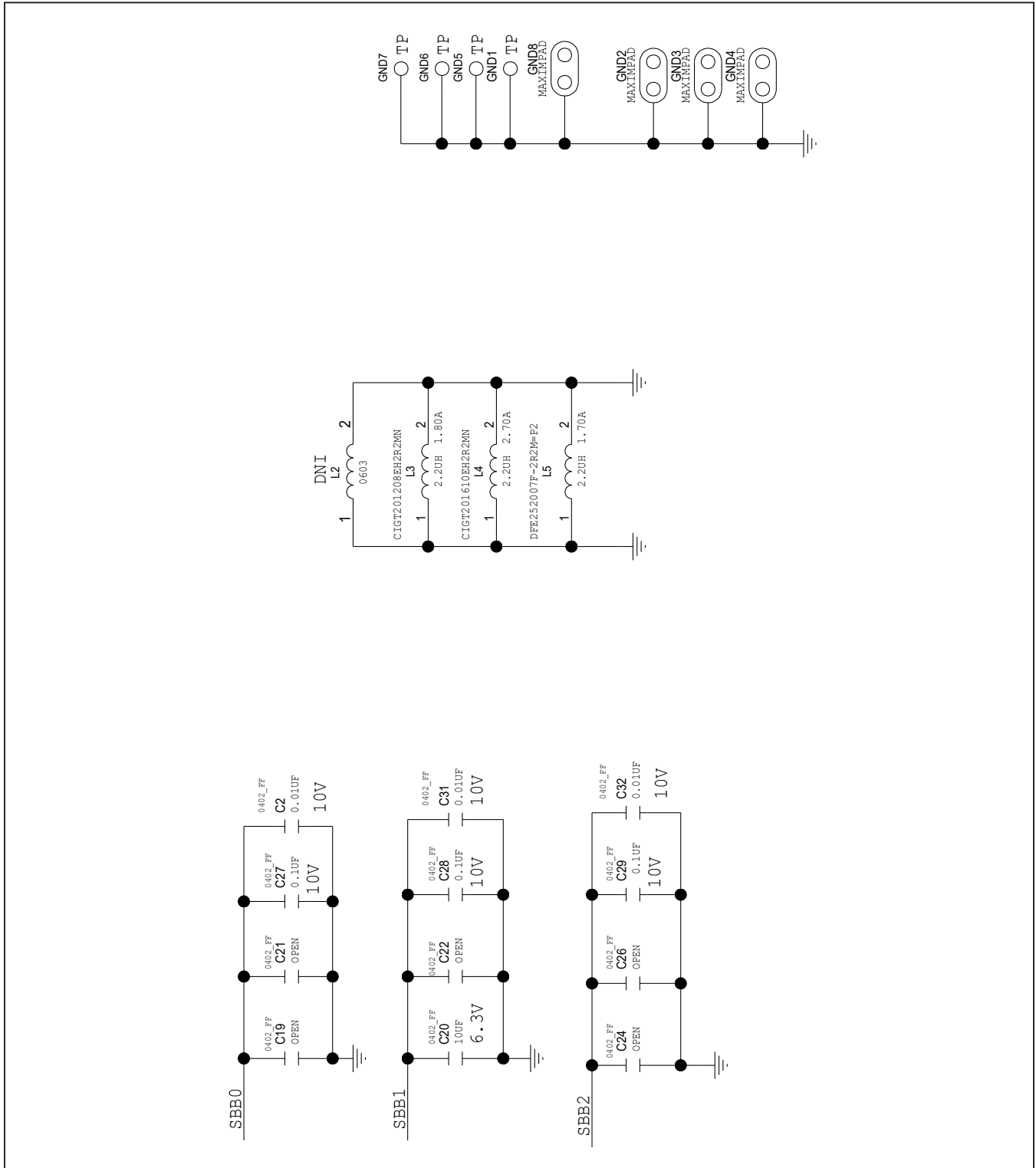

MAX77680/MAX77681 EV Kit Schematics (continued)

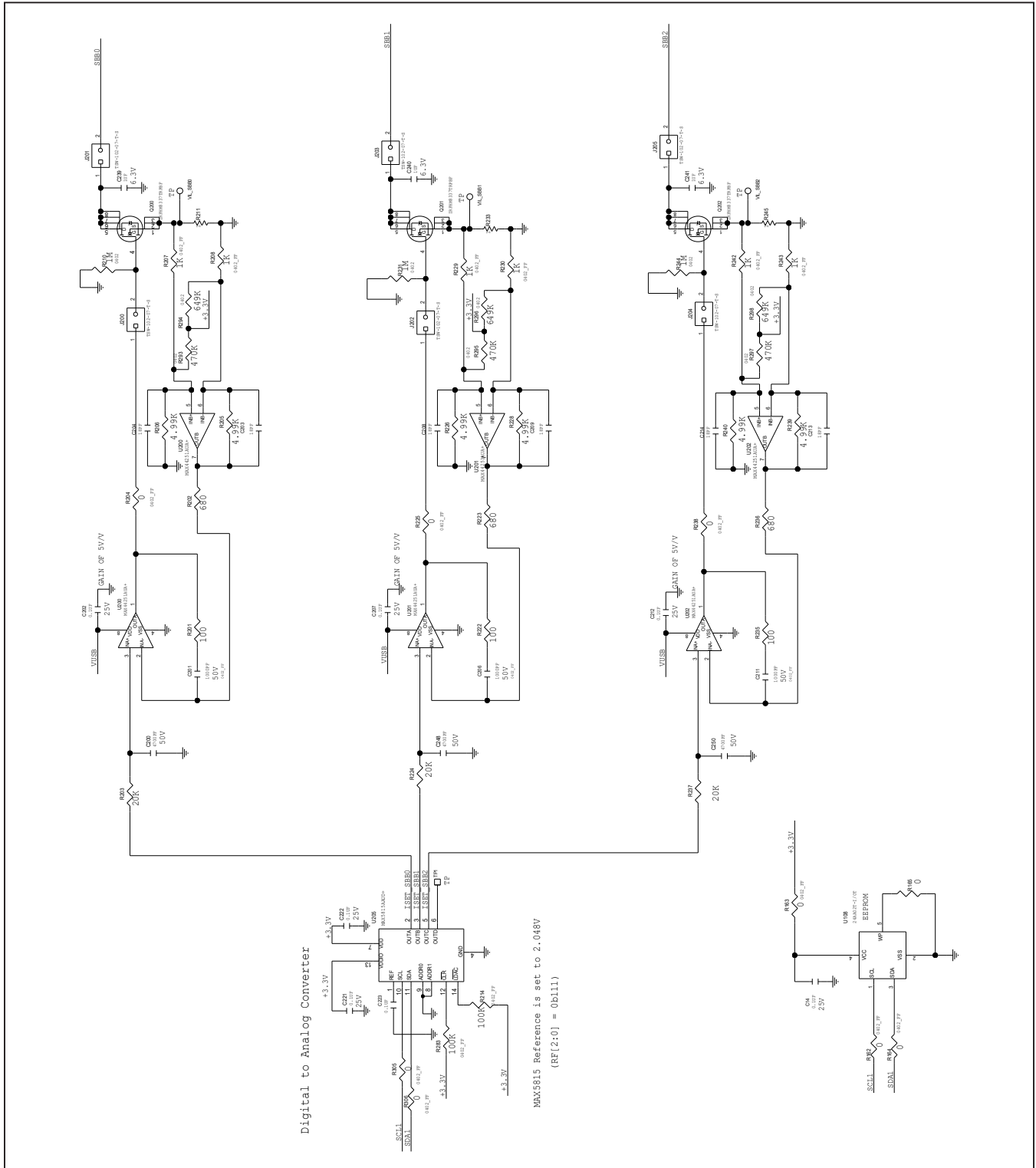

MAX77680/MAX77681 EV Kit Schematics (continued)

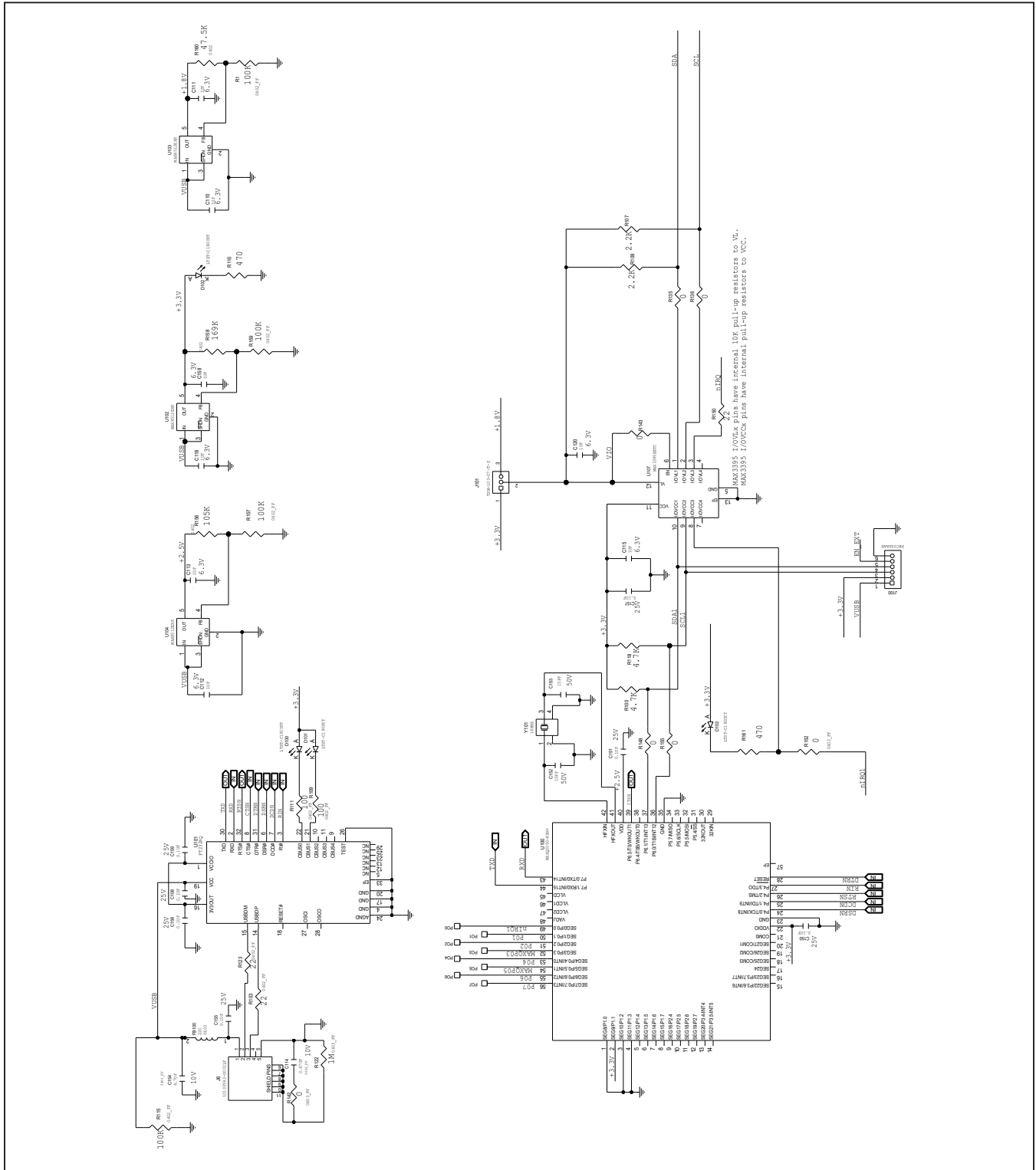

MAX77680/MAX77681 EV Kit Schematics (continued)

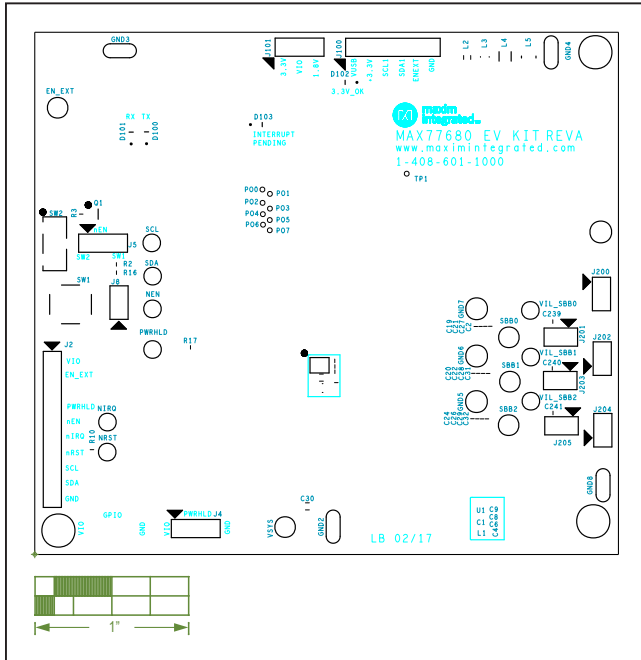

MAX77680/MAX77681 EV Kit Component Placement Guide—  
Top Silkscreen

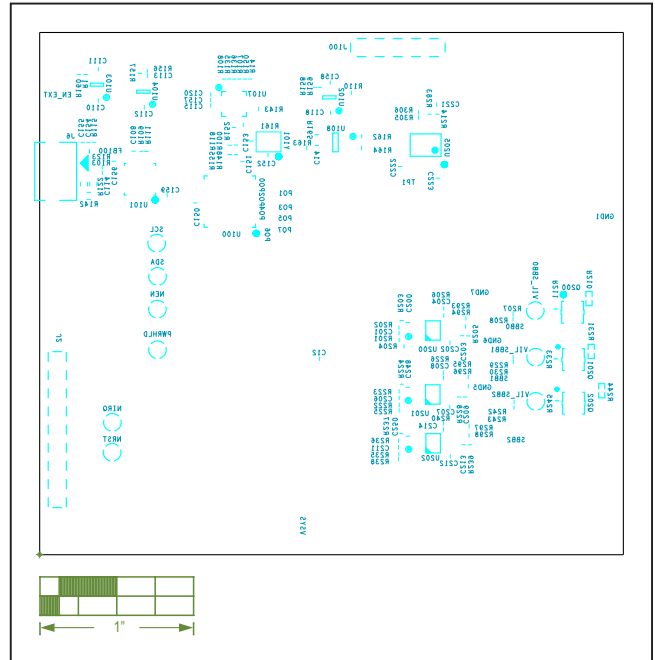

MAX77680/MAX77681 EV Kit Component Placement Guide—  
Bottom Silkscreen

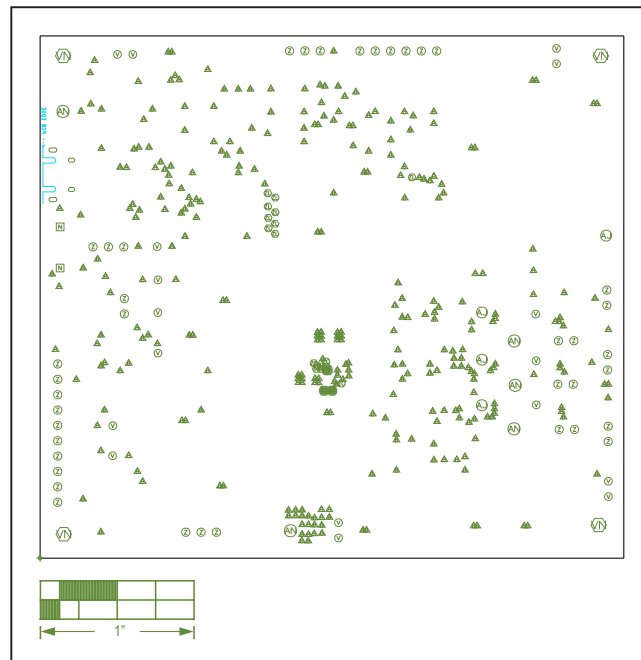

MAX77680/MAX77681 EV Kit PCB Layout—Fab Notes

MAX77680/MAX77681 EV Kit PCB Layouts (continued)

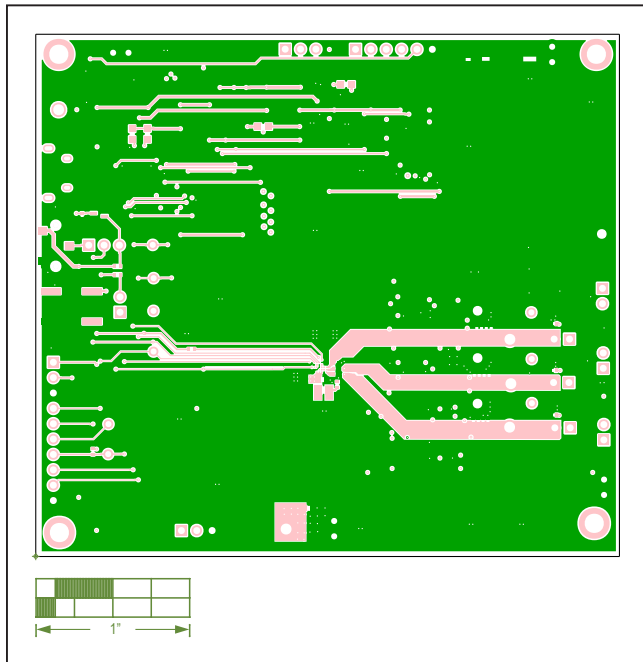

MAX77680/MAX77681 EV Kit PCB Layout—Top Layer

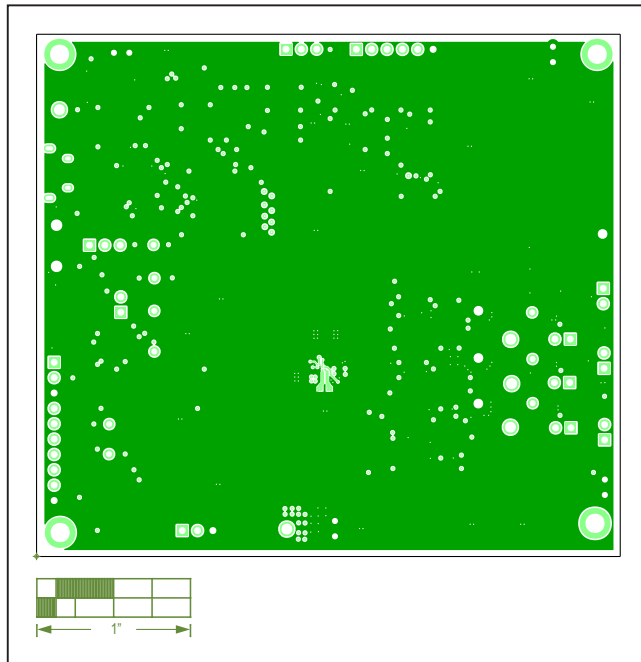

MAX77680/MAX77681 EV Kit PCB Layout—Internal Layer 2

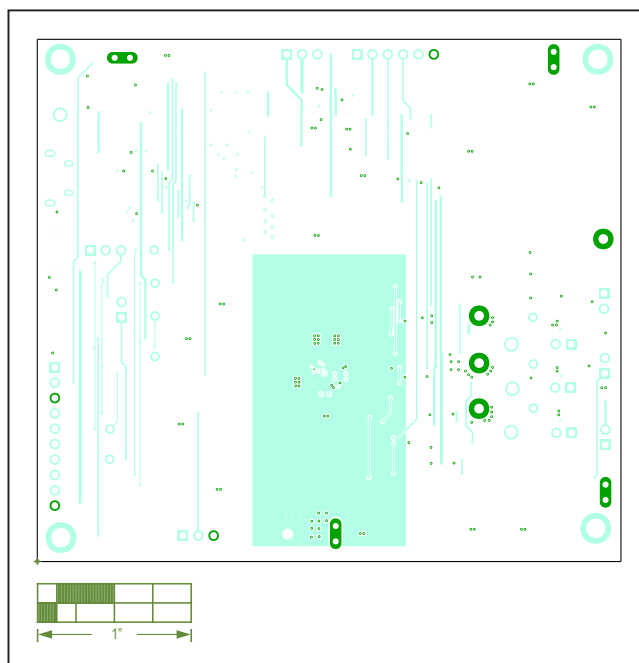

MAX77680/MAX77681 EV Kit PCB Layout—Internal Layer 3



MAX77680/MAX77681 EV Kit PCB Layouts (continued)

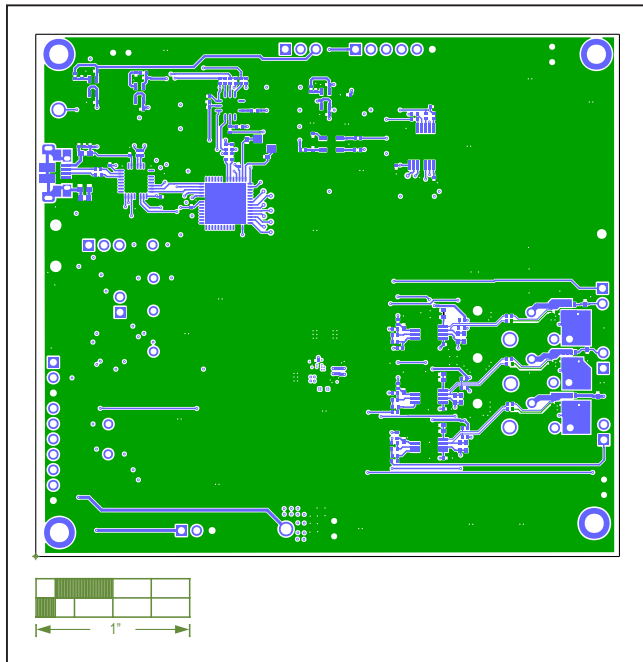

MAX77680/MAX77681 EV Kit PCB Layout—Bottom Layer

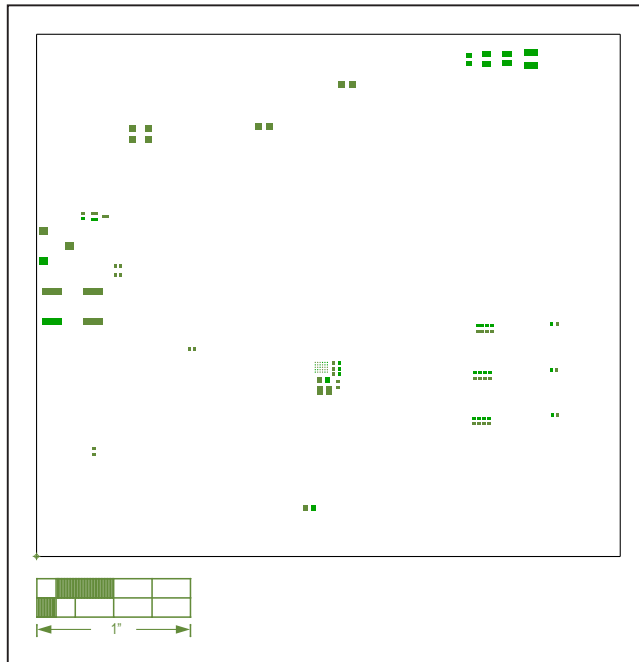

MAX77680/MAX77681 EV Kit PCB Layout—Paste Top

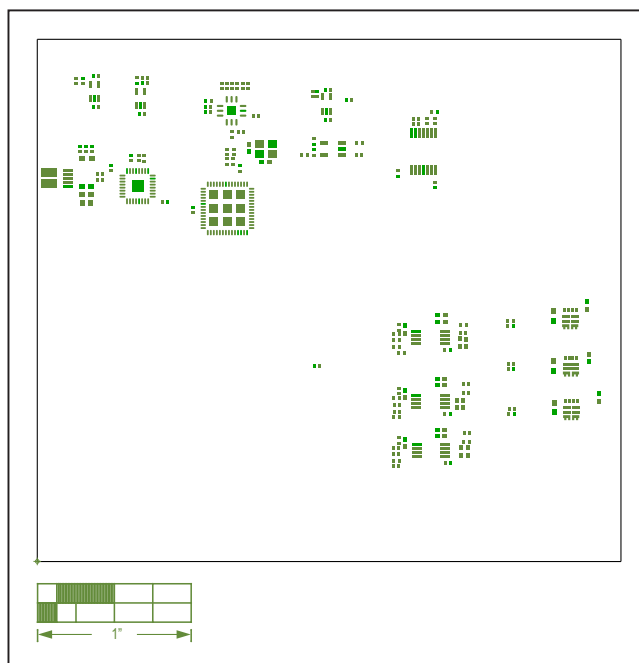

MAX77680/MAX77681 EV Kit PCB Layout—Paste Bottom

## Revision History

REVISION NUMBER	REVISION DATE	DESCRIPTION	PAGES CHANGED
0	6/18	Initial release	—
1	8/18	Updated <i>Ordering Information</i> table	7

For pricing, delivery, and ordering information, please contact Maxim Direct at 1-888-629-4642, or visit Maxim Integrated's website at [www.maximintegrated.com](http://www.maximintegrated.com).

*Maxim Integrated cannot assume responsibility for use of any circuitry other than circuitry entirely embodied in a Maxim Integrated product. No circuit patent licenses are implied. Maxim Integrated reserves the right to change the circuitry and specifications without notice at any time.*

Компания «Океан Электроники» предлагает заключение долгосрочных отношений при поставках импортных электронных компонентов на взаимовыгодных условиях!

Наши преимущества:

- Поставка оригинальных импортных электронных компонентов напрямую с производств Америки, Европы и Азии, а так же с крупнейших складов мира;
- Широкая линейка поставок активных и пассивных импортных электронных компонентов (более 30 млн. наименований);
- Поставка сложных, дефицитных, либо снятых с производства позиций;
- Оперативные сроки поставки под заказ (от 5 рабочих дней);
- Экспресс доставка в любую точку России;
- Помощь Конструкторского Отдела и консультации квалифицированных инженеров;
- Техническая поддержка проекта, помощь в подборе аналогов, поставка прототипов;
- Поставка электронных компонентов под контролем ВП;
- Система менеджмента качества сертифицирована по Международному стандарту ISO 9001;
- При необходимости вся продукция военного и аэрокосмического назначения проходит испытания и сертификацию в лаборатории (по согласованию с заказчиком);
- Поставка специализированных компонентов военного и аэрокосмического уровня качества (Xilinx, Altera, Analog Devices, Intersil, Interpoint, Microsemi, Actel, Aeroflex, Peregrine, VPT, Syfer, Eurofarad, Texas Instruments, MS Kennedy, Miteq, Cobham, E2V, MA-COM, Hittite, Mini-Circuits, General Dynamics и др.);

Компания «Океан Электроники» является официальным дистрибьютором и эксклюзивным представителем в России одного из крупнейших производителей разъемов военного и аэрокосмического назначения «JONHON», а так же официальным дистрибьютором и эксклюзивным представителем в России производителя высокотехнологичных и надежных решений для передачи СВЧ сигналов «FORSTAR».



## JONHON

«JONHON» (основан в 1970 г.)

Разъемы специального, военного и аэрокосмического назначения:

(Применяются в военной, авиационной, аэрокосмической, морской, железнодорожной, горно- и нефтедобывающей отраслях промышленности)

«FORSTAR» (основан в 1998 г.)

ВЧ соединители, коаксиальные кабели,  
кабельные сборки и микроволновые компоненты:

(Применяются в телекоммуникациях гражданского и специального назначения, в средствах связи, РЛС, а так же военной, авиационной и аэрокосмической отраслях промышленности).



Телефон: 8 (812) 309-75-97 (многоканальный)

Факс: 8 (812) 320-03-32

Электронная почта: [ocean@oceanchips.ru](mailto:ocean@oceanchips.ru)

Web: <http://oceanchips.ru/>

Адрес: 198099, г. Санкт-Петербург, ул. Калинина, д. 2, корп. 4, лит. А