

## Low Power/Fast MODE alternative 200mA LDO REGULATOR

NO.EA-279-160324

### OUTLINE

The RP202x Series consist of CMOS-based voltage regulator ICs with high output voltage accuracy, low dropout voltage and low supply current. These ICs perform with the chip enable function and realize a standby mode with ultra low supply current. To prevent the destruction by over current, the current limit circuit is included. The RP202 Series have 3-mode. One is standby mode with CE pin. The other two are the fast response mode (Fast Mode) and the low power mode, and switch over automatically according to the load current of the LDO. Supply current of IC itself at light load is automatically reduced. The output voltage is maintained between Fast Mode and ECO Mode.

The RP202x consists of a voltage reference unit, an error amplifier, a resistor net for voltage setting, and a current limit circuit.

Since the packages for these ICs are SOT-23-5, SC-88A, and DFN(PLP)1010-4, high density mounting of the ICs on boards is possible.

### FEATURES

- Input Voltage Range ..... 1.4V to 5.25V
- Output Voltage Range ..... 0.8V to 4.0V (0.1V steps)  
(For other voltages, please refer to MARK INFORMATIONS.)
- Supply Current ( $I_{OUT}=0mA$ ) ..... Typ. 2.5 $\mu A$
- Supply Current ( $I_{OUT}=10mA$ ) ..... Typ. 50 $\mu A$
- Supply Current (Standby Mode) ..... Typ. 0.1 $\mu A$
- Dropout Voltage ..... Typ. 0.20V ( $I_{OUT}=200mA$ ,  $V_{OUT}=2.8V$ )
- Ripple Rejection..... Typ. 70dB ( $f=1kHz$ ,  $V_{OUT}=2.8V$ ,  $I_{OUT}=30mA$ )
- Line Regulation..... Typ. 0.02%/V ( $I_{OUT}=10mA$ )
- Packages ..... DFN(PLP)1010-4, SC-88A, SOT-23-5
- Built-in Foldback Protection Circuit..... Typ. 60mA (Current at short mode)
- Built-in Constant Slope Circuit (Soft-start Function)
- Ceramic capacitors are recommended to be used with this IC .....0.47 $\mu F$  or more

### APPLICATIONS

- Power source for portable communication equipment.
- Power source for electrical appliances such as cameras, VCRs and camcorders.
- Power source for battery-powered equipment.

**BLOCK DIAGRAMS**

**RP202xxxxB**

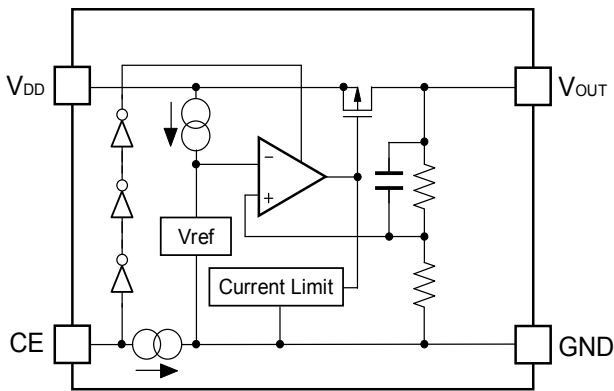

**RP202xxxxD**

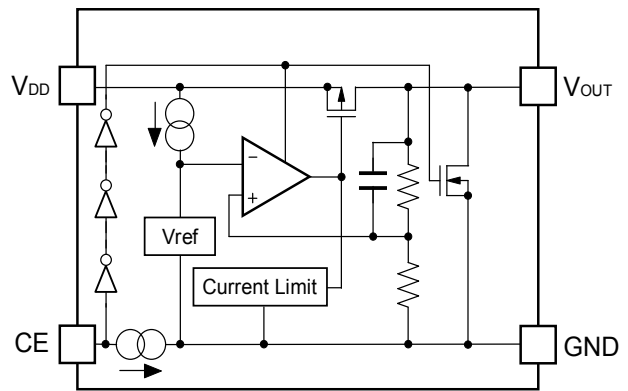

**SELECTION GUIDE**

The output voltage, auto discharge function, and package, for the ICs can be selected at the user's request.

Product Name	Package	Quantity per Reel	Pb Free	Halogen Free
RP202Kxx1*-TR	DFN(PLP)1010-4	10,000pcs	Yes	Yes
RP202Qxx2*-TR-FE	SC-88A	3,000pcs	Yes	Yes
RP202Nxx1*-TR-FE	SOT-23-5	3,000pcs	Yes	Yes

xx: The output voltage can be designated in the range from 0.8V(08) to 4.0V(40) in 0.1V steps.

\* : The auto discharge function at off state are options as follows.  
 (B) without auto discharge function at off state  
 (D) with auto discharge function at off state

Auto-discharge function quickly lowers the output voltage to 0V, when the chip enable signal is switched from the active mode to the standby mode, by releasing the electrical charge accumulated in the external capacitor.

## PIN CONFIGURATIONS

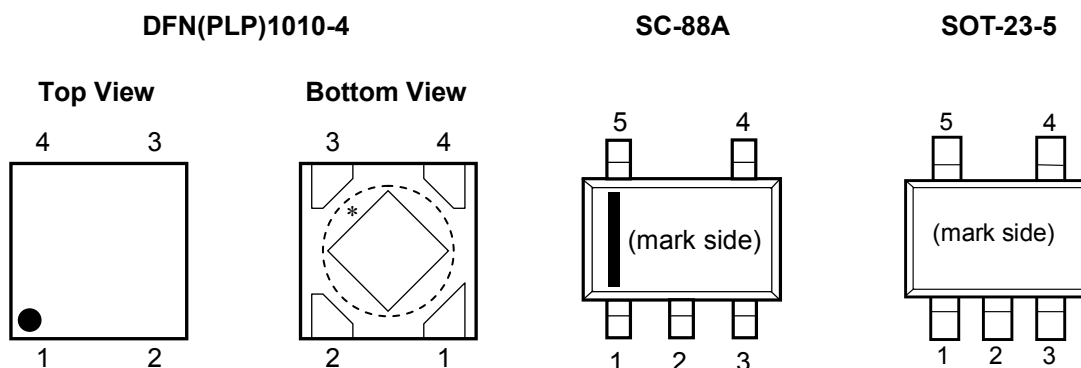

## PIN DESCRIPTIONS

### DFN(PLP)1010-4

Pin No	Symbol	Pin Description
1	$V_{OUT}$	Output Pin
2	GND	Ground Pin
3	CE	Chip Enable Pin ("H" Active)
4	$V_{DD}$	Input Pin

\* Tab is GND level. (They are connected to the reverse side of this IC.) The tab is better to be connected to the GND, but leaving it open is also acceptable.

### SC-88A

Pin No	Symbol	Pin Description
1	CE	Chip Enable Pin ("H" Active)
2	NC	No Connection
3	GND	Ground Pin
4	$V_{OUT}$	Output Pin
5	$V_{DD}$	Input Pin

### SOT-23-5

Pin No	Symbol	Pin Description
1	$V_{DD}$	Input Pin
2	GND	Ground Pin
3	CE	Chip Enable Pin ("H" Active)
4	NC	No Connection
5	$V_{OUT}$	Output Pin

**ABSOLUTE MAXIMUM RATINGS**

Symbol	Item	Rating	Unit
$V_{IN}$	Input Voltage	6.0	V
$V_{CE}$	Input Voltage (CE Pin)	-0.3 to 6.0	V
$V_{OUT}$	Output Voltage	-0.3 to $V_{IN} + 0.3$	V
$I_{OUT}$	Output Current	220	mA
$P_D$	Power Dissipation (DFN(PLP)1010-4) (Standard Test Land Pattern) *	400	mW
	Power Dissipation (SC-88A) (Standard Test Land Pattern) *	380	
	Power Dissipation (SOT-23-5) (Standard Test Land Pattern) *	420	
$T_a$	Operating Temperature Range	-40 to 85	°C
$T_{stg}$	Storage Temperature Range	-55 to 125	°C

\*) For Power Dissipation, please refer to PACKAGE INFORMATION.

**ABSOLUTE MAXIMUM RATINGS**

Electronic and mechanical stress momentarily exceeded absolute maximum ratings may cause the permanent damages and may degrade the life time and safety for both device and system using the device in the field. The functional operation at or over these absolute maximum ratings is not assured.

**RECOMMENDED OPERATING CONDITIONS (ELECTRICAL CHARACTERISTICS)**

All of electronic equipment should be designed that the mounted semiconductor devices operate within the recommended operating conditions. The semiconductor devices cannot operate normally over the recommended operating conditions, even if when they are used over such conditions by momentary electronic noise or surge. And the semiconductor devices may receive serious damage when they continue to operate over the recommended operating conditions.

## ELECTRICAL CHARACTERISTICS

$V_{IN}$ =Set  $V_{OUT}+1V$ ,  $I_{OUT}=1mA$ ,  $C_{IN}=C_{OUT}=0.47\mu F$ , unless otherwise noted.

The specification in   is checked and guaranteed by design engineering at  $-40^{\circ}C \leq T_a \leq 85^{\circ}C$ . (Ta=25°C)

Symbol	Item	Conditions	Min.	Typ.	Max.	Unit	
$V_{OUT}$	Output Voltage	$I_{OUT}=5mA$ (Fast Mode) $T_a=25^{\circ}C$	$V_{OUT} > 2.0V$	$\times 0.99$		$\times 1.01$	V
			$V_{OUT} \leq 2.0V$	-20mV		20mV	
		$I_{OUT}=5mA$ (Fast Mode) $-40^{\circ}C \leq T_a \leq 85^{\circ}C$	$V_{OUT} > 2.0V$	<span style="border: 1px solid black; padding: 0 2px;">×0.965</span>		<span style="border: 1px solid black; padding: 0 2px;">×1.025</span>	
			$V_{OUT} \leq 2.0V$	<span style="border: 1px solid black; padding: 0 2px;">-70mV</span>		<span style="border: 1px solid black; padding: 0 2px;">50mV</span>	
$I_{OUT}$	Output Current		<span style="border: 1px solid black; padding: 0 2px;">200</span>			mA	
$\frac{\Delta V_{OUT}}{\Delta I_{OUT}}$	Load Regulation	$1mA \leq I_{OUT} \leq 10mA$	$V_{OUT} > 2.0V$	-1.0		1.0	%
			$V_{OUT} \leq 2.0V$	-20		20	mV
		$10mA \leq I_{OUT} \leq 200mA$		<span style="border: 1px solid black; padding: 0 2px;">-20</span>	10	<span style="border: 1px solid black; padding: 0 2px;">30</span>	mV
$V_{DIF}$	Dropout Voltage	Refer to the "Dropout Voltage"					
$I_{SS1}$	Supply Current ( $I_{OUT}=0mA$ )*1	$I_{OUT}=0mA$		2.5	<span style="border: 1px solid black; padding: 0 2px;">5.0</span>	$\mu A$	
$I_{SS2}$	Supply Current ( $I_{OUT}=10mA$ )	$I_{OUT}=10mA$		50		$\mu A$	
Istandby	Standby Current	$V_{CE}=GND$		0.1	1.0	$\mu A$	
$I_{OUTH}$	Fast Mode switch-over current	$I_{OUT}$ = Light load to Heavy load			<span style="border: 1px solid black; padding: 0 2px;">8.0</span>	mA	
$I_{OUTL}$	Low Power Mode switch-over current	$I_{OUT}$ = Heavy load to Light load	<span style="border: 1px solid black; padding: 0 2px;">1.0</span>	2.0		mA	
$\frac{\Delta V_{OUT}}{\Delta V_{IN}}$	Line Regulation	$V_{OUT}+0.5V \leq V_{IN} \leq 5V$ $1.4V \leq V_{IN}$	$I_{OUT}=1mA$ (Low Power Mode)			<span style="border: 1px solid black; padding: 0 2px;">±0.50</span>	%V
			$I_{OUT}=10mA$ (Fast Mode)		$\pm 0.02$	<span style="border: 1px solid black; padding: 0 2px;">±0.10</span>	
RR	Ripple Rejection	$f=1kHz$ Ripple 0.2Vp-p $V_{IN}=V_{OUT}+1.0V$ , $I_{OUT}=30mA$	$V_{OUT} \leq 1.8V$		75		dB
			$1.8 < V_{OUT} \leq 2.8V$		70		
			$2.8 < V_{OUT} \leq 3.3V$		65		
			$3.3 < V_{OUT}$		60		
$V_{IN}$	Input Voltage		<span style="border: 1px solid black; padding: 0 2px;">1.4</span>		<span style="border: 1px solid black; padding: 0 2px;">5.25</span>	V	
$\frac{\Delta V_{OUT}}{\Delta T_a}$	Output Voltage Temperature Coefficient	$-40^{\circ}C \leq T_a \leq 85^{\circ}C$		$\pm 100$		ppm/ $^{\circ}C$	
$I_{SC}$	Short Current Limit	$V_{OUT}=0V$		60		mA	
$I_{CEPD}$	CE Pull-down Constant Current			0.3	<span style="border: 1px solid black; padding: 0 2px;">0.6</span>	$\mu A$	
$V_{CEH}$	CE Input Voltage "H"		<span style="border: 1px solid black; padding: 0 2px;">1.0</span>			V	
$V_{CEL}$	CE Input Voltage "L"				<span style="border: 1px solid black; padding: 0 2px;">0.4</span>	V	
$R_{LOW}$	Low Output Nch Tr. ON Resistance (of D version)	$V_{IN} = 4.0V$ $V_{CE} = 0V$		60		$\Omega$	

All of units are tested and specified under load conditions such that  $T_j \approx T_a = 25^{\circ}C$  except for Ripple Rejection, Output Voltage Temperature Coefficient.

\*1) The value of supply current is excluding the Pull-down constant current of CE Pin.

**RP202**

NO.EA-279-160324

**Dropout Voltage**

Ta=25°C

Output Voltage V <sub>OUT</sub> (V)	Dropout Voltage V <sub>DIF</sub> (V)		
	Condition	Typ.	Max.
0.8 ≤ V <sub>OUT</sub> < 0.9	I <sub>OUT</sub> =200mA	0.60	0.79
0.9 ≤ V <sub>OUT</sub> < 1.0		0.55	0.73
1.0 ≤ V <sub>OUT</sub> < 1.1		0.50	0.64
1.1 ≤ V <sub>OUT</sub> < 1.2		0.45	0.61
1.2 ≤ V <sub>OUT</sub> < 1.3		0.40	0.56
1.3 ≤ V <sub>OUT</sub> < 1.4		0.37	0.53
1.4 ≤ V <sub>OUT</sub> < 1.5		0.34	0.48
1.5 ≤ V <sub>OUT</sub> < 1.8		0.31	0.43
1.8 ≤ V <sub>OUT</sub> < 2.1		0.27	0.39
2.1 ≤ V <sub>OUT</sub> < 2.5		0.245	0.36
2.5 ≤ V <sub>OUT</sub> < 2.8		0.215	0.31
2.8 ≤ V <sub>OUT</sub> < 3.0		0.20	0.29
3.0 ≤ V <sub>OUT</sub> < 3.3		0.19	0.28
3.3 ≤ V <sub>OUT</sub> < 3.6		0.18	0.27
3.6 ≤ V <sub>OUT</sub>		0.175	0.27

## TYPICAL APPLICATION

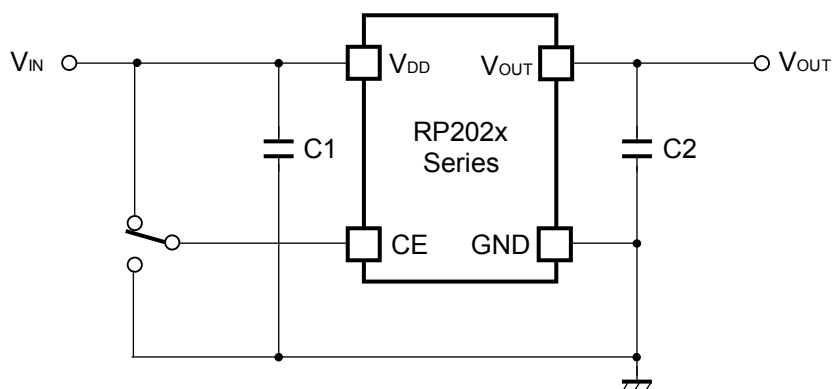

(External Components)

C1, C2 : Ceramic Capacitor 0.47 $\mu$ F MURATA: GRM155B31A474KE14

## TECHNICAL NOTES

When using these ICs, consider the following points:

### Phase Compensation

In these ICs, phase compensation is made for securing stable operation even if the load current is varied. For this purpose, use a capacitor C2 with 0.47 $\mu$ F or more and good ESR (Equivalent Series Resistance).

(Note: If additional ceramic capacitors are connected with parallel to the output pin with an output capacitor for phase compensation, the operation might be unstable. Because of this, test these ICs with as same external components as ones to be used on the PCB.)

### PCB Layout

The impedances of V<sub>DD</sub> line and GND line has to be low as possible. The high impedances may result in the unstable operation or a noise pickup. The output capacitor with 0.47 $\mu$ F or more should be placed between V<sub>DD</sub> and GND. The line from V<sub>DD</sub> to the output capacitor, and the line from the output capacitor to GND must be wired as short as possible.

The output capacitor is placed between V<sub>OUT</sub> and GND as phase compensation. The line from V<sub>OUT</sub> to the output capacitor, and the line from the capacitor to GND must be wired as short as possible. Please refer to the "Basic Test Circuit" below.

# TEST CIRCUITS

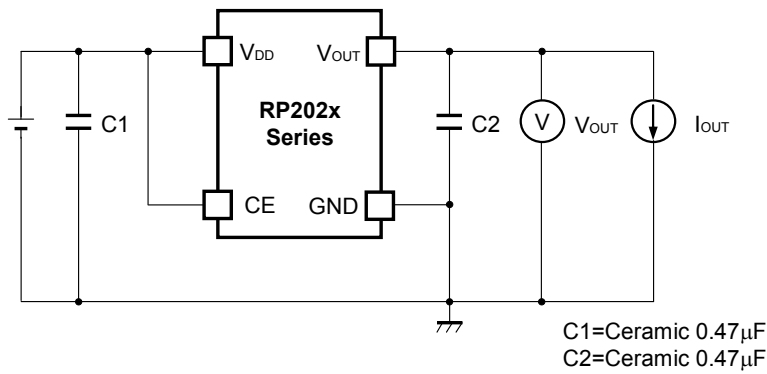

Basic Test Circuit

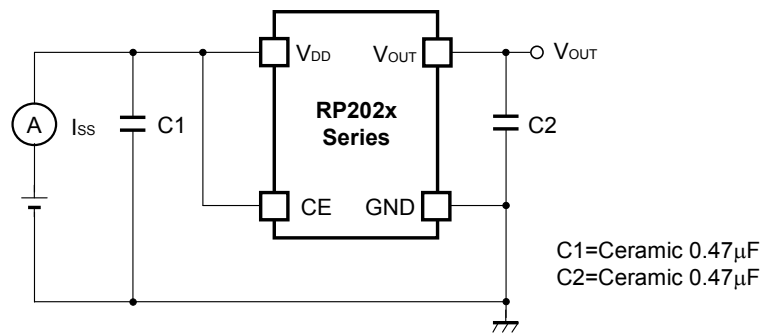

Test Circuit for Supply Current

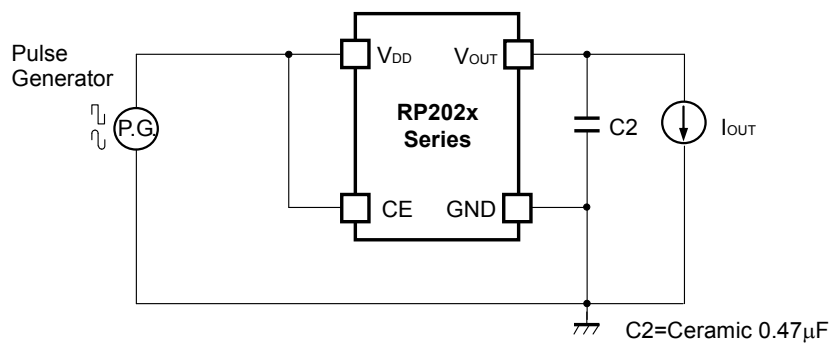

Test Circuit for Ripple Rejection

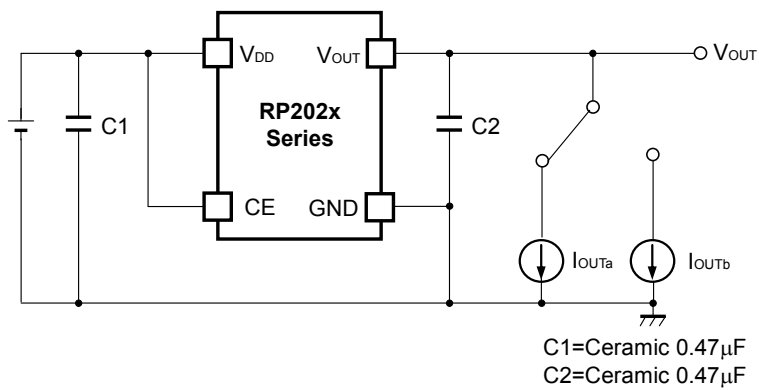

Test Circuit for Load Transient Response



## TYPICAL CHARACTERISTICS

### 1) Output Voltage vs. Output Current (C1=0.47μF, C2=0.47μF, Ta=25°C)

RP202x08xx

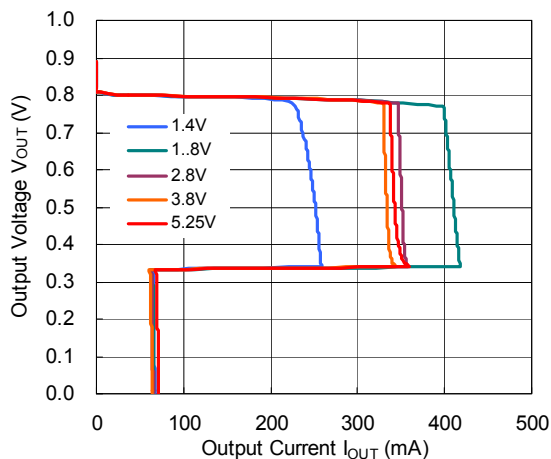

RP202x18xx

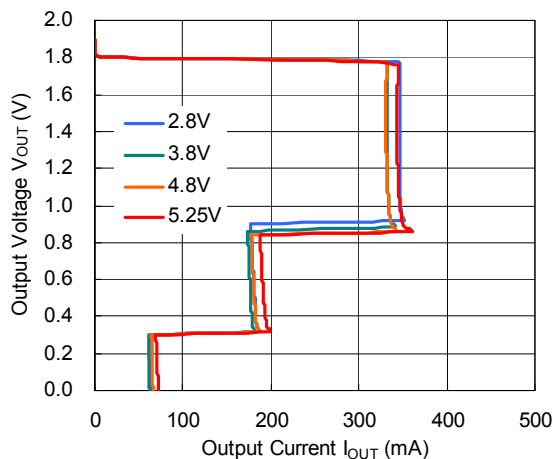

RP202x28xx

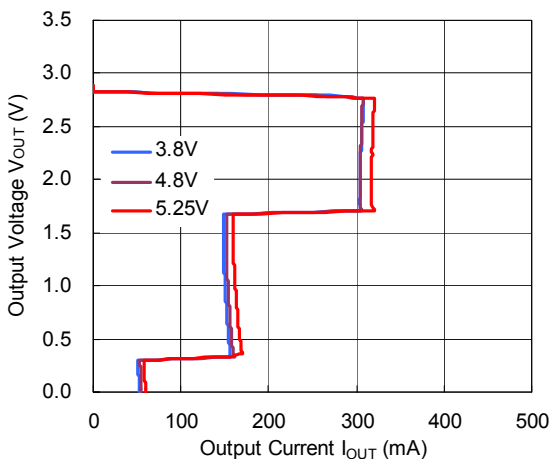

RP202x40xx

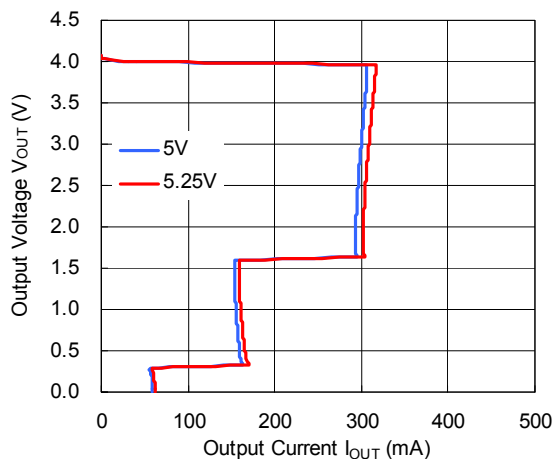

### 2) Output Voltage vs. Input Voltage (C1=0.47μF, C2=0.47μF, Ta=25°C)

RP202x08xx

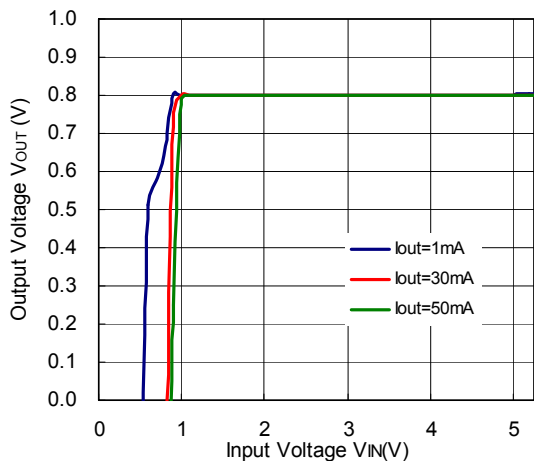

RP202x18xx

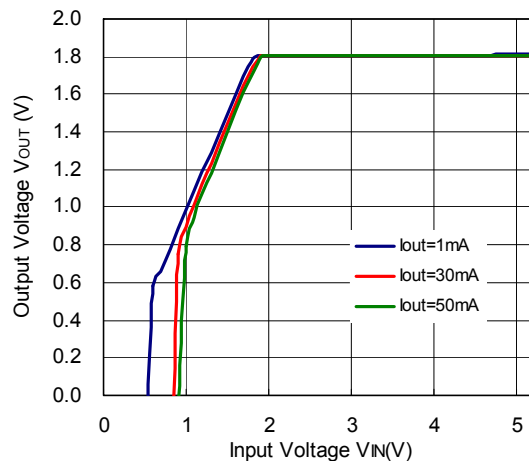

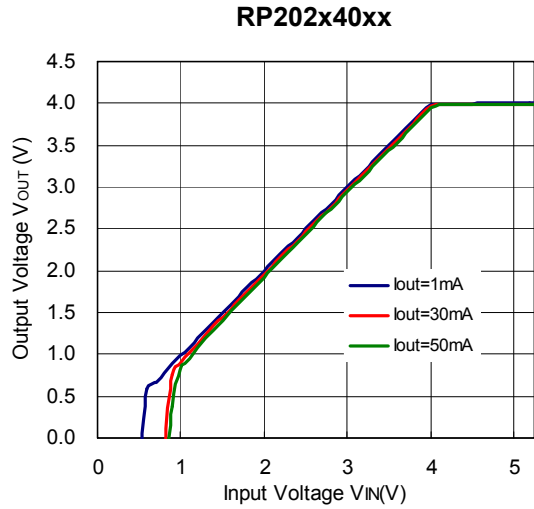
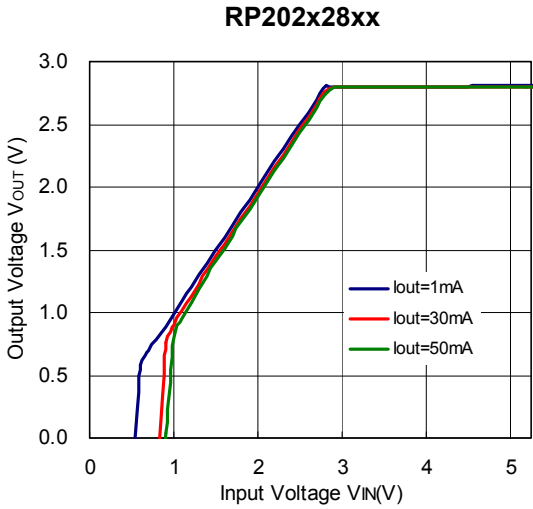

**3) Supply Current vs. Input Voltage ( $C1=0.47\mu F$ ,  $C2=0.47\mu F$ ,  $T_a=25^\circ C$ )**

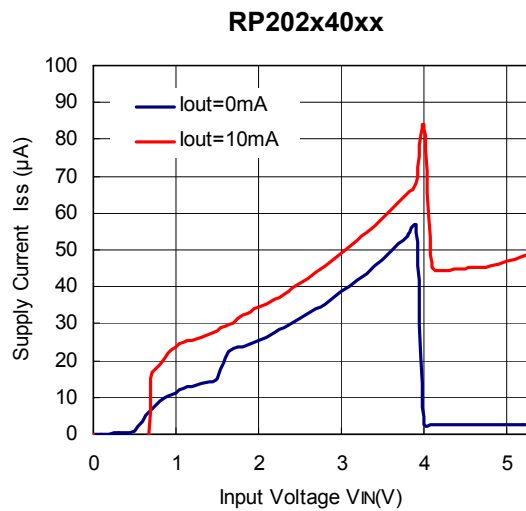
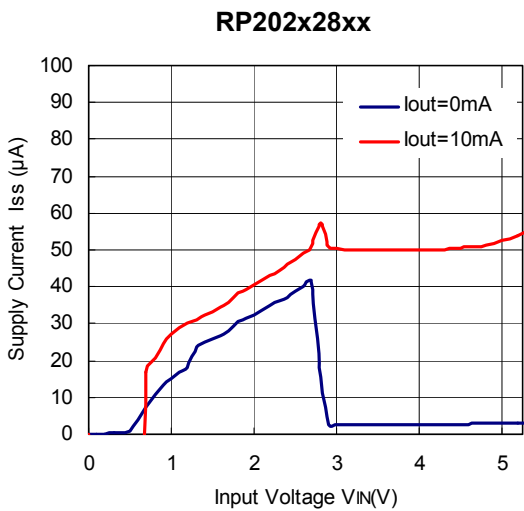
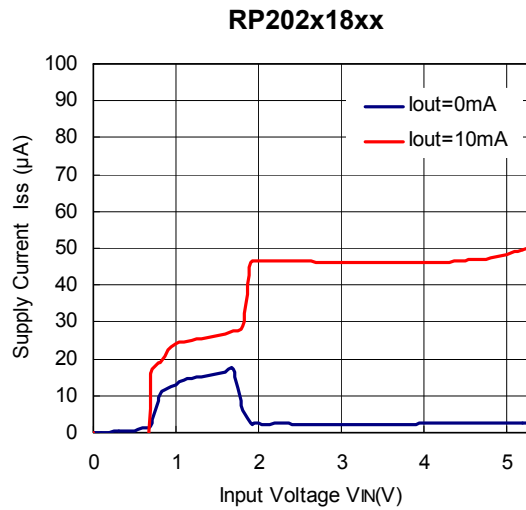
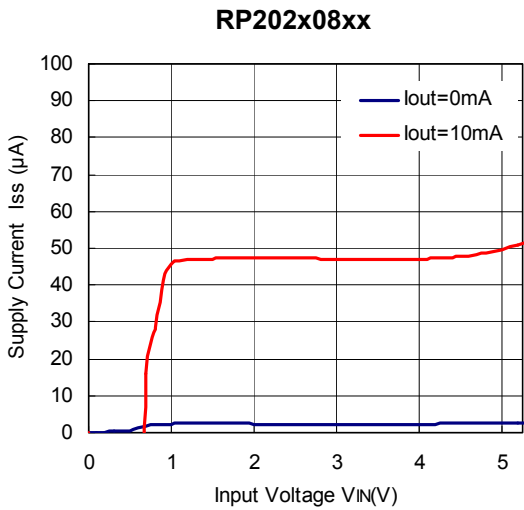

4) Supply Current vs. Output Current (C1=0.47μF, C2=0.47μF, Ta=25°C)

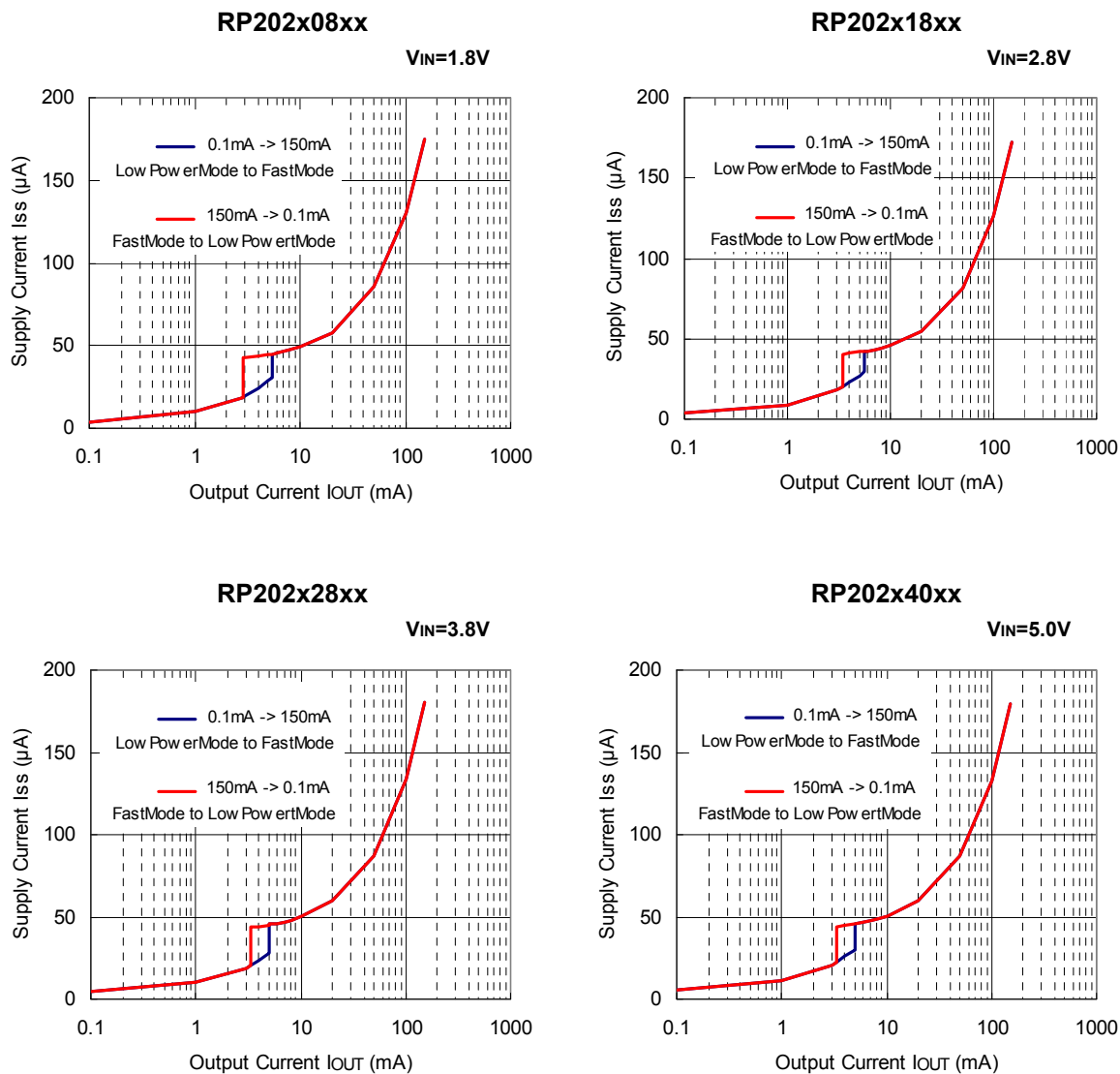

5) Output Voltage vs. Temperature (C1=0.47μF, C2=0.47μF, IOUT=1mA)

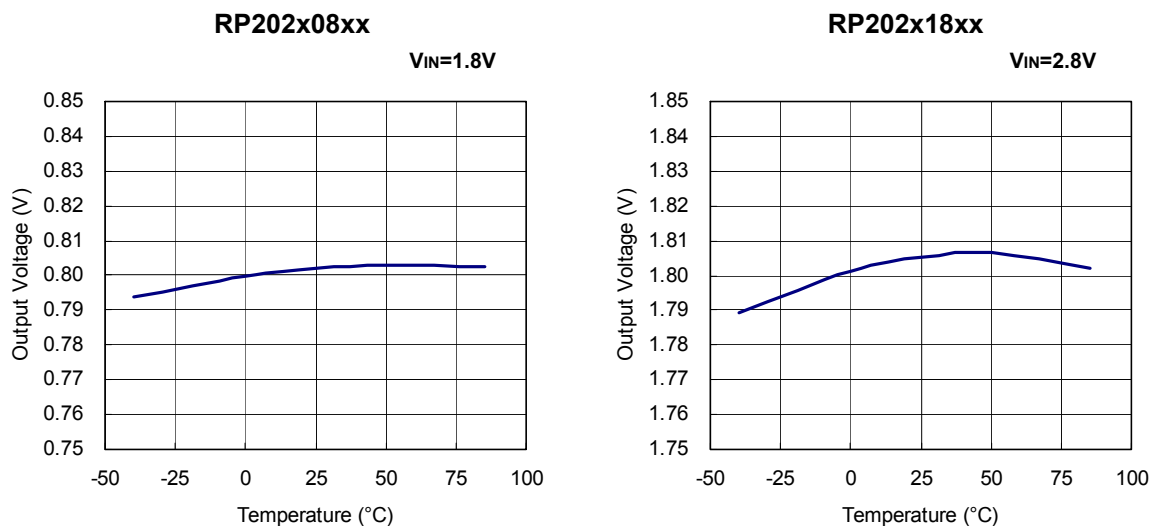

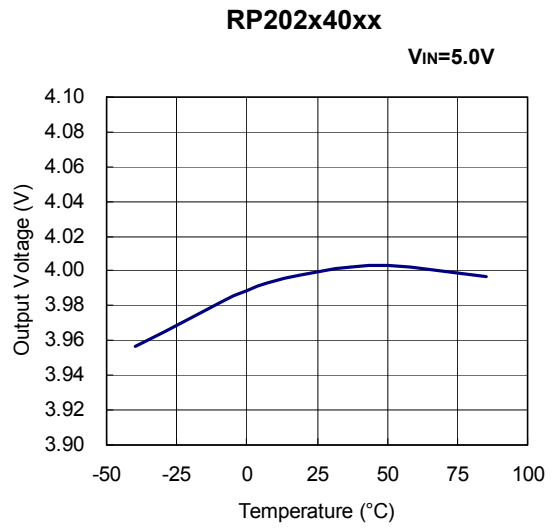
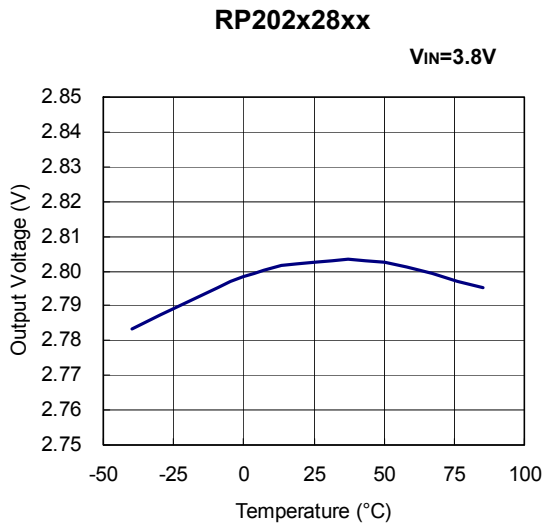

6) Supply Current vs. Temperature ( $C1=0.47\mu F$ ,  $C2=0.47\mu F$ )

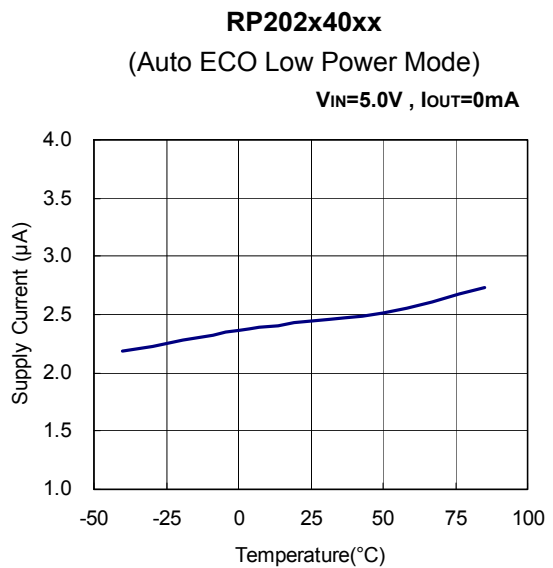
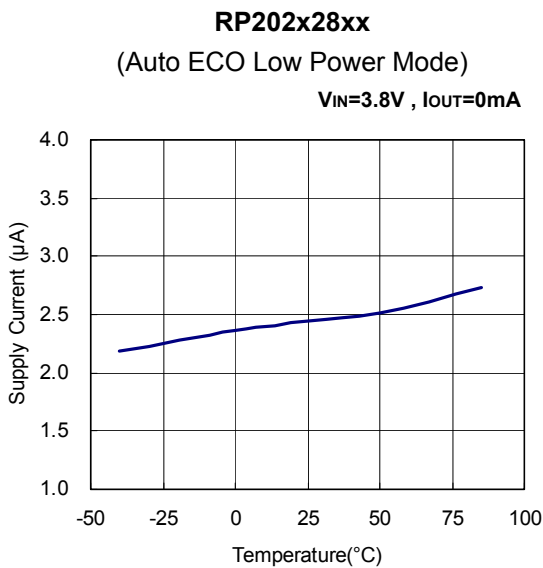
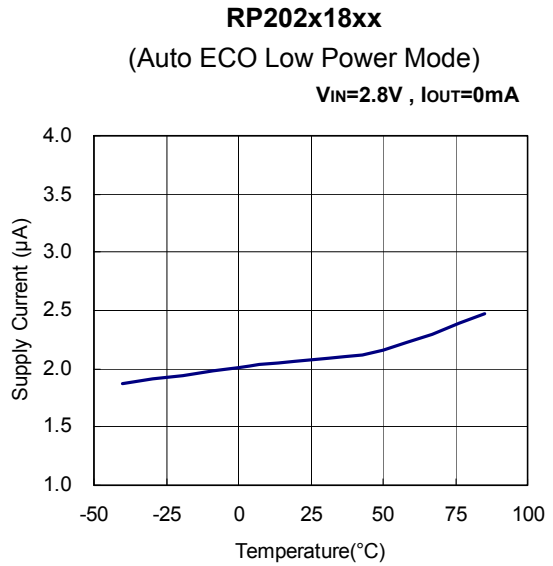
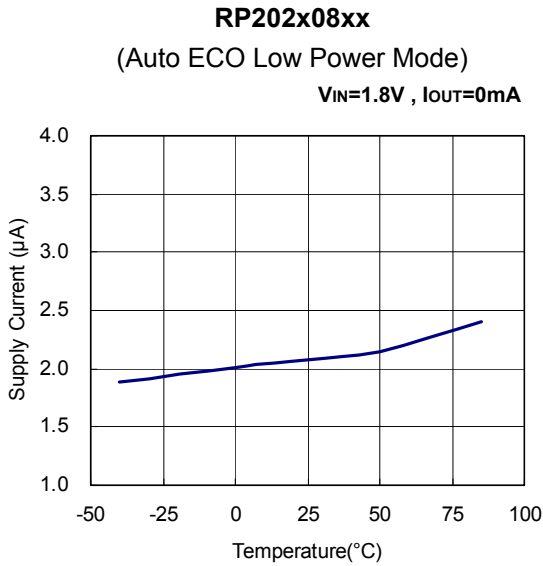

**RP202x08xx**  
(Auto ECO FAST Mode)  
 $V_{IN}=1.8V$ ,  $I_{OUT}=10mA$

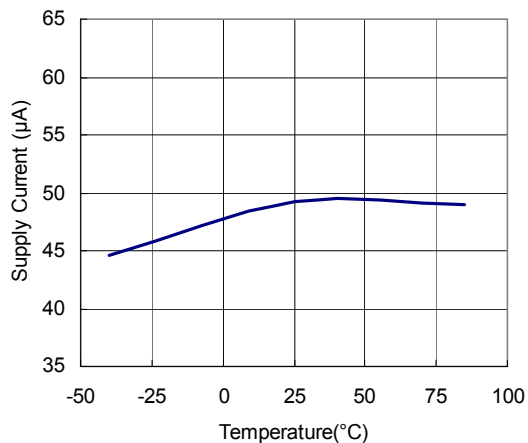

**RP202x18xx**  
(Auto ECO FAST Mode)  
 $V_{IN}=2.8V$ ,  $I_{OUT}=10mA$

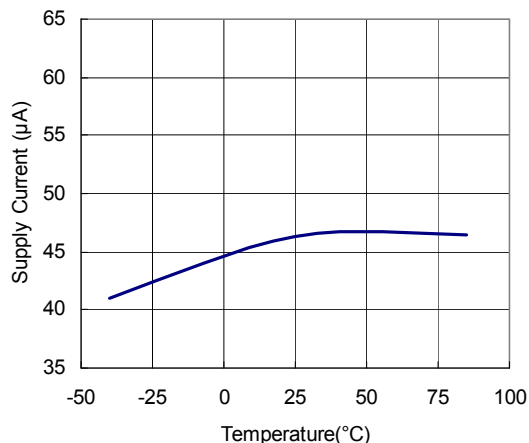

**RP202x28xx**  
(Auto ECO FAST Mode)  
 $V_{IN}=3.8V$ ,  $I_{OUT}=10mA$

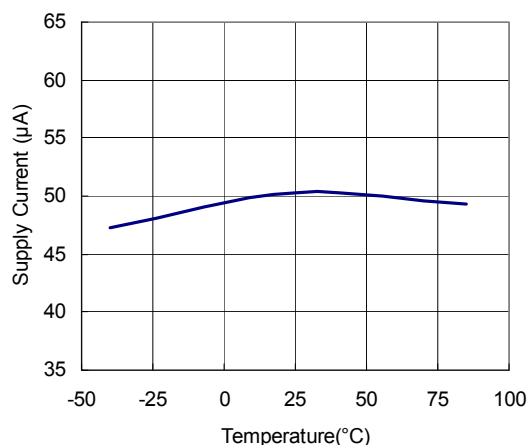

**RP202x40xx**  
(Auto ECO FAST Mode)  
 $V_{IN}=5.0V$ ,  $I_{OUT}=10mA$

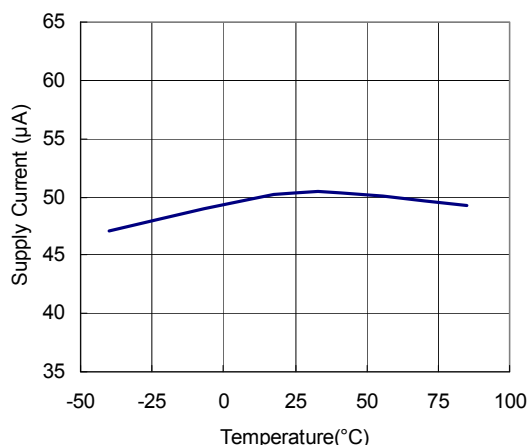

7) Dropout Voltage vs. Output Current ( $C1=0.47\mu F$ ,  $C2=0.47\mu F$ )

**RP202x08xx**

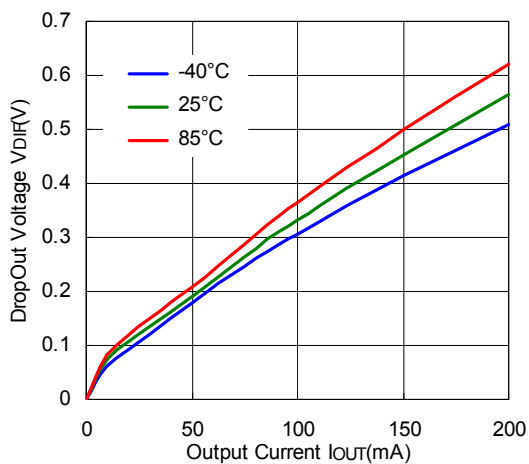

**RP202x10xx**

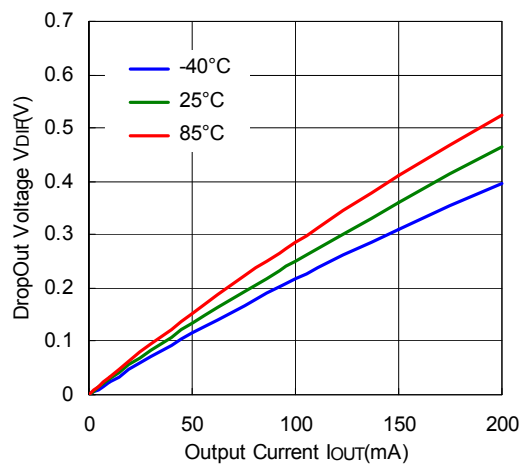

RP202x12xx

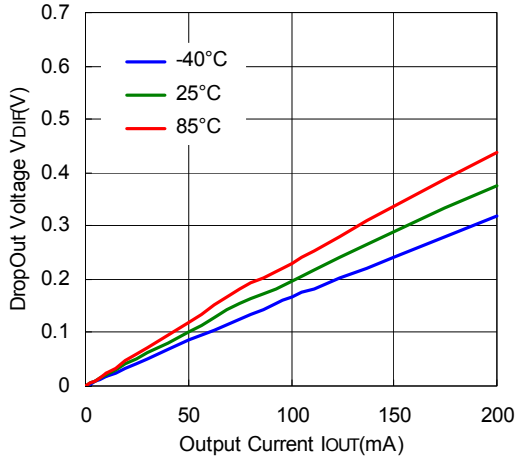

RP202x15xx

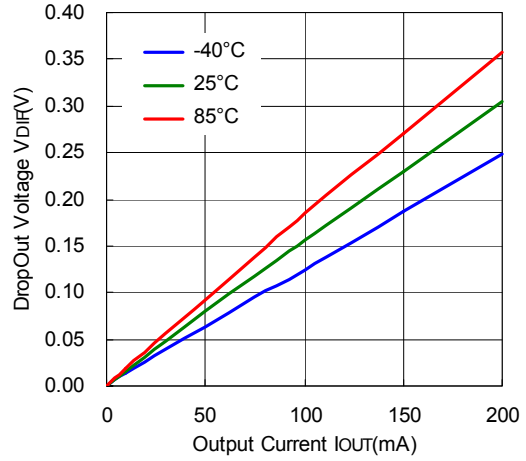

RP202x18xx

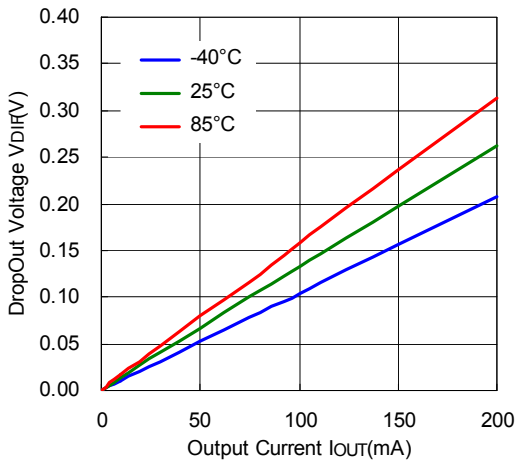

RP202x21xx

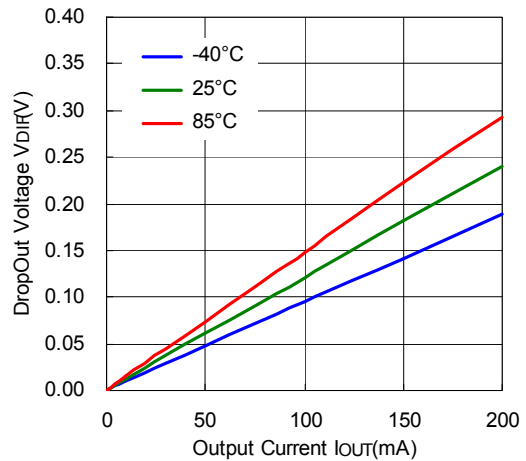

RP202x28xx

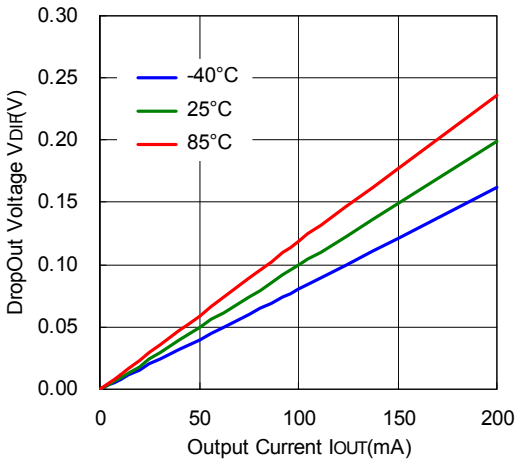

RP202x33xx

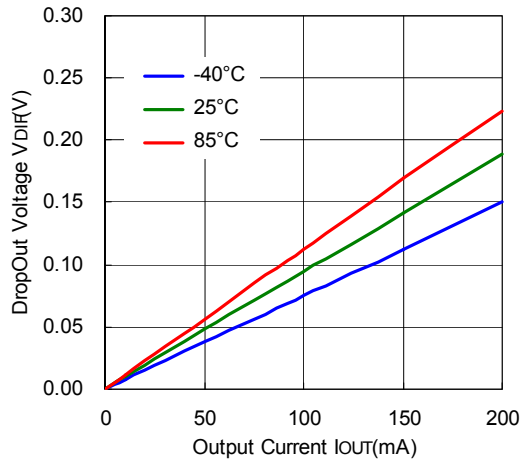

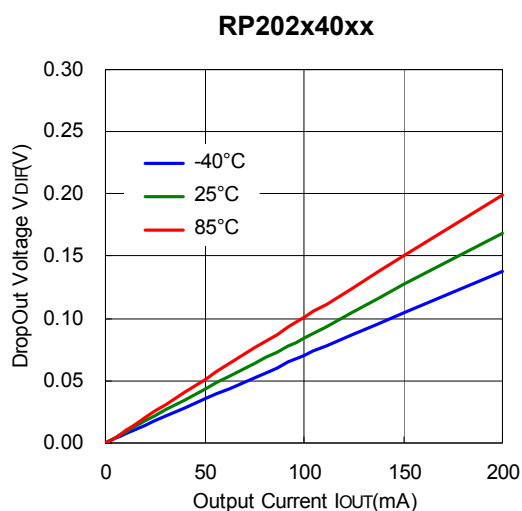

**8) Dropout Voltage vs Set Output Voltage**

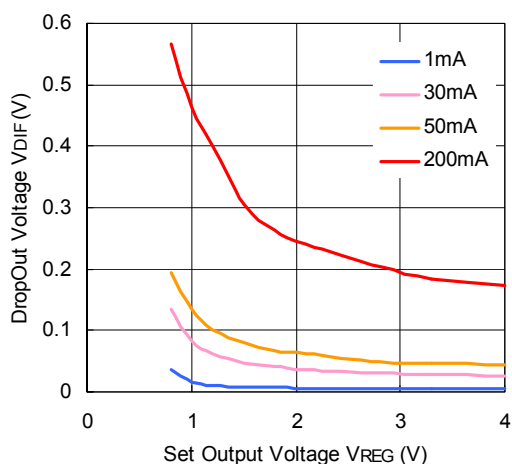

**9) Maximum Output Current vs. Set Output Voltage ( $C1=0.47\mu F$ ,  $C2=0.47\mu F$ ,  $V_{IN}=1.4V$ )**

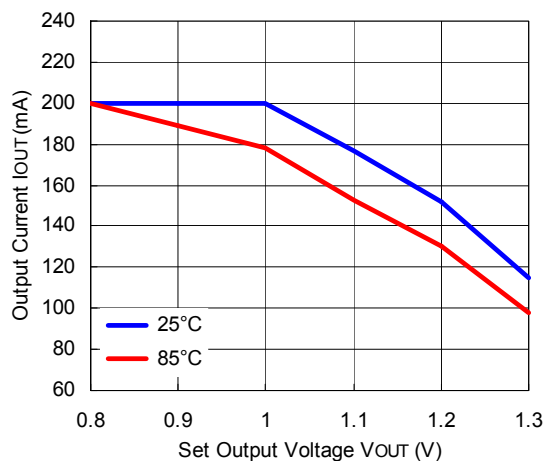

---

**RP202**

NO.EA-279-160324

---



10) Ripple Rejection vs. Input Bias Voltage (C1=none, C2=0.47μF, Ripple=0.2Vp-p, Ta=25°C)

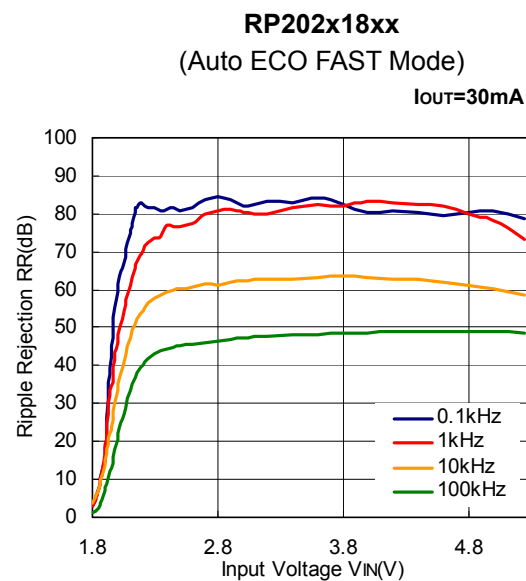
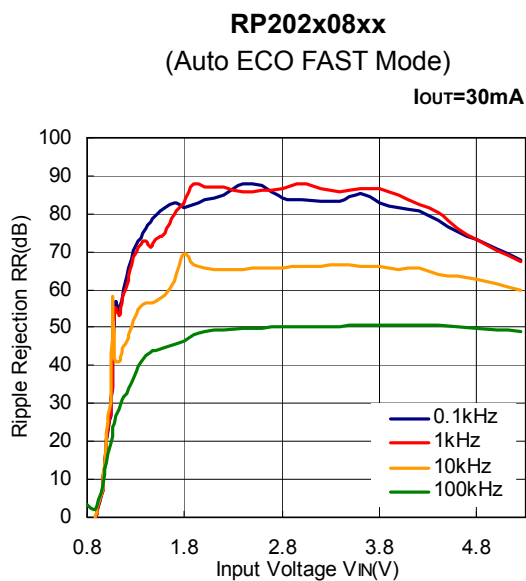
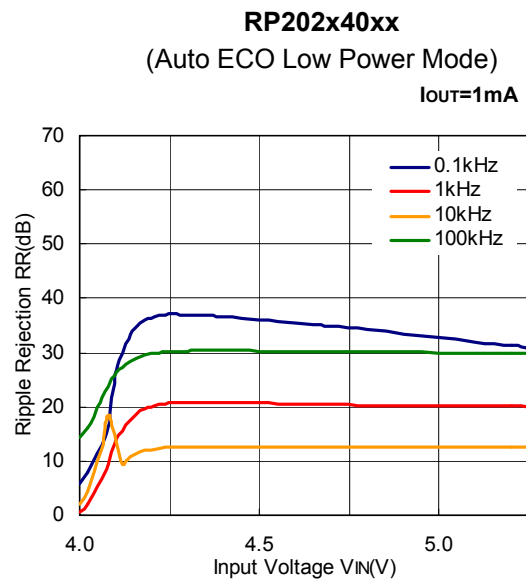
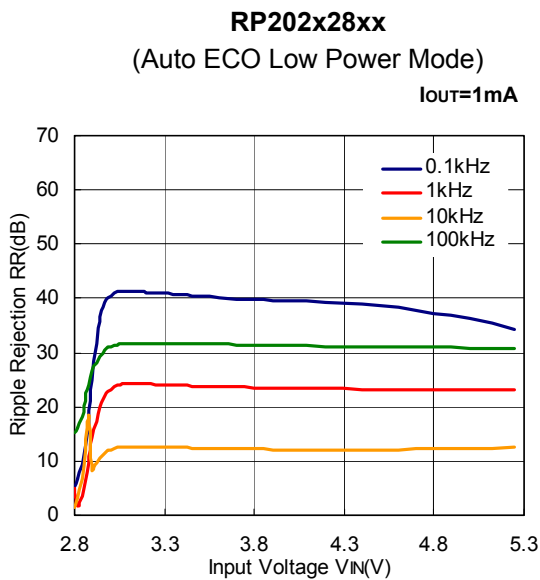
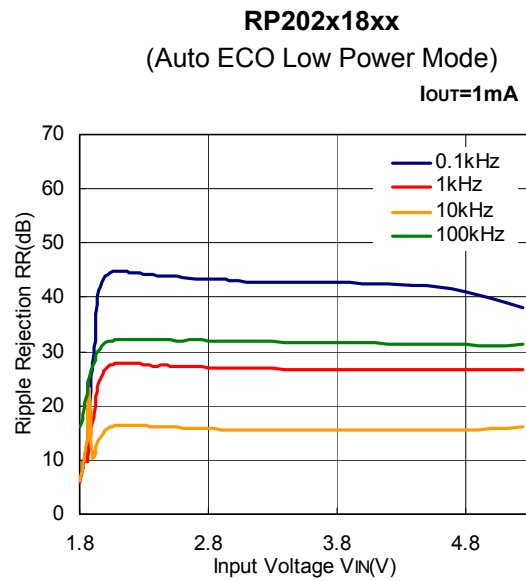
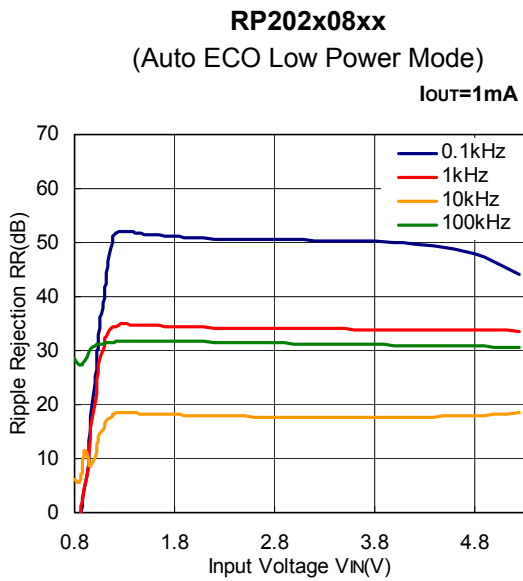

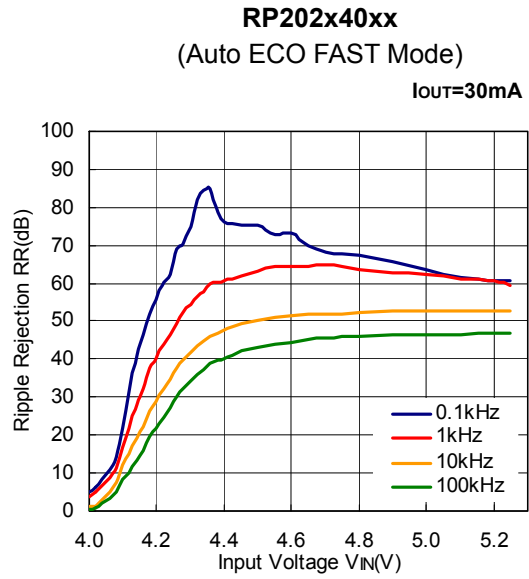
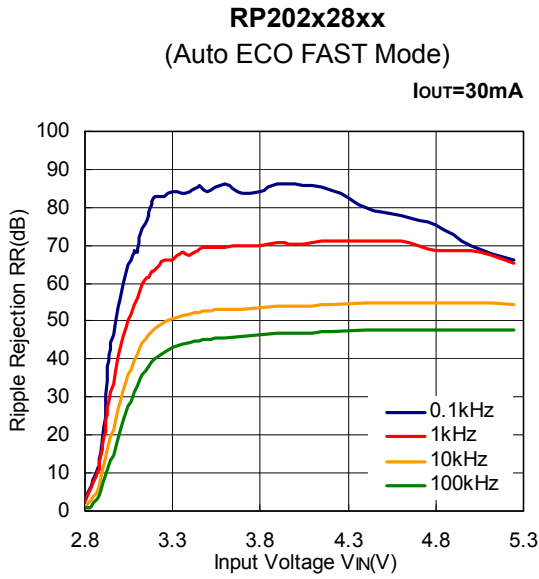

**11) Ripple Rejection vs. Frequency ( $C_1=none, C_2=0.47\mu F, Ripple=0.2Vp-p, T_a=25^\circ C$ )**

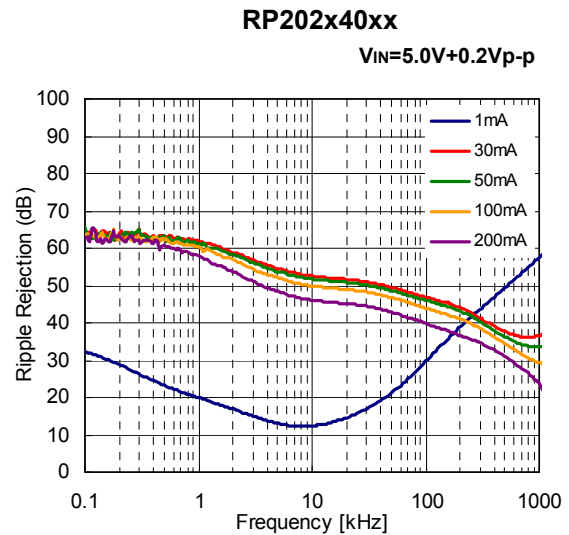
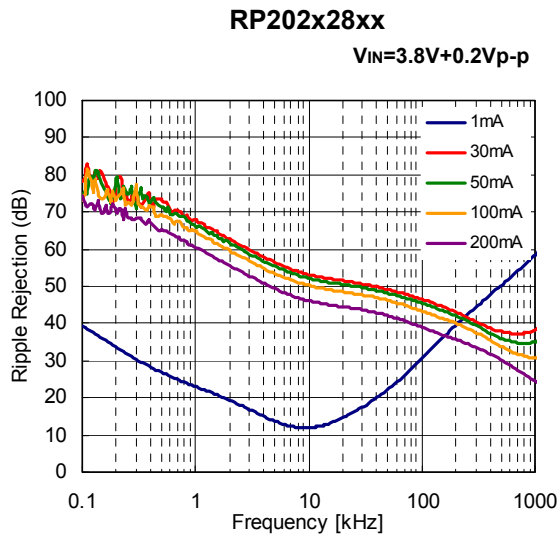
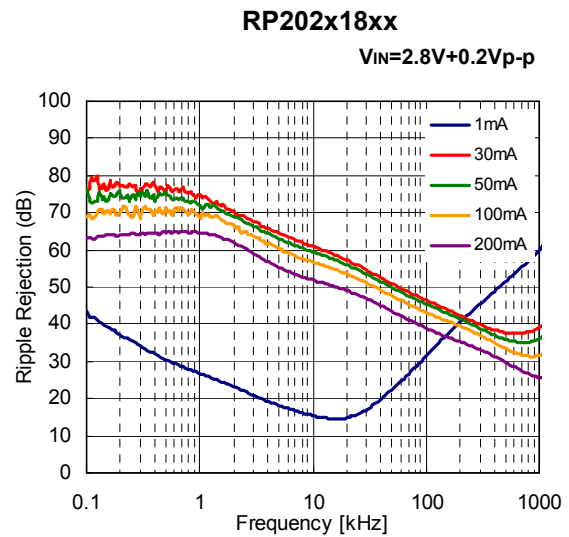
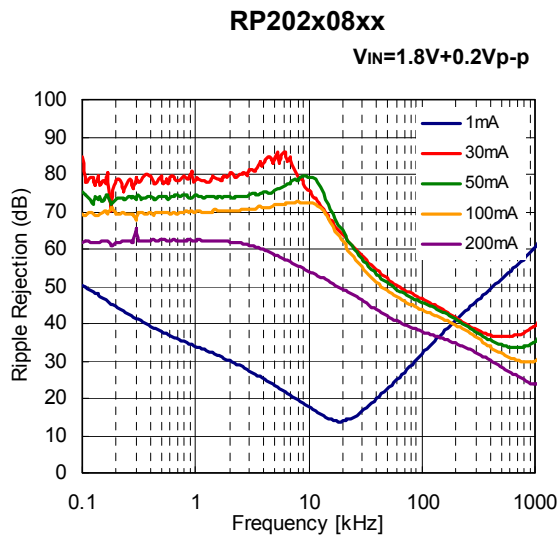

12) Input Transient Response (C1=none, C2=0.47 $\mu$ F, tr=tf=5 $\mu$ s, Ta=25°C)

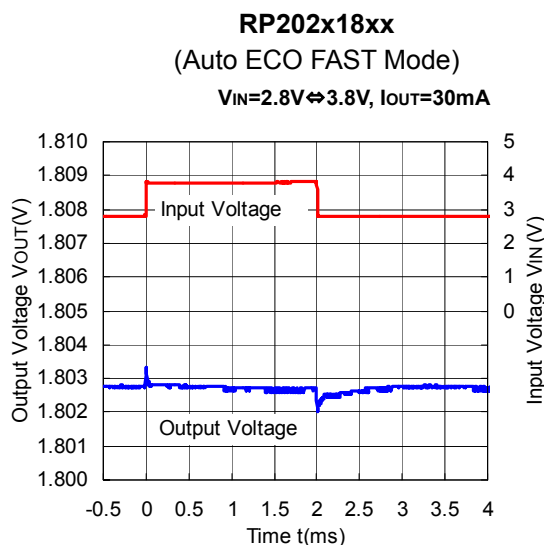
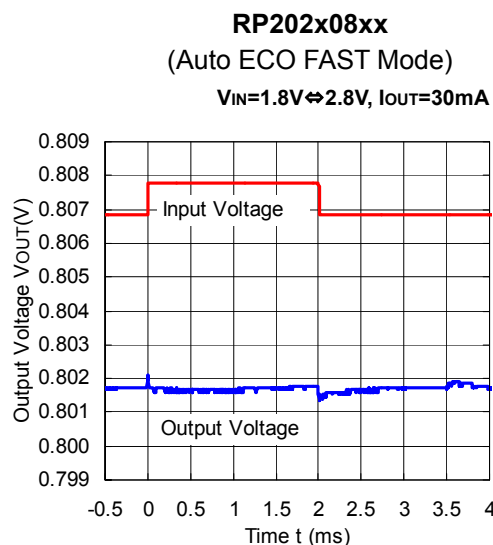
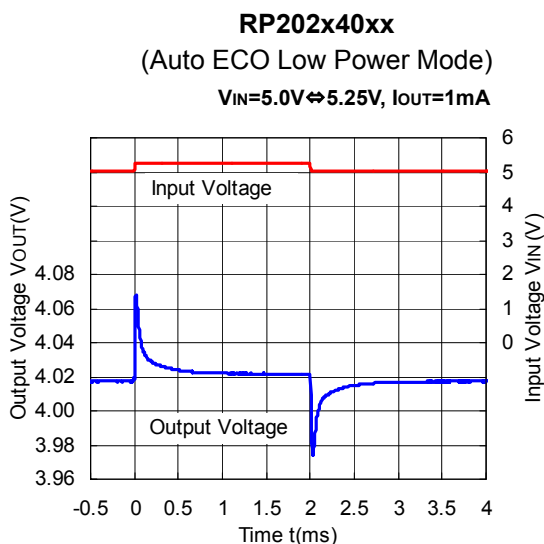
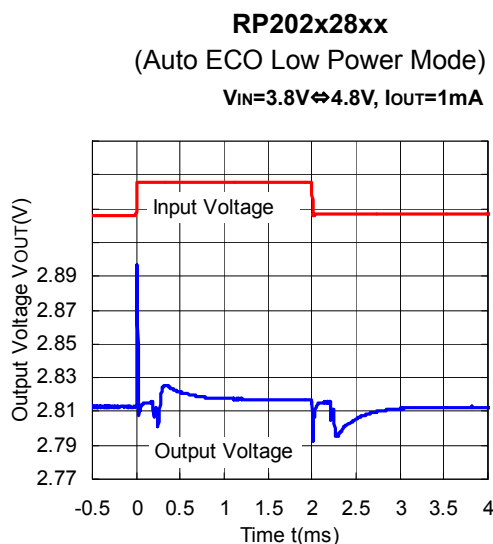
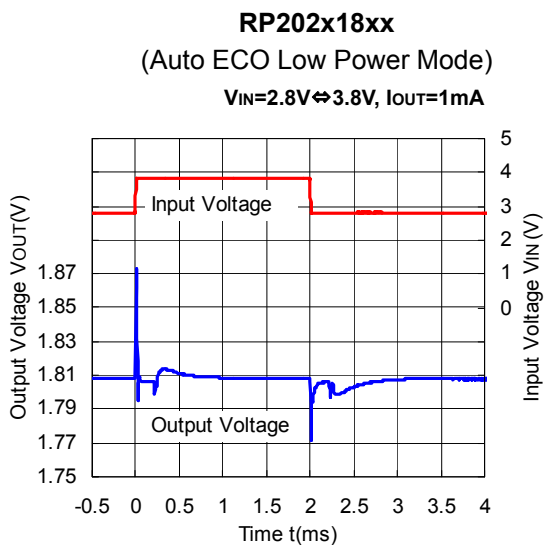
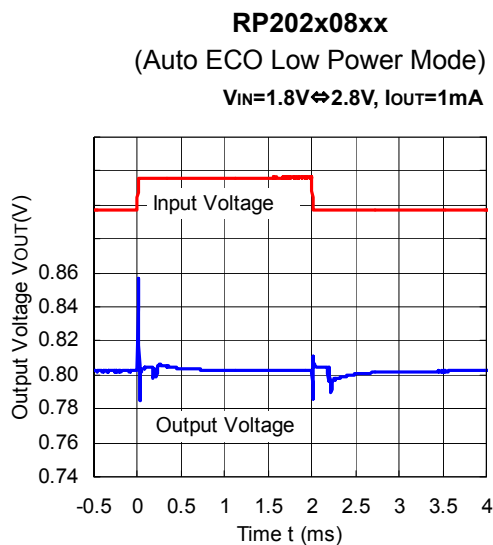

**RP202x28xx**  
(Auto ECO FAST Mode)

V<sub>IN</sub>=3.8V↔4.8V, I<sub>OUT</sub>=30mA

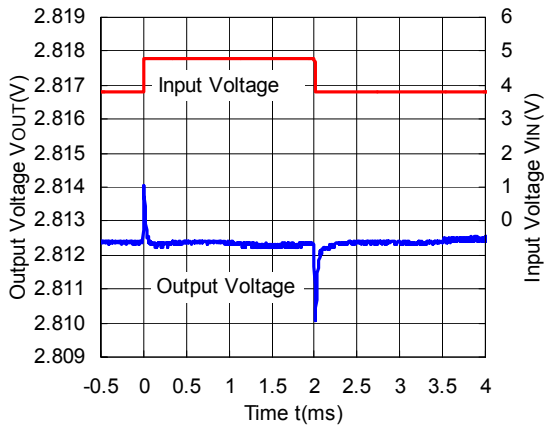

**RP202x40xx**  
(Auto ECO FAST Mode)

V<sub>IN</sub>=5.0V↔5.25V, I<sub>OUT</sub>=30mA

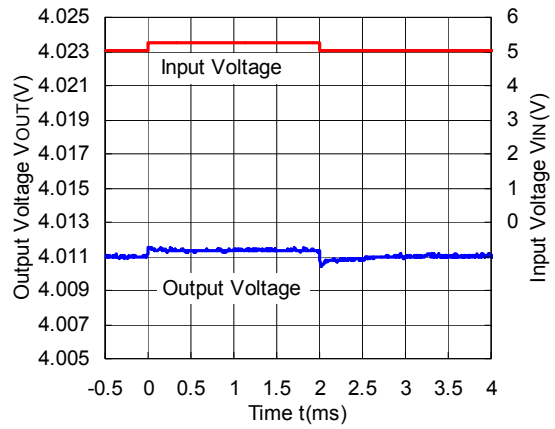

**13) Load Transient Response (C1=0.47μF, C2=0.47μF, tr=tf=0.5μs, Ta=25°C)**

**RP202x08xx**

(Auto ECO Low Power Mode↔FAST Mode)

V<sub>IN</sub>=1.8V

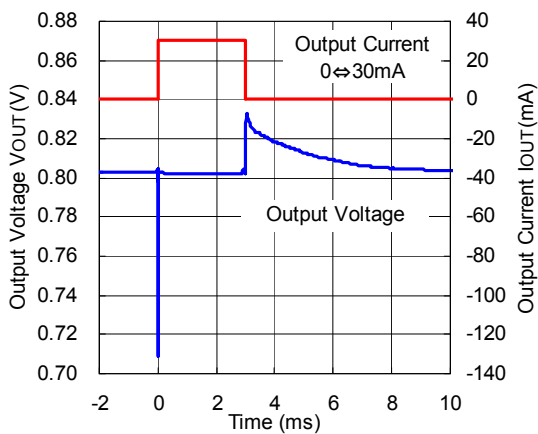

**RP202x18xx**

(Auto ECO Low Power Mode↔FAST Mode)

V<sub>IN</sub>=2.8V

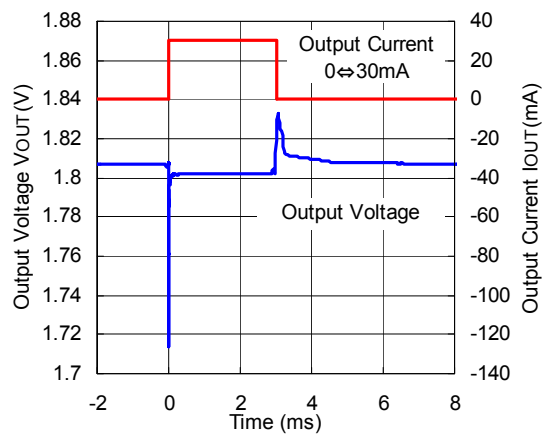

**RP202x28xx**

(Auto ECO Low Power Mode↔FAST Mode)

V<sub>IN</sub>=3.8V

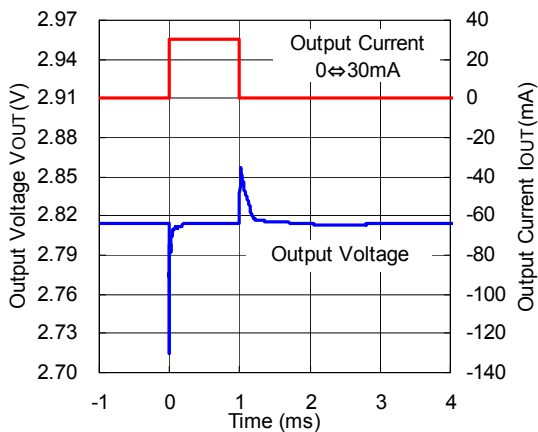

**RP202x40xx**

(Auto ECO Low Power Mode↔FAST Mode)

V<sub>IN</sub>=5.0V

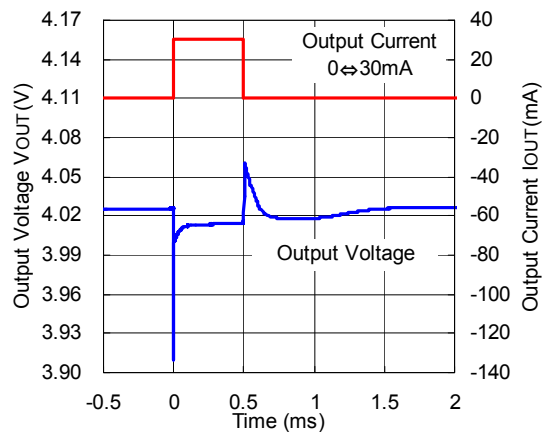

**RP202x08xx**  
(Auto ECO FAST Mode)

V<sub>IN</sub>=1.8V

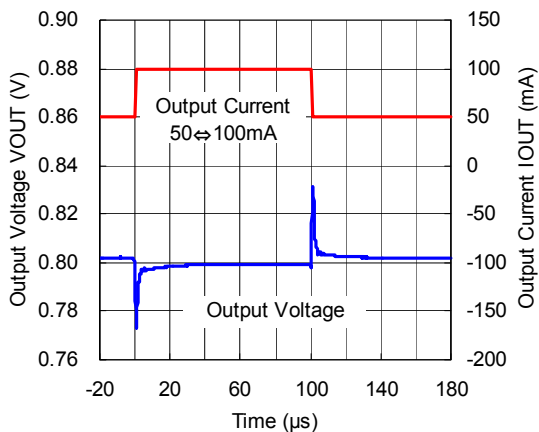

**RP202x18xx**  
(Auto ECO FAST Mode)

V<sub>IN</sub>=2.8V

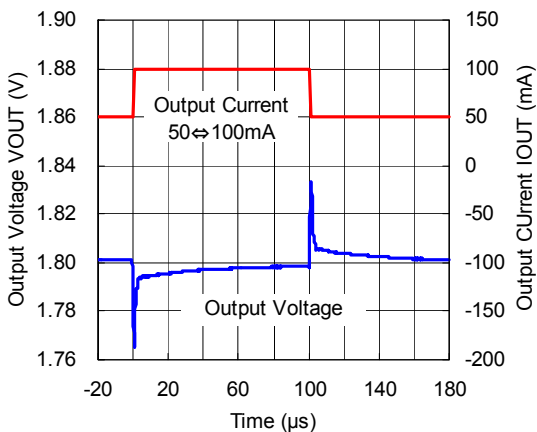

**RP202x28xx**  
(Auto ECO FAST Mode)

V<sub>IN</sub>=3.8V

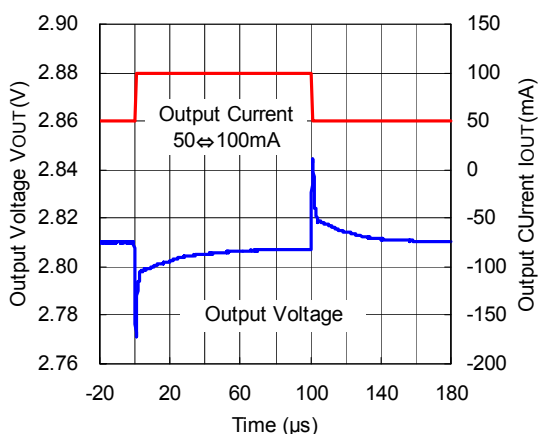

**RP202x40xx**  
(Auto ECO FAST Mode)

V<sub>IN</sub>=5.0V

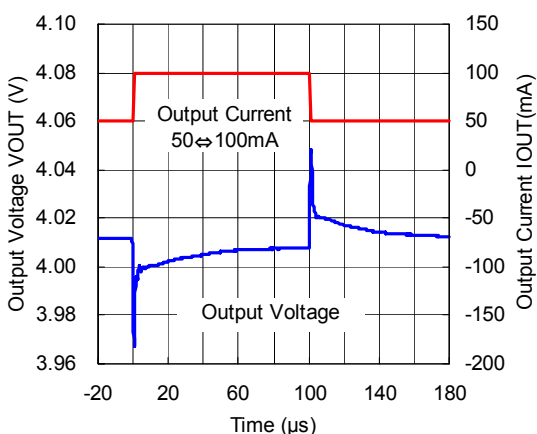

**RP202x08xx**  
(Auto ECO Low Power Mode⇒FAST Mode)

V<sub>IN</sub>=1.8V

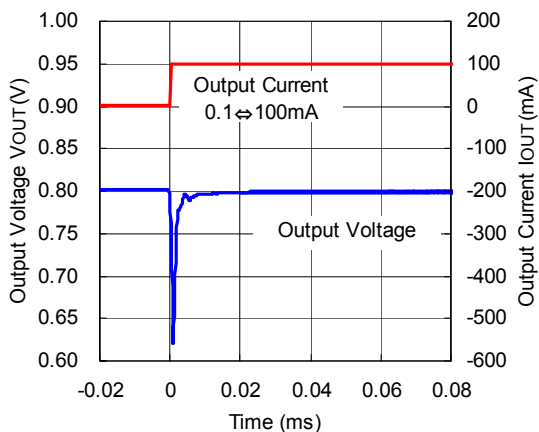

**RP202x18xx**  
(Auto ECO Low Power Mode⇒FAST Mode)

V<sub>IN</sub>=2.8V

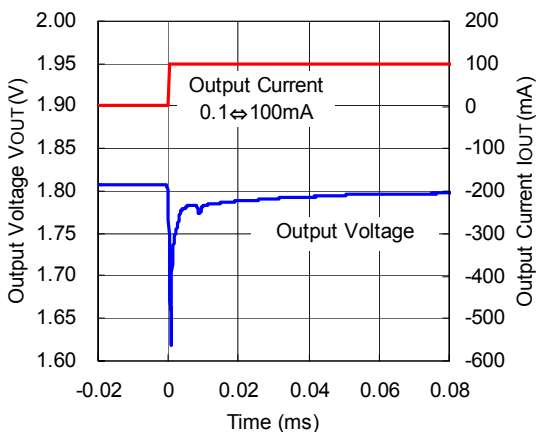

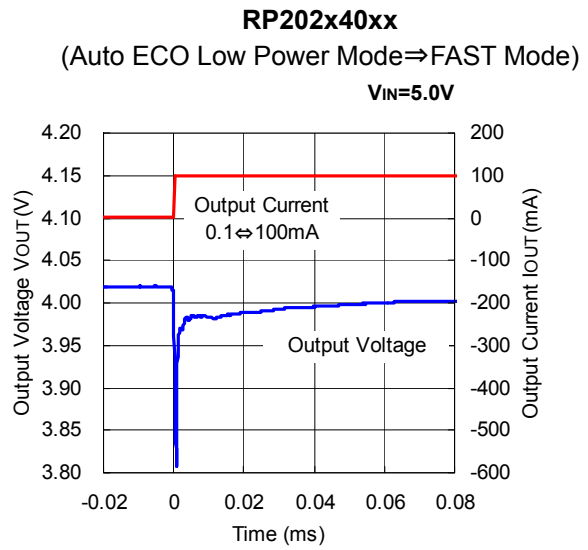
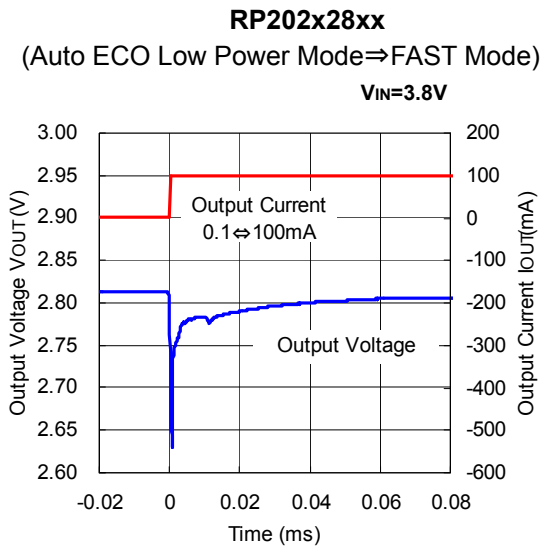

**14) Turn On Waveform (Output Voltage) with CE pin (C1=0.47μF, Ta=25°C)**

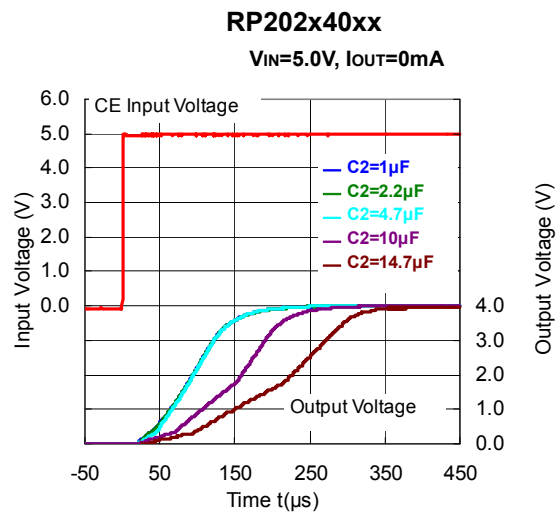
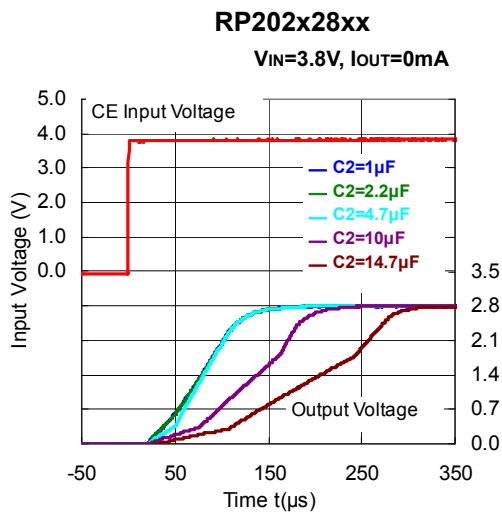
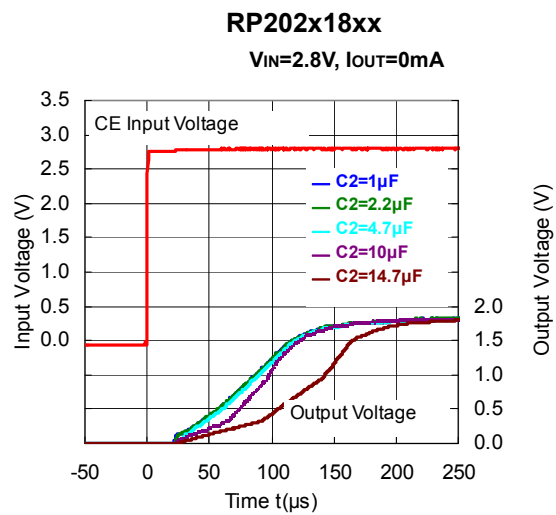
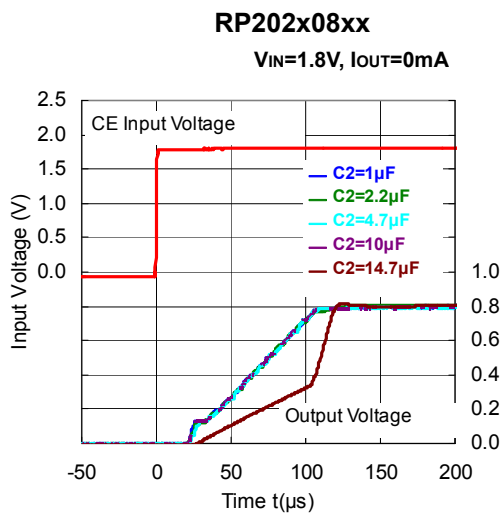

15) Turn On Input Waveform (Input Current) with CE pin ( $C1=0.47\mu\text{F}$ ,  $T_a=25^\circ\text{C}$ )

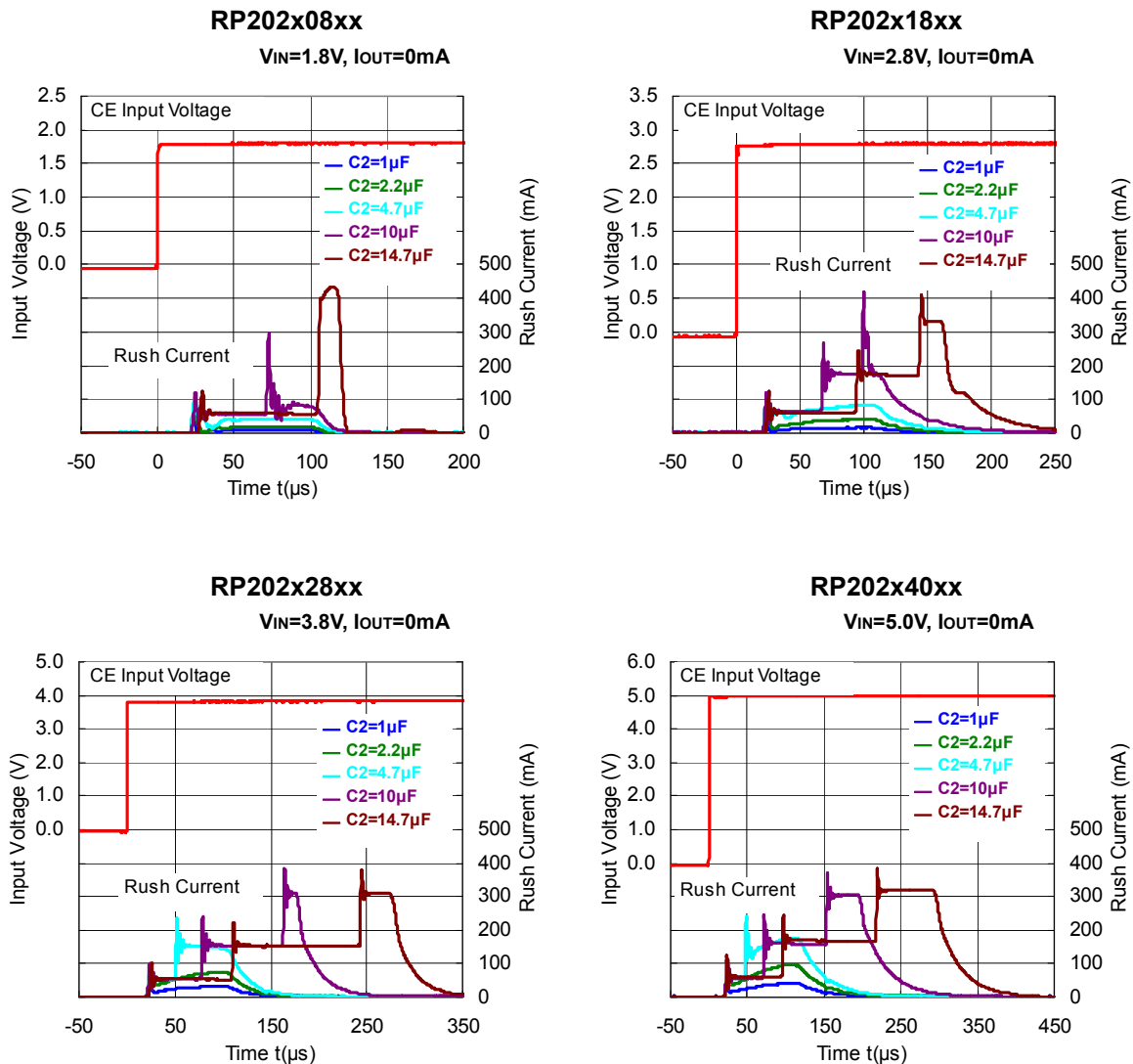

16) Turn On Speed with CE pin (D Version) ( $C1=0.47\mu\text{F}$ ,  $C2=0.47\mu\text{F}$ ,  $T_a=25^\circ\text{C}$ )

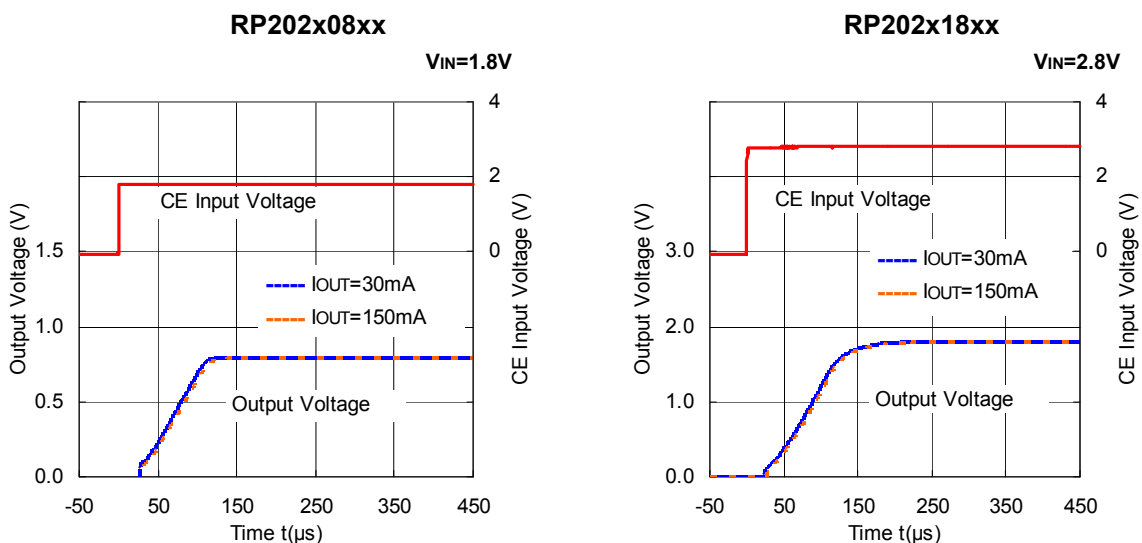

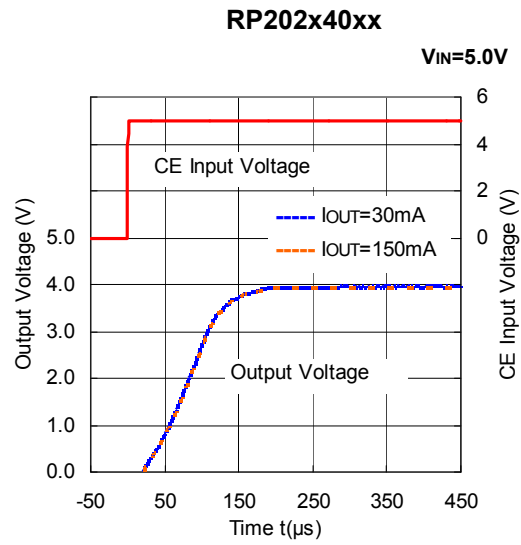
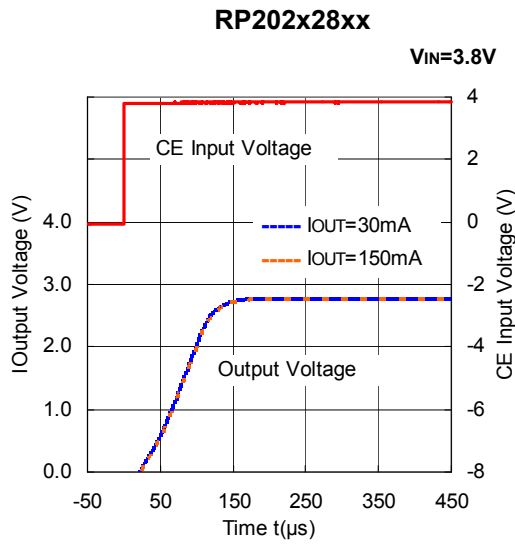

17) Turn Off Speed with CE pin (D Version) ( $C1=0.47\mu F$ ,  $C2=0.47\mu F$ ,  $T_a=25^\circ C$ )

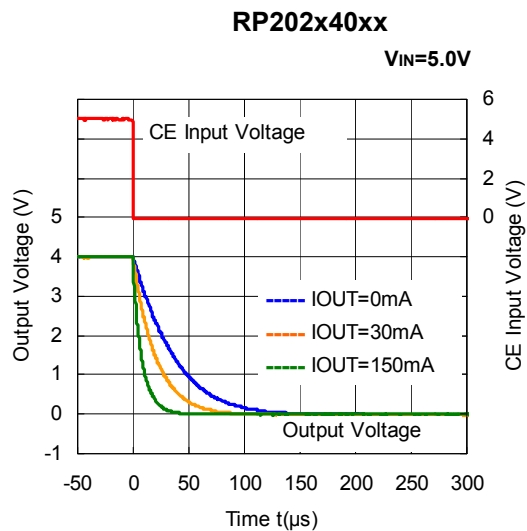
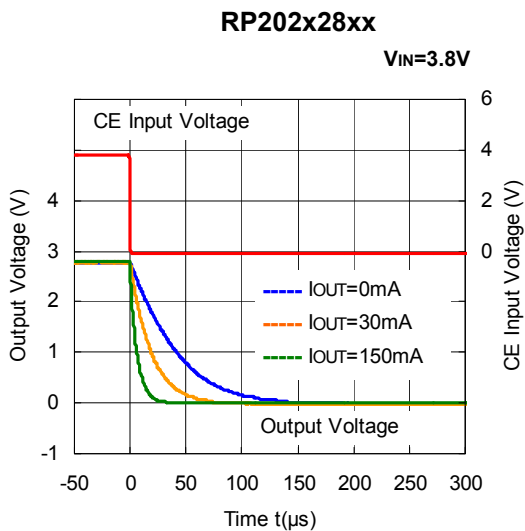
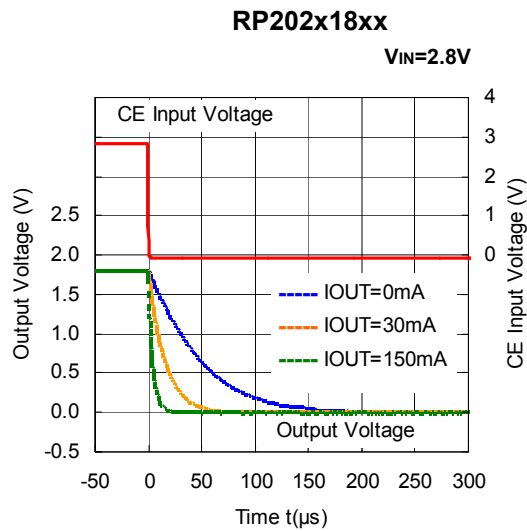
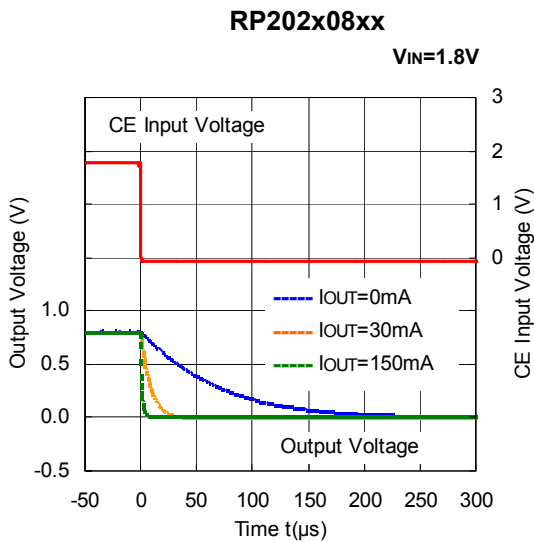



## ESR vs. Output Current

When using these ICs, consider the following points:

The relations between  $I_{OUT}$  (Output Current) and ESR of an output capacitor are shown below.

The conditions when the white noise level is under  $40\mu\text{V}$  (Avg.) are marked as the hatched area in the graph.

### Measurement conditions

Frequency Band: 10Hz to 2MHz

Temperature :  $-40^{\circ}\text{C}$  to  $85^{\circ}\text{C}$

C1, C2 :  $0.47\mu\text{F}$

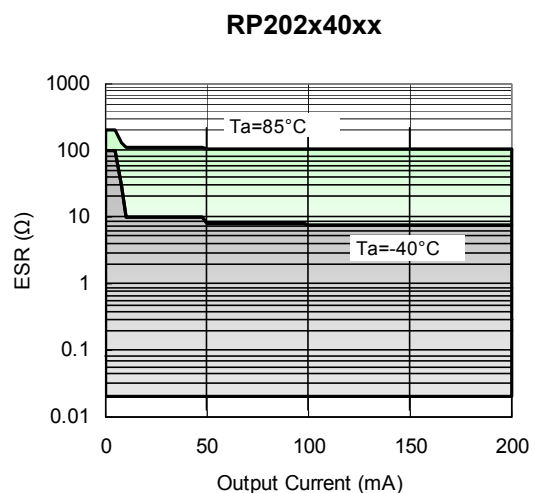
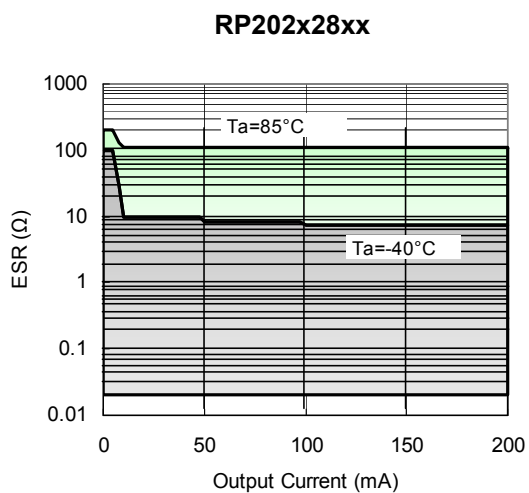
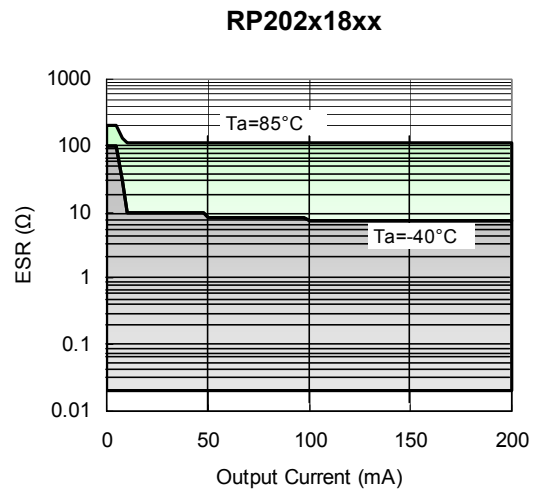
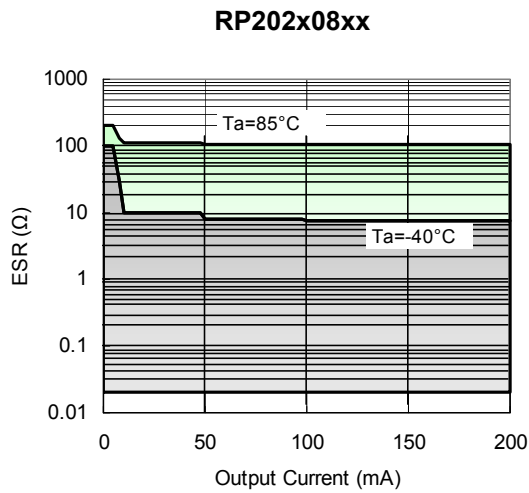



1. The products and the product specifications described in this document are subject to change or discontinuation of production without notice for reasons such as improvement. Therefore, before deciding to use the products, please refer to Ricoh sales representatives for the latest information thereon.
2. The materials in this document may not be copied or otherwise reproduced in whole or in part without prior written consent of Ricoh.
3. Please be sure to take any necessary formalities under relevant laws or regulations before exporting or otherwise taking out of your country the products or the technical information described herein.
4. The technical information described in this document shows typical characteristics of and example application circuits for the products. The release of such information is not to be construed as a warranty of or a grant of license under Ricoh's or any third party's intellectual property rights or any other rights.
5. The products listed in this document are intended and designed for use as general electronic components in standard applications (office equipment, telecommunication equipment, measuring instruments, consumer electronic products, amusement equipment etc.). Those customers intending to use a product in an application requiring extreme quality and reliability, for example, in a highly specific application where the failure or misoperation of the product could result in human injury or death (aircraft, spacevehicle, nuclear reactor control system, traffic control system, automotive and transportation equipment, combustion equipment, safety devices, life support system etc.) should first contact us.
6. We are making our continuous effort to improve the quality and reliability of our products, but semiconductor products are likely to fail with certain probability. In order to prevent any injury to persons or damages to property resulting from such failure, customers should be careful enough to incorporate safety measures in their design, such as redundancy feature, fire containment feature and fail-safe feature. We do not assume any liability or responsibility for any loss or damage arising from misuse or inappropriate use of the products.
7. Anti-radiation design is not implemented in the products described in this document.
8. Please contact Ricoh sales representatives should you have any questions or comments concerning the products or the technical information.



**Ricoh is committed to reducing the environmental loading materials in electrical devices with a view to contributing to the protection of human health and the environment.**

Ricoh has been providing RoHS compliant products since April 1, 2006 and Halogen-free products since April 1, 2012.

**RICOH** RICOH ELECTRONIC DEVICES CO., LTD.

<http://www.e-devices.ricoh.co.jp/en/>

#### Sales & Support Offices

##### **RICOH ELECTRONIC DEVICES CO., LTD.**

**Higashi-Shinagawa Office (International Sales)**  
3-32-3, Higashi-Shinagawa, Shinagawa-ku, Tokyo 140-8655, Japan  
Phone: +81-3-5479-2857 Fax: +81-3-5479-0502

##### **RICOH EUROPE (NETHERLANDS) B.V.**

**Semiconductor Support Centre**  
Prof. W.H. Keesomlaan 1, 1183 DJ Amstelveen, The Netherlands  
Phone: +31-20-5474-309

##### **RICOH INTERNATIONAL B.V. - German Branch**

**Semiconductor Sales and Support Centre**  
Oberrather Strasse 6, 40472 Düsseldorf, Germany  
Phone: +49-211-6546-0

##### **RICOH ELECTRONIC DEVICES KOREA CO., LTD.**

3F, Haesung Bldg, 504, Teheran-ro, Gangnam-gu, Seoul, 135-725, Korea  
Phone: +82-2-2135-5700 Fax: +82-2-2051-5713

##### **RICOH ELECTRONIC DEVICES SHANGHAI CO., LTD.**

Room 403, No.2 Building, No.690 Bibo Road, Pu Dong New District, Shanghai 201203, People's Republic of China  
Phone: +86-21-5027-3200 Fax: +86-21-5027-3299

##### **RICOH ELECTRONIC DEVICES CO., LTD.**

**Taipei office**  
Room 109, 10F-1, No.51, Hengyang Rd., Taipei City, Taiwan (R.O.C.)  
Phone: +886-2-2313-1621/1622 Fax: +886-2-2313-1623

# Mouser Electronics

Authorized Distributor

Click to View Pricing, Inventory, Delivery & Lifecycle Information:

## Ricoh Electronics:

[RP202N181D-TR-FE](#) [RP202K301D-TR](#) [RP202K251D-TR](#) [RP202K151D-TR](#) [RP202K181D-TR](#) [RP202K331D-TR](#)  
[RP202K281D-TR](#)

Компания «Океан Электроники» предлагает заключение долгосрочных отношений при поставках импортных электронных компонентов на взаимовыгодных условиях!

Наши преимущества:

- Поставка оригинальных импортных электронных компонентов напрямую с производств Америки, Европы и Азии, а так же с крупнейших складов мира;
- Широкая линейка поставок активных и пассивных импортных электронных компонентов (более 30 млн. наименований);
- Поставка сложных, дефицитных, либо снятых с производства позиций;
- Оперативные сроки поставки под заказ (от 5 рабочих дней);
- Экспресс доставка в любую точку России;
- Помощь Конструкторского Отдела и консультации квалифицированных инженеров;
- Техническая поддержка проекта, помощь в подборе аналогов, поставка прототипов;
- Поставка электронных компонентов под контролем ВП;
- Система менеджмента качества сертифицирована по Международному стандарту ISO 9001;
- При необходимости вся продукция военного и аэрокосмического назначения проходит испытания и сертификацию в лаборатории (по согласованию с заказчиком);
- Поставка специализированных компонентов военного и аэрокосмического уровня качества (Xilinx, Altera, Analog Devices, Intersil, Interpoint, Microsemi, Actel, Aeroflex, Peregrine, VPT, Syfer, Eurofarad, Texas Instruments, MS Kennedy, Miteq, Cobham, E2V, MA-COM, Hittite, Mini-Circuits, General Dynamics и др.);

Компания «Океан Электроники» является официальным дистрибьютором и эксклюзивным представителем в России одного из крупнейших производителей разъемов военного и аэрокосмического назначения «JONHON», а так же официальным дистрибьютором и эксклюзивным представителем в России производителя высокотехнологичных и надежных решений для передачи СВЧ сигналов «FORSTAR».



## JONHON

«JONHON» (основан в 1970 г.)

Разъемы специального, военного и аэрокосмического назначения:

(Применяются в военной, авиационной, аэрокосмической, морской, железнодорожной, горно- и нефтедобывающей отраслях промышленности)

«FORSTAR» (основан в 1998 г.)

ВЧ соединители, коаксиальные кабели, кабельные сборки и микроволновые компоненты:

(Применяются в телекоммуникациях гражданского и специального назначения, в средствах связи, РЛС, а так же военной, авиационной и аэрокосмической отраслях промышленности).



Телефон: 8 (812) 309-75-97 (многоканальный)

Факс: 8 (812) 320-03-32

Электронная почта: [ocean@oceanchips.ru](mailto:ocean@oceanchips.ru)

Web: <http://oceanchips.ru/>

Адрес: 198099, г. Санкт-Петербург, ул. Калинина, д. 2, корп. 4, лит. А