

## Voltage Detector with Delay Time Adjustable

## ■ GENERAL DESCRIPTION

The XC6119 series is a highly precise, low power consumption voltage detector, manufactured using CMOS and laser trimming technologies.

The device includes the built-in delay circuit. A release delay time can be set freely by connecting an external delay capacitor to the Cd pin.

The device using an ultra small package (USPN-4) is suited for high density mounting applications. Both CMOS and N-channel open drain output configurations are available.

## ■ APPLICATIONS

- Microprocessor reset circuitry
- Charge voltage monitors
- Memory battery back-up switch circuits
- Power failure detection circuits

## ■ FEATURES

<b>High Accuracy</b>	: $\pm 2\%$ (Detection Voltage $\geq 1.5V$ ) $\pm 30mV$ (Detection Voltage $< 1.5V$ )
<b>Low Power Consumption</b>	: $0.5 \mu A$ TYP. in detect state ( $V_{DF}=1.0V$ , $V_{IN}=0.9V$ ) $0.9 \mu A$ TYP. in release state ( $V_{DF}=1.0V$ , $V_{IN}=1.1V$ )
<b>Detect Voltage Options</b>	: $0.8V \sim 5.0V$ (0.1V increments)
<b>Operating Voltage Range</b>	: $0.7V \sim 6.0V$
<b>Detect Voltage Temperature Characteristics</b>	: $\pm 100ppm/^{\circ}C$ TYP.
<b>Output Configuration</b>	: CMOS or N-channel open drain
<b>Built-In Delay Circuit</b>	: Delay Time Adjustable
<b>Operating Ambient Temperature</b>	: $-40^{\circ}C \sim +85^{\circ}C$
<b>Packages</b>	: SSOT-24, USPN-4
<b>Environmentally Friendly</b>	: EU RoHS Compliant, Pb Free

## ■ TYPICAL APPLICATION CIRCUIT ■ TYPICAL PERFORMANCE CHARACTERISTICS

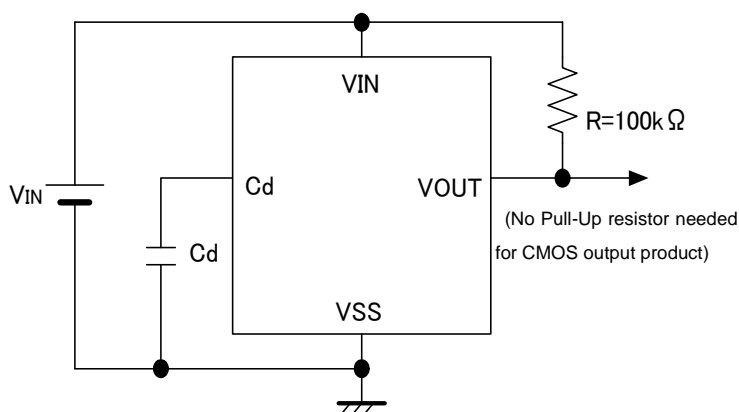

## ● Release Delay Time vs. Delay Capacitance

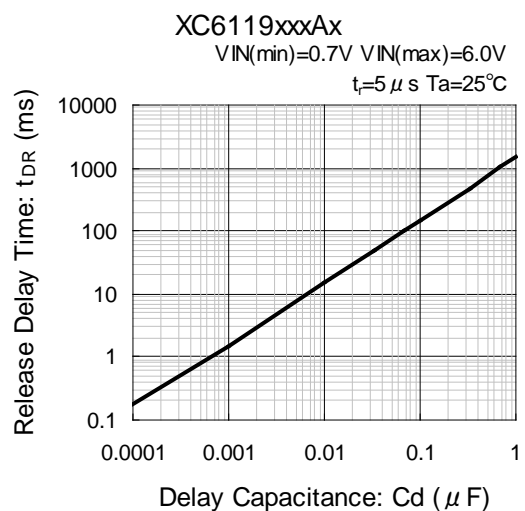

## ■ BLOCK DIAGRAMS

(1) XC6119C (CMOS Output)



(2) XC6119N (N-ch Open Drain Output)



\* Diodes inside the circuits are ESD protection diodes and parasitic diodes.

## ■ PRODUCT CLASSIFICATION

### ● Ordering Information

XC6119①②③④⑤⑥-⑦<sup>(\*)</sup>

DESIGNATOR	ITEM	SYMBOL	DESCRIPTION
①	Output Configuration	C	CMOS output
		N	N-ch open drain output
②③	Detect Voltage	08 ~ 50	e.g. 18→1.8V
④	Output Delay & Hysteresis	A	Built-in delay pin & hysteresis 5% (TYP.)
⑤⑥-⑦	Packages (Order Unit)	7R-G	USPN-4 (5,000pcs/Reel)
		NR-G	SSOT-24 (3,000pcs/Reel)

(\*) The "-G" suffix denotes Halogen and Antimony free as well as being fully EU RoHS compliant.

## ■ PIN CONFIGURATION



## ■ PIN ASSIGNMENT

PIN NUMBER		PIN NAME	FUNCTION
USPN-4	SSOT-24		
1	4	V <sub>OUT</sub>	Output (Detect "L")
2	3	Cd	Delay Capacitance
3	2	V <sub>SS</sub>	Ground
4	1	V <sub>IN</sub>	Input

## PIN FUNCTIONS ASSIGNMENT

V <sub>IN</sub>	V <sub>CD</sub>	V <sub>OUT</sub> transition *		
		①		②
L	L	L	⇒	L
	H			
	L	H		
	H			
H	L	L	⇒	L
	H		⇒	
	L	H	⇒	H
	H		⇒	

\* Function State Transition Example

- 1) When V<sub>OUT</sub> is "L", V<sub>OUT</sub> changes from "L" to "H" when V<sub>IN</sub> = "H" (V<sub>DR</sub> ≤ V<sub>IN</sub>) and V<sub>CD</sub> = "H" (V<sub>TCD</sub> ≤ V<sub>CD</sub>).
- 2) When V<sub>OUT</sub> changes from "H" to "L" and V<sub>IN</sub> = "H" and V<sub>CD</sub> = "L" when V<sub>OUT</sub> is "H", V<sub>OUT</sub> holds "H".

### PIN LOGIC CONDITIONS

(1) XC6119C(CMOS)

PIN NAME	LOGIC	CONDITIONS
V <sub>IN</sub>	L	$V_{IN} \leq V_{DF}$
	H	$V_{IN} \geq V_{DF} + V_{HYS}$
C <sub>d</sub>	L	$0 < V_{CD} < V_{IN}/2 - 0.1$
	H	$V_{IN}/2 + 0.1 \leq V_{CD} \leq V_{IN}$
V <sub>OUT</sub>	L	$V_{OUT} \leq V_{IN} \times 0.1$
	H	$V_{OUT} \geq V_{IN} \times 0.9$

(2) XC6119N(Nch open drain output)

PIN NAME	LOGIC	CONDITIONS
V <sub>IN</sub>	L	$V_{IN} \leq V_{DF}$
	H	$V_{IN} \geq V_{DF} + V_{HYS}$
C <sub>d</sub>	L	$0 < V_{CD} < V_{IN}/2 - 0.1$
	H	$V_{IN}/2 + 0.1 \leq V_{CD} \leq V_{IN}$
V <sub>OUT</sub>	L	$V_{OUT} \leq \text{Pull-Up voltage} \times 0.1$
	H	$V_{OUT} \geq \text{Pull-Up voltage} \times 0.9$

## ABSOLUTE MAXIMUM RATINGS

T<sub>a</sub>=25°C

PARAMETER	SYMBOL	RATINGS	UNITS
Input Voltage	V <sub>IN</sub>	V <sub>SS</sub> -0.3~+7.0	V
Output Current	I <sub>OUT</sub>	10	mA
Output Voltage	XC6119C <sup>(*)1</sup>	V <sub>SS</sub> -0.3~V <sub>IN</sub> +0.3	V
	XC6119N <sup>(*)2</sup>	V <sub>SS</sub> -0.3~+7.0	
Delay Pin Voltage	V <sub>CD</sub>	V <sub>SS</sub> -0.3~V <sub>IN</sub> +0.3	V
Delay Pin Current	I <sub>CD</sub>	5.0	mA
Power Dissipation	USPN-4	100	mW
		600(40mm x 40mm Standard board) <sup>(*)3</sup>	
	SSOT-24	150	
		500 (40mm x 40mm Standard board) <sup>(*)3</sup>	
Operating Ambient Temperature	T <sub>a</sub>	-40~+85	°C
Storage Temperature	T <sub>stg</sub>	-55~+125	°C

NOTE:

<sup>(\*)1</sup> CMOS output

<sup>(\*)2</sup> N-ch open drain output

<sup>(\*)3</sup> The power dissipation figure shown is PCB mounted and is for reference only.  
The mounting condition is please refer to PACKAGING INFORMATION.

## ELECTRICAL CHARACTERISTICS

Ta=25°C

PARAMETER		SYMBOL	CONDITIONS	MIN.	TYP.	MAX.	UNIT	CIRCUIT
Operating Voltage		V <sub>IN</sub>	V <sub>DF(T)</sub> =0.8~5.0V <sup>(*)</sup>	0.7		6.0	V	-
Detect Voltage		V <sub>DF</sub>	V <sub>DF(T)</sub> =0.8~5.0V	E-1			V	①
Hysteresis Width		V <sub>HYS</sub>	V <sub>IN</sub> =1.0~6.0V	V <sub>DF</sub> × 0.02	V <sub>DF</sub> × 0.05	V <sub>DF</sub> × 0.08	V	①
Supply Current 1		I <sub>SS1</sub>	V <sub>IN</sub> =V <sub>DF</sub> × 0.9 V <sub>DF(T)</sub> =0.8~1.9V V <sub>DF(T)</sub> =2.0~3.9V V <sub>DF(T)</sub> =4.0~5.0V		0.5 0.6 0.7	1.2 1.3 1.4	μA	②
Supply Current 2		I <sub>SS2</sub>	V <sub>IN</sub> =V <sub>DF</sub> × 1.1 V <sub>DF(T)</sub> =0.8~1.9V V <sub>DF(T)</sub> =2.0~3.9V V <sub>DF(T)</sub> =4.0~5.0V		0.9 1.1 1.2	1.8 2.0 2.2	μA	②
Output Current		I <sub>OUT1</sub>	V <sub>IN</sub> =0.7V V <sub>DS</sub> =0.5V(Nch)	0.01	0.36		mA	③
			V <sub>IN</sub> =1.0V <sup>(*)2</sup> V <sub>DS</sub> =0.5V(Nch)	0.1	0.7			
			V <sub>IN</sub> =2.0V <sup>(*)3</sup> V <sub>DS</sub> =0.5V(Nch)	0.8	1.6			
			V <sub>IN</sub> =3.0V <sup>(*)4</sup> V <sub>DS</sub> =0.5V(Nch)	1.2	2.0			
			V <sub>IN</sub> =4.0V <sup>(*)5</sup> V <sub>DS</sub> =0.5V(Nch)	1.6	2.3			
		I <sub>OUT2</sub> <sup>(*)6</sup>	V <sub>IN</sub> =V <sub>DF</sub> × 1.1 V <sub>DS</sub> =0.5V(Pch)	E-2				mA
Leakage Current	CMOS output (P-ch)	I <sub>LEAK</sub>	V <sub>IN</sub> = V <sub>DF</sub> × 0.9V, V <sub>OUT</sub> = 0V, Cd: Open		-0.20		μA	③
	N-ch Open Drain Output		V <sub>IN</sub> = 6.0V, V <sub>OUT</sub> = 6.0V, Cd: Open		0.20	0.40		
Temperature Characteristics		ΔV <sub>DF</sub> / (ΔTa · V <sub>DF</sub> )	-40 °C ≤ Ta ≤ 85 °C		± 100		ppm/°C	①
Delay Resistance <sup>(*)7</sup>		R <sub>DELAY</sub>	V <sub>IN</sub> =6.0V, Cd=0V	1.6	2.0	2.4	MΩ	⑤
Delay Pin Sink Current		I <sub>CD</sub>	Cd=0.5V, V <sub>IN</sub> =0.7V	8	60		μA	⑤
Delay Capacitance Pin Threshold Voltage		V <sub>TCD</sub>	V <sub>IN</sub> =1.0V	0.4	0.5	0.6	V	⑥
			V <sub>IN</sub> =6.0V	2.9	3.0	3.1		
Unspecified Operating Voltage <sup>(*)8</sup>		V <sub>UNS</sub>	V <sub>IN</sub> =0~0.7V		0.3	0.4	V	⑦
Detect Delay Time <sup>(*)9</sup>		t <sub>DF0</sub>	V <sub>IN</sub> =6.0→0.7V Cd: Open		30	230	μs	⑧
Detect Delay Time <sup>(*)9</sup>		t <sub>DR0</sub>	V <sub>IN</sub> =0.7V→6.0V Cd: Open		30	200	μs	⑧

**NOTE:**

(\*) V<sub>DF(T)</sub>: Setting Detect Voltage

(\*)2 V<sub>DF(T)</sub> > 1.0V

(\*)3 V<sub>DF(T)</sub> > 2.0V

(\*)4 V<sub>DF(T)</sub> > 3.0V

(\*)5 V<sub>DF(T)</sub> > 4.0V

(\*)6 This numerical value is applied only to the XC6119C series (CMOS output).

(\*)7 Calculated from the voltage value and the current value of both ends of the resistor.

(\*)8 The maximum voltage of the V<sub>OUT</sub> in the range of the V<sub>IN</sub> 0 to 0.7V. This numerical value is applied only to the XC6119C series (CMOS output).

(\*)9 Time which ranges from the state of V<sub>IN</sub> = V<sub>DF</sub> to the V<sub>OUT</sub> reaching 0.6V when the V<sub>IN</sub> falls without connecting to the Cd pin.

(\*)10 Time which ranges from the state of V<sub>IN</sub> = V<sub>DF</sub> + V<sub>HYS</sub> to the V<sub>OUT</sub> reaching 5.4V when the V<sub>IN</sub> rises without connecting to the Cd pin.

## VOLTAGE CHART

SYMBOL	E-1			E-2	
PARAMETER	DETECT VOLTAGE <sup>(*)</sup>			OUTPUT CURRENT <sup>(*)</sup>	
SETTING DETECT VOLTAGE	(V)			(mA)	
V <sub>DF(T)</sub>	V <sub>DF</sub>			I <sub>OUT2</sub>	
	MIN.	TYP.	MAX.	MIN.	TYP.
0.8	0.770	0.8	0.830	-0.40	-0.20
0.9	0.870	0.9	0.930		
1.0	0.970	1.0	1.030		
1.1	1.070	1.1	1.130	-0.60	-0.30
1.2	1.170	1.2	1.230		
1.3	1.270	1.3	1.330		
1.4	1.370	1.4	1.430		
1.5	1.470	1.5	1.530		
1.6	1.568	1.6	1.632	-0.80	-0.40
1.7	1.666	1.7	1.734		
1.8	1.764	1.8	1.836		
1.9	1.862	1.9	1.938		
2.0	1.960	2.0	2.040		
2.1	2.058	2.1	2.142	-1.00	-0.50
2.2	2.156	2.2	2.244		
2.3	2.254	2.3	2.346		
2.4	2.352	2.4	2.448		
2.5	2.450	2.5	2.550		
2.6	2.548	2.6	2.652		
2.7	2.646	2.7	2.754		
2.8	2.744	2.8	2.856		
2.9	2.842	2.9	2.958		
3.0	2.940	3.0	3.060		
3.1	3.038	3.1	3.162	-1.20	-0.60
3.2	3.136	3.2	3.264		
3.3	3.234	3.3	3.366		
3.4	3.332	3.4	3.468		
3.5	3.430	3.5	3.570		
3.6	3.528	3.6	3.672		
3.7	3.626	3.7	3.774		
3.8	3.724	3.8	3.876		
3.9	3.822	3.9	3.978		
4.0	3.920	4.0	4.080		
4.1	4.018	4.1	4.182	-1.30	-0.65
4.2	4.116	4.2	4.284		
4.3	4.214	4.3	4.386		
4.4	4.321	4.4	4.488		
4.5	4.410	4.5	4.590		
4.6	4.508	4.6	4.692		
4.7	4.606	4.7	4.794		
4.8	4.704	4.8	4.896		
4.9	4.802	4.9	4.998		
5.0	4.900	5.0	5.100		

**NOTE:**

<sup>(\*)</sup> When V<sub>DF(T)</sub> ≤ 1.4V, the detection accuracy is ±30mV. When V<sub>DF(T)</sub> ≥ 1.5V, the detection accuracy is ±2%.

<sup>(\*)</sup> This numerical value is applied only to the XC6119C series (CMOS output).

**TEST CIRCUITS**

Circuit ①



Circuit ②



Circuit ③



Circuit ④



Circuit ⑤



Circuit ⑥



Circuit ⑦



Circuit ⑧



## OPERATIONAL EXPLANATION

A typical circuit example is shown in Figure 1, and the timing chart of Figure 1 is shown in Figure 2 on the next page.



Figure 1: Typical application circuit example

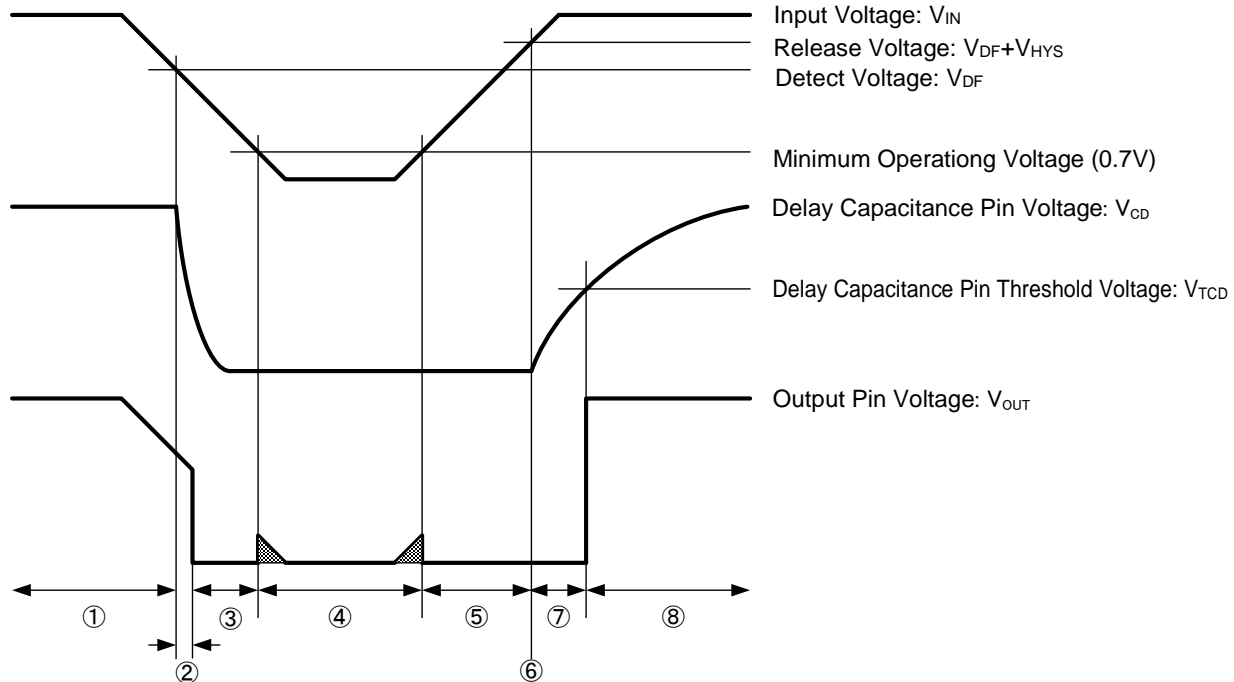

Figure 2: The timing chart of Figure 1

- ① As an early state, the input voltage pin is applied sufficiently high voltage to the release voltage and the delay capacitance ( $C_d$ ) is charged to the input pin voltage. While the input pin voltage ( $V_{IN}$ ) starts dropping to reach the detect voltage ( $V_{DF}$ ) ( $V_{IN} > V_{DF}$ ), the output voltage ( $V_{OUT}$ ) keeps the "High" level ( $=V_{IN}$ ).
- ② When the input pin voltage keeps dropping and becomes equal to the detect voltage ( $V_{IN} = V_{DF}$ ), an N-ch transistor for the delay capacitance discharge is turned ON, and starts to discharge the delay capacitance. For the internal circuit, which uses the delay capacitance pin as power input, the reference voltage operates as a comparator of  $V_{IN}$ , and the output voltage changes into the "Low" level ( $\leq V_{IN} \times 0.1$ ). The detect delay time ( $t_{DF}$ ) is defined as time which ranges from  $V_{IN} = V_{DF}$  to the  $V_{OUT}$  of "Low" level (especially, when the  $C_d$  pin is not connected:  $t_{DF0}$ ).
- ③ While the input pin voltage keeps below the detect voltage, and 0.7V or more, the delay capacitance is discharged to the ground voltage ( $=V_{SS}$ ) level. Then, the output voltage ( $V_{OUT}$ ) maintains the "Low" level.
- ④ While the input pin voltage drops to less than 0.7V and it increases again to 0.7V or more, the output voltage may not be able to maintain the "Low" level. Such an operation is called "Unspecified Operation", and voltage which occurs at the output pin voltage is defined as unstable operating voltage ( $V_{UNS}$ ).



## ■ OPERATIONAL EXPLANATION (Continued)

- ⑤ While the input pin voltage increases more than 0.7V and it reaches to the release voltage level ( $V_{IN} < V_{DF} + V_{HYS}$ ), the output voltage ( $V_{OUT}$ ) maintains the “Low” level.
- ⑥ When the input pin voltage continues to increase more than 0.7V up to the release voltage level ( $= V_{DF} + V_{HYS}$ ), the N-ch transistor for the delay capacitance discharge will be turned OFF, and the delay capacitance will be started discharging via a delay resistor ( $R_{DELAY}$ ). The internal circuit, which uses the delay capacitance pin as power input, will operate as a hysteresis comparator (Rise Logic Threshold:  $V_{TLH} = V_{TCD}$ , Fall Logic Threshold:  $V_{THL} = V_{SS}$ ) while the input pin voltage keeps higher than the detect voltage ( $V_{IN} > V_{DF}$ ).
- ⑦ While the input pin voltage becomes equal to the release voltage or higher and keeps the detect voltage or higher, the delay capacitance ( $C_d$ ) will be charged up to the input pin voltage. When the delay capacitance pin voltage ( $V_{CD}$ ) reaches to the delay capacitance pin threshold voltage ( $V_{TCD}$ ), the output voltage changes into the “High” ( $= V_{IN}$ ) level.  $t_{DR}$  is defined as time which ranges from  $V_{IN} = V_{DF} + V_{HYS}$  to the  $V_{OUT}$  of “High” level (especially when the  $C_d$  pin is not connected:  $t_{DR0}$ ).  $t_{DR}$  can be given by the formula (1).

$$t_{DR} = -R_{DELAY} \times C_d \times \ln(1 - V_{TCD} / V_{IN}) + t_{DR0} \dots(1)$$

\*  $\ln$  = a natural logarithm

The release delay time can also be briefly calculated with the formula (2) because the delay resistance is  $2.0M\Omega$  (TYP.) and the delay capacitance pin threshold voltage is  $V_{IN}/2$  (TYP.)

$$t_{DR} = R_{DELAY} \times C_d \times 0.69 \dots(2)$$

\*  $R_{DELAY}$  is  $2.0M\Omega$  (TYP.)

As an example, presuming that the delay capacitance is  $0.68\mu F$ ,  $t_{DR}$  is :

$$2.0 \times 10^6 \times 0.68 \times 10^{-6} \times 0.69 = 938(ms)$$

\* Note that the release delay time may remarkably be short when the delay capacitance is not discharged to the ground ( $= V_{SS}$ ) level because time described in ③ is short.

- ⑧ While the input pin voltage is higher than the detect voltage ( $V_{IN} > V_{DF}$ ), therefore, the output voltage maintains the “High” ( $= V_{IN}$ ) level.

### ● Release Delay Time Chart

Delay Capacitance [Cd] ( $\mu F$ )	Release Delay Time [tDR] (TYP.) (ms)	Release Delay Time [tDR] (MIN. ~ MAX.) *1 (ms)
0.01	13.8	11.0 ~ 16.6
0.022	30.4	24.3 ~ 36.4
0.047	64.9	51.9 ~ 77.8
0.1	138	110 ~ 166
0.22	304	243 ~ 364
0.47	649	519 ~ 778
1	1380	1100 ~ 1660

\* The release delay time values above are calculate by using formula (2).

(<sup>1</sup>)The release delay time ( $t_{DR}$ ) is influenced by the release capacitance (Cd).

## NOTES ON USE

1. Please use this IC within the stated maximum ratings. For temporary, transitional voltage drop or voltage rising phenomenon, the IC is liable to malfunction should the ratings be exceeded.
2. The input pin voltage drops by the resistance between power supply and the  $V_{IN}$  pin, and by through current at operation of the IC. At this time, the operation may be wrong if the input pin voltage falls below the minimum operating voltage range. In CMOS output, for output current, drops in the input pin voltage similarly occur. Oscillation of the circuit may occur if the drops in voltage, which caused by through current at operation of the IC, exceed the hysteresis voltage. Note it especially when you use the IC with the  $V_{IN}$  pin connected to a resistor.
3. Note that a rapid and high fluctuation of the input pin voltage may cause a wrong operation.
4. Power supply noise may cause an operational function error. Care must be taken to put an external capacitor between  $V_{IN}$ -GND and test on the board carefully.
5. When there is a possibility of which the input pin voltage falls rapidly (e.g.: 6.0V to 0V) at release operation with the delay capacitance pin (Cd) connected to a capacitor, use a schottky barrier diode connected between the  $V_{IN}$  pin and the Cd pin as the Figure 3 shown below.
6. When N-channel open drain output is used, output voltages  $V_{OUT}$  at voltage detection and release are determined by a pull-up resistor tied to the output pin. A resistance value of the pull-up resistor can be selected with referring to the followings. (Refer to Figure 4)

During detection, the formula is given as

$$V_{OUT} = V_{PULL} / (1 + R_{PULL} / R_{ON})$$

where  $V_{PULL}$  is pull-up voltage and  $R_{ON}$  (\*1) is ON resistance of N-channel driver M5 ( $R_{ON} = V_{DS} / I_{OUT1}$  from the electrical characteristics table).

For example, when  $V_{IN} = 2.0V$  (\*2),  $R_{ON} = 0.5 / 0.8 \times 10^{-3} = 625 \Omega$  (MIN.) and if you want to get  $V_{OUT}$  less than 0.1V when  $V_{PULL} = 3.0V$ ,  $R_{PULL}$  can be calculated as follows;

$$R_{PULL} = (V_{PULL} / V_{OUT} - 1) \times R_{ON} = (3 / 0.1 - 1) \times 625 \approx 18 \text{ k} \Omega$$

Therefore, pull-up resistance should be selected 18k $\Omega$  or higher.

(\*1)  $V_{IN}$  is smaller,  $R_{ON}$  is bigger

(\*2) For the calculation, the lowest  $V_{IN}$  should be used among of the  $V_{IN}$  range

During release, the formula is given as

$$V_{OUT} = V_{PULL} / (1 + R_{PULL} / R_{OFF})$$

where  $V_{PULL}$  is pull-up voltage  $R_{OFF}$  is OFF resistance of N-channel driver M5 ( $R_{OFF} = V_{OUT} / I_{LEAK} = 15M\Omega$  from the electrical characteristics table)

For examples, if you want to get  $V_{OUT}$  larger than 5.99V when  $V_{PULL}$  is 6.0V,  $R_{PULL}$  can be calculated as follows;

$$R_{PULL} = (V_{PULL} / V_{OUT} - 1) \times R_{OFF} = (6 / 5.99 - 1) \times 15 \times 10^6 \approx 25 \text{ k} \Omega$$

Therefore, pull-up resistance should be selected 25k $\Omega$  or below.

7. Torex places an importance on improving our products and their reliability. We request that users incorporate fail-safe designs and post-aging protection treatment when using Torex products in their systems.



Figure 3: Circuit example with the delay capacitance pin (Cd) connected to a schottky barrier diode



Note:  $R_{OFF} = V_{OUT} / I_{LEAK}$   
Figure 4: Circuit example of XC6109N Series

## ■ TYPICAL PERFORMANCE CHARACTERISTICS

(1) Supply Current vs. Input Voltage



(2) Detect Voltage vs. Ambient Temperature

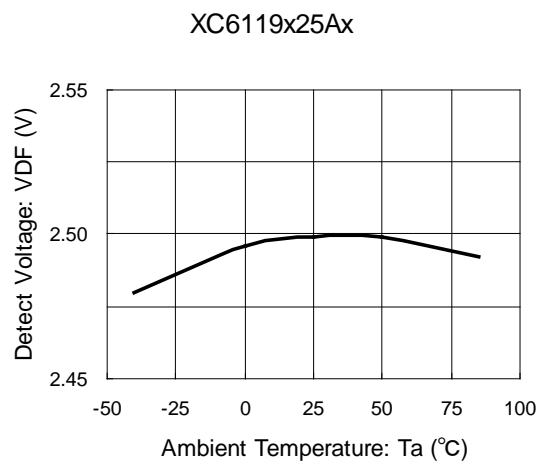

(3) Hysteresis Voltage vs. Ambient Temperature



(4) Output Voltage vs. Input Voltage



## TYPICAL PERFORMANCE CHARACTERISTICS (Continued)

(5) Output Current vs. Input Voltage



(6) Cd Pin Sink Current vs. Input Voltage



(7) Delay Resistance vs. Ambient Temperature

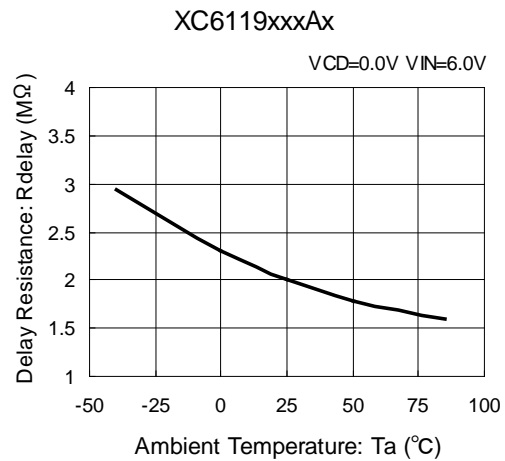

(8) Release Delay Time vs. Delay Capacitance



(9) Detect Delay Time vs. Delay Capacitance



## ■ TYPICAL PERFORMANCE CHARACTERISTICS (Continued)

(10) Leak Current vs. Ambient Temperature



(11) Leak Current vs. Supply Voltage



## ■ PACKAGING INFORMATION

For the latest package information go to, [www.torexsemi.com/technical-support/packages](http://www.torexsemi.com/technical-support/packages)

PACKAGE	OUTLINE / LAND PATTERN	THERMAL CHARACTERISTICS	
SSOT-24	<a href="#">SSOT-24 PKG</a>	Standard Board	<a href="#">SSOT-24 Power Dissipation</a>
USPN-4	<a href="#">USPN-4 PKG</a>	Standard Board	<a href="#">USPN-4 Power Dissipation</a>

## MARKING RULE

### ●SSOT-24

① represents output configuration and integer number of detect voltage

#### CMOS Output (XC6119C Series)

MARK	VOLTAGE (V)	PRODUCT SERIES
A	0.X	XC6119C0**N*
B	1.X	XC6119C1**N*
C	2.X	XC6119C2**N*
D	3.X	XC6119C3**N*
E	4.X	XC6119C4**N*
F	5.X	XC6119C5**N*

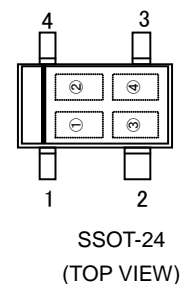

#### N-channel Open Drain Output (XC6119N Series)

MARK	VOLTAGE (V)	PRODUCT SERIES
H	0.X	XC6119N0**N*
K	1.X	XC6119N1**N*
L	2.X	XC6119N2**N*
M	3.X	XC6119N3**N*
N	4.X	XC6119N4**N*
P	5.X	XC6119N5**N*

② represents decimal number of detect voltage

MARK	VOLTAGE (V)	PRODUCT SERIES
N	X.0	XC6119**0*N*
P	X.1	XC6119**1*N*
R	X.2	XC6119**2*N*
S	X.3	XC6119**3*N*
T	X.4	XC6119**4*N*
U	X.5	XC6119**5*N*
V	X.6	XC6119**6*N*
X	X.7	XC6119**7*N*
Y	X.8	XC6119**8*N*
Z	X.9	XC6119**9*N*

③④ represents production lot number

01 to 09, 0A to 0Z, 11 to 9Z, A1 to A9, AA to Z9, ZA to ZZ repeated (G, I, J, O, Q, W excluded).

Note: No character inversion used.

## MARKING RULE (Continued)

### ●USPN-4

① represents product series.

MARK	PRODUCT SERIES
B	XC6119*****-G

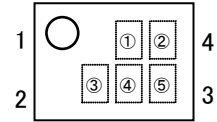

USPN-4  
(TOP VIEW)

② represents output configuration and integer number of detect voltage

#### CMOS Output (XC6119C Series)

MARK	VOLTAGE (V)	PRODUCT SERIES
A	0.X	XC6119C0**7*-G
B	1.X	XC6119C1**7*-G
C	2.X	XC6119C2**7*-G
D	3.X	XC6119C3**7*-G
E	4.X	XC6119C4**7*-G
F	5.X	XC6119C5**7*-G

#### N-channel Open Drain Output (XC6119N Series)

MARK	VOLTAGE (V)	PRODUCT SERIES
H	0.X	XC6119N0**7*-G
K	1.X	XC6119N1**7*-G
L	2.X	XC6119N2**7*-G
M	3.X	XC6119N3**7*-G
N	4.X	XC6119N4**7*-G
P	5.X	XC6119N5**7*-G

③ represents decimal number of detect voltage

MARK	VOLTAGE (V)	PRODUCT SERIES
N	X.0	XC6119**0*7*-G
P	X.1	XC6119**1*7*-G
R	X.2	XC6119**2*7*-G
S	X.3	XC6119**3*7*-G
T	X.4	XC6119**4*7*-G
U	X.5	XC6119**5*7*-G
V	X.6	XC6119**6*7*-G
X	X.7	XC6119**7*7*-G
Y	X.8	XC6119**8*7*-G
Z	X.9	XC6119**9*7*-G

④⑤ represents production lot number

01 to 09, 0A to 0Z, 11 to 9Z, A1 to A9, AA to Z9, ZA to ZZ repeated (G, I, J, O, Q, W excluded).

Note: No character inversion used.





1. The product and product specifications contained herein are subject to change without notice to improve performance characteristics. Consult us, or our representatives before use, to confirm that the information in this datasheet is up to date.
2. The information in this datasheet is intended to illustrate the operation and characteristics of our products. We neither make warranties or representations with respect to the accuracy or completeness of the information contained in this datasheet nor grant any license to any intellectual property rights of ours or any third party concerning with the information in this datasheet.
3. Applicable export control laws and regulations should be complied and the procedures required by such laws and regulations should also be followed, when the product or any information contained in this datasheet is exported.
4. The product is neither intended nor warranted for use in equipment of systems which require extremely high levels of quality and/or reliability and/or a malfunction or failure which may cause loss of human life, bodily injury, serious property damage including but not limited to devices or equipment used in 1) nuclear facilities, 2) aerospace industry, 3) medical facilities, 4) automobile industry and other transportation industry and 5) safety devices and safety equipment to control combustions and explosions. Do not use the product for the above use unless agreed by us in writing in advance.
5. Although we make continuous efforts to improve the quality and reliability of our products; nevertheless Semiconductors are likely to fail with a certain probability. So in order to prevent personal injury and/or property damage resulting from such failure, customers are required to incorporate adequate safety measures in their designs, such as system fail safes, redundancy and fire prevention features.
6. Our products are not designed to be Radiation-resistant.
7. Please use the product listed in this datasheet within the specified ranges.
8. We assume no responsibility for damage or loss due to abnormal use.
9. All rights reserved. No part of this datasheet may be copied or reproduced unless agreed by Torex Semiconductor Ltd in writing in advance.

TOREX SEMICONDUCTOR LTD.

Компания «Океан Электроники» предлагает заключение долгосрочных отношений при поставках импортных электронных компонентов на взаимовыгодных условиях!

Наши преимущества:

- Поставка оригинальных импортных электронных компонентов напрямую с производств Америки, Европы и Азии, а так же с крупнейших складов мира;
- Широкая линейка поставок активных и пассивных импортных электронных компонентов (более 30 млн. наименований);
- Поставка сложных, дефицитных, либо снятых с производства позиций;
- Оперативные сроки поставки под заказ (от 5 рабочих дней);
- Экспресс доставка в любую точку России;
- Помощь Конструкторского Отдела и консультации квалифицированных инженеров;
- Техническая поддержка проекта, помощь в подборе аналогов, поставка прототипов;
- Поставка электронных компонентов под контролем ВП;
- Система менеджмента качества сертифицирована по Международному стандарту ISO 9001;
- При необходимости вся продукция военного и аэрокосмического назначения проходит испытания и сертификацию в лаборатории (по согласованию с заказчиком);
- Поставка специализированных компонентов военного и аэрокосмического уровня качества (Xilinx, Altera, Analog Devices, Intersil, Interpoint, Microsemi, Actel, Aeroflex, Peregrine, VPT, Syfer, Eurofarad, Texas Instruments, MS Kennedy, Miteq, Cobham, E2V, MA-COM, Hittite, Mini-Circuits, General Dynamics и др.);

Компания «Океан Электроники» является официальным дистрибьютором и эксклюзивным представителем в России одного из крупнейших производителей разъемов военного и аэрокосмического назначения «JONHON», а так же официальным дистрибьютором и эксклюзивным представителем в России производителя высокотехнологичных и надежных решений для передачи СВЧ сигналов «FORSTAR».



## JONHON

«JONHON» (основан в 1970 г.)

Разъемы специального, военного и аэрокосмического назначения:

(Применяются в военной, авиационной, аэрокосмической, морской, железнодорожной, горно- и нефтедобывающей отраслях промышленности)

«FORSTAR» (основан в 1998 г.)

ВЧ соединители, коаксиальные кабели, кабельные сборки и микроволновые компоненты:

(Применяются в телекоммуникациях гражданского и специального назначения, в средствах связи, РЛС, а так же военной, авиационной и аэрокосмической отраслях промышленности).



Телефон: 8 (812) 309-75-97 (многоканальный)

Факс: 8 (812) 320-03-32

Электронная почта: [ocean@oceanchips.ru](mailto:ocean@oceanchips.ru)

Web: <http://oceanchips.ru/>

Адрес: 198099, г. Санкт-Петербург, ул. Калинина, д. 2, корп. 4, лит. А