

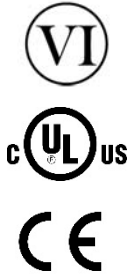

300W Desktop C14 Adapter Series



Features

- DOE Level VI Efficiency Compliant
- Over Voltage, Short Circuit and Over Current Protection
- Non-Vented/Spill-Proof Case
- Class B EMI

Applications

- Networking
- Peripherals
- Consumer Electronics



PPL300U Series Specifications¹

Model		PPL300U-120	PPL300U-190	PPL300U-240	PPL300U-480
Output	DC Output Voltage	12.0V	19.0V	24.0V	48.0V
	Max Current	24.0A	15.75A	12.5A	6.25A
	Output Power	288.0W	299.25W	300.0W	300.0W
	Regulation	± 5%	± 5%	± 5%	± 5%
	Ripple & Noise P-P(max) ²	240mV	380mV	480mV	960mV
Input	AC Input Voltage Range	90 to 264VAC			
	AC Input Frequency	47 to 63Hz			
	Input Current	3.9A max			
	Inrush Current	150A max., 230VAC (cold start at ambient 25°C, full load)			
	No Load Power Consumption at 115VAC Input	≤ 0.5W			
	No Load Power Consumption at 230VAC Input	≤ 0.5W			
	115VAC Average Efficiency ³	≥ 87.5%			
	230VAC Average Efficiency ³	≥ 87.5%			
	Leakage Current	<3.5mA			
Protection	Over-Voltage	150% max	150% max	150% max	150% max
	Short Circuit	Latch			
	Over-Temperature	Latch			
	Over-Current	150% max	150% max	150% max	150% max
Environmental	Operating Temperature	0°C to +40°C			
	Non-Operating Temperature	-20° to +80°C			
	Operating Humidity	20 to +80%			
Safety Approvals and EMC	Dielectric Withstand (HI-POT)	Primary to Secondary: 3000VAC for 1min, 10mA			
	Insulation Resistance	Primary to Secondary: 10M ohm for 500VDC			
	Standards	cULus 62368-1, IEC 62368-1			
	EMI Emissions	FCC Part 15 Class B, CAN ICES-003(B)/NMB-003(B), EN 55032/CISPR 32 Class B Conducted and Radiated			
	Harmonic Current Emissions	IEC 61000-3-2			
	Voltage Fluctuations & Flicker	IEC 61000-3-3			
	Immunity	EN 55024/CISPR 24: IEC 61000-4-2, IEC 61000-4-3, IEC 61000-4-4, IEC 61000-4-5, IEC 61000-4-6, IEC 61000-4-8, IEC 61000-4-11			
Mechanical	Dimensions (L x W x H)	254mm (10.0in) x 116mm (4.57in) x 47mm (1.85in)			
	Weight	1600g			
	Cable Length	1000mm	1200mm	1200mm	1200mm
	DC Cable Type	16AWG*6C	16AWG*4C	16AWG*4C	16AWG*4C
	DC Output Connector	6-Position Molex housing 39-01-2060 with terminals 39-00-077 Mates with Molex housing 39-01-2061 with terminals 39-00-0081			
	DC Plug Pin Assignment	12V: P1(+); P2(+); P3(+); P4(-); P5(-); P6(+) 19V, 24V, 48V, 56V: P1(+); P3(+); P4(-); P6(-)			
	Input Connector	IEC 60320 C14			

Model		PPL300U-560L6
Output	DC Output Voltage	56.0V
	Max Current	5.36A
	Output Power	300.2W
	Regulation	± 5%
	Ripple & Noise P-P(max) ²	1000mV
Input	AC Input Voltage Range	90 to 264VAC
	AC Input Frequency	47 to 63Hz
	Input Current	3.9A max
	Inrush Current	150A max., 230VAC (Cold start at ambient 25°C, full load)
	No Load Power Consumption at 115VAC Input	≤ 0.5W
	No Load Power Consumption at 230VAC Input	≤ 0.5W
	115VAC Average Efficiency ³	≥ 87.5%
	230VAC Average Efficiency ³	≥ 87.5%
	Leakage Current	<3.5mA
Protection	Over-Voltage	150% max
	Short Circuit	Latch
	Over-Temperature	Latch
	Over-Current	150% max
Environmental	Operating Temperature	0°C to +40°C
	Non-Operating Temperature	-20° to +80°C
	Operating Humidity	20 to +80%
Safety Approvals and EMC	Dielectric Withstand (HI-POT)	Primary to Secondary: 3000VAC for 1min, 10mA
	Insulation Resistance	Primary to Secondary: 10M ohm for 500VDC
	Standards	cULus 62368-1, IEC 62368-1
	EMI Emissions	FCC Part 15 Class B, CAN ICES-003(B)/NMB-003(B), EN 55032/CISPR 32 Class B Conducted and Radiated
	Harmonic Current Emissions	IEC 61000-3-2
	Voltage Fluctuations & Flicker	IEC 61000-3-3
	Immunity	EN 55024/CISPR 24: IEC 61000-4-2, IEC 61000-4-3, IEC 61000-4-4, IEC 61000-4-5, IEC 61000-4-6, IEC 61000-4-8, IEC 61000-4-11
Mechanical	Dimensions (L x W x H)	254mm (10.0in) x 116mm (4.57in) x 47mm (1.85in)
	Weight	1600g
	Cable Length	1200mm
	DC Cable Type	16AWG*4C
	DC Output Connector	6-Position Molex housing 39-01-2060 with terminals 39-00-077 Mates with Molex housing 39-01-2061 with terminals 39-00-0081
	DC Plug Pin Assignment	12V: P1(+); P2(+); P3(+); P4(-); P5(-); P6(+) 19V, 24V, 48V, 56V: P1(+); P3(+); P4(-); P6(-)
	Input Connector	IEC 60320 C14
Notes	<ol style="list-style-type: none"> The specifications defined are at ambient temperature of 25°C, unless otherwise specified. 20MHz bandwidth frequency oscilloscope, add a 0.1µF multilayer Cap. and Low ESR Electrolytic Cap. (10µF) at output connector terminals (nominal line voltage, full load). Efficiency is measured after 30 minutes burn-in. 	



PPL300U Outline Drawing

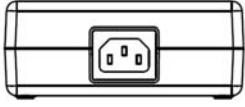
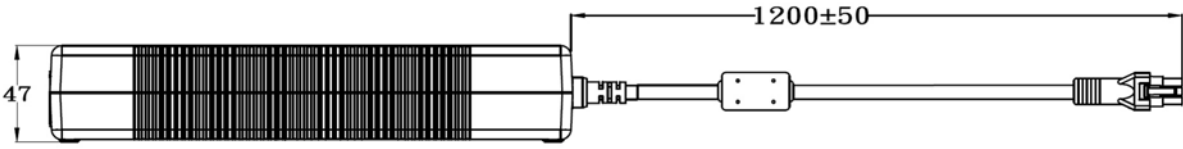
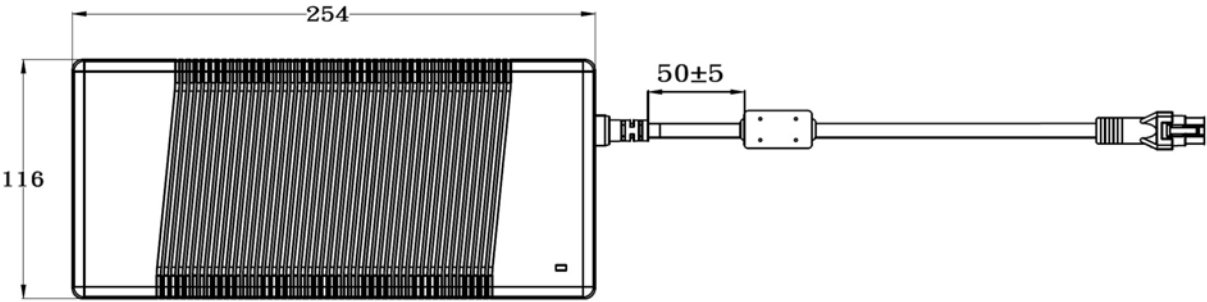

FRONT-VIEW

**Supplier's Declaration of Conformity
47 CFR § 2.1077 Compliance Information**

**PPL300U-120
PPL300U-190
PPL300U-240
PPL300U-480
PPL300U-560**

Phihong USA Corporation
47800 Fremont Boulevard
Fremont, CA 94538
Telephone: (510) 445-0100
www.phihong.com



NOTE: This model has/The models in this product series have been tested and found to comply with the limits for a Class B digital device, pursuant to part 15 of the FCC Rules. These limits are designed to provide reasonable protection against harmful interference in a residential installation. This equipment generates, uses and can radiate radio frequency energy and, if not installed and used in accordance with the instructions, may cause harmful interference to radio communications. However, there is no guarantee that interference will not occur in a particular installation. If this equipment does cause harmful interference to radio or television reception, which can be determined by turning the equipment off and on, the user is encouraged to try to correct the interference by one or more of the following measures:

- Reorient or relocate the receiving antenna.
- Increase the separation between the equipment and receiver.
- Connect the equipment into an outlet on a circuit different from that to which the receiver is connected.
- Consult the dealer or an experienced radio/TV technician for help.

Changes or modifications to equipment not expressly approved by PHIHONG could void the user's authority to operate the equipment.



PPL300U Line Cords Sold Separately

Model		AC30UNA-R	AC30UEU-R	AC30UUK-R
Specifications	Plug Type	North America NEMA 5-15P	Continental Europe CEE 7VIII	United Kingdom BS 1363
	Connector	IEC320 C13	IEC320 C13	IEC320 C13
	Wire Size	18 AWG	0.75mm	1.0mm
	Temperature	60°C	70°C	70 °C
	Amperage Rating	10A	6A	10A
	Voltage Rating	125V	250V	250V
	Cable Length	1830mm	1830mm	2500mm
Safety Approvals		CSA; UL	CEBEC; DEMKO; DVE; FIMKO; GOST; IMQ; KEMA; NEMKO; NF; OVE; SEMKO	BSI; Safety Mark
Photos				



PPL300U Line Cords Outline Drawings

AC30UNA-R

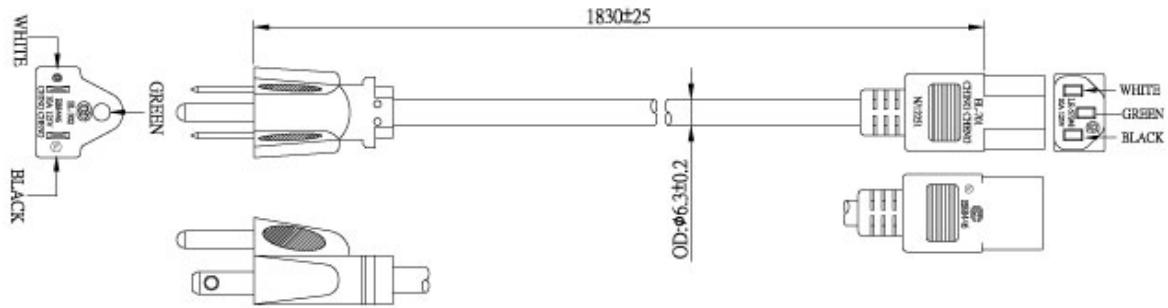

AC30UEU-R

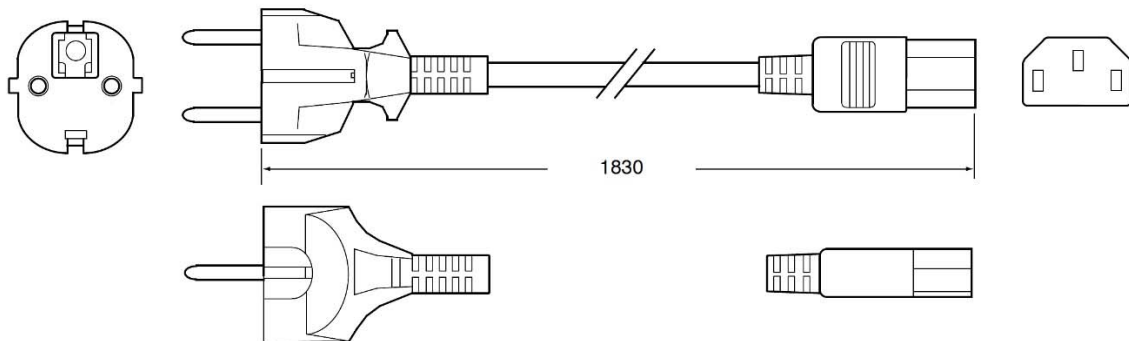

AC30UUK-R

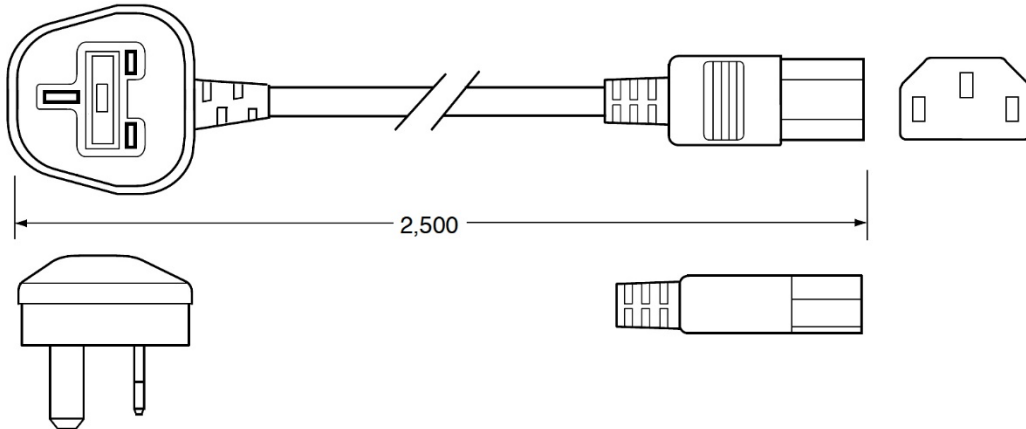

Компания «Океан Электроники» предлагает заключение долгосрочных отношений при поставках импортных электронных компонентов на взаимовыгодных условиях!

Наши преимущества:

- Поставка оригинальных импортных электронных компонентов напрямую с производств Америки, Европы и Азии, а так же с крупнейших складов мира;
- Широкая линейка поставок активных и пассивных импортных электронных компонентов (более 30 млн. наименований);
- Поставка сложных, дефицитных, либо снятых с производства позиций;
- Оперативные сроки поставки под заказ (от 5 рабочих дней);
- Экспресс доставка в любую точку России;
- Помощь Конструкторского Отдела и консультации квалифицированных инженеров;
- Техническая поддержка проекта, помощь в подборе аналогов, поставка прототипов;
- Поставка электронных компонентов под контролем ВП;
- Система менеджмента качества сертифицирована по Международному стандарту ISO 9001;
- При необходимости вся продукция военного и аэрокосмического назначения проходит испытания и сертификацию в лаборатории (по согласованию с заказчиком);
- Поставка специализированных компонентов военного и аэрокосмического уровня качества (Xilinx, Altera, Analog Devices, Intersil, Interpoint, Microsemi, Actel, Aeroflex, Peregrine, VPT, Syfer, Eurofarad, Texas Instruments, MS Kennedy, Miteq, Cobham, E2V, MA-COM, Hittite, Mini-Circuits, General Dynamics и др.);

Компания «Океан Электроники» является официальным дистрибьютором и эксклюзивным представителем в России одного из крупнейших производителей разъемов военного и аэрокосмического назначения «JONHON», а так же официальным дистрибьютором и эксклюзивным представителем в России производителя высокотехнологичных и надежных решений для передачи СВЧ сигналов «FORSTAR».



JONHON

«JONHON» (основан в 1970 г.)

Разъемы специального, военного и аэрокосмического назначения:

(Применяются в военной, авиационной, аэрокосмической, морской, железнодорожной, горно- и нефтедобывающей отраслях промышленности)

«FORSTAR» (основан в 1998 г.)

ВЧ соединители, коаксиальные кабели, кабельные сборки и микроволновые компоненты:

(Применяются в телекоммуникациях гражданского и специального назначения, в средствах связи, РЛС, а так же военной, авиационной и аэрокосмической отраслях промышленности).



Телефон: 8 (812) 309-75-97 (многоканальный)

Факс: 8 (812) 320-03-32

Электронная почта: ocean@oceanchips.ru

Web: <http://oceanchips.ru/>

Адрес: 198099, г. Санкт-Петербург, ул. Калинина, д. 2, корп. 4, лит. А