

Cree® XLamp® XR-C LEDs



PRODUCT DESCRIPTION

The XLamp XR-C LED gives lighting designers the flexibility and performance to create the next generation of LED lighting products. XLamp XR-C LEDs feature electrically neutral thermal path, low thermal resistance and support for a wide range of drive currents.

Cree XLamp LEDs bring high performance and quality of light to a wide range of lighting applications, including color-changing, portable and personal, outdoor, indoor-directional, transportation, stage and studio, commercial and emergency-vehicle lighting.

FEATURES

- Available in white (2600 K to 10,000 K CCT), royal blue, blue, green, amber, red-orange & red
- Maximum drive current: up to 700 mA
- Low thermal resistance: as low as 12 °C/W
- Max junction temperature: 150 °C
- Industry-leading JEDEC standard pre-qualification testing
- Reflow solderable – JEDEC J-STD-020C compatible
- Electrically neutral thermal path
- Lumen maintenance of greater than 70% after 50,000 hours
- RoHS-compliant
- UL-recognized component (E326295)

TABLE OF CONTENTS

| | |
|--|----|
| Flux Characteristics - White | 2 |
| Flux Characteristics - Color | 2 |
| Characteristics - White, Royal Blue, Blue, Green | 4 |
| Characteristics - Amber, Red-Orange, Red | 4 |
| Relative Spectral Power Distribution . | 5 |
| Relative Flux vs. Junction Temperature | 6 |
| Electrical Characteristics | 7 |
| Thermal Design | 8 |
| Relative Flux vs. Current | 9 |
| Typical Spatial Distribution | 10 |
| Reflow Soldering Characteristics | 11 |
| Notes | 12 |
| Mechanical Dimensions | 14 |
| Tape and Reel | 15 |
| Dry Packaging and Packaging | 16 |



FLUX CHARACTERISTICS (T_j = 25 °C) - WHITE

The following tables describe the available colors and flux for XR-C LEDs by listing the correlated color temperature range for the entire family and by providing several base order codes. It is important to note that the base order codes listed here are a subset of the total available order codes for the product family. For more order codes, as well as a complete description of the order-code nomenclature, please consult the XR-E & XR-C Binning and Labeling document.

| Color | CCT Range | | Base Order Codes Min Luminous Flux (lm) | | Order Code |
|---------------|-----------|----------|---|-----------|----------------------|
| | Min. | Max. | Group | Flux (lm) | |
| Cool White | 5,000 K | 10,000 K | N3 | 56.8 | XRCWHT-L1-0000-00501 |
| | | | N4 | 62.0 | XRCWHT-L1-0000-00601 |
| | | | P2 | 67.2 | XRCWHT-L1-0000-00701 |
| | | | P3 | 73.9 | XRCWHT-L1-0000-00801 |
| | | | P4 | 80.6 | XRCWHT-L1-0000-00901 |
| | | | Q2 | 87.4 | XRCWHT-L1-0000-00A01 |
| Neutral White | 3,700 K | 5,000 K | N3 | 56.8 | XRCWHT-L1-0000-005E4 |
| | | | N4 | 62.0 | XRCWHT-L1-0000-006E4 |
| | | | P2 | 67.2 | XRCWHT-L1-0000-007E4 |
| | | | P3 | 73.9 | XRCWHT-L1-0000-008E4 |
| | | | P4 | 80.6 | XRCWHT-L1-0000-009E4 |
| Warm White | 2,600 K | 3,700 K | M3 | 45.7 | XRCWHT-L1-0000-003E7 |
| | | | N2 | 51.7 | XRCWHT-L1-0000-004E7 |
| | | | N3 | 56.8 | XRCWHT-L1-0000-005E7 |
| | | | N4 | 62.0 | XRCWHT-L1-0000-006E7 |
| | | | P2 | 67.2 | XRCWHT-L1-0000-007E7 |

Notes:

- Cree maintains a tolerance of $\pm 7\%$ on flux and power measurements, ± 0.005 on chromaticity (CC_x, CC_y) measurements and ± 2 on CRI measurements.
- Typical CRI for Cool White & Neutral White (3,700 K – 10,000 K CCT) is 75.
- Typical CRI for Warm White (2,600 K – 3,700 K CCT) is 80.

FLUX CHARACTERISTICS (T_j = 25 °C) - COLOR

| Color | Dominant Wavelength Range | | | | Base Order Codes Min. Radiant Flux (mW) | | Order Code |
|------------|---------------------------|-------------|-------|-------------|---|--------------|----------------------|
| | Min. | | Max. | | Group | Flux (mW) | |
| | Group | DWL (nm) | Group | DWL (nm) | | | |
| Royal Blue | D3 | 450 | D5 | 465 | 12 | 250 | XRCROY-L1-0000-00701 |
| | | | | | 13 | 300 | XRCROY-L1-0000-00801 |

FLUX CHARACTERISTICS (T_j = 25 °C) - COLOR (CONTINUED)

| Color | Dominant Wavelength Range | | | | Base Order Codes Min. Luminous Flux (lm) | | Order Code |
|-------|---------------------------|-------------|-------|-------------|--|--------------|----------------------|
| | Min. | | Max. | | Group | Flux (lm) | |
| | Group | DWL (nm) | Group | DWL (nm) | | | |
| Blue | B3 | 465 | B4 | 475 | G | 13.9 | XRCBLU-L1-0000-00G01 |
| | | | | | H | 18.1 | XRCBLU-L1-0000-00H01 |

| Color | Dominant Wavelength Range | | | | Base Order Codes Min. Luminous Flux (lm) | | Order Code |
|-------|---------------------------|-------------|-------|-------------|--|--------------|----------------------|
| | Min. | | Max. | | Group | Flux (lm) | |
| | Group | DWL (nm) | Group | DWL (nm) | | | |
| Green | G2 | 520 | G4 | 535 | M | 39.8 | XRCGRN-L1-0000-00M01 |
| | | | | | N | 51.7 | XRCGRN-L1-0000-00N01 |

| Color | Dominant Wavelength Range | | | | Base Order Codes Min. Luminous Flux (lm) | | Order Code |
|-------|---------------------------|-------------|-------|-------------|--|--------------|----------------------|
| | Min. | | Max. | | Group | Flux (lm) | |
| | Group | DWL (nm) | Group | DWL (nm) | | | |
| Amber | A2 | 585 | A3 | 595 | J | 23.5 | XRCAMB-L1-0000-00J01 |
| | | | | | K2 | 30.6 | XRCAMB-L1-0000-00K01 |
| | | | | | M2 | 39.8 | XRCAMB-L1-0000-00M01 |

| Color | Dominant Wavelength Range | | | | Base Order Codes Min. Luminous Flux (lm) | | Order Code |
|------------|---------------------------|-------------|-------|-------------|--|--------------|----------------------|
| | Min. | | Max. | | Group | Flux (lm) | |
| | Group | DWL (nm) | Group | DWL (nm) | | | |
| Red-Orange | O3 | 610 | O4 | 620 | K2 | 30.6 | XRCRDO-L1-0000-00K01 |
| | | | | | M2 | 39.8 | XRCRDO-L1-0000-00M01 |

| Color | Dominant Wavelength Range | | | | Base Order Codes Min. Luminous Flux (lm) | | Order Code |
|-------|---------------------------|-------------|-------|-------------|--|--------------|----------------------|
| | Min. | | Max. | | Group | Flux (lm) | |
| | Group | DWL (nm) | Group | DWL (nm) | | | |
| Red | R2 | 620 | R3 | 630 | J | 23.5 | XRCRED-L1-0000-00J01 |
| | | | | | K2 | 30.6 | XRCRED-L1-0000-00K01 |
| | | | | | M2 | 39.8 | XRCRED-L1-0000-00M01 |

Note: Cree maintains a tolerance of ±7% on flux and power measurements, ±0.005 on chromaticity (CC_x, CC_y) measurements and ±2 on CRI measurements.

CHARACTERISTICS - WHITE, ROYAL BLUE, BLUE, GREEN

| Characteristics | Unit | Minimum | Typical | Maximum |
|--|---------|---------|---------|---------|
| Thermal resistance, junction to solder point | °C/W | | 12 | |
| Viewing angle (FWHM) - white | degrees | | 90 | |
| Viewing angle (FWHM) - royal blue, blue, green | degrees | | 100 | |
| Temperature coefficient of voltage | mV/°C | | -4.0 | |
| ESD classification (HBM per Mil-Std-883D) | | | Class 2 | |
| DC forward current | mA | | | 500 |
| Reverse voltage | V | | | 5 |
| Forward voltage (@ 350 mA) - white, royal blue, blue | V | | 3.5 | 4.0 |
| Forward voltage (@ 350 mA) - green | V | | 3.7 | 4.0 |
| Forward voltage (@ 500 mA) - white, royal blue, blue | V | | 3.6 | |
| LED junction temperature* | °C | | | 150 |

*** Note: For lumen maintenance data, see the Cree XLamp LED Reliability document.**

CHARACTERISTICS - AMBER, RED-ORANGE, RED

| Characteristics | Unit | Minimum | Typical | Maximum |
|--|---------|---------|---------|---------|
| Thermal resistance, junction to solder point | °C/W | | 15 | |
| Viewing angle (FWHM) | degrees | | 90 | |
| Temperature coefficient of voltage - red-orange, red | mV/°C | | -2.3 | |
| Temperature coefficient of voltage - amber | mV/°C | | -1.8 | |
| ESD classification (HBM per Mil-Std-883D) | | | Class 2 | |
| DC forward current - red-orange, red | mA | | | 700 |
| DC forward current - amber | mA | | | 350 |
| Reverse voltage | V | | | 5 |
| Forward voltage (@ 350 mA) | V | | 2.2 | 2.5 |
| Forward voltage (@ 700 mA) - red-orange, red | V | | 2.4 | |
| LED junction temperature* | °C | | | 150 |

*** Note: For lumen maintenance data, see the Cree XLamp LED Reliability document.**

RELATIVE SPECTRAL POWER DISTRIBUTION



- 5000K - 10000K CCT
- 3700K - 5000K CCT
- 2600K - 3700K CCT



- Royal Blue
- Blue
- Green
- Amber
- Red-Orange
- Red

RELATIVE FLUX VS. JUNCTION TEMPERATURE ($I_f = 350 \text{ mA}$)

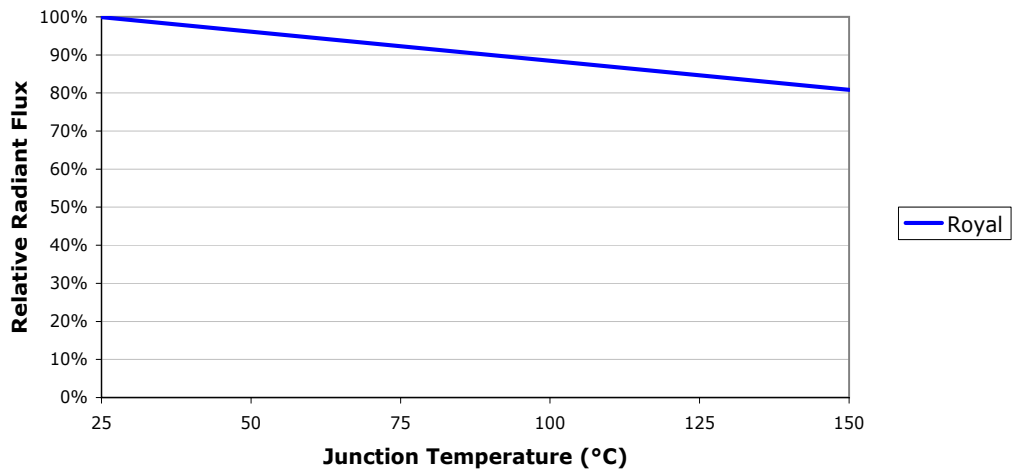

ELECTRICAL CHARACTERISTICS ($T_j = 25\text{ }^\circ\text{C}$)

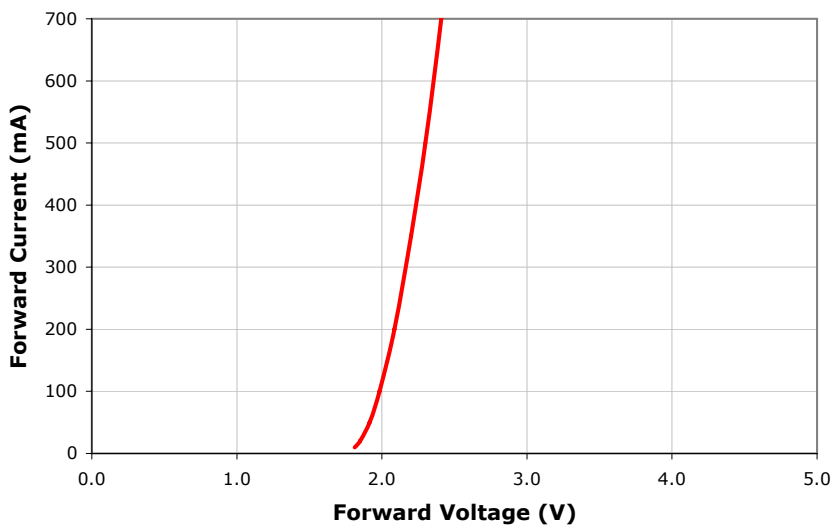
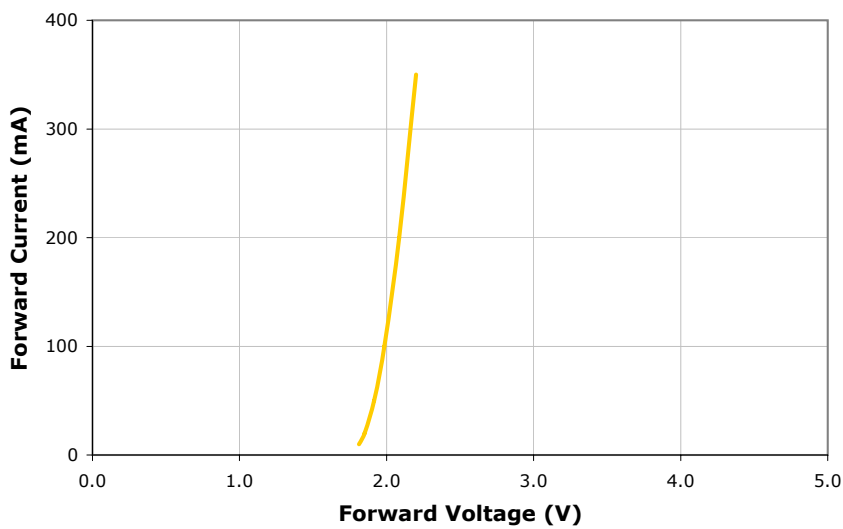
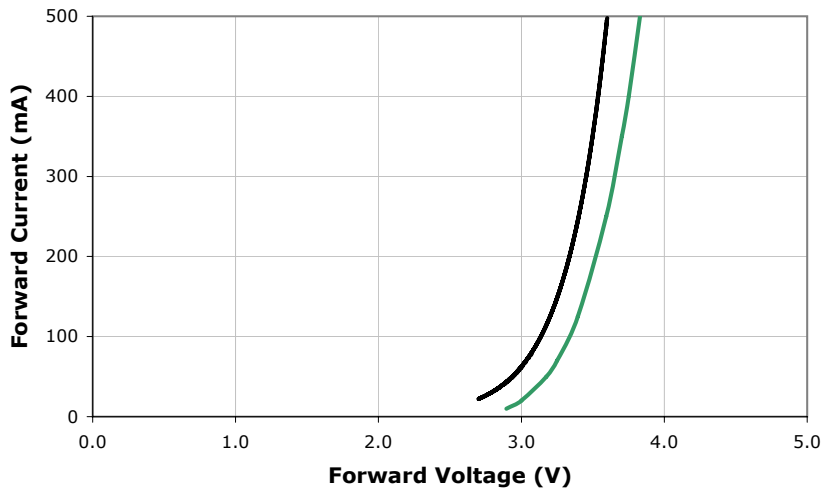

THERMAL DESIGN

The maximum forward current is determined by the thermal resistance between the LED junction and ambient. Given an existing thermal resistance of 12 °C/W or 15 °C/W between the junction and the solder point, it is crucial for the end product to be designed in a manner that minimizes the thermal resistance from the solder point to ambient in order to optimize lamp life and optical characteristics.

**White
Royal Blue
Blue
Green**



Amber



**Red-Orange
Red**



RELATIVE FLUX VS. CURRENT ($T_j = 25^\circ\text{C}$)



TYPICAL SPATIAL DISTRIBUTION



REFLOW SOLDERING CHARACTERISTICS

In testing, Cree has found XLamp XR-C LEDs to be compatible with JEDEC J-STD-020C, using the parameters listed below. As a general guideline, Cree recommends that users follow the recommended soldering profile provided by the manufacturer of solder paste used.

Note that this general guideline may not apply to all PCB designs and configurations of reflow soldering equipment.



| Profile Feature | Lead-Based Solder | Lead-Free Solder |
|---|-------------------|------------------|
| Average Ramp-Up Rate ($T_{S_{max}}$ to T_p) | 3 °C/second max. | 3 °C/second max. |
| Preheat: Temperature Min ($T_{S_{min}}$) | 100 °C | 150 °C |
| Preheat: Temperature Max ($T_{S_{max}}$) | 150 °C | 200 °C |
| Preheat: Time ($t_{s_{min}}$ to $t_{s_{max}}$) | 60-120 seconds | 60-180 seconds |
| Time Maintained Above: Temperature (T_L) | 183 °C | 217 °C |
| Time Maintained Above: Time (t_L) | 60-150 seconds | 60-150 seconds |
| Peak/Classification Temperature (T_p) | 215 °C | 260 °C |
| Time Within 5 °C of Actual Peak Temperature (t_p) | 10-30 seconds | 20-40 seconds |
| Ramp-Down Rate | 6 °C/second max. | 6 °C/second max. |
| Time 25 °C to Peak Temperature | 6 minutes max. | 8 minutes max. |

Note: All temperatures refer to topside of the package, measured on the package body surface.

NOTES

Lumen Maintenance Projections

Cree now uses standardized IES LM-80-08 and TM-21-11 methods for collecting long-term data and extrapolating LED lumen maintenance. For information on the specific LM-80 data sets available for this LED, refer to the public LM-80 results document at www.cree.com/xlamp_app_notes/LM80_results.

Please read the XLamp Long-Term Lumen Maintenance application note at www.cree.com/xlamp_app_notes/lumen_maintenance for more details on Cree’s lumen maintenance testing and forecasting. Please read the XLamp Thermal Management application note at www.cree.com/xlamp_app_notes/thermal_management for details on how thermal design, ambient temperature, and drive current affect the LED junction temperature.

Moisture Sensitivity

XLamp LEDs are shipped in sealed, moisture-barrier bags (MBB) designed for long shelf life. If XLamp LEDs are exposed to moist environments after opening the MBB packaging but before soldering, damage to the LED may occur during the soldering operation. The following derating table defines the maximum exposure time (in days) for an XLamp LED in the listed humidity and temperature conditions. LEDs with exposure time longer than the time specified below must be baked according to the baking conditions listed below.

| Temp. | Maximum Percent Relative Humidity | | | | | | |
|-------|-----------------------------------|-----|-----|-----|-----|-----|-----|
| | 30% | 40% | 50% | 60% | 70% | 80% | 90% |
| 30 °C | 9 | 5 | 4 | 3 | 1 | 1 | 1 |
| 25 °C | 12 | 7 | 5 | 4 | 2 | 1 | 1 |
| 20 °C | 17 | 9 | 7 | 6 | 2 | 2 | 1 |

Cree recommends keeping XLamp LEDs in their sealed moisture-barrier packaging until immediately prior to use. Cree also recommends returning any unused LEDs to the resealable moisture-barrier bag and closing the bag immediately after use.

Baking Conditions

It is not necessary to bake all XLamp LEDs. Only the LEDs that meet all of the following criteria must be baked:

- LEDs that have been removed from the original MBB packaging.
- LEDs that have been exposed to a humid environment longer than listed in the Moisture Sensitivity section above.
- LEDs that have not been soldered.

LEDs should be baked at 80 °C for 24 hours. LEDs may be baked on the original reels. Remove LEDs from MBB packaging before baking. Do not bake parts at temperatures higher than 80 °C. This baking operation resets the exposure time as defined in the Moisture Sensitivity section above.

Storage Conditions

XLamp LEDs that have been removed from original MBB packaging but not soldered yet should be stored in a room or cabinet that will maintain an atmosphere of 25 ± 5 °C and no greater than 10% RH (relative humidity). For LEDs stored in these conditions, storage time does not add to exposure time as defined in the Moisture Sensitivity section above.

NOTES - CONTINUED

RoHS Compliance

The levels of RoHS restricted materials in this product are below the maximum concentration values (also referred to as the threshold limits) permitted for such substances, or are used in an exempted application, in accordance with EU Directive 2011/65/EC (RoHS2), as amended through June 8, 2011. RoHS Declarations for this product can be obtained from your Cree representative or obtained from the Product Ecology section of www.cree.com.

Vision Advisory Claim

WARNING: Do not look at exposed lamp in operation. Eye injury can result. See LED Eye Safety at www.cree.com/xlamp_app_notes/led_eye_safety.

Intellectual Property

For remote phosphor applications, a separate license to certain Cree patents is required.

MECHANICAL DIMENSIONS (TA = 25 °C)

All measurements are ± 0.1 mm unless otherwise indicated.



Side View



Top View

Bottom View



Recommended PC Board Solder Pad

TAPE AND REEL

All Cree carrier tapes conform to EIA-481D, Automated Component Handling Systems Standard.



DRY PACKAGING AND PACKAGING

Unpackaged Reel



Label with Cree Bin Code, Qty, Reel ID

Packaged Reel

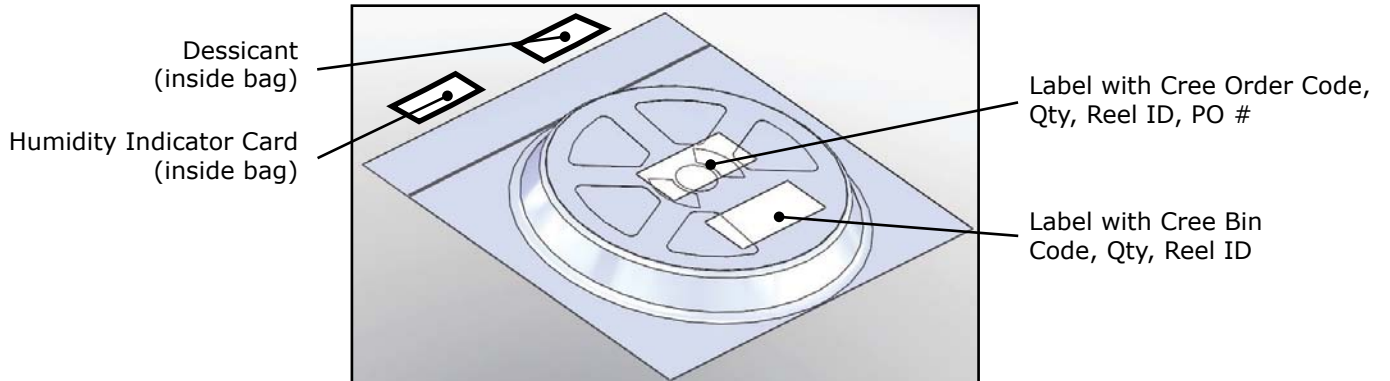

Dessicant (inside bag)

Humidity Indicator Card (inside bag)

Label with Cree Order Code, Qty, Reel ID, PO #

Label with Cree Bin Code, Qty, Reel ID

Boxed Reel

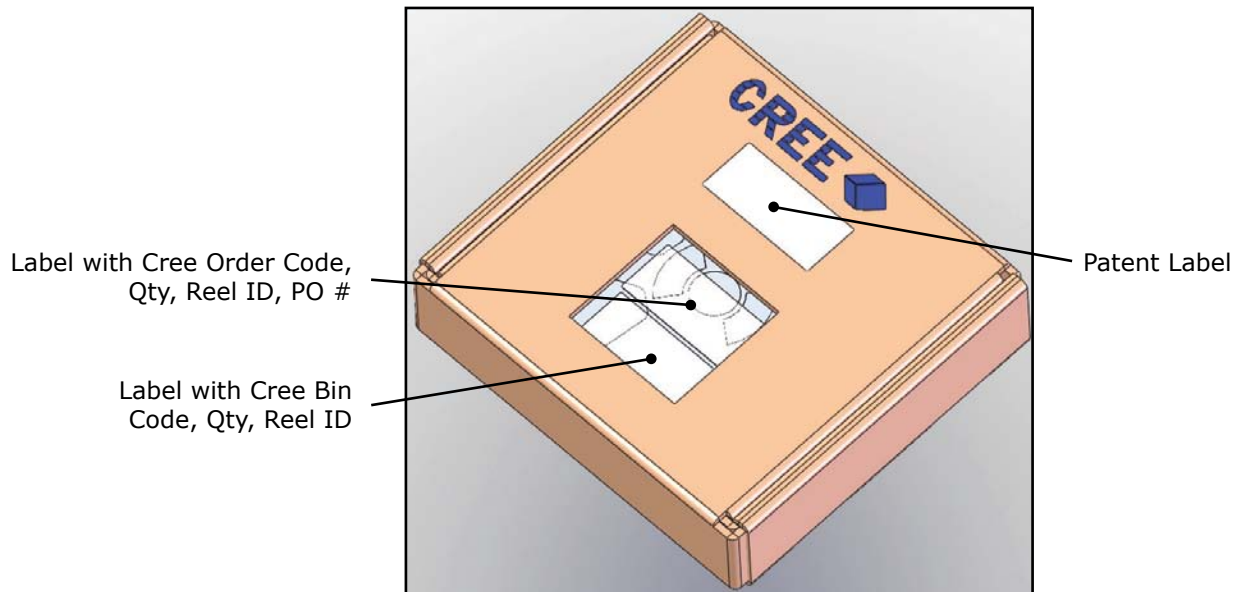

Label with Cree Order Code, Qty, Reel ID, PO #

Label with Cree Bin Code, Qty, Reel ID

Patent Label

Компания «Океан Электроники» предлагает заключение долгосрочных отношений при поставках импортных электронных компонентов на взаимовыгодных условиях!

Наши преимущества:

- Поставка оригинальных импортных электронных компонентов напрямую с производств Америки, Европы и Азии, а так же с крупнейших складов мира;
- Широкая линейка поставок активных и пассивных импортных электронных компонентов (более 30 млн. наименований);
- Поставка сложных, дефицитных, либо снятых с производства позиций;
- Оперативные сроки поставки под заказ (от 5 рабочих дней);
- Экспресс доставка в любую точку России;
- Помощь Конструкторского Отдела и консультации квалифицированных инженеров;
- Техническая поддержка проекта, помощь в подборе аналогов, поставка прототипов;
- Поставка электронных компонентов под контролем ВП;
- Система менеджмента качества сертифицирована по Международному стандарту ISO 9001;
- При необходимости вся продукция военного и аэрокосмического назначения проходит испытания и сертификацию в лаборатории (по согласованию с заказчиком);
- Поставка специализированных компонентов военного и аэрокосмического уровня качества (Xilinx, Altera, Analog Devices, Intersil, Interpoint, Microsemi, Actel, Aeroflex, Peregrine, VPT, Syfer, Eurofarad, Texas Instruments, MS Kennedy, Miteq, Cobham, E2V, MA-COM, Hittite, Mini-Circuits, General Dynamics и др.);

Компания «Океан Электроники» является официальным дистрибьютором и эксклюзивным представителем в России одного из крупнейших производителей разъемов военного и аэрокосмического назначения «JONHON», а так же официальным дистрибьютором и эксклюзивным представителем в России производителя высокотехнологичных и надежных решений для передачи СВЧ сигналов «FORSTAR».



JONHON

«JONHON» (основан в 1970 г.)

Разъемы специального, военного и аэрокосмического назначения:

(Применяются в военной, авиационной, аэрокосмической, морской, железнодорожной, горно- и нефтедобывающей отраслях промышленности)

«FORSTAR» (основан в 1998 г.)

ВЧ соединители, коаксиальные кабели,
кабельные сборки и микроволновые компоненты:

(Применяются в телекоммуникациях гражданского и специального назначения, в средствах связи, РЛС, а так же военной, авиационной и аэрокосмической отраслях промышленности).



Телефон: 8 (812) 309-75-97 (многоканальный)

Факс: 8 (812) 320-03-32

Электронная почта: ocean@oceanchips.ru

Web: <http://oceanchips.ru/>

Адрес: 198099, г. Санкт-Петербург, ул. Калинина, д. 2, корп. 4, лит. А