

### Description

The DGTD65T50S1PT is produced using advanced Field Stop Trench IGBT Technology, which provides excellent quality and high-switching performance.

### Features

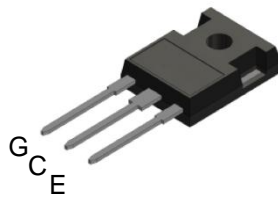
- High-Speed Switching & Low Power Loss
- $V_{CE(sat)} = 1.85V @ I_C = 50A$
- High Input Impedance
- $t_{rr} = 80ns$  (typ) @  $di_f/dt = 1000A/\mu s$
- $E_{off} = 0.55mJ @ T_C = 25^\circ C$
- Maximum Junction Temperature  $175^\circ C$
- **Lead-Free Finish & RoHS Compliant (Notes 1 & 2)**
- **Halogen and Antimony Free. "Green" Device (Note 3)**

### Applications

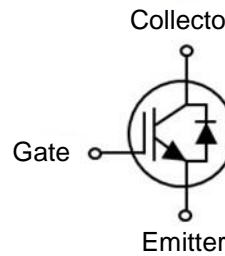
- UPS
- Welder
- Solar Inverter
- IH Cooker

### Mechanical Data

- Case: TO-247 (Type MC)
- Case Material: Molded Plastic. "Green" Molding Compound.
- UL Flammability Classification Rating 94V-0
- Terminals: Finish – Matte Tin Plated Leads.  
Solderable per MIL-STD-202, Method 208 <sup>(E3)</sup>
- Weight: 5.6 grams (Approximate)



TO-247



Device Symbol

### Ordering Information (Note 4)

Product	Marking	Quantity
DGTD65T50S1PT	DGTD65T50S1	450 per Box in Tubes (Note 5)

- Notes:
1. EU Directive 2002/95/EC (RoHS), 2011/65/EU (RoHS 2) & 2015/863/EU (RoHS 3) compliant. All applicable RoHS exemptions applied.
  2. See [http://www.diodes.com/quality/lead\\_free.html](http://www.diodes.com/quality/lead_free.html) for more information about Diodes Incorporated's definitions of Halogen- and Antimony-free, "Green" and Lead-free.
  3. Halogen- and Antimony-free "Green" products are defined as those which contain <900ppm bromine, <900ppm chlorine (<1500ppm total Br + Cl) and <1000ppm antimony compounds.
  4. For packaging details, go to our website at <https://www.diodes.com/design/support/packaging/diodes-packaging/>.
  5. 30 Devices per Tube.

### Marking Information



$\text{D}||$  = Manufacturer's Marking  
 DGTD65T50S1 = Product Type Marking Code  
 YY = Year (ex: 18 = 2018)  
 LLLLL = Lot Code  
 WW = Week (01 to 53)

**Absolute Maximum Ratings** (@T<sub>A</sub> = +25°C, unless otherwise specified.)

Characteristic	Symbol	Value	Unit
Collector-Emitter Voltage	V <sub>CE</sub>	650	V
DC Collector Current, limited by T <sub>vjmax</sub>	I <sub>C</sub>	T <sub>C</sub> = 25°C	100
		T <sub>C</sub> = 100°C	50
Pulsed Collector Current, t <sub>p</sub> limited by T <sub>vjmax</sub>	I <sub>Cpuls</sub>	200	A
Turn Off Safe Operating Area V <sub>CE</sub> ≤ 650V, T <sub>vj</sub> = 175°C	-	200	A
Diode Forward Current limited by T <sub>vjmax</sub>	I <sub>F</sub>	T <sub>C</sub> = 25°C	60
		T <sub>C</sub> = 100°C	30
Diode Pulsed Current, t <sub>p</sub> limited by T <sub>vjmax</sub>	I <sub>Fpuls</sub>	200	A
Gate-Emitter Voltage	V <sub>GE</sub>	±20	V
Short Circuit Withstand Time V <sub>CC</sub> ≤ 400V, V <sub>GE</sub> = 15V, T <sub>vj</sub> = 150°C Allowed Number of Short Circuits < 1000 Time Between Short Circuits ≥ 1.0s	tsc	5	μs

**Thermal Characteristics** (@T<sub>A</sub> = +25°C, unless otherwise specified.)

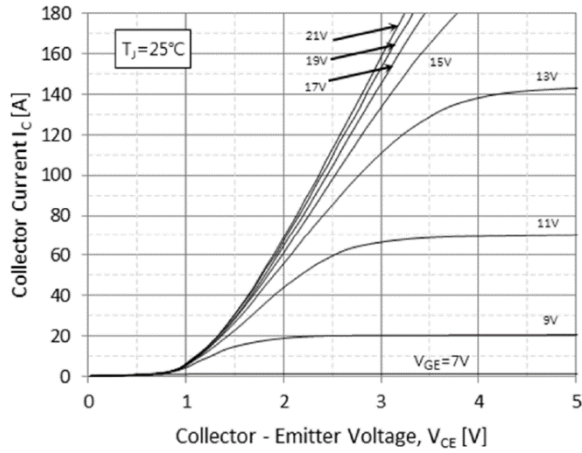
Characteristic	Symbol	Value	Unit
Power Dissipation Linear Derating Factor (Note 6)	P <sub>D</sub>	T <sub>C</sub> = 25°C	375
		T <sub>C</sub> = 100°C	188
Thermal Resistance, Junction to Ambient (Note 6)	R <sub>θJA</sub>	40	°C/W
Thermal Resistance, Junction to Case for IGBT (Note 6)	R <sub>θJC</sub>	0.40	
Thermal Resistance, Junction to Case for Diode (Note 6)	R <sub>θJC</sub>	1.20	
Operating Temperature	T <sub>vj</sub>	-40 to +175	°C
Storage Temperature Range	T <sub>STG</sub>	-55 to +150	

Note: 6. When mounted on a standard JEDEC 2-layer FR-4 board.

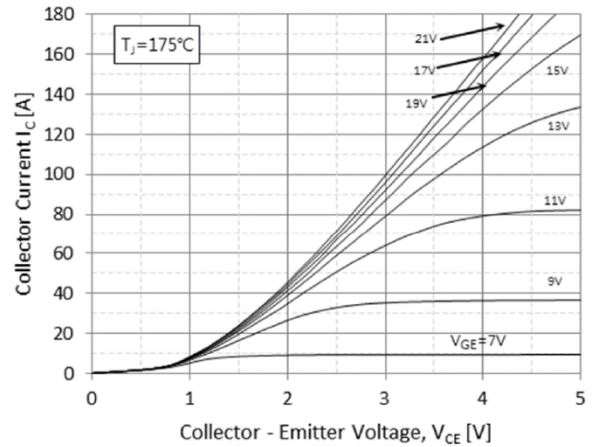
**Electrical Characteristics** (@ $T_{vj} = +25^{\circ}\text{C}$ , unless otherwise specified.)

Parameter	Symbol	Min	Typ	Max	Unit	Condition	
<b>STATIC CHARACTERISTICS</b>							
Collector-Emitter Breakdown Voltage	$BV_{CES}$	650	–	–	V	$I_C = 2\text{mA}, V_{GE} = 0\text{V}$	
Collector-Emitter Saturation Voltage	$V_{CE(sat)}$	$T_{vj} = 25^{\circ}\text{C}$	–	1.85	2.40	V	$I_C = 50\text{A}, V_{GE} = 15\text{V}$
		$T_{vj} = 175^{\circ}\text{C}$	–	2.20	–		
Diode Forward Voltage	$V_F$	$T_{vj} = 25^{\circ}\text{C}$	–	1.65	2.05	V	$V_{GE} = 0\text{V}, I_F = 30\text{A}$
		$T_{vj} = 175^{\circ}\text{C}$	–	1.55	–		
Gate-Emitter Threshold Voltage	$V_{GE(th)}$	3.8	5.0	6.2	V	$V_{CE} = V_{GE}, I_C = 0.5\text{mA}$	
Zero Gate Voltage Collector Current	$I_{CES}$	–	–	40	$\mu\text{A}$	$V_{CE} = 650\text{V}, V_{GE} = 0\text{V}$	
Gate-Emitter Leakage Current	$I_{GES}$	–	–	$\pm 100$	nA	$V_{GE} = 20\text{V}, V_{CE} = 0\text{V}$	
<b>DYNAMIC CHARACTERISTICS</b>							
Total Gate Charge	$Q_g$	–	287	–	nC	$V_{CE} = 520\text{V}, I_C = 50\text{A}, V_{GE} = 15\text{V}$	
Gate-Emitter Charge	$Q_{ge}$	–	42	–			
Gate-Collector Charge	$Q_{gc}$	–	181	–			
Input Capacitance	$C_{ies}$	–	4,453	–	pF	$V_{CE} = 25\text{V}, V_{GE} = 0\text{V}, f = 1\text{MHz}$	
Reverse Transfer Capacitance	$C_{res}$	–	161	–			
Output Capacitance	$C_{oes}$	–	238	–			
Internal Emitter Inductance Measured 5mm (0.197") From Case	$L_E$	–	13	–	nH	–	
Short Circuit Collector Current Max. 1000 Short Circuits. Time Between Short Circuits $\geq 1.0\text{s}$	$I_{C(SC)}$	–	140	–	A	$V_{GE} = 15\text{V}, V_{CC} = 400\text{V}, t_{SC} \leq 5\mu\text{s}, T_{vj} = 150^{\circ}\text{C}$	
<b>SWITCHING CHARACTERISTICS</b>							
Turn-on Delay Time	$t_{d(on)}$	–	58	–	ns	$V_{GE} = 15\text{V}, V_{CC} = 400\text{V}, I_C = 50\text{A}, R_G = 7.9\Omega, \text{Inductive Load}, T_{vj} = 25^{\circ}\text{C}$	
Rise time	$t_r$	–	60	–			
Turn-off Delay Time	$t_{d(off)}$	–	328	–			
Fall Time	$t_f$	–	44	–	mJ		
Turn-on Switching Energy	$E_{on}$	–	0.77	–			
Turn-off Switching Energy	$E_{off}$	–	0.55	–			
Total Switching Energy	$E_{ts}$	–	1.32	–	ns	$I_F = 30\text{A}, di_F/dt = 1000\text{A}/\mu\text{s}, T_{vj} = 25^{\circ}\text{C}$	
Reverse Recovery Time	$t_{rr}$	–	80	–			
Reverse Recovery Current	$I_{rr}$	–	24	–			
Reverse Recovery Charge	$Q_{rr}$	–	0.95	–	$\mu\text{C}$	$V_{GE} = 15\text{V}, V_{CC} = 400\text{V}, I_C = 50\text{A}, R_G = 7.9\Omega, \text{Inductive Load}, T_{vj} = 175^{\circ}\text{C}$	
Turn-on Delay Time	$t_{d(on)}$	–	51	–	ns		
Rise time	$t_r$	–	66	–			
Turn-off Delay Time	$t_{d(off)}$	–	350	–		mJ	
Fall Time	$t_f$	–	49	–			
Turn-on Switching Energy	$E_{on}$	–	1.05	–			
Turn-off Switching Energy	$E_{off}$	–	0.55	–	ns	$I_F = 30\text{A}, di_F/dt = 1000\text{A}/\mu\text{s}, T_{vj} = 175^{\circ}\text{C}$	
Total Switching Energy	$E_{ts}$	–	1.6	–			
Reverse Recovery Time	$t_{rr}$	–	116	–			
Reverse Recovery Current	$I_{rr}$	–	34	–	A	$I_F = 30\text{A}, di_F/dt = 1000\text{A}/\mu\text{s}, T_{vj} = 175^{\circ}\text{C}$	
Reverse Recovery Charge	$Q_{rr}$	–	1.97	–	$\mu\text{C}$		

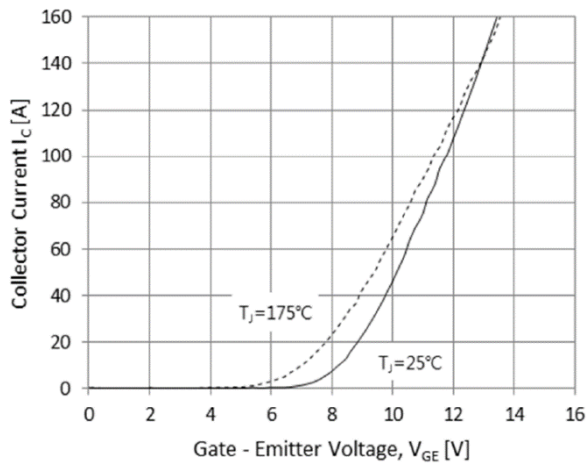
**Typical Performance Characteristics** (@ $T_A = +25^\circ\text{C}$ , unless otherwise specified.)



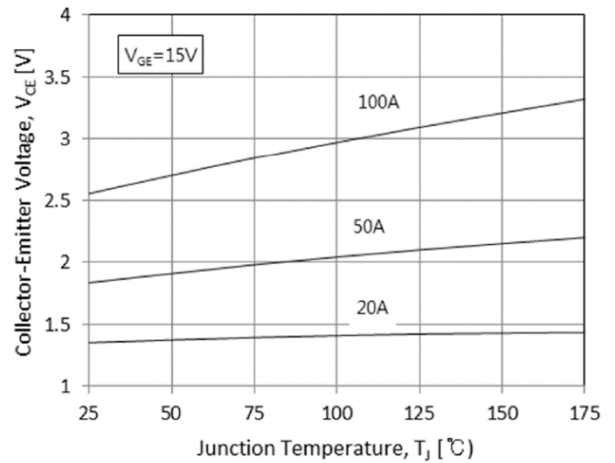
**Fig.1 Typical Output Characteristics ( $T_J = 25^\circ\text{C}$ )**



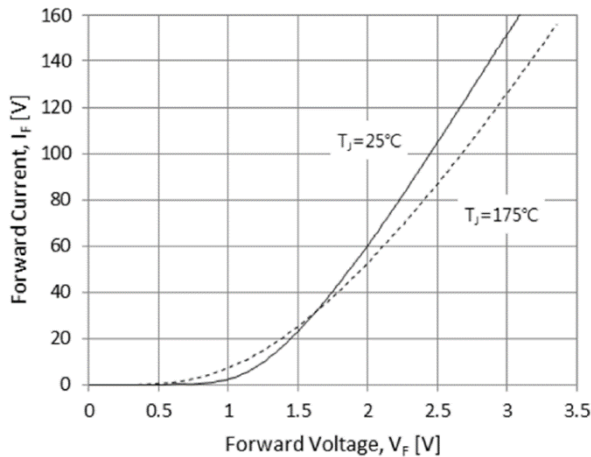
**Fig.2 Typical Output Characteristics ( $T_J = 175^\circ\text{C}$ )**



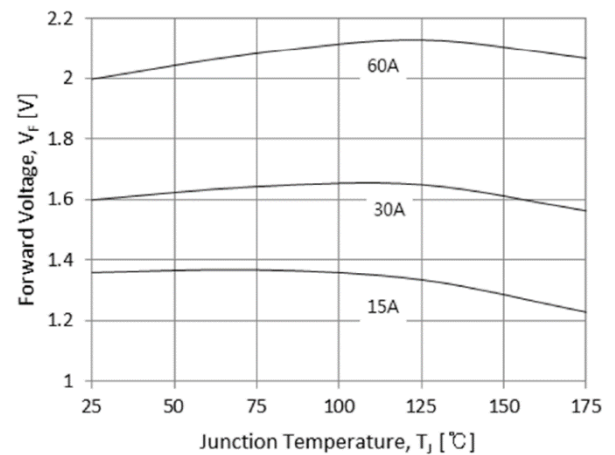
**Fig.3 Typical Transfer Characteristics**



**Fig.4 Typical Collector-Emitter Saturation Voltage - Junction Temperature**

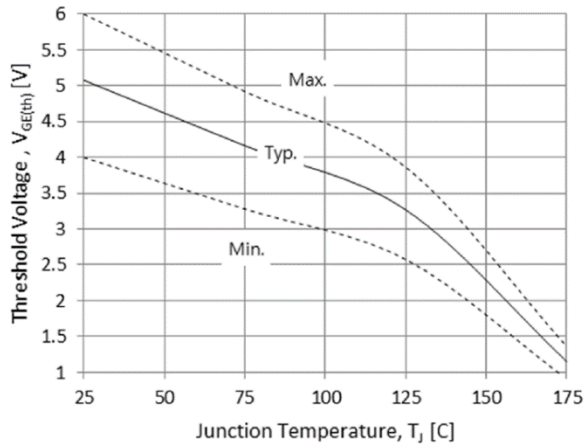


**Fig.5 Diode Forward Characteristics**

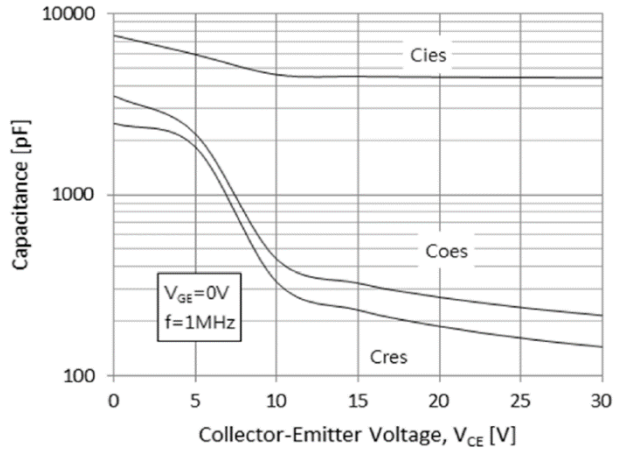


**Fig.6 Diode Forward-Junction Temperature**

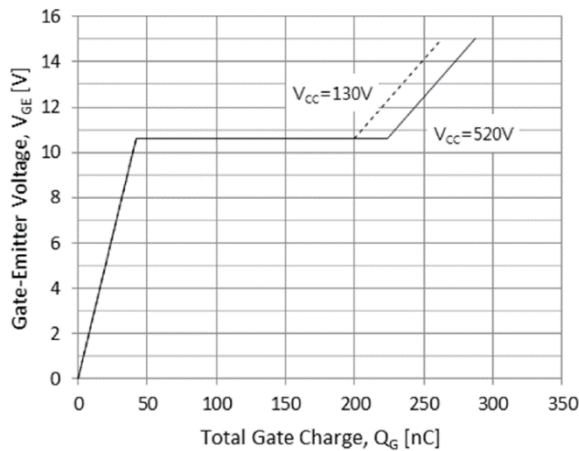
**Typical Performance Characteristics** (continued)



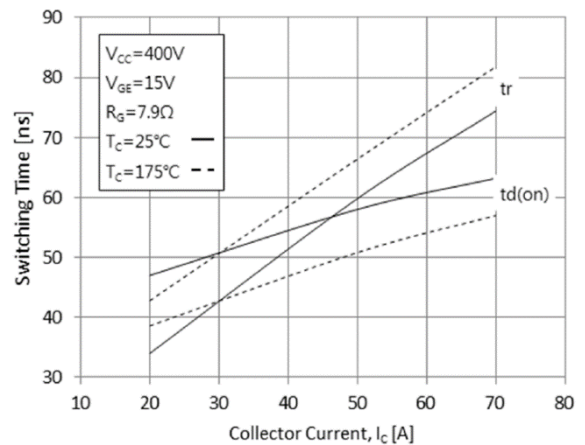
**Fig.7 Threshold Voltage-Junction Temperature**



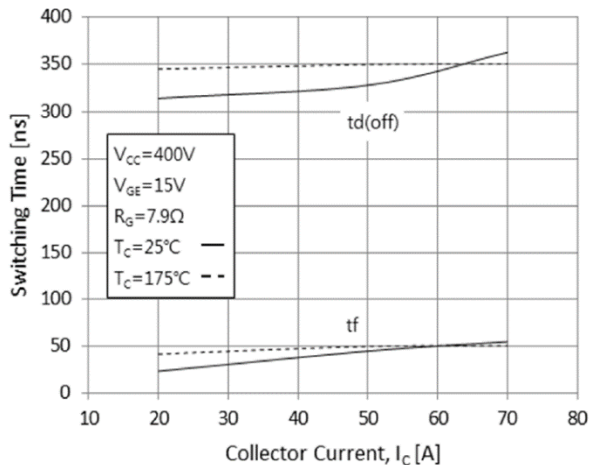
**Fig.8 Typical Capacitance**



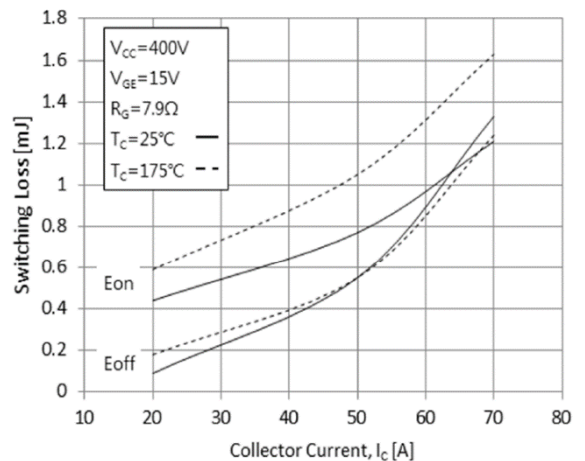
**Fig.9 Typical Gate Charge**



**Fig.10 Typical Turn on-Collector Current**

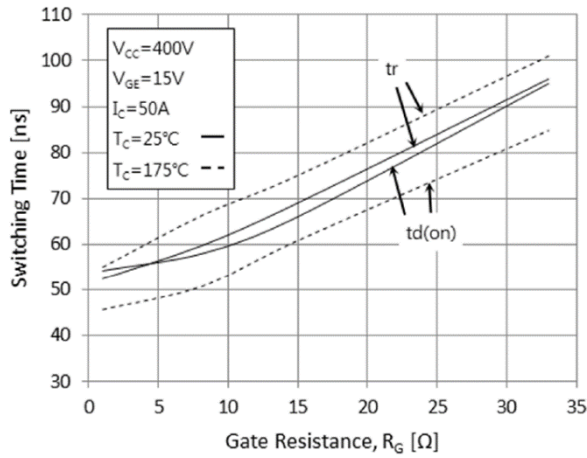


**Fig.11 Typical Turn off-Collector Current**

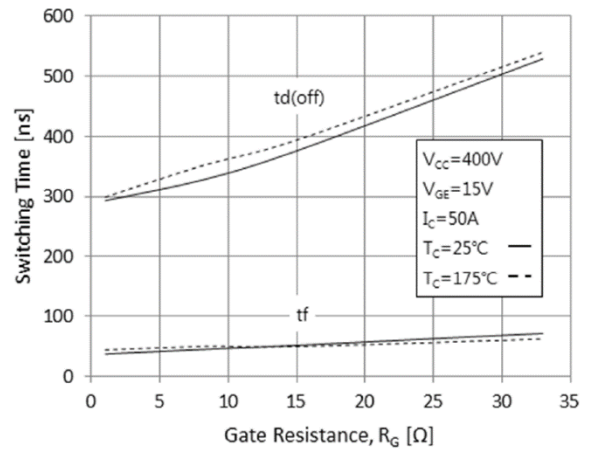


**Fig.12 Switching Loss-Collector Current**

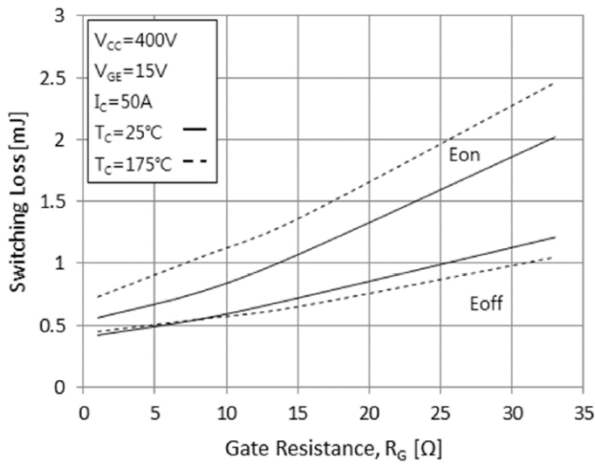
**Typical Performance Characteristics (cont.)**



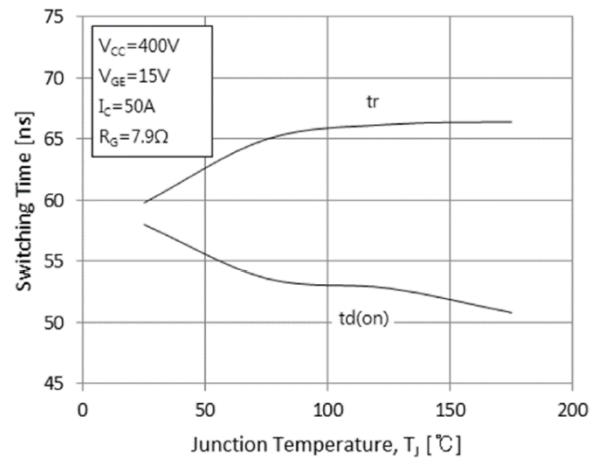
**Fig.13 Turn on Characteristics-Gate Resistance**



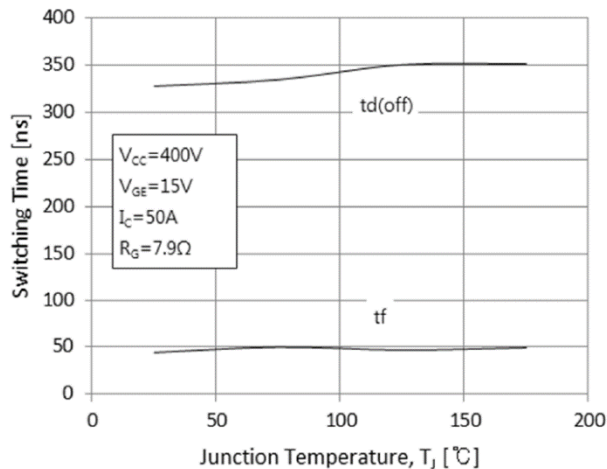
**Fig.14 Turn off Characteristics-Gate Resistance**



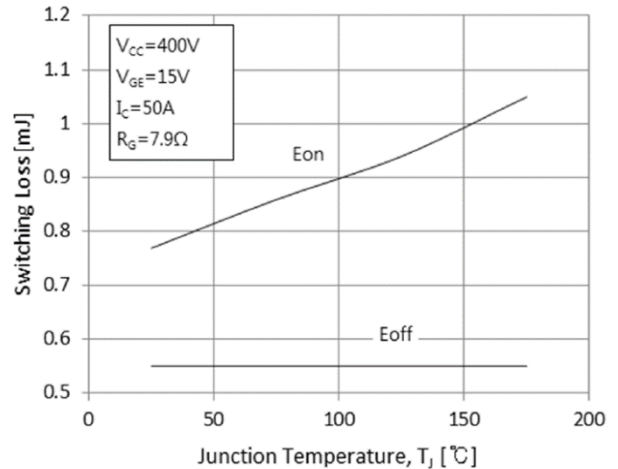
**Fig.15 Switching Loss-Gate Resistance**



**Fig.16 Turn on Characteristics-Junction Temperature**



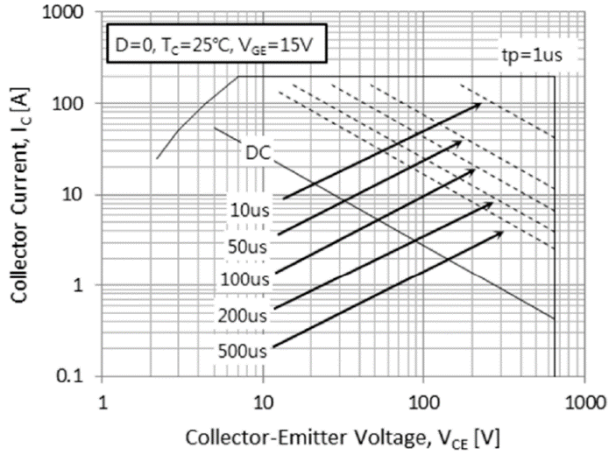
**Fig.17 Turn off Characteristics-Junction Temperature**



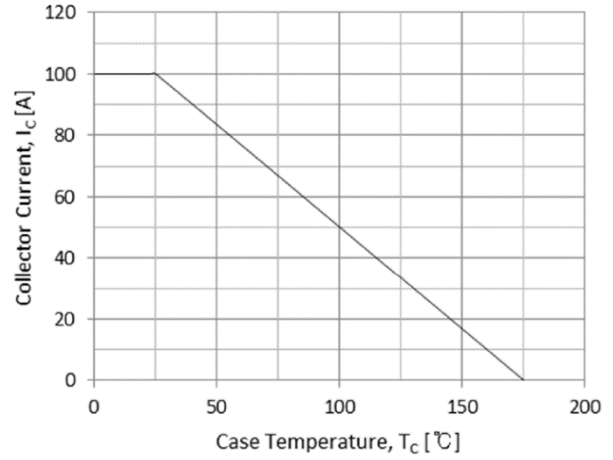
**Fig.18 Switching Loss-Junction Temperature**



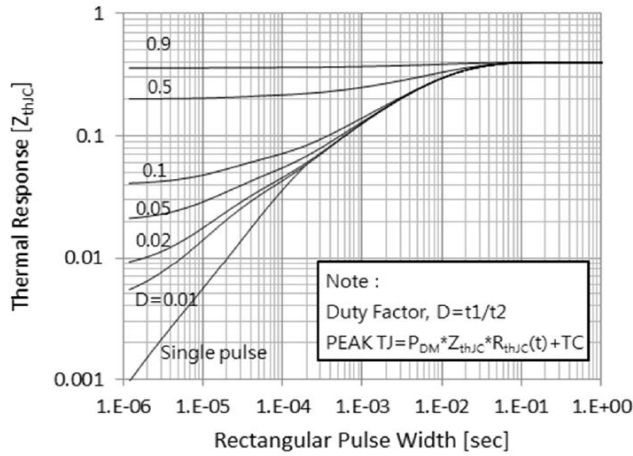
**Typical Performance Characteristics (cont.)**



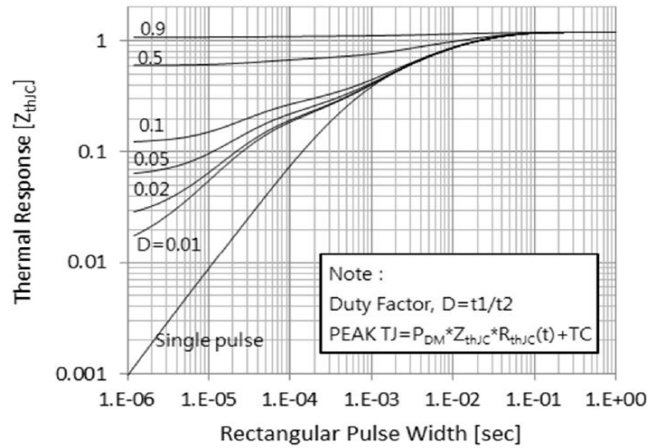
**Fig.19 Forward Bias Safe Operating Area**



**Fig.20 Case Temperature-Collector Current**



**Fig.21 IGBT Transient Thermal Impedance**

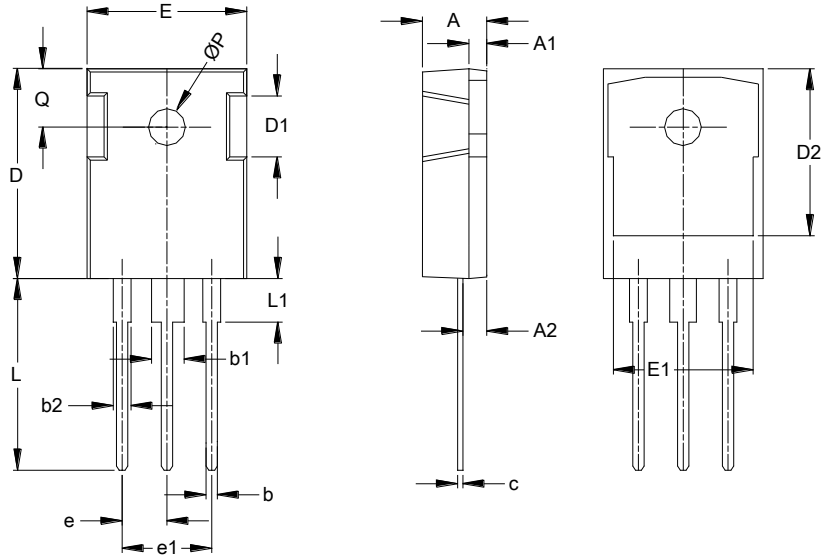


**Fig.22 FRD Transient Thermal Impedance**

**Package Outline Dimensions**

Please see <http://www.diodes.com/package-outlines.html> for the latest version.

**TO-247 (Type MC)**



TO-247 (Type MC)			
Dim	Min	Max	Typ
A	4.700	5.310	-
A1	1.500	2.490	-
A2	2.200	2.600	-
b	0.990	1.400	-
b1	2.590	3.430	-
b2	1.650	2.390	-
c	0.380	0.890	-
D	20.30	21.46	-
D1	4.320	5.490	-
D2	13.08	-	-
E	15.45	16.26	-
E1	13.06	14.02	-
e	5.450		
e1	10.90		
L	19.81	20.57	-
L1	-	4.500	-
Q	5.380	6.200	-
øP	3.500	3.700	-
All Dimensions in mm			

Note : For high-voltage applications, the appropriate industry sector guidelines should be considered with regards to creepage and clearance distances between device Terminals and PCB tracking.



**IMPORTANT NOTICE**

DIODES INCORPORATED MAKES NO WARRANTY OF ANY KIND, EXPRESS OR IMPLIED, WITH REGARDS TO THIS DOCUMENT, INCLUDING, BUT NOT LIMITED TO, THE IMPLIED WARRANTIES OF MERCHANTABILITY AND FITNESS FOR A PARTICULAR PURPOSE (AND THEIR EQUIVALENTS UNDER THE LAWS OF ANY JURISDICTION).

Diodes Incorporated and its subsidiaries reserve the right to make modifications, enhancements, improvements, corrections or other changes without further notice to this document and any product described herein. Diodes Incorporated does not assume any liability arising out of the application or use of this document or any product described herein; neither does Diodes Incorporated convey any license under its patent or trademark rights, nor the rights of others. Any Customer or user of this document or products described herein in such applications shall assume all risks of such use and will agree to hold Diodes Incorporated and all the companies whose products are represented on Diodes Incorporated website, harmless against all damages.

Diodes Incorporated does not warrant or accept any liability whatsoever in respect of any products purchased through unauthorized sales channel. Should Customers purchase or use Diodes Incorporated products for any unintended or unauthorized application, Customers shall indemnify and hold Diodes Incorporated and its representatives harmless against all claims, damages, expenses, and attorney fees arising out of, directly or indirectly, any claim of personal injury or death associated with such unintended or unauthorized application.

Products described herein may be covered by one or more United States, international or foreign patents pending. Product names and markings noted herein may also be covered by one or more United States, international or foreign trademarks.

This document is written in English but may be translated into multiple languages for reference. Only the English version of this document is the final and determinative format released by Diodes Incorporated.

**LIFE SUPPORT**

Diodes Incorporated products are specifically not authorized for use as critical components in life support devices or systems without the express written approval of the Chief Executive Officer of Diodes Incorporated. As used herein:

A. Life support devices or systems are devices or systems which:

1. are intended to implant into the body, or
2. support or sustain life and whose failure to perform when properly used in accordance with instructions for use provided in the labeling can be reasonably expected to result in significant injury to the user.

B. A critical component is any component in a life support device or system whose failure to perform can be reasonably expected to cause the failure of the life support device or to affect its safety or effectiveness.

Customers represent that they have all necessary expertise in the safety and regulatory ramifications of their life support devices or systems, and acknowledge and agree that they are solely responsible for all legal, regulatory and safety-related requirements concerning their products and any use of Diodes Incorporated products in such safety-critical, life support devices or systems, notwithstanding any devices- or systems-related information or support that may be provided by Diodes Incorporated. Further, Customers must fully indemnify Diodes Incorporated and its representatives against any damages arising out of the use of Diodes Incorporated products in such safety-critical, life support devices or systems.

Copyright © 2018, Diodes Incorporated

**[www.diodes.com](http://www.diodes.com)**

Компания «Океан Электроники» предлагает заключение долгосрочных отношений при поставках импортных электронных компонентов на взаимовыгодных условиях!

Наши преимущества:

- Поставка оригинальных импортных электронных компонентов напрямую с производств Америки, Европы и Азии, а так же с крупнейших складов мира;
- Широкая линейка поставок активных и пассивных импортных электронных компонентов (более 30 млн. наименований);
- Поставка сложных, дефицитных, либо снятых с производства позиций;
- Оперативные сроки поставки под заказ (от 5 рабочих дней);
- Экспресс доставка в любую точку России;
- Помощь Конструкторского Отдела и консультации квалифицированных инженеров;
- Техническая поддержка проекта, помощь в подборе аналогов, поставка прототипов;
- Поставка электронных компонентов под контролем ВП;
- Система менеджмента качества сертифицирована по Международному стандарту ISO 9001;
- При необходимости вся продукция военного и аэрокосмического назначения проходит испытания и сертификацию в лаборатории (по согласованию с заказчиком);
- Поставка специализированных компонентов военного и аэрокосмического уровня качества (Xilinx, Altera, Analog Devices, Intersil, Interpoint, Microsemi, Actel, Aeroflex, Peregrine, VPT, Syfer, Eurofarad, Texas Instruments, MS Kennedy, Miteq, Cobham, E2V, MA-COM, Hittite, Mini-Circuits, General Dynamics и др.);

Компания «Океан Электроники» является официальным дистрибьютором и эксклюзивным представителем в России одного из крупнейших производителей разъемов военного и аэрокосмического назначения «JONHON», а так же официальным дистрибьютором и эксклюзивным представителем в России производителя высокотехнологичных и надежных решений для передачи СВЧ сигналов «FORSTAR».



## JONHON

«JONHON» (основан в 1970 г.)

Разъемы специального, военного и аэрокосмического назначения:

(Применяются в военной, авиационной, аэрокосмической, морской, железнодорожной, горно- и нефтедобывающей отраслях промышленности)

«FORSTAR» (основан в 1998 г.)

ВЧ соединители, коаксиальные кабели,  
кабельные сборки и микроволновые компоненты:

(Применяются в телекоммуникациях гражданского и специального назначения, в средствах связи, РЛС, а так же военной, авиационной и аэрокосмической отраслях промышленности).



Телефон: 8 (812) 309-75-97 (многоканальный)

Факс: 8 (812) 320-03-32

Электронная почта: [ocean@oceanchips.ru](mailto:ocean@oceanchips.ru)

Web: <http://oceanchips.ru/>

Адрес: 198099, г. Санкт-Петербург, ул. Калинина, д. 2, корп. 4, лит. А