

### FEATURES

**50ns max Switching Time Over Full Temperature Range**

**Low R<sub>ON</sub> (30Ω typ)**

**Single Supply Specifications for +10.8V to +16.5V Operation**

**Extended Plastic Temperature Range (-40°C to +85°C)**

**Break-Before-Make Switching**

**Low Leakage (100pA typ)**

**44V Supply max Rating**

**Available in 16-Lead DIP/SOIC and 20-Lead LCCC/PLCC Packages**

**ADG201HS (K, B, T) Replaces HI-201HS**

**ADG201HS (J, A, S) Replaces DG271**

### GENERAL DESCRIPTION

The ADG201HS is a monolithic CMOS device comprising four independently selectable SPST switches. It is designed on an enhanced LC<sup>2</sup>MOS process which gives very fast switching speeds and low R<sub>ON</sub>.

The switches also feature break-before-make switching action for use in multiplexer applications and low charge injection for minimum transients on the output when switching the digital inputs.

### ORDERING GUIDE

Model <sup>1</sup>	Temperature Range	Package Option <sup>2</sup>
ADG201HSJN	-40°C to +85°C	N-16
ADG201HSKN	-40°C to +85°C	N-16
ADG201HSKR	-40°C to +85°C	R-16
ADG201HSAQ	-40°C to +85°C	Q-16
ADG201HSBQ	-40°C to +85°C	Q-16
ADG201HSJP	-40°C to +85°C	P-20A
ADG201HSKP	-40°C to +85°C	P-20A
ADG201HSSQ	-55°C to +125°C	Q-16
ADG201HSTQ <sup>3</sup>	-55°C to +125°C	Q-16
ADG201HSTE <sup>3</sup>	-55°C to +125°C	E-20A

#### NOTES

<sup>1</sup>To order MIL-STD-883, Class B processed parts, add /883B to T grade part numbers. See the Analog Devices Military Products Databook (1994) for military data sheet.

<sup>2</sup>E = Leadless Ceramic Chip Carrier; N = Narrow Plastic DIP; P = Plastic Leaded Chip Carrier; Q = Cerdip; R = 0.15" Small Outline IC (SOIC).

<sup>3</sup>Standard Military Drawing (SMD) approved by DESC. SMD numbers are

5962-86716012X (ADG201HSTE/883B)

5962-8671601EX (ADG201HSTQ/883B)

### FUNCTIONAL BLOCK DIAGRAM

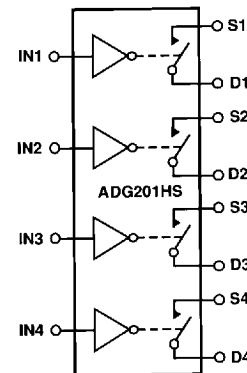

### PRODUCT HIGHLIGHTS

#### 1. 50ns max t<sub>ON</sub> and t<sub>OFF</sub>:

The ADG201HS top grades (K, B, T) have guaranteed 50ns max turn-on and turn-off times over the full operating temperature range. The lower grades (J,A,S) have guaranteed 75ns switching times over the full operating temperature range.

#### 2. Single Supply Specifications:

The ADG201HS is fully specified for applications which require a single positive power supply in the +10.8V to +16.5V range.

#### 3. Low Leakage:

Leakage currents in the range of 100pA make these switches suitable for high precision circuits. The added feature of break-before-make allows for multiple outputs to be tied together for multiplexer applications while keeping leakage errors to a minimum.

IN	Switch Condition
0	ON
1	OFF

Truth Table

### REV. B

Information furnished by Analog Devices is believed to be accurate and reliable. However, no responsibility is assumed by Analog Devices for its use, nor for any infringements of patents or other rights of third parties which may result from its use. No license is granted by implication or otherwise under any patent or patent rights of Analog Devices.

# ADG201HS — SPECIFICATIONS

**DUAL SUPPLY** ( $V_{DD} = +13.5V$  to  $+16.5V$ ,  $= -13.5V$  to  $-16.5V$ ,  $GND = 0V$ ,  
 $V_{IN} = 3V$  [Logic High Level] or  $0.8V$  [Logic Low Level] unless otherwise noted)

Parameter	Version	+25°C	$T_{min} - T_{max}$ <sup>1</sup>	Units	Comments
<b>ANALOG SWITCH</b>					
Analog Signal Range	All	$V_{SS}$	$V_{SS}$	V min	
	All	$V_{DD}$	$V_{DD}$	V max	
$R_{ON}$	All	30	–	$\Omega$ typ	$-10V \leq V_S \leq +10V$ , $I_{DS} = 1mA$ ; Test Circuit 1
	All	50	75	$\Omega$ max	
$R_{ON}$ Drift	All	0.5	–	%/°C typ	$-10V \leq V_S \leq +10V$ , $I_{DS} = 1mA$
$R_{ON}$ Match	All	3	–	% typ	$-10V \leq V_S \leq +10V$ , $I_{DS} = 1mA$
$I_S$ (OFF), Off Input Leakage <sup>2</sup>	All	0.1	–	nA typ	$V_D = \pm 14V$ ; $V_S = \mp 14V$ ; Test Circuit 2
	J, K, A, B	1	20	nA max	
	S, T	1	60	nA max	
$I_D$ (OFF), Off Output Leakage <sup>2</sup>	All	0.1	–	nA typ	$V_D = \pm 14V$ ; $V_S = \mp 14V$ ; Test Circuit 2
	J, K, A, B	1	20	nA max	
	S, T	1	60	nA max	
$I_D$ (ON), On Channel Leakage <sup>2</sup>	All	0.1	–	nA typ	$V_D = V_S = \pm 14V$ ; Test Circuit 3
	J, K, A, B	1	20	nA max	
	S, T	1	60	nA max	
<b>DIGITAL CONTROL</b>					
$V_{INH}$ , Input High Voltage	All	2.4	2.4	V min	
$V_{INL}$ , Input Low Voltage	All	0.8	0.8	V max	
$I_{INL}$ or $I_{INH}$	All	1	1	$\mu A$ max	
$C_{IN}$	All	8	8	pF max	
<b>DYNAMIC CHARACTERISTICS</b>					
$t_{ON}$	K, B, T	50	50	ns max	Test Circuit 4
	J, A, S	75	75	ns max	
$t_{OFF1}$	K, B, T	50	50	ns max	Test Circuit 4
	J, A, S	75	75	ns max	
$t_{OFF2}$	All	150	–	ns typ	Test Circuit 4
$t_{OPEN}$	All	5	5	ns typ	$t_{ON} - t_{OFF1}$ ; Test Circuit 4
Output Settling Time to 0.1%	All	180	–	ns typ	$V_{IN} = 3V$ to $0V$ ; Test Circuit 4
OFF Isolation	All	72	–	dB typ	$V_S = 3V$ rms, $f = 100kHz$ , $R_L = 1k\Omega$ ; $C_L = 10pF$ ; Test Circuit 5
Channel-to-Channel Crosstalk	All	86	–	dB typ	$V_S = 3V$ rms, $f = 100kHz$ , $R_L = 1k\Omega$ ; $C_L = 10pF$ ; Test Circuit 6
$Q_{INJ}$ , Charge Injection	All	10	–	pC typ	$R_S = 0\Omega$ , $V_S = 0V$ ; Test Circuit 7
$C_S$ (OFF)	All	10	–	pF typ	
$C_D$ (OFF)	All	10	–	pF typ	
$C_D$ , $C_S$ (ON)	All	30	–	pF typ	
$C_{DS}$ (OFF)	All	0.5	–	pF typ	
<b>POWER SUPPLY</b>					
$I_{DD}$	All	10	10	mA max	
$I_{SS}$	All	6	6	mA max	
Power Dissipation	All	240	240	mW max	$V_{DD} = +15V$ , $V_{SS} = -15V$

## NOTES

<sup>1</sup>Temperature ranges are as follows: ADG201HSJ, K;  $-40^\circ C$  to  $+85^\circ C$   
 ADG201HSA, B;  $-40^\circ C$  to  $+85^\circ C$   
 ADG201HSS, T;  $-55^\circ C$  to  $+125^\circ C$

<sup>2</sup>Leakage specifications apply with a  $V_D$  ( $V_S$ ) of  $\pm 14V$  or with a  $V_D$  ( $V_S$ ) of  $0.5V$  within the supply voltages ( $V_{DD}$ ,  $V_{SS}$ ), whichever is the minimum.  
 Specifications subject to change without notice.

**SINGLE SUPPLY** ( $V_{DD} = +10.8V$  to  $+16.5V$ ,  $V_{SS} = GND = 0V$ ,  $V_{IN} = 3V$  [Logic High Level] or  $0.8V$  [Logic Low Level] unless otherwise noted)

Parameter	Version	+25°C	$T_{min} - T_{max}$	Units	Comments
<b>ANALOG SWITCH</b>					
Analog Signal Range	All	$V_{SS}$	$V_{SS}$	V min	
	All	$V_{DD}$	$V_{DD}$	V max	
$R_{ON}$	All	65	–	$\Omega$ typ	$0V \leq V_S \leq +10V$ , $I_{DS} = 1mA$ ; Test Circuit 1
	All	90	120	$\Omega$ max	
$R_{ON}$ Drift	All	0.5	–	%/°C typ	$0V \leq V_S \leq +10V$ , $I_{DS} = 1mA$
$R_{ON}$ Match	All	3	–	% typ	$0V \leq V_S \leq +10V$ , $I_{DS} = 1mA$
$I_S$ (OFF), Off Input Leakage <sup>1</sup>	All	0.1	–	nA typ	$V_D = +10V/+0.5V$ ; $V_S = +0.5V/+10V$ ; Test Circuit 2
	J, K, A, B	1	20	nA max	
	S, T	1	60	nA max	
$I_D$ (OFF), Off Output Leakage <sup>1</sup>	All	0.1	–	nA typ	$V_D = +10V/+0.5V$ ; $V_S = +0.5V/+10V$ ; Test Circuit 2
	J, K, A, B	1	20	nA max	
	S, T	1	60	nA max	
$I_D$ (ON), On Channel Leakage <sup>1</sup>	All	0.1	–	nA typ	$V_D = V_S = +10V/+0.5V$ ; Test Circuit 3
	J, K, A, B	1	20	nA max	
	S, T	1	60	nA max	
<b>DIGITAL CONTROL</b>					
$V_{INH}$ , Input High Voltage	All	2.4	2.4	V min	
$V_{INL}$ , Input Low Voltage	All	0.8	0.8	V max	
$I_{INL}$ or $I_{INH}$	All	1	1	$\mu A$ max	
$C_{IN}$	All	8	8	pF max	
<b>DYNAMIC CHARACTERISTICS</b>					
$t_{ON}$	K, B, T	50	70	ns max	Test Circuit 4
	J, A, S	75	90	ns max	
$t_{OFF1}$	K, B, T	50	70	ns max	Test Circuit 4
	J, A, S	75	90	ns max	
$t_{OFF2}$	All	150	–	ns typ	Test Circuit 4
$t_{OPEN}$	All	5	5	ns typ	$t_{ON} - t_{OFF1}$ ; Test Circuit 4
Output Settling Time to 0.1%	All	180	–	ns typ	$V_{IN} = 3V$ to $0V$ ; Test Circuit 4
OFF Isolation	All	72	–	dB typ	$V_S = 3V$ rms, $f = 100kHz$ , $R_L = 1k\Omega$ ; $C_L = 10pF$ ; Test Circuit 5
Channel-to-Channel Crosstalk	All	86	–	dB typ	$V_S = 3V$ rms, $f = 100kHz$ , $R_L = 1k\Omega$ ; $C_L = 10pF$ ; Test Circuit 6
$Q_{INJ}$ , Charge Injection	All	10	–	pC typ	$R_S = 0\Omega$ , $V_S = 0V$ ; Test Circuit 7
$C_S$ (OFF)	All	10	–	pF typ	
$C_D$ (OFF)	All	10	–	pF typ	
$C_D$ , $C_S$ (ON)	All	30	–	pF typ	
$C_{DS}$ (OFF)	All	0.5	–	pF typ	
<b>POWER SUPPLY</b>					
$I_{DD}$	All	10	10	mA max	
Power Dissipation	All	150	150	mW max	$V_{DD} = +15V$

## NOTE

<sup>1</sup>The leakage specifications degrade marginally (typically 1nA at 25°C) with  $V_D(V_S) = V_{SS}$ .

Specifications subject to change without notice.

# ADG201HS

## ABSOLUTE MAXIMUM RATINGS\*

(T<sub>A</sub> = 25°C unless otherwise noted)

V <sub>DD</sub> to V <sub>SS</sub> . . . . .	44V
V <sub>DD</sub> to GND . . . . .	-0.3V, 25V
V <sub>SS</sub> to GND <sup>1</sup> . . . . .	+0.3V, -25V
Analog Inputs <sup>2</sup>	
Voltage at S, D . . . . .	V <sub>SS</sub> - 2V to V <sub>DD</sub> + 2V or 20mA, Whichever Occurs First
Continuous Current, S or D . . . . .	20mA
Pulsed Current S or D . . . . .	20mA
I <sub>ms</sub> Duration, 10% Duty Cycle . . . . .	70mA
Digital Inputs <sup>2</sup>	
Voltage at IN . . . . .	V <sub>SS</sub> - 4V to V <sub>DD</sub> + 4V or 20mA, Whichever Occurs First

## Power Dissipation (Any Package)

Up to +75°C . . . . .	470mW
Derates above +75°C by . . . . .	6mW/°C

## Operating Temperature

Commerical (J, K Version) . . . . .	-40°C to +85°C
Industrial (A, B Version) . . . . .	-40°C to +85°C
Extended (S, T Version) . . . . .	-55°C to +125°C
Storage Temperature Range . . . . .	-65°C to +150°C
Lead Temperature (Soldering 10sec) . . . . .	+300°C

## NOTES

<sup>1</sup>If V<sub>SS</sub> is open circuited with V<sub>DD</sub> and GND applied, the V<sub>SS</sub> pin will be pulled positive, exceeding the Absolute Maximum Ratings. If this possibility exists, a Schottky diode from V<sub>SS</sub> to GND (cathode end to GND) ensures that the Absolute Maximum Ratings will be observed.

<sup>2</sup>Overtoltage at IN, S or D, will be clamped by diodes. Current should be limited to the maximum rating above.

\*COMMENT: Stresses above those listed under "Absolute Maximum Ratings" may cause permanent damage to the device. This is a stress rating only and functional operation of the device at these or any other conditions above those indicated in the operational sections of this specification is not implied. Exposure to absolute maximum rating conditions for extended periods may affect device reliability.

## CAUTION:

ESD (electrostatic discharge) sensitive device. The digital control inputs are diode protected; however, permanent damage may occur on unconnected devices subject to high energy electrostatic fields. Unused devices must be stored in conductive foam or shunts. The protective foam should be discharged to the destination socket before devices are inserted.



## PIN CONFIGURATIONS

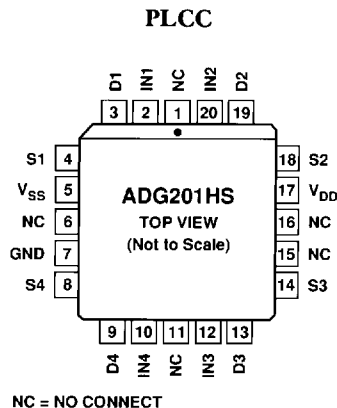
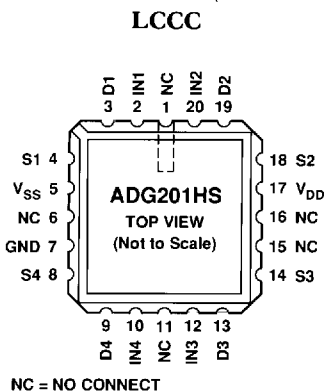
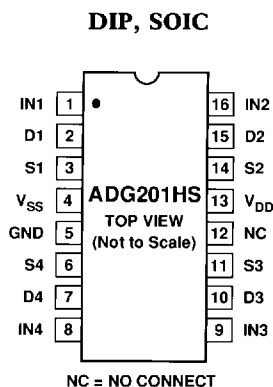

# Typical Performance Characteristics—ADG201HS

The switches are guaranteed functional with reduced single or dual supplies down to 4.5V.

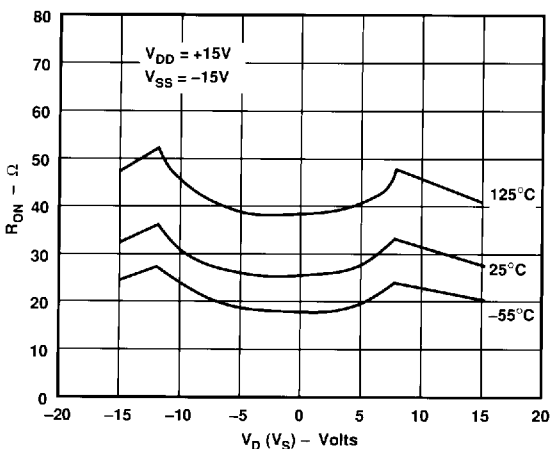

$R_{ON}$  as a Function of  $V_D$  ( $V_S$ ): Dual Supply Voltage

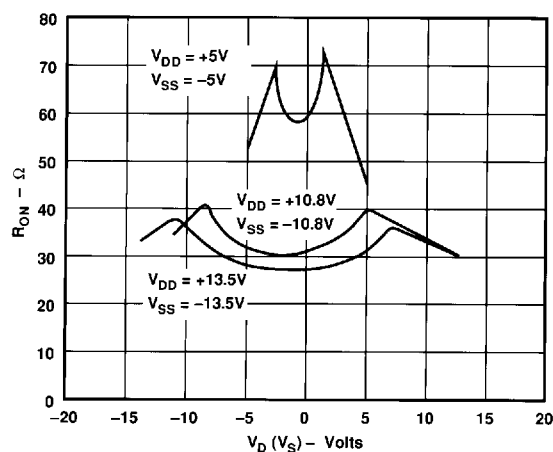

$R_{ON}$  as a Function of  $V_D$  ( $V_S$ ): Dual Supply Voltage,  $T_A = +25^\circ\text{C}$

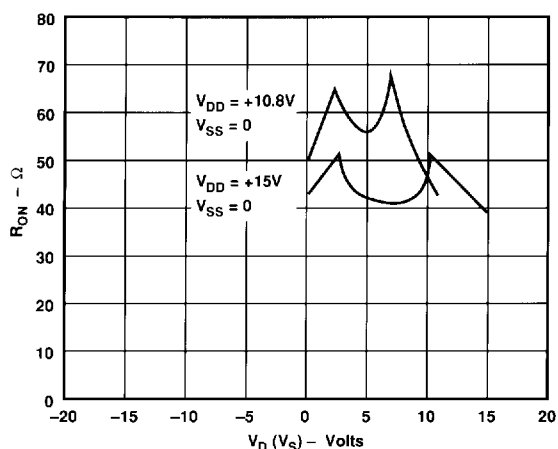

$R_{ON}$  as a Function of  $V_D$  ( $V_S$ ): Single Supply Voltage,  $T_A = +25^\circ\text{C}$

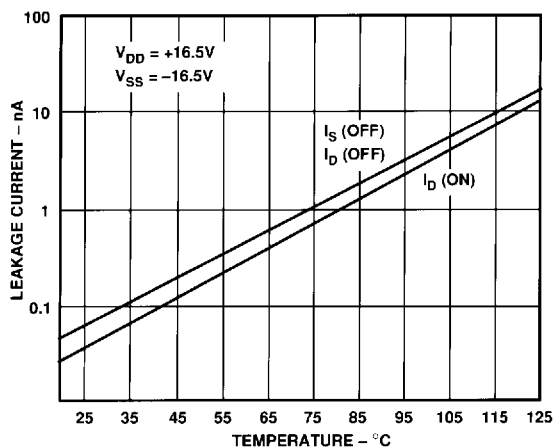

Leakage Current as a Function of Temperature Dual Supply Voltage. (Note: Leakage Currents Reduce as the Supply Voltages Reduce)

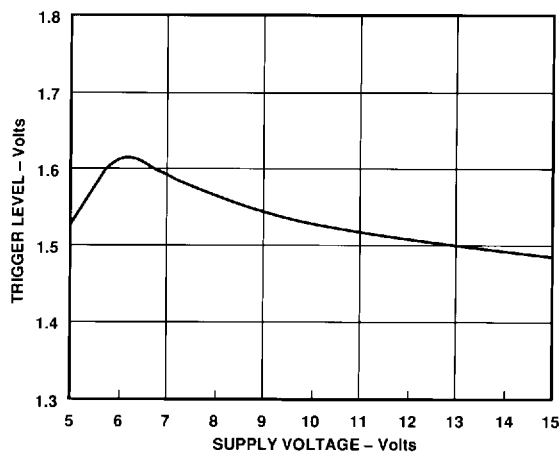

Trigger Levels vs. Power Supply Voltage, Dual or Single Supply,  $T_A = +25^\circ\text{C}$

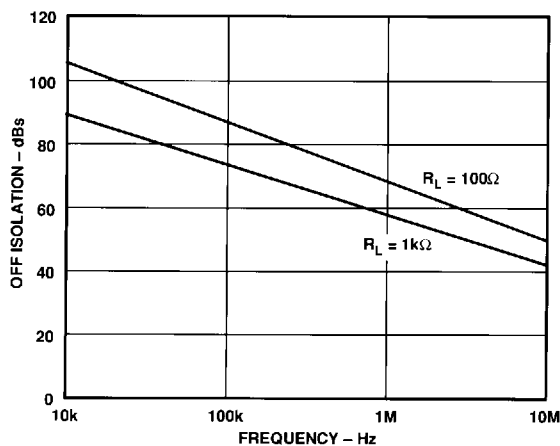

Off Isolation vs. Signal Frequency; Dual or Single 15V Supplies,  $T_A = +25^\circ\text{C}$

# ADG201HS—Typical Performance Characteristics (Continued)

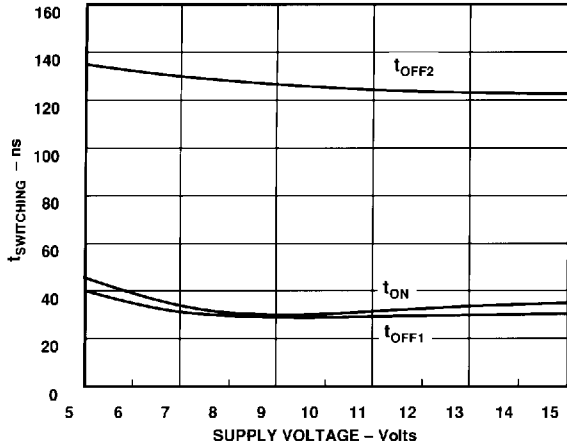

Switching Time vs. Supply Voltage (Dual Supply):  
 $T_A = +25^\circ\text{C}$ . (Note: See Test Circuit 4.  
 For  $V_{DD} < 10\text{V}$ ,  $V_S = V_{DD}$ )

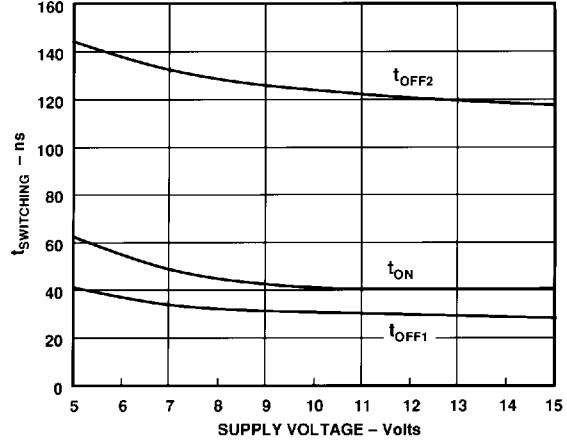

Switching Time vs. Supply Voltage (Single Supply):  
 $T_A = +25^\circ\text{C}$ . (Note: See Test Circuit 4.  
 For  $V_{DD} < 10\text{V}$ ,  $V_S = V_{DD}$ )

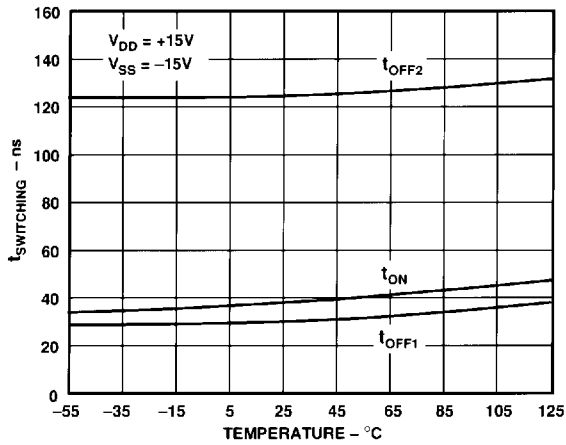

Switching Time vs. Temperature: Dual Supply Voltage

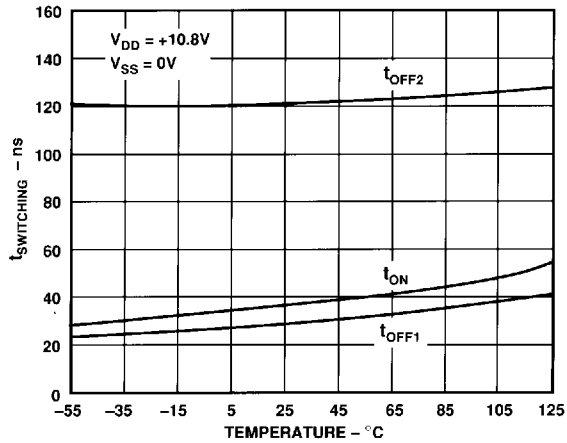

Switching Time vs. Temperature: Single Supply Voltage

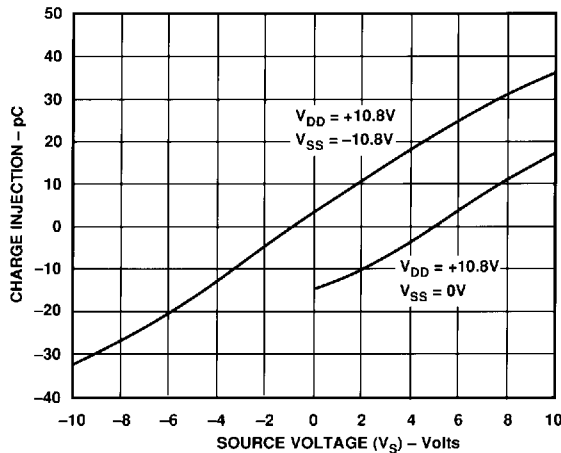

Charge Injection vs. Source Voltage ( $V_S$ ) for Dual and Single 10.8V Supplies:  $T_A = +25^\circ\text{C}$

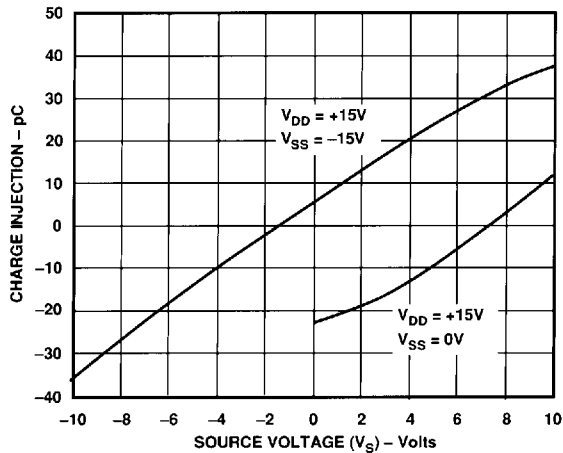

Charge Injection vs. Source Voltage ( $V_S$ ) for Dual and Single 15V Supplies:  $T_A = +25^\circ\text{C}$

# Test Circuits—ADG201HS

Note: All digital input signal rise and fall times measured from 10% to 90% of 3V.  $t_R = t_F = 5\text{ns}$ . Decoupling capacitors ( $0.01\mu\text{F}$  min) from  $V_{DD}$  and  $V_{SS}$  to GND are recommended to achieve specified performance.

**TEST CIRCUIT 1**  
 **$R_{ON}$**

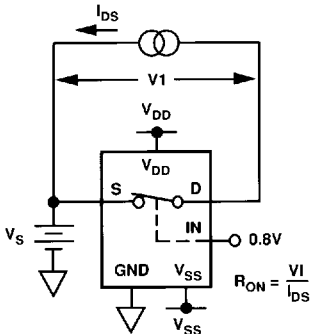

**TEST CIRCUIT 2**  
 **$I_S(\text{OFF}), I_D(\text{OFF})$**

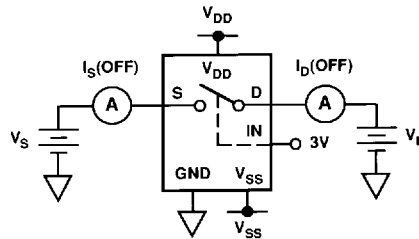

**TEST CIRCUIT 3**  
 **$I_D(\text{ON})$**

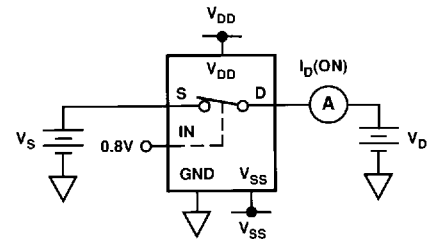

**TEST CIRCUIT 4**  
 **$t_{ON}, t_{OFF}, t_{OPEN}, \text{SETTLING TIME}$**

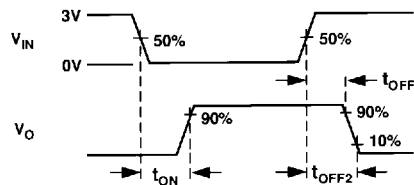
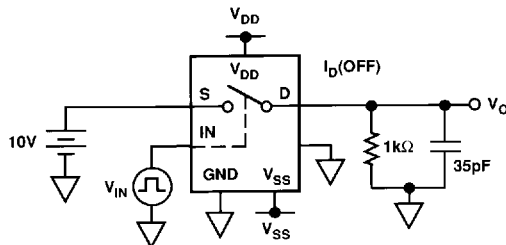

**TEST CIRCUIT 5**  
**OFF ISOLATION**

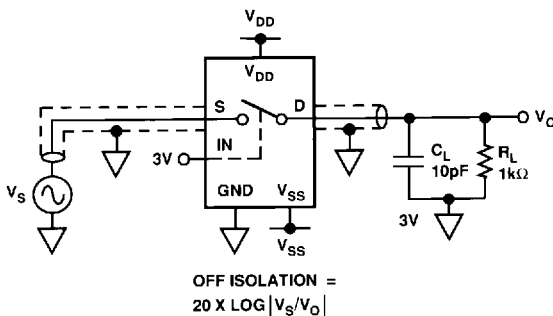

$$\text{OFF ISOLATION} = 20 \times \text{LOG} |V_S/V_O|$$

**TEST CIRCUIT 6**  
**CHANNEL-TO-CHANNEL CROSSTALK**

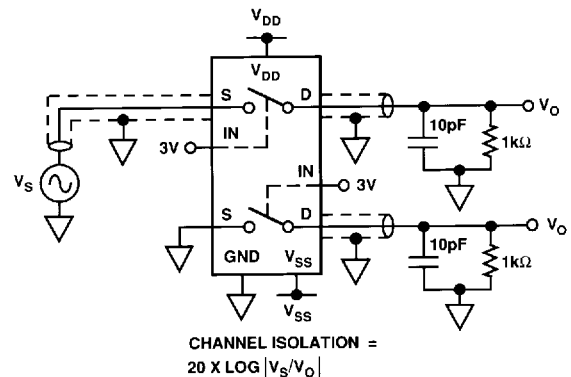

$$\text{CHANNEL ISOLATION} = 20 \times \text{LOG} |V_S/V_O|$$

**TEST CIRCUIT 7**  
**CHARGE INJECTION**

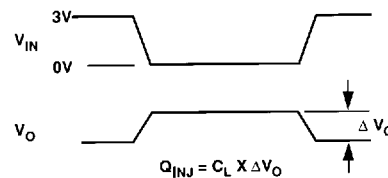
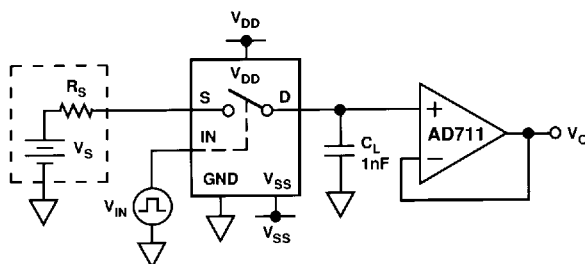

# ADG201HS

## SINGLE SUPPLY DISK DRIVE APPLICATION

The excellent performance of the ADG201HS with single supply operation makes it suitable in applications such as disk drives where only positive power supply voltages are normally available. The accompanying circuit shows a typical application for the ADG201HS in the read/write head switching section of a disk drive. The circuit allows data (0s and 1s) to be written to and read from a disk. The principal advantage offered by the ADG201HS is that it retains very fast switching speed with single supply operation (see Single Supply Specifications). This allows disk drives to run at higher data rates.

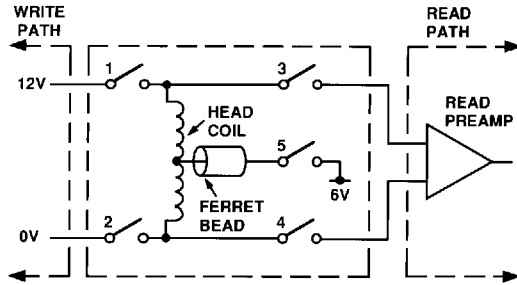

SWITCHES 1 TO 5 ALL ADG201HS

SWITCH NUMBER	WRITE		READ
	"0"	"1"	
1	OFF	ON	OFF
2	ON	OFF	OFF
3	OFF	OFF	ON
4	OFF	OFF	ON
5	ON	ON	OFF

ADG201HS in the Read/Write Head Switching Circuit of a Disk Drive

## OUTLINE DIMENSIONS

Dimensions shown in inches and (mm).

### 20-Terminal Plastic Leaded Chip Carrier (P-20A)

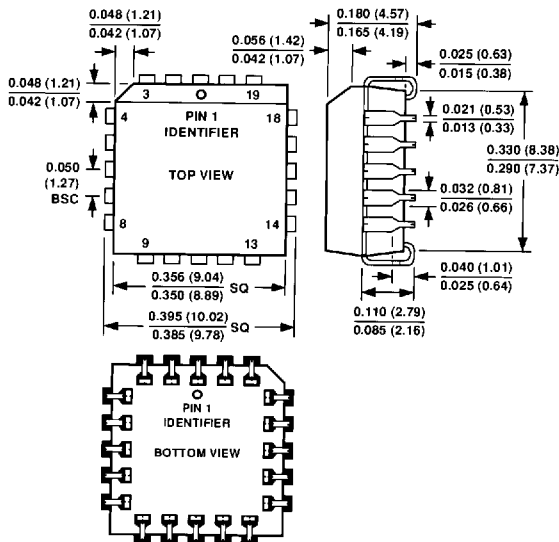

### 16-Pin Plastic DIP (N-16)

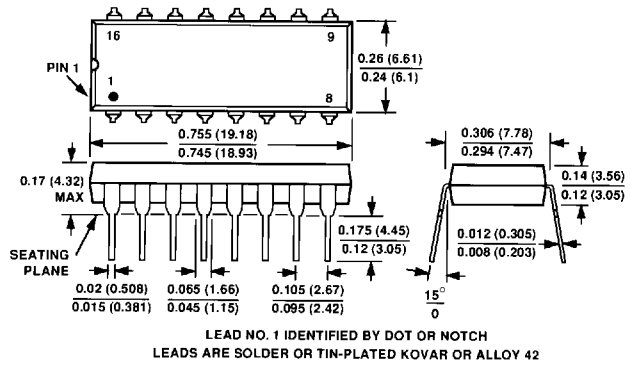

### 16-Pin Cerdip (Q-16)

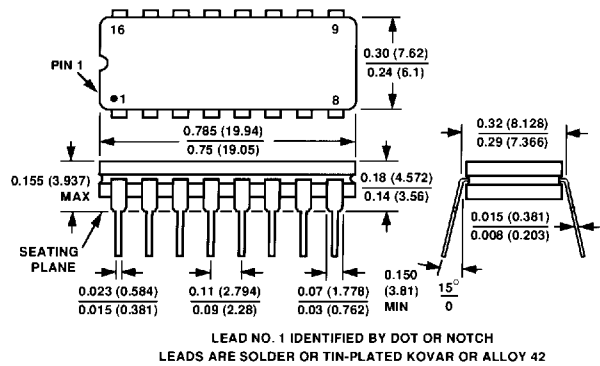

### 16-Lead Narrow Body SOIC (R-16A)

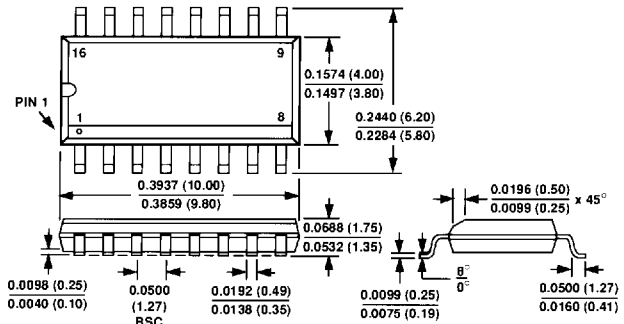

### 20-Terminal Leadless Ceramic Chip Carrier (E-20A)

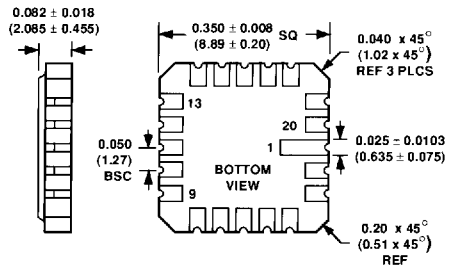

C1178-10-4 RR

PRINTED IN U.S.A.



Компания «Океан Электроники» предлагает заключение долгосрочных отношений при поставках импортных электронных компонентов на взаимовыгодных условиях!

Наши преимущества:

- Поставка оригинальных импортных электронных компонентов напрямую с производств Америки, Европы и Азии, а так же с крупнейших складов мира;
- Широкая линейка поставок активных и пассивных импортных электронных компонентов (более 30 млн. наименований);
- Поставка сложных, дефицитных, либо снятых с производства позиций;
- Оперативные сроки поставки под заказ (от 5 рабочих дней);
- Экспресс доставка в любую точку России;
- Помощь Конструкторского Отдела и консультации квалифицированных инженеров;
- Техническая поддержка проекта, помощь в подборе аналогов, поставка прототипов;
- Поставка электронных компонентов под контролем ВП;
- Система менеджмента качества сертифицирована по Международному стандарту ISO 9001;
- При необходимости вся продукция военного и аэрокосмического назначения проходит испытания и сертификацию в лаборатории (по согласованию с заказчиком);
- Поставка специализированных компонентов военного и аэрокосмического уровня качества (Xilinx, Altera, Analog Devices, Intersil, Interpoint, Microsemi, Actel, Aeroflex, Peregrine, VPT, Syfer, Eurofarad, Texas Instruments, MS Kennedy, Miteq, Cobham, E2V, MA-COM, Hittite, Mini-Circuits, General Dynamics и др.);

Компания «Океан Электроники» является официальным дистрибьютором и эксклюзивным представителем в России одного из крупнейших производителей разъемов военного и аэрокосмического назначения «JONHON», а так же официальным дистрибьютором и эксклюзивным представителем в России производителя высокотехнологичных и надежных решений для передачи СВЧ сигналов «FORSTAR».



## JONHON

«JONHON» (основан в 1970 г.)

Разъемы специального, военного и аэрокосмического назначения:

(Применяются в военной, авиационной, аэрокосмической, морской, железнодорожной, горно- и нефтедобывающей отраслях промышленности)

«FORSTAR» (основан в 1998 г.)

ВЧ соединители, коаксиальные кабели, кабельные сборки и микроволновые компоненты:

(Применяются в телекоммуникациях гражданского и специального назначения, в средствах связи, РЛС, а так же военной, авиационной и аэрокосмической отраслях промышленности).



Телефон: 8 (812) 309-75-97 (многоканальный)

Факс: 8 (812) 320-03-32

Электронная почта: [ocean@oceanchips.ru](mailto:ocean@oceanchips.ru)

Web: <http://oceanchips.ru/>

Адрес: 198099, г. Санкт-Петербург, ул. Калинина, д. 2, корп. 4, лит. А