

REFERENCE SPECIFICATIONS

-NFC 93425 (in compliance with HE 507)

PHYSICAL CHARACTERISTICS

- INSULATOR MATERIAL: THERMOPLASTIC UL94V0
- CONTACT MATERIAL: BRASS
- ACCESSORIES: BRASS
- SHELLS: STEEL

ELECTRICAL CHARACTERISTICS

- NOMINAL CURRENT: 30A or 40A
- CONTACT RESISTANCE: 7.3 m ohms
- CONTACT/CONTACT : 1000 V
- CONTACT/GROUND : 1200 V
- INSULATION RESISTANCE: 5000 MOhms

ENVIRONMENTAL CHARACTERISTICS

- CLIMATIC CATEGORY: 55/125/21
- TEMPERATURE RANGE -55°C TO +125°C
- DAMP HEAT STEADY STATE 21 DAYS
- SALT SPRAY 24 HOURS

MECHANICAL CHARACTERISTICS

- RETENTION AGAINST TORQUE: - Threaded insert: 0.7 N.m minimum
- Female screw : 0.5 N.m minimum

NOTE RoHS INFORMATION

- The "LF" products meet european union Directives and other country regulations as described in GS-22-008.
- The housing will withstand exposure to 260°C peak temperature for 3.5 seconds in a wave solder application with a 1.6mm minimum thick circuit board. See application notes/procedures if they are available.
- Termination plating spec:
 - Ni 1.27µm+Sn 2.5 to 7.5µ(pure bright)
- Active area plating spec:
 - Ni + Gold
- Shell plating :2 to 4µm Cu + 3 to 10µmm Sn(pure bright)
- Accessories: Sn pure bright
- Packaging spec: See GS-14-920

DBL5W5P300G30LF

Series

Shell size: **E A B C**
see sheet 2

Front accessory definition
see sheet 2

- L** : threaded insert M3
- O** : threaded insert UNC 4-40
- V** : female screw UNC 4-40
- I** : female screw M3

Layout of contacts (see sheet 3)

Contacts

P : Pin

Termination type

3 Straight version

Plating

- 00** 200 matings/unmatings
- 43** 500 matings/unmatings

PCB accessories definition
see sheet 2

- H** : harpoons for PCB 2.40mm
- G** : harpoons for PCB 1.60mm

Power contacts

- 00** : Not fitted with power contact (signal contacts always fitted)
- 30** : Fitted with power contacts 30 Amp.
- 40** : Fitted with power contacts 40 Amp.

See note RoHS

TABLE 1:PCB HOLE DIAMETERS

POWER CONTACTS			ACCESSORIES
30 A	2.00	ø2.40	ø3.10
40 A	2.80	3.10	
Max current power	øA +0.1 0	PCB HOLE +/-0.1	PCB HOLE +/-0.1



www.fciconnect.com		surface ISO 1302	tolerance std ISO 406 ISO 1101	projection	mm
TOLERANCES UNLESS OTHERWISE SPECIFIED		ANGULAR 0.X ±0.3	LINEAR 0.XX ±0.1	size A2	Scale 2:1
Dr M PESSON 2005-10-11	Eng P LEGARE 2005-10-11	Chr	Appr	ECN F09-0092	Spec ref

rev	ecn no	dr	date	title	part no	Rev.
A	LS05-0113	MPE	2005-10-11	SUB MALE DW	C01-8639-2314	G
B	LS06-0208	LGO	2006-12-13	full power straight solder		
C	LS07-0165	MPE	2007/06/14			
D	LS07-0213	MPE	2007/11/05			
E	LS09-0027	MPE	2009/01/21			
F	F09-0063	LSA	2009-07-15			
G	F09-0092	LSA	2009-09-26			

Copyright FCI. FCI



FRONT ACCESSORY	L insert M3 O insert UNC 4.40	V Female screw UNC 4.40 I Female screw M3	L insert M3 O insert UNC 4.40	V Female screw UNC 4.40 I Female screw M3
PCB ACCESSORIES	G Harpoon for PCB 1.60mm	G Harpoon for PCB 1.60mm	H Harpoon for PCB 2.40mm	H Harpoon for PCB 2.40mm

PART NUMBER	AMPS	MATINGS/ UNMATINGS	FRONT ACCESSORY	PCB ACCESSORIES
D*LxWxP300G30LF	30	200	insert M3	harpoon PCB 1.60mm
D*OxWxP300G30LF	30	200	insert UNC 4.40	harpoon PCB 1.60mm
D*VxWxP300G30LF	30	200	female screw UNC 4.40	harpoon PCB 1.60mm
D*IxWxP300G30LF	30	200	female screw M3	harpoon PCB 1.60mm
D*LxWxP300H30LF	30	200	insert M3	harpoon PCB 2.40mm
D*OxWxP300H30LF	30	200	insert UNC 4.40	harpoon PCB 2.40mm
D*VxWxP300H30LF	30	200	female screw UNC 4.40	harpoon PCB 2.40mm
D*IxWxP300H30LF	30	200	female screw M3	harpoon PCB 2.40mm
D*LxWxP300G40LF	40	200	insert M3	harpoon PCB 1.60mm
D*OxWxP300G40LF	40	200	insert UNC 4.40	harpoon PCB 1.60mm
D*VxWxP300G40LF	40	200	female screw UNC 4.40	harpoon PCB 1.60mm
D*IxWxP300G40LF	40	200	female screw M3	harpoon PCB 1.60mm
D*LxWxP300H40LF	40	200	insert M3	harpoon PCB 2.40mm
D*OxWxP300H40LF	40	200	insert UNC 4.40	harpoon PCB 2.40mm
D*VxWxP300H40LF	40	200	female screw UNC 4.40	harpoon PCB 2.40mm
D*IxWxP300H40LF	40	200	female screw M3	harpoon PCB 2.40mm

shell size *
 E 2V2
 A 3V3
 A 3W3
 B 5W5
 C 8W8

PART NUMBER	AMPS	MATINGS/ UNMATINGS	FRONT ACCESSORY	PCB ACCESSORIES
D*LxWxP343G30LF	30	500	insert M3	harpoon PCB 1.60mm
D*OxWxP343G30LF	30	500	insert UNC 4.40	harpoon PCB 1.60mm
D*VxWxP343G30LF	30	500	female screw UNC 4.40	harpoon PCB 1.60mm
D*IxWxP343G30LF	30	500	female screw M3	harpoon PCB 1.60mm
D*LxWxP343H30LF	30	500	insert M3	harpoon PCB 2.40mm
D*OxWxP343H30LF	30	500	insert UNC 4.40	harpoon PCB 2.40mm
D*VxWxP343H30LF	30	500	female screw UNC 4.40	harpoon PCB 2.40mm
D*IxWxP343H30LF	30	500	female screw M3	harpoon PCB 2.40mm
D*LxWxP343G40LF	40	500	insert M3	harpoon PCB 1.60mm
D*OxWxP343G40LF	40	500	insert UNC 4.40	harpoon PCB 1.60mm
D*VxWxP343G40LF	40	500	female screw UNC 4.40	harpoon PCB 1.60mm
D*IxWxP343G40LF	40	500	female screw M3	harpoon PCB 1.60mm
D*LxWxP343H40LF	40	500	insert M3	harpoon PCB 2.40mm
D*OxWxP343H40LF	40	500	insert UNC 4.40	harpoon PCB 2.40mm
D*VxWxP343H40LF	40	500	female screw UNC 4.40	harpoon PCB 2.40mm
D*IxWxP343H40LF	40	500	female screw M3	harpoon PCB 2.40mm

Copyright FCI.
FCI

www.fciconnect.com		surface - ISO 1302	tolerance std ISO 406 ISO 1101	projection	mm
TOLERANCES UNLESS OTHERWISE SPECIFIED					
Dr	M PESSON	2005-10-11	ANGULAR	0.X ±0.3	size A2
Eng	P LEGARE	2005-10-11	LINEAR	0.XXX ±0.1	Scale 2:1
Chr			0° ±2°	0.05	ECN F09-0092
Appr			Product family		Spec ref

SCALE: 4

FCI	TITLE SUB MALE DW	eng no C01-8639-2314	Rev. G
	full power straight solder		

2V2

LAYOUT AND CONNECTOR DIMENSIONS
For PCB hole diameters see table 1 sheet 1



3V3

LAYOUT AND CONNECTOR DIMENSIONS
For PCB hole diameters see table 1 sheet 1



3W3

LAYOUT AND CONNECTOR DIMENSIONS
For PCB hole diameters see table 1 sheet 1



SIDE VIEW FOR
LAYOUTS: E A B C



Cote "A"

30A	3.1 ± 0.25
40A	3.6 ± 0.25

Copyright FCI.
FCI

www.fciconnect.com		surface - ISO 1302	tolerance std ISO 406 ISO 1101	projection	mm
		TOLERANCES UNLESS OTHERWISE SPECIFIED			
Dr	M PESSON	2005-10-11	ANGULAR	0.X ± 0.3	size A2
Eng	P LEGARE	2005-10-11	LINEAR	0.XX ± 0.1	Scale 2:1
Chr			0° ± 2°	0.XXX ± 0.05	ECN F09-0092
Appr			Product family		Spec ref

FCI	TITLE SUB MALE DW	part no C01-8639-2314	Rev. G
	full power straight solder		

5W5

LAYOUT AND CONNECTOR DIMENSIONS

For PCB hole diameters see table 1 sheet 1



8W8

LAYOUT AND CONNECTOR DIMENSIONS

For PCB hole diameters see table 1 sheet 1

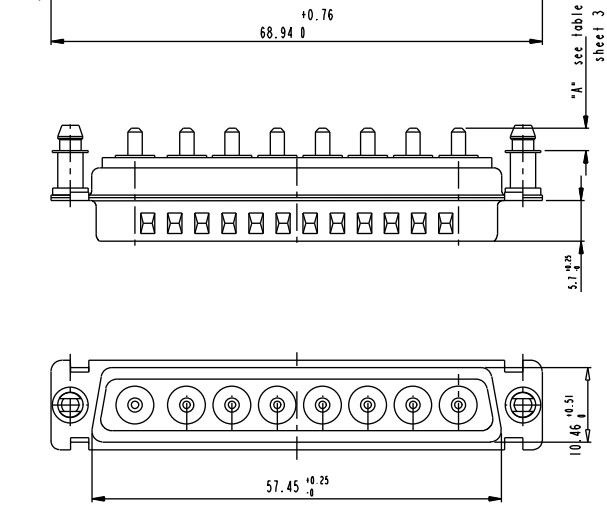
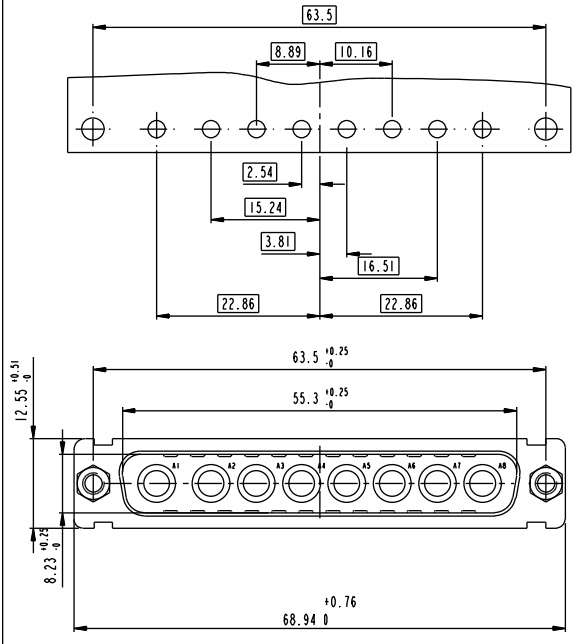

www.fciconnect.com		surface ISO 1302	tolerance std ISO 406 ISO 1101	projection mm
TOLERANCES UNLESS OTHERWISE SPECIFIED				
Dr	M PESSON	2005-10-11	ANGULAR	size A2
Eng	P LEGARE	2005-10-11	LINEAR	Scale 2:1
Chr			0° ±2°	ECN F09-0092
Appr			Product family	Spec ref

FCI	TITLE SUB MALE DW full power straight solder	part no C01-8639-2314	Rev. G
------------	--	--------------------------	-----------

Компания «Океан Электроники» предлагает заключение долгосрочных отношений при поставках импортных электронных компонентов на взаимовыгодных условиях!

Наши преимущества:

- Поставка оригинальных импортных электронных компонентов напрямую с производств Америки, Европы и Азии, а так же с крупнейших складов мира;
- Широкая линейка поставок активных и пассивных импортных электронных компонентов (более 30 млн. наименований);
- Поставка сложных, дефицитных, либо снятых с производства позиций;
- Оперативные сроки поставки под заказ (от 5 рабочих дней);
- Экспресс доставка в любую точку России;
- Помощь Конструкторского Отдела и консультации квалифицированных инженеров;
- Техническая поддержка проекта, помощь в подборе аналогов, поставка прототипов;
- Поставка электронных компонентов под контролем ВП;
- Система менеджмента качества сертифицирована по Международному стандарту ISO 9001;
- При необходимости вся продукция военного и аэрокосмического назначения проходит испытания и сертификацию в лаборатории (по согласованию с заказчиком);
- Поставка специализированных компонентов военного и аэрокосмического уровня качества (Xilinx, Altera, Analog Devices, Intersil, Interpoint, Microsemi, Actel, Aeroflex, Peregrine, VPT, Syfer, Eurofarad, Texas Instruments, MS Kennedy, Miteq, Cobham, E2V, MA-COM, Hittite, Mini-Circuits, General Dynamics и др.);

Компания «Океан Электроники» является официальным дистрибьютором и эксклюзивным представителем в России одного из крупнейших производителей разъемов военного и аэрокосмического назначения «**JONHON**», а так же официальным дистрибьютором и эксклюзивным представителем в России производителя высокотехнологичных и надежных решений для передачи СВЧ сигналов «**FORSTAR**».



JONHON

«**JONHON**» (основан в 1970 г.)

Разъемы специального, военного и аэрокосмического назначения:

(Применяются в военной, авиационной, аэрокосмической, морской, железнодорожной, горно- и нефтедобывающей отраслях промышленности)

«**FORSTAR**» (основан в 1998 г.)

ВЧ соединители, коаксиальные кабели,
кабельные сборки и микроволновые компоненты:

(Применяются в телекоммуникациях гражданского и специального назначения, в средствах связи, РЛС, а так же военной, авиационной и аэрокосмической отраслях промышленности).



Телефон: 8 (812) 309-75-97 (многоканальный)

Факс: 8 (812) 320-03-32

Электронная почта: ocean@oceanchips.ru

Web: <http://oceanchips.ru/>

Адрес: 198099, г. Санкт-Петербург, ул. Калинина, д. 2, корп. 4, лит. А