



EVE2 TFT Module

Hardware Manual

Revision 1.3

Revision History

| Revision | Date | Description | Author |
|----------|---------------------------------|---|--------|
| 1.3 | March 6, 2018 | Added Backlight circuitry and Parallel TFT information | Divino |
| 1.2 | October 23 rd , 2017 | Corrected bezel information in section 2.1. Added additional header information | Divino |
| 1.1 | October 10 th , 2017 | Added link to FTDI/Bridgetek Programmers Guide | Divino |
| 1.0 | August 3 rd , 2017 | Initial Release | Divino |

Contents

- Revision History 1
- 1. Introduction 1
 - 1.1. Key Features 1
 - 1.2. Block Diagram 1
- 2. FTDI/Bridgetek EVE Chip 2
 - 2.1. FTDI/Bridgetek EVE Graphics Engine 2
- 3. EVE2 Headers 3
 - 3.1. Communication Header Pinout 3
- 4. Communication Model 4
 - 4.1. Programming Model 4
 - 4.2. General Software Architecture 4
- 5. Communication Interface 4
 - 5.1. SPI Interface Timing Specification 4
 - 5.2. SPI and QSPI communication 5
 - 5.3. Serial Data Protocol 6
- 6. Peripherals 7
 - 6.1. Audio Engine 7
 - 6.2. Sound Synthesizer 7
 - 6.3. Audio Playback 8
 - 6.4. General Purpose Input Output 9
- 7. Backlight 9
 - 7.1. Backlight Driver 9
- 8. TFT Display 9
 - 8.1. EVE2 Module Displays 9
 - 8.2. EVE2 TFT Display Timings 10
- 9. Electrical Characteristics 10
 - 9.1. Absolute Maximum Ratings 10
 - 9.2. EVE2 DC Characteristics 10
 - 9.3. EVE2 Digital I/O Pin Characteristics 10
 - 9.4. Power Specifications 11
 - 9.5. Touch Sense Characteristics 11
- 10. Mounting 11
 - 10.1. Extended Capacitive Touch 11
- 11. Ordering Options 11
 - 11.1. Matrix Orbital EVE2 series displays 11
 - 11.2. Matrix Orbital Product Line Comparison 12
 - 11.3. Software Support 12
- 12. Dimensional Drawing 13
- 13. EVE2 TFT Module Schematic 14
- 14. Contact 14

1. Introduction

The Matrix Orbital EVE2 lineup utilizes FTDI/Bridgetek’s second generation Embedded Video Engine to control, render, manage and display complex graphics on a full color TFT touch screen. By taking advantage of the 1 megabyte of graphics RAM, motion-JPEG encoded AVI videos can be played back in both portrait and landscape mode. Data can be displayed through a set of widgets such as gauges, spinners, sliders, and bar graphs.

Additional features include added touch control hardware, capable of recognizing and tracking touch movement and providing notification for up to 255 touch objects. Mono 8-bit linear audio wave playback at sampling frequencies from 8 kHz to 48 kHz is made possible by the built-in sound synthesizer and digital filter.

The EVE2 communicates using SPI protocol, and can be configured for quad SPI communication. Using SPI communication protocol makes the EVE2 compatible with many microcontrollers available on the market, including the FTDI/Bridgetek FT900, NXP 17XX, Arduino, and many more. With built-in graphics operations, and support for multiple widgets, development of high-quality Human Machine Interfaces (HMI) screens is simplified.

1.1. Key Features

- Advanced Embedded Video Engine(EVE) with high resolution graphics and video playback
- Support multiple widgets for simplified design development
- Support for Resistive and Capacitive Touch Screen Technology
- Support capacitive touch screen with up to 5 touches detection
- Support for LCD display with resolution up to SVGA (800x600) and formats with data enable (DE) mode or VSYNC/HSYNC mode
- Support landscape and portrait orientations
- Support playback of motion-JPEG encoded AVI videos
- -20°C to 70°C extended operating temperature range

1.2. Block Diagram

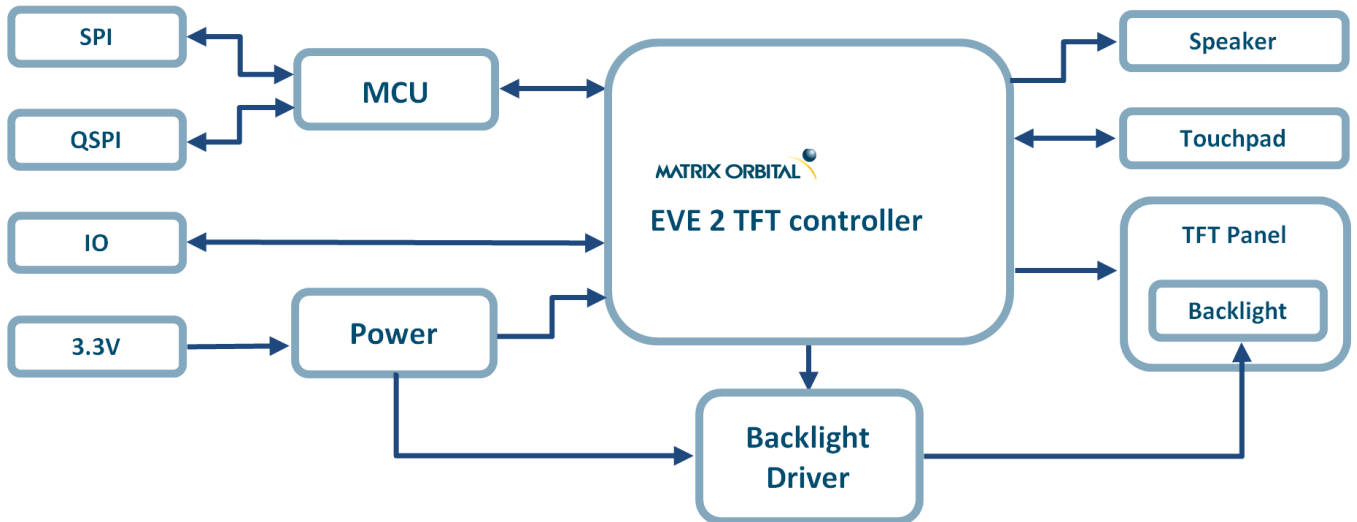

Figure 1: EVE2 TFT Module Block Diagram



2. FTDI/Bridgetek EVE Chip

FTDI/Bridgetek Chip develops innovative silicon solutions that enhance interaction with the latest in global technology. The major objective from the company is to ‘bridge technologies’ in order to support engineers with highly sophisticated, feature-rich, robust and simple-to-use product platforms. These platforms enable creation of electronic designs with high performance, low peripheral component requirements, low power budgets and minimal board real estate.

2.1. FTDI/Bridgetek EVE Graphics Engine

The FT81X series chips are graphics controllers with add-on features such as audio playback and touch capabilities. They consist of a rich set of graphics objects (primitive and widgets) that can be used for displaying various menus and screen shots for a range of products including home appliances, toys, industrial machinery, home automation, elevators, and many more.

EVE graphics controller ICs combine display, touch and audio functionality within a single chip and take an innovative object-oriented approach to HMI implementation that is proving highly effective. It leads to more streamlined solutions that are simpler to create, with significantly lower component counts, reduced board space requirements, curbed power consumption, etc. The second generation EVE devices at the heart of these new development modules have greater pixel resolution than the previous EVE ICs, resulting in sharper image rendering and greater colour depth. They also have accelerated data transfer and image/video loading capabilities, enhanced video playback, plus expanded memory resources.

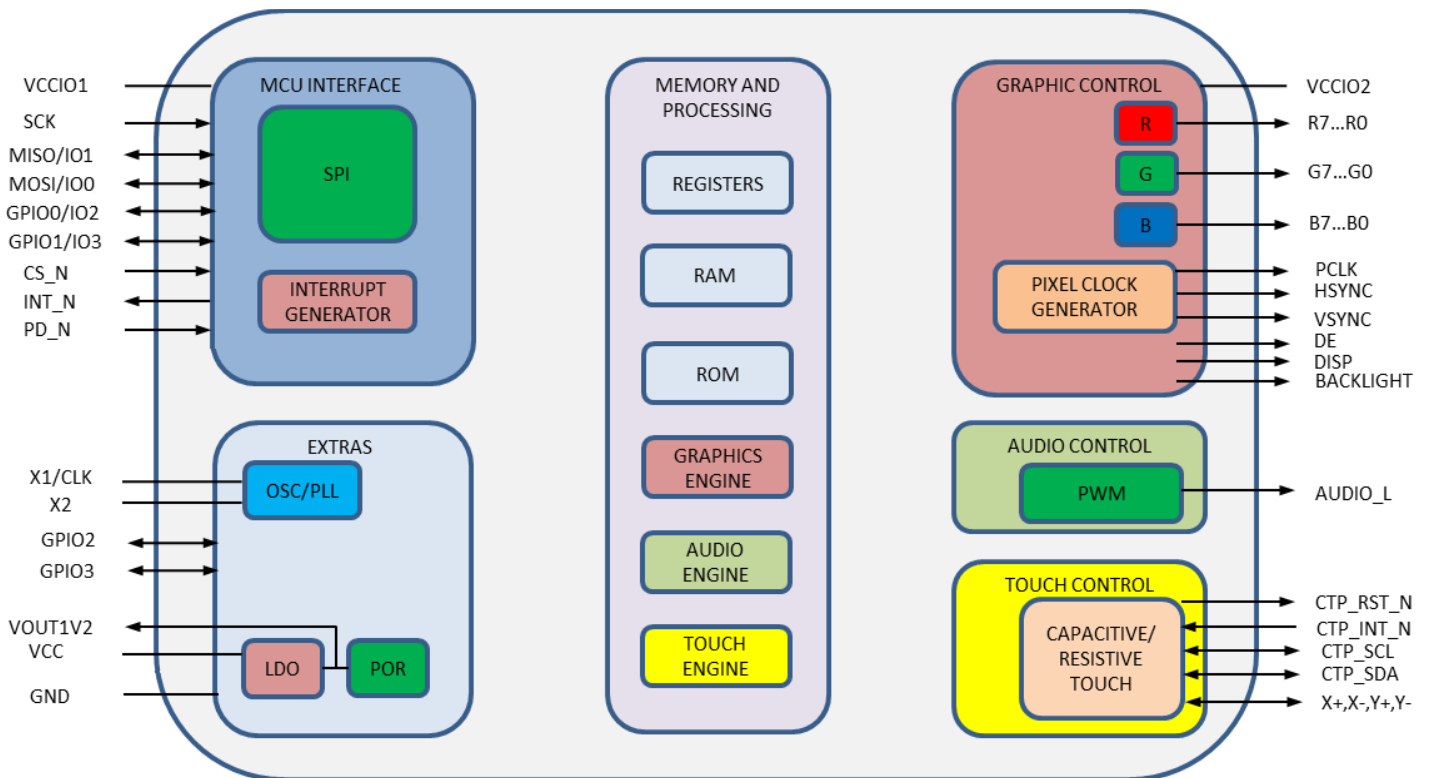

Figure 2: EVE2 Embedded Video Engine

More details regarding the EVE2 hardware specs can be found in the FTDI/Bridgetek FT81x Datasheet, available online. An FTDI/Bridgetek EVE2 programming guide, titled “FT81x Series Programming Guide”, is also available and can be downloaded at FTDI/Bridgetek’s website <http://www.brtchip.com/ft81x>



3. EVE2 Headers

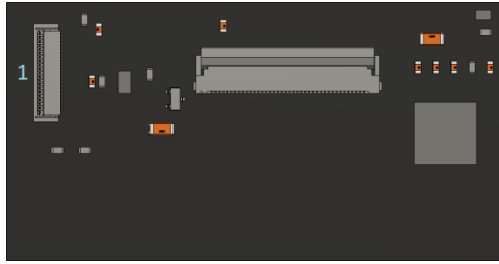

Figure 3: EVE2 Module Header Locations

Table 1: List of available Headers

| # | Header | Standard Mate |
|---|-----------------------------|---------------|
| 1 | SPI Communication and Power | FFC-20P |

3.1. Communication Header Pinout

The 20 pin FFC header on the EVE2 TFT Module is used to interface with an SPI controller, and is compatible with a number of 20 pin ribbon cables. Any 20 pin FFC cable with a 0.5mm pitch and bottom contacts, such as the Würth Electronics INC 687620050002 series ribbon cable will be compatible with the EVE2 module.

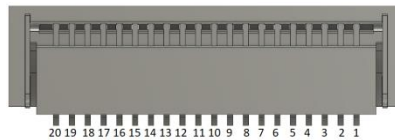

Figure 4: 20 pin FFC communication header

Table 2: 20 pin FFC communication header pinout

| Pin | Symbol | Type | Function |
|-----|-------------------------|-------------------|--|
| 1 | VCC | Power | Logic Voltage (3.3V) |
| 2 | GND | Ground | Ground Connection |
| 3 | SCK | Input | SPI clock input |
| 4 | MISO | Input/output | SPI Single mode: SPI MISO output SPI Dual/Quad mode: SPI data line 1 |
| 5 | MOSI | Input/output | SPI Single mode: SPI MISO input SPI Dual/Quad mode: SPI data line 0 |
| 6 | CS | Input | SPI slave select input.* |
| 7 | $\overline{\text{INT}}$ | Open Drain Output | Interrupt to host** |
| 8 | RST | | FT81x Reset pin |
| 9 | N/C | No connection | No connection |
| 10 | AUDIO | Output | Audio PWM out |
| 11 | IO2 | Input/output | SPI Single/Dual mode: General purpose IO 0 SPI Quad mode: SPI data line 2 |
| 12 | IO3 | Input/output | SPI Single/Dual mode: General purpose IO 1 SPI Quad mode: SPI data line 3 |
| 13 | GPIO2 | Input/output | General purpose IO 2 |
| 14 | GPIO3 | Input/output | General purpose IO 3 |
| 15 | GND | Ground | Ground connection |
| 16 | VCC | Power | Logic Voltage (3.3V) |
| 17 | BLVDD | VDD | No Connect (Optional Backlight Voltage) |
| 18 | BLVDD | VDD | No Connect (Optional Backlight Voltage) |
| 19 | BLGND | Ground | Ground |
| 20 | BLGND | Ground | Ground |

*Note: The CS pin signifies when a SPI transaction occurs by going active low. When the pin goes inactive high, the write operation is considered complete.

**Note: Open drain output (default) or push-pull output, active low



4. Communication Model

4.1. Programming Model

The FT81X appears to the host MCU as a memory-mapped SPI device. The host MCU sends commands and data over the serial protocol described in the data sheet.

4.2. General Software Architecture

The software architecture can be broadly classified into layers such as custom applications, graphics/GUI manager, video manger, audio manager, drivers etc. FT81X higher level graphics engine commands and co-processor engine widget commands are part of the graphics/GUI manager. Control & data paths of video and audio are part of video manager and audio manager. Communication between graphics/GUI manager and the hardware is via the SPI driver. Typically the display screen shot is constructed by the custom application based on the framework exposed by the graphics/GUI manager.

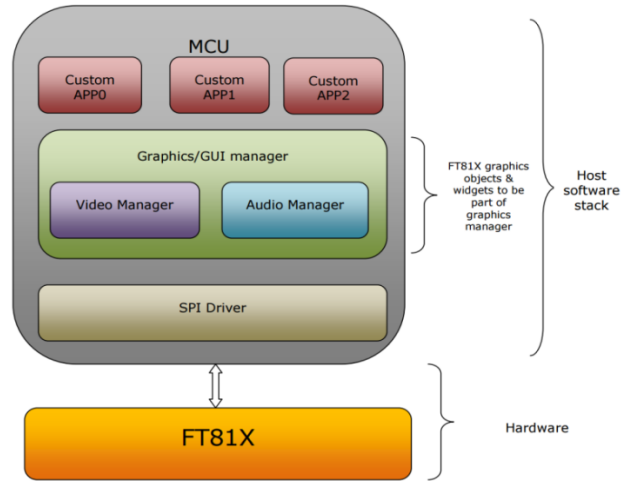

Figure 5: EVE2 Programmer model

5. Communication Interface

5.1. SPI Interface Timing Specification

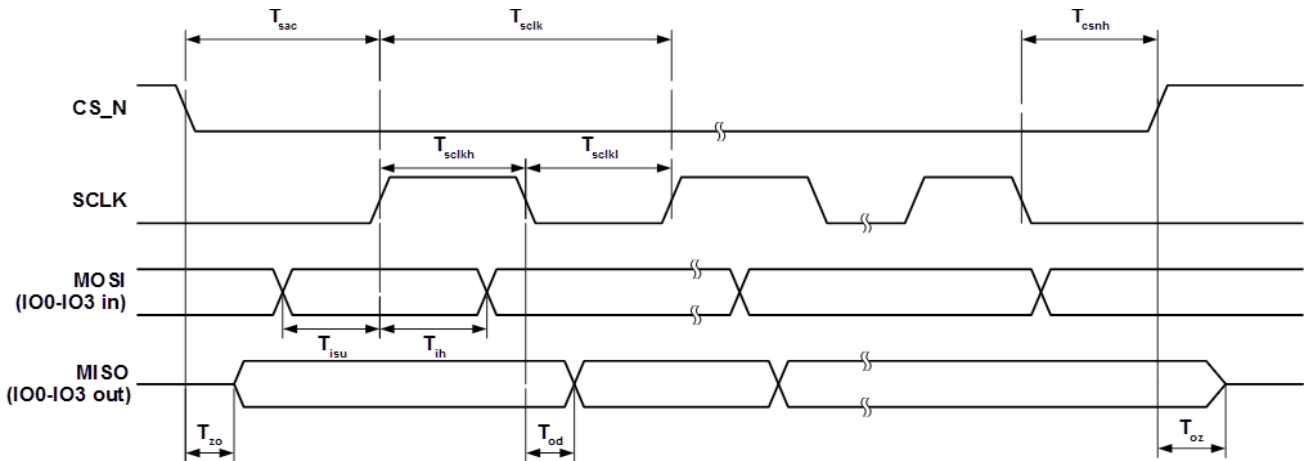

Figure 6: SPI Timing Diagram

Table 3: SPI Timing Signals

| Parameter | Description | VCCIO = 3.3V | | Units |
|-----------|-------------------------------------|--------------|-----|-------|
| | | Min | Max | |
| Tsclk | SPI Clock Period (SINGLE/DUAL mode) | 33.3 | | ns |
| Tsclk | SPI clock Period (QUAD mode) | 40 | | ns |
| Tsckl | SPI clock low duration | 13 | | ns |
| Tsckh | SPI clock high duration | 13 | | ns |
| Tsac | SPI access time | 3 | | ns |
| Tisu | Input Setup | 3 | | ns |
| Tih | Input hold | 0 | | ns |
| Tzo | Output enable delay | | 11 | ns |
| Toz | Output disable delay | | 10 | ns |
| Tod | Output data delay | | 11 | ns |
| Tcsnh | CSN hold time | 0 | | ns |



5.2. SPI and QSPI communication

The EVE2 TFT Module is capable of communicating to hosts and microcontrollers through a quad serial parallel interface (QSPI). Only SPI mode 0 is supported. The QSPI slave interface can operate up to 30MHz, and can be configured in SINGLE, DUAL or QUAD channel modes.

The SPI slave defaults to SINGLE channel mode operation, using MISO as output to the master and MOSI as input from the master. The SPI slave can be configured to allow DUAL and QUAD channel modes by writing to register REG_SPI_WIDTH while in single channel mode.

Table 4: SPI/QSPI Communication Configuration

| REG_SPI_WIDTH[1:0] | Channel Mode | Data pins | Max bus speed |
|--------------------|-----------------------|--------------------|---------------|
| 00 | SINGLE - default mode | MISO, MOSI | 30 MHz |
| 01 | DUAL | IO0, IO1 | 30 MHz |
| 10 | QUAD | IO0, IO1, IO2, IO3 | 25 MHz |
| 11 | Reserved | - | - |

When DUAL/QUAD channel modes are enabled, the SPI data ports become unidirectional. SPI transactions will be signified by CS going active low when DUAL/QUAD modes are active, and data ports are set as inputs.

Hence, for writing to the FT81x, the protocol is “WR-Command/Addr2, Addr1, Addr0, DataX, DataY, DataZ ...” The write operation is considered complete when CS goes inactive high.

For reading from the FT81x, the protocol is “RD-Command/Addr2, Addr1, Addr0, Dummy-Byte, DataX, DataY, DataZ”. However as the data ports are now unidirectional, a change of port direction will occur before DataX is clocked out of the FT81x. Therefore it is important that the firmware controlling the SPI master changes the SPI master data port direction to “input” after transmitting Addr0. The FT81x will not change the port direction till it starts to clock out DataX. Hence, the Dummy-Byte cycles will be used as a change-over period when neither the SPI master nor slave will be driving the bus; the data paths thus must have pull-ups/pull-downs. The SPI slave from the FT81x will reset all its data ports’ direction to input once CS goes inactive high (i.e. at the end of the current SPI master transaction).

The below diagram depicts the behaviour of both the SPI master and slave in the master read case.

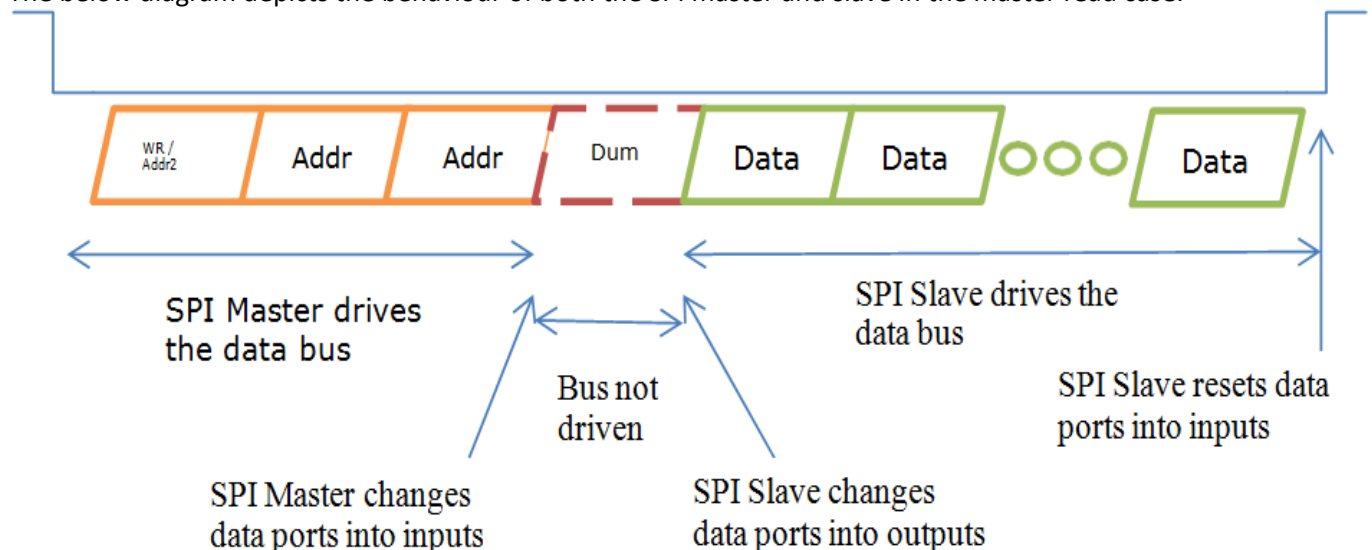

Figure 7: SPI Master and Slave bus behaviour



For DUAL channel operation, MISO(MSB) and MOSI are used. In Quad channel operation, IO3(MSB), IO2, MISO, and MOSI are used.

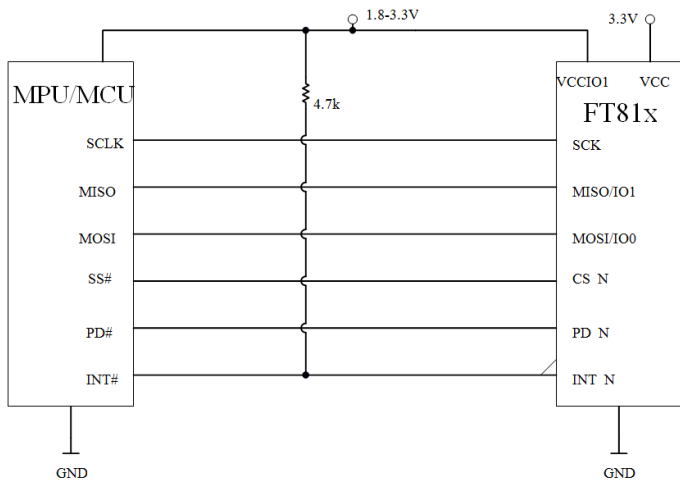

Figure 8: Single/Dual Channel SPI Interface connection

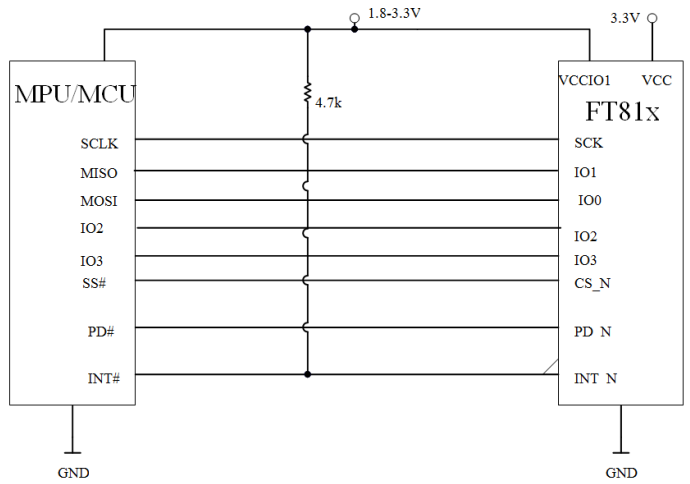

Figure 9: Quad channel SPI Interface connection

5.3. Serial Data Protocol

When interfaced with a host, the FT81x will appear as a memory-mapped SPI device. Communication between the host and the FT81x is accomplished through a series of reads and writes to a large (4 megabyte) address space. Within this address space are dedicated areas for graphics, audio and touch control.

The FT81x address space is read and written to using SPI transactions. Memory read, memory write and command write transactions are sent by the most significant bit first.

Each transaction starts with CS going low, and ends when CS going high. Data transactions have no limit regarding data length, so long as the memory address is continuous.

When initiating an SPI memory read transaction, the host will send two zero bits, followed by the 22-bit address. A dummy byte follows the address, and the FT81x will respond to each host byte with read data bytes.

Table 5: SPI Memory read transaction

| 7 | 6 | 5 | 4 | 3 | 2 | 1 | 0 | |
|---|---|-----------------|---|---|---|---|---|-----------------|
| 0 | 0 | Address [21:16] | | | | | | } Write Address |
| | | Address [15:8] | | | | | | |
| | | Address [7:0] | | | | | | |
| | | Dummy byte | | | | | | } Read Address |
| | | Byte 0 | | | | | | |
| | | Byte n | | | | | | |

For SPI memory write transactions, a '1' bit and '0' bit is sent by the host, followed by the 22-bit address. The write data follows.

Table 6: SPI Memory write transaction

| 7 | 6 | 5 | 4 | 3 | 2 | 1 | 0 | |
|---|---|-----------------|---|---|---|---|---|-----------------|
| 1 | 0 | Address [21:16] | | | | | | } Write Address |
| | | Address [15:8] | | | | | | |
| | | Address [7:0] | | | | | | |
| | | Dummy byte | | | | | | } Read Address |
| | | Byte 0 | | | | | | |
| | | Byte n | | | | | | |



6. Peripherals

6.1. Audio Engine

FT81x provides mono audio output through a PWM output pin, AUDIO_L. It outputs two audio sources, the sound synthesizer and audio file playback.

6.2. Sound Synthesizer

A sound processor, AUDIO ENGINE, generates the sound effects from a small ROM library of waves table. To play a sound effect listed in Table 4.3, load the REG_SOUND register with a code value and write 1 to the REG_PLAY register. The REG_PLAY register reads 1 while the effect is playing and returns a '0' when the effect ends. Some sound effects play continuously until interrupted or instructed to play the next sound effect. To interrupt an effect, write a new value to REG_SOUND and REG_PLAY registers; e.g. write 0 (Silence) to REG_SOUND and 1 to PEG_PLAY to stop the sound effect.

The sound volume is controlled by register REG_VOL_SOUND. The 16-bit REG_SOUND register takes an 8-bit sound in the low byte. For some sounds, marked "pitch adjust" in the table below, the high 8 bits contain a MIDI note value. For these sounds, a note value of zero indicates middle C. For other sounds the high byte of REG_SOUND is ignored.

Figure 10: Sound Effect

| Value | Effect | Continuous | Pitch Adjust |
|-------|---------------|------------|--------------|
| 00h | Silence | Y | N |
| 01h | Square Wave | Y | Y |
| 02h | Sine Wave | Y | Y |
| 03h | Sawtooth Wave | Y | Y |
| 04h | Triangle Wave | Y | Y |
| 05h | Beeping | Y | Y |
| 06h | Alarm | Y | Y |
| 07h | Warble | Y | Y |
| 08h | Carousel | Y | Y |
| 10h | 1 short pip | N | Y |
| 11h | 2 short pips | N | Y |
| 12h | 3 short pips | N | Y |
| 13h | 4 short pips | N | Y |
| 14h | 5 short pips | N | Y |
| 15h | 6 short pips | N | Y |
| 16h | 7 short pips | N | Y |
| 17h | 8 short pips | N | Y |
| 18h | 9 short pips | N | Y |
| 19h | 10 short pips | N | Y |
| 1Ah | 11 short pips | N | Y |
| 1Bh | 12 short pips | N | Y |
| 1Ch | 13 short pips | N | Y |
| 1Dh | 14 short pips | N | Y |
| 1Eh | 15 short pips | N | Y |
| 1Fh | 16 short pips | N | Y |
| 23h | DTMF # | Y | N |
| 2Ch | DTMF * | Y | N |
| 30h | DTMF 0 | Y | N |
| 31h | DTMF 1 | Y | N |
| 32h | DTMF 2 | Y | N |
| 33h | DTMF 3 | Y | N |
| 34h | DTMF 4 | Y | N |
| 35h | DTMF 5 | Y | N |
| 36h | DTMF 6 | Y | N |
| 37h | DTMF 7 | Y | N |
| 38h | DTMF 8 | Y | N |
| 39h | DTMF 9 | Y | N |
| 40h | Harp | N | Y |
| 41h | Xylophone | N | Y |
| 42h | Tuba | N | Y |
| 43h | Glockenspiel | N | Y |
| 44h | Organ | N | Y |
| 45h | Trumpet | N | Y |
| 46h | Piano | N | Y |
| 47h | Chimes | N | Y |
| 48h | Music Box | N | Y |
| 49h | Bell | N | Y |
| 50h | Click | N | N |
| 51h | Switch | N | N |
| 52h | Cowbell | N | N |
| 53h | Notch | N | N |
| 54h | Hihat | N | N |
| 55h | Kickdrum | N | N |
| 56h | Pop | N | N |
| 57h | Clack | N | N |
| 58h | Chack | N | N |
| 60h | Mute | N | N |
| 61h | Unmute | N | N |



Figure 11: MIDI Note Effect

| MIDI note | ANSI note | Freq (Hz) | MIDI note | ANSI note | Freq (Hz) | MIDI note | ANSI note | Freq (Hz) | MIDI note | ANSI note | Freq (Hz) |
|-----------|-----------|-----------|-----------|-----------|-----------|-----------|-----------|-----------|-----------|-----------|-----------|
| 21 | A0 | 27.5 | 43 | G2 | 98.0 | 65 | F4 | 349.2 | 87 | D#6 | 1244.5 |
| 22 | A#0 | 29.1 | 44 | G#2 | 103.8 | 66 | F#4 | 370.0 | 88 | E6 | 1318.5 |
| 23 | B0 | 30.9 | 45 | A2 | 110.0 | 67 | G4 | 392.0 | 89 | F6 | 1396.9 |
| 24 | C1 | 32.7 | 46 | A#2 | 116.5 | 68 | G#4 | 415.3 | 90 | F#6 | 1480.0 |
| 25 | C#1 | 34.6 | 47 | B2 | 123.5 | 69 | A4 | 440.0 | 91 | G6 | 1568.0 |
| 26 | D1 | 36.7 | 48 | C3 | 130.8 | 70 | A#4 | 466.2 | 92 | G#6 | 1661.2 |
| 27 | D#1 | 38.9 | 49 | C#3 | 138.6 | 71 | B4 | 493.9 | 93 | A6 | 1760.0 |
| 28 | E1 | 41.2 | 50 | D3 | 146.8 | 72 | C5 | 523.3 | 94 | A#6 | 1864.7 |
| 29 | F1 | 43.7 | 51 | D#3 | 155.6 | 73 | C#5 | 554.4 | 95 | B6 | 1975.5 |
| 30 | F#1 | 46.2 | 52 | E3 | 164.8 | 74 | D5 | 587.3 | 96 | C7 | 2093.0 |
| 31 | G1 | 49.0 | 53 | F3 | 174.6 | 75 | D#5 | 622.3 | 97 | C#7 | 2217.5 |
| 32 | G#1 | 51.9 | 54 | F#3 | 185.0 | 76 | E5 | 659.3 | 98 | D7 | 2349.3 |
| 33 | A1 | 55.0 | 55 | G3 | 196.0 | 77 | F5 | 698.5 | 99 | D#7 | 2489.0 |
| 34 | A#1 | 58.3 | 56 | G#3 | 207.7 | 78 | F#5 | 740.0 | 100 | E7 | 2637.0 |
| 35 | B1 | 61.7 | 57 | A3 | 220.0 | 79 | G5 | 784.0 | 101 | F7 | 2793.8 |
| 36 | C2 | 65.4 | 58 | A#3 | 233.1 | 80 | G#5 | 830.6 | 102 | F#7 | 2960.0 |
| 37 | C#2 | 69.3 | 59 | B3 | 246.9 | 81 | A5 | 880.0 | 103 | G7 | 3136.0 |
| 38 | D2 | 73.4 | 60 | C4 | 261.6 | 82 | A#5 | 932.3 | 104 | G#7 | 3322.4 |
| 39 | D#2 | 77.8 | 61 | C#4 | 277.2 | 83 | B5 | 987.8 | 105 | A7 | 3520.0 |
| 40 | E2 | 82.4 | 62 | D4 | 293.7 | 84 | C6 | 1046.5 | 106 | A#7 | 3729.3 |
| 41 | F2 | 87.3 | 63 | D#4 | 311.1 | 85 | C#6 | 1108.7 | 107 | B7 | 3951.1 |
| 42 | F#2 | 92.5 | 64 | E4 | 329.6 | 86 | D6 | 1174.7 | 108 | C8 | 4186.0 |

6.3. Audio Playback

The FT81x can play back recorded sound through its audio output. To do this, load the original sound data into the FT81x's RAM, and set registers to start the playback.

The registers controlling audio playback are:

- REG_PLAYBACK_START: the start address of the audio data
- REG_PLAYBACK_LENGTH: the length of the audio data, in bytes
- REG_PLAYBACK_FREQ: the playback sampling frequency, in Hz
- REG_PLAYBACK_FORMAT: the playback format, one of LINEAR SAMPLES, uLAW SAMPLES, or ADPCM SAMPLES
- REG_PLAYBACK_LOOP: if zero, the sample is played once. If one, the sample is repeated indefinitely
- REG_PLAYBACK_PLAY: a write to this location triggers the start of audio playback, regardless of writing '0' or '1'. Read back '1' when playback is ongoing, and '0' when playback finishes
- REG_VOL_PB: playback volume, 0-255

The mono audio formats supported are 8-bits PCM, 8-bits uLAW and 4-bits IMA-ADPCM. For ADPCM_SAMPLES, each sample is 4 bits, so two samples are packed per byte, the first sample is in bits 0-3 and the second is in bits 4-7.

The current audio playback read pointer can be queried by reading the REG_PLAYBACK_READPTR. Using a large sample buffer, looping, and this read pointer, the host MPU/MCU can supply a continuous stream of audio.



6.4. General Purpose Input Output

Depending on the package, the FT81x can be configured to use up to 4 GPIO pins. These GPIO pins are controlled by the REG_GPIOX_DIR and REG_GPIOX registers. Alternatively the GPIO0 and GPIO1 pins can also be controlled by REG_GPIO_DIR and REG_GPIO to maintain backward compatibility with the FT800/FT801.

When the QSPI is enabled in Quad mode, GPIO0/IO2 and GPIO1/IO3 pins are used as data lines of the QSPI.

7. Backlight

7.1. Backlight Driver

The EVE2 Module comes equipped with its own backlight driver and integrated backlight control circuit, but if you are running a high brightness or 7" inch display variant, more power may need to be supplied to the display. The EVE2 Module can be configured to provide additional current through pins 17, 18, 19, and 20 by populating the R1 and R2 resistor pads with 0 Ohm resistors. With R1 and R2 populated, additional 3.3V power can be supplied to pins 17 and 18, doubling the amount of current that can be fed to the display.

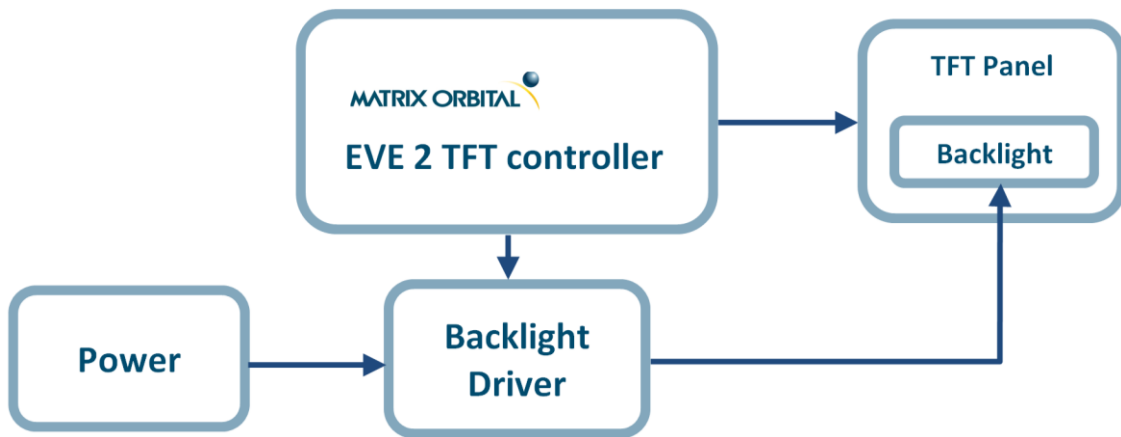

Figure 12: Backlight Driver Block Diagram

8. TFT Display

8.1. EVE2 Module Displays

The EVE2 Module is paired with a Matrix Orbital Parallel TFT display. Information about Matrix Orbital's Parallel TFT lineup, including drawings, dimensions, and tolerances can be found online at:

<https://www.matrixorbital.ca/manuals/parallel-display/mop-tft-manual>

Table 7: EVE2 Parallel Display Datasheet

| EVE2 Display | Parallel TFT Datasheet |
|--------------|------------------------|
| EVE2-29A | MOP-TFT320102-29A |
| EVE2-35A | MOP-TFT320240-35A |
| EVE2-38A | MOP-TFT480116-38A |
| EVE2-43A | MOP-TFT480272-43A |
| EVE2-50A | MOP-TFT800480-50A |
| EVE2-70A | MOP-TFT800480-70A |



8.2. EVE2 TFT Display Timings

Table 8: EVE2 TFT Display Timings

| EVE Timings | Display | | | | | |
|--------------|---------|---------|---------|---------|---------|---------|
| | EVE2-29 | EVE2-35 | EVE2-38 | EVE2-43 | EVE2-50 | EVE2-70 |
| REG_HSIZE | 320 | 320 | 480 | 480 | 800 | 800 |
| REG_VSIZE | 102 | 240 | 272 | 272 | 480 | 480 |
| REG_HCYCLE | 408 | 408 | 524 | 548 | 928 | 928 |
| REG_HOFFSET | 70 | 68 | 43 | 43 | 88 | 88 |
| REG_HSYNC0 | 0 | 0 | 0 | 0 | 0 | 0 |
| REG_HSYNC1 | 10 | 10 | 41 | 41 | 48 | 48 |
| REG_VCYCLE | 262 | 262 | 288 | 292 | 525 | 525 |
| REG_VOFFSET | 156 | 18 | 12 | 12 | 32 | 32 |
| REG_VSYNC0 | 0 | 0 | 156 | 0 | 0 | 0 |
| REG_VSYNC1 | 2 | 2 | 10 | 10 | 3 | 3 |
| REG_PCLK | 8 | 8 | 5 | 5 | 2 | 2 |
| REG_SWIZZLE | 0 | 0 | 0 | 0 | 0 | 0 |
| REG_PCLK_POL | 0 | 0 | 1 | 1 | 1 | 1 |
| REG_CSPREAD | 1 | 1 | 1 | 1 | 0 | 0 |
| REG_DITHER | 1 | 1 | 1 | 1 | 1 | 1 |

9. Electrical Characteristics

9.1. Absolute Maximum Ratings

Table 9: EVE2 Module Limiting Values

| Item | Value | Unit |
|-------------------------------------|-------------------------|------|
| Storage Temperature | -30 to 80 | °C |
| Ambient Temperature (Power Applied) | -20 to +70 | °C |
| VCC Supply Voltage | 0 to +4 | V |
| DC Input Voltage | -0.5 to + (VCCIO + 0.3) | V |

9.2. EVE2 DC Characteristics

Table 10: EVE2 DC characteristics

| Item | Description | Min. | Typ. | Max. | Unit | Conditions |
|------|------------------------------|------|------|------|------|-------------------|
| VCC | VCC operating supply voltage | 2.97 | 3.30 | 3.63 | V | Normal Operation |
| Icc1 | Power Down Current | - | 0.17 | - | mA | Power down mode |
| Icc2 | Sleep Current | - | 0.76 | - | mA | Sleep Mode |
| Icc3 | Standby Current | - | 1.8 | - | mA | Standby Mode |
| Icc4 | Operating Current | - | 22 | - | mA | Normal Operations |

9.3. EVE2 Digital I/O Pin Characteristics

Table 11: Digital I/O Specifications

| Parameter | Description | Min | Typ. | Max | Units | Conditions |
|-----------|----------------------------------|------------|-------|-----|-------|------------------|
| Voh | Output Voltage High | VCCIO- 0.4 | 3.3V- | - | V | Ioh=5mA |
| Vol | Output Voltage Low | - | - | 0.4 | V | Iol=5mA |
| Vih | Input High Voltage | 2.0 | - | - | V | |
| Vil | Input Low Voltage | - | - | 0.8 | V | |
| Vth | Schmitt Hysteresis Voltage | 0.22 | - | 0.3 | V | |
| Iin | Input leakage current | -10 | - | 10 | uA | Vin = VCCIO or 0 |
| Ioz | Tri-state output leakage current | -10 | - | 10 | uA | Vin = VCCIO or 0 |
| Rpu | Pull-up resistor | - | 42 | - | kΩ | |
| Rpd | Pull-down resistor | - | 44 | - | kΩ | |



9.4. Power Specifications

| Parameter | EVE2-29A | EVE2-35A | EVE2-38A | EVE2-43A | EVE2-50A | EVE2-70A | Units |
|------------------------|----------|----------|----------|----------|----------|----------|-------|
| EVE2 Logic | 35 | 35 | 35 | 35 | 35 | 35 | mA |
| TFT Power Supply (max) | 40 | 20 | 30 | 24 | 199.2 | 140 | mA |
| TFT Backlight | Min | 0 | 0 | 0 | 0 | 0 | mA |
| | Typ | 120 | 124 | 240 | 206 | 240 | mA |
| | Max | 144 | 149 | 288 | 247 | 288 | mA |

9.5. Touch Sense Characteristics

Table 12: Touch Panel characteristics

| Parameter | Description | Min | Typ. | Max | Units | Conditions |
|-----------|--|------|------|------|------------|------------|
| Rsw-on | X-,X+,Y- and Y+ Drive On resistance | - | 6 | 10 | Ω | VCCIO=3.3V |
| Rsw-off | X-,X+,Y- and Y+ Drive Off resistance | 10 | - | - | M Ω | |
| Rpu | Touch sense pull up resistance | 78 | 100 | 125 | k Ω | |
| Vth+ | Touch Detection rising-edge threshold on XP pin | 1.59 | - | 2.04 | V | VCCIO=3.3V |
| Vth- | Touch Detection falling-edge threshold on XP pin | 1.23 | - | 1.55 | V | VCCIO=3.3V |
| RI | X-axis and Y-axis drive load resistance | 200 | - | - | Ω | |

10. Mounting

10.1. Extended Capacitive Touch

Extended capacitive touch EVE2 units will come with a double sided adhesive already applied on the exposed back side of the bezel. A 3M 93010LE tape with 300LSE adhesive is used, allowing the display to be easily mounted on flat surfaces. In addition, the tape can maintain its bond in environments of 100% relative humidity at 38°C, and can withstand temperatures up to 149°C.

11. Ordering Options

11.1. Matrix Orbital EVE2 series displays

The EVE2 TFT Module has multiple size and touch variants, to ensure that there is an option for every application. Resistive touch panels are also available, allowing interactive touch functionality for all applications.

Table 13: EVE2 Displays, and GTT counterpart

| Size | Touch Screen Type | Matrix Orbital Part Number | Intelligent Series Upgrade |
|------|-------------------|----------------------------|----------------------------|
| 2.9" | None | EVE2-29A-TPN | GTT29A-TPN-BLM-B0-H1 |
| 3.5" | None | EVE2-38A-TPN | GTT35A-TPN-BLM-B0-H1 |
| | Resistive | EVE2-35A-TPR | GTT35A-TPR-BLM-B0-H1 |
| | Capacitive | EVE2-35G-TPC | GTT35A-TPC-BLM-B0-H1 |
| 3.8" | None | EVE2-38A-TPN | GTT38A-TPN-BLH-B0-H1 |
| | Resistive | EVE2-38A-TPR | GTT38A-TPR-BLH-B0-H1 |
| | Capacitive | EVE2-38G-TPC | GTT38A-TPC-BLH-B0-H1 |
| 4.3" | None | EVE2-43A-TPN | GTT43A-TPN-BLM-B0-H1 |
| | Resistive | EVE2-43A-TPR | GTT43A-TPR-BLM-B0-H1 |
| | Capacitive | EVE2-43G-TPC | GTT43A-TPC-BLM-B0-H1 |
| 5.0" | None | EVE2-50A-TPN | GTT50A-TPN-BLM-B0-H1 |
| | Resistive | EVE2-50A-TPR | GTT50A-TPR-BLM-B0-H1 |
| | Capacitive | EVE2-50G-TPC | GTT50A-TPC-BLM-B0-H1 |
| 7.0" | None | EVE2-70A-TPN | GTT70A-TPN-BLM-B0-H1 |
| | Resistive | EVE2-70A-TPR | GTT70A-TPR-BLM-B0-H1 |
| | Capacitive | EVE2-70G-TPC | GTT70A-TPC-BLM-B0-H1 |



11.2. Matrix Orbital Product Line Comparison

Table 14: Product comparison chart

| Features | | Display Series | | |
|------------------|--------------------|----------------|------|----------|
| | | Parallel | EVE2 | GTT |
| Memory | Storage | | | 2GB |
| | RAM | | 1MB | 32/64MB |
| Interface | RS232 | | | ✓ |
| | TTL | | | ✓ |
| | I2C | | | ✓ |
| | RS422 | | | ✓ |
| | USB | | | ✓ |
| | Parallel | ✓ | | |
| | SPI | | ✓ | |
| Touch | None | ✓ | ✓ | ✓ |
| | Resistive | ✓ | ✓ | ✓ |
| | PCAP | ✓ | ✓ | ✓ |
| | Keyboard | | | ✓ |
| Features | Piezo | | | ✓ |
| | Vibration feedback | | | ✓ |
| | Audio playback | | ✓ | |
| | GPO | | 4 | 10 |
| Voltage | 3.3V | | ✓ | |
| | 5V | ✓ | | ✓ |
| | 9-35V | | | ✓ |
| Development Time | | ••••• | ••• | • |
| Cost | | \$ | \$\$ | \$\$\$\$ |

11.3. Software Support

Table 15: EVE Screen Editor and GTT Designer Suite comparison

| Features | FTDI/Bridgetek EVE Screen Editor | GTT Designer Suite |
|-----------------------------------|----------------------------------|--------------------|
| Drag and drop functionality | ✓ | ✓ |
| Send commands directly to display | ✓ | ✓ |
| Command list generation | ✓ | ✓ |
| Intuitive design format | ✓ | ✓ |
| Deploy screens to the display | - | ✓ |
| Multiple screen generation | - | ✓ |
| Device Inspector | ✓ | - |



12. Dimensional Drawing

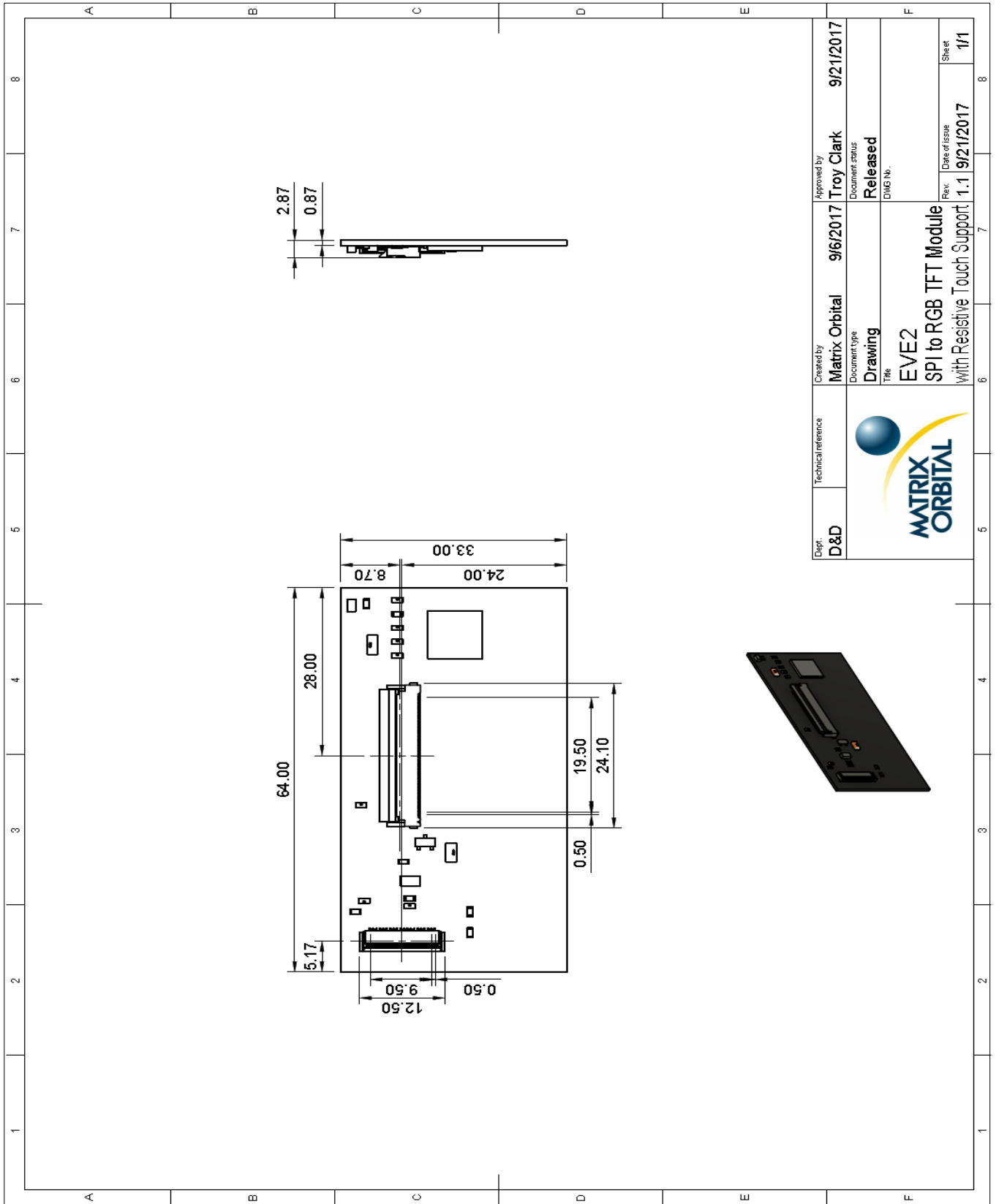

Figure 13: EVE2 TFT Module Technical Drawing



Компания «Океан Электроники» предлагает заключение долгосрочных отношений при поставках импортных электронных компонентов на взаимовыгодных условиях!

Наши преимущества:

- Поставка оригинальных импортных электронных компонентов напрямую с производств Америки, Европы и Азии, а так же с крупнейших складов мира;
- Широкая линейка поставок активных и пассивных импортных электронных компонентов (более 30 млн. наименований);
- Поставка сложных, дефицитных, либо снятых с производства позиций;
- Оперативные сроки поставки под заказ (от 5 рабочих дней);
- Экспресс доставка в любую точку России;
- Помощь Конструкторского Отдела и консультации квалифицированных инженеров;
- Техническая поддержка проекта, помощь в подборе аналогов, поставка прототипов;
- Поставка электронных компонентов под контролем ВП;
- Система менеджмента качества сертифицирована по Международному стандарту ISO 9001;
- При необходимости вся продукция военного и аэрокосмического назначения проходит испытания и сертификацию в лаборатории (по согласованию с заказчиком);
- Поставка специализированных компонентов военного и аэрокосмического уровня качества (Xilinx, Altera, Analog Devices, Intersil, Interpoint, Microsemi, Actel, Aeroflex, Peregrine, VPT, Syfer, Eurofarad, Texas Instruments, MS Kennedy, Miteq, Cobham, E2V, MA-COM, Hittite, Mini-Circuits, General Dynamics и др.);

Компания «Океан Электроники» является официальным дистрибьютором и эксклюзивным представителем в России одного из крупнейших производителей разъемов военного и аэрокосмического назначения «JONHON», а так же официальным дистрибьютором и эксклюзивным представителем в России производителя высокотехнологичных и надежных решений для передачи СВЧ сигналов «FORSTAR».



JONHON

«JONHON» (основан в 1970 г.)

Разъемы специального, военного и аэрокосмического назначения:

(Применяются в военной, авиационной, аэрокосмической, морской, железнодорожной, горно- и нефтедобывающей отраслях промышленности)

«FORSTAR» (основан в 1998 г.)

ВЧ соединители, коаксиальные кабели, кабельные сборки и микроволновые компоненты:

(Применяются в телекоммуникациях гражданского и специального назначения, в средствах связи, РЛС, а так же военной, авиационной и аэрокосмической отраслях промышленности).



Телефон: 8 (812) 309-75-97 (многоканальный)

Факс: 8 (812) 320-03-32

Электронная почта: ocean@oceanchips.ru

Web: <http://oceanchips.ru/>

Адрес: 198099, г. Санкт-Петербург, ул. Калинина, д. 2, корп. 4, лит. А