

## Applications

- Military Radar
- Electronic Warfare
- Test Equipment

## Product Features

- Frequency Range: 2 to 18 GHz
- $P_{SAT}$ : 40 dBm at  $V_D = 30$  V
- PAE: 20% Typical
- Small Signal Gain: 10 dB
- Return Loss: 15 dB
- Bias:  $V_D = 30$  V,  $I_{DQ} = 500$  mA,  $V_G = -2.3$  V Typical
- Technology: 0.25- $\mu$ m GaN on SiC
- Dimensions: 5.66 x 2.67 x 0.5 mm

## General Description

The Qorvo TGA2573-2-TS is a wideband, high power GaN HEMT amplifier fabricated on Qorvo's production 0.25- $\mu$ m GaN on SiC process. Operating from 2 to 18 GHz, it achieves 40 dBm saturated output power, 20% PAE, and 10 dB small signal gain at a drain bias of 30 V.

The TGA2573-2-TS is a 4-mil thick GaN die mounted on a 15 mil thick Cu-Mo-Cu carrier. This provides the customer a known good die attach to assist in thermal management and provide easier handling

Fully matched to 50  $\Omega$  and with integrated DC blocking caps on both RF ports, the TGA2573-2-TS is ideally suited to support both commercial and defense related applications.

The TGA2573-2-TS is 100% DC and RF tested on-wafer to ensure compliance to performance specifications.

Lead-free and RoHS compliant.

*The information contained on this data sheet is technical information as defined by 22 CFR 120.10 and is therefore US export controlled. Export or transfer contrary to US law is prohibited.*

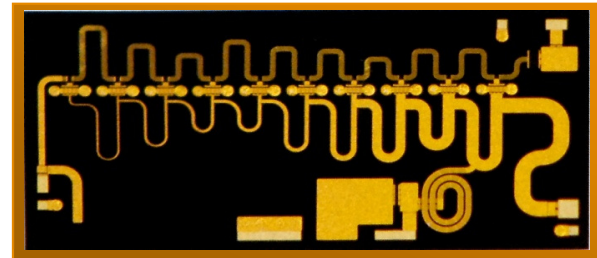

## Functional Block Diagram

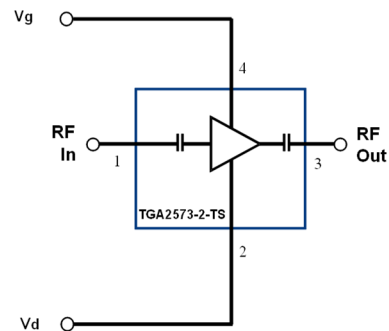

## Pad Configuration

Pad No.	Symbol
1	RF In
2	$V_D$
3	RF Out
4	$V_G$

## Ordering Information

Part	ECCN	Description
TGA2573-2-TS	3A611.x	Die on Thermal Spreader

### Absolute Maximum Ratings

Parameter	Value
Drain Voltage ( $V_D$ ) <sup>(1)</sup>	40 V
Gate Voltage Range ( $V_G$ )	-8 to 0 V
Drain-to-Gate Voltage ( $V_{DG}$ )	80 V
Drain Current ( $I_D$ ) <sup>(1) (2)</sup>	1.3 A
Gate Current ( $I_G$ ) @ $T = 85$ °C	-4 to 11 mA
Power Dissipation ( $P_{DISS}$ )	30 W
RF Input Power, CW, 50 $\Omega$ , $T = 25$ °C ( $P_{IN}$ ) <sup>(1)</sup>	35 dBm
Channel Temperature ( $T_{CH}$ )	275 °C
Mounting Temperature (30 Seconds)	320 °C
Storage Temperature	-55 to 150 °C

Operation of this device outside the parameter ranges given above may cause permanent damage. These are stress ratings only, and functional operation of the device at these conditions is not implied.

### Recommended Operating Conditions

Parameter	Min	Typ	Max	Units
Drain Voltage ( $V_D$ )		30	35	V
Drain Current ( $I_D$ )		500		mA
Drain Current Under RF Drive ( $I_{D\_DRIVE}$ ) <sup>(1)</sup>		1200		mA
Gate Voltage ( $V_G$ )		-2.3		V

Electrical specifications are measured at specified test conditions. Specifications are not guaranteed over all recommended operating conditions.

### Electrical Specifications

Test conditions unless otherwise noted: 25 °C,  $V_D = 30$  V,  $I_{DQ} = 500$  mA,  $V_G = -2.3$  V Typical

Parameter	Typical	Units
Operational Frequency Range	2 to 18	GHz
Small Signal Gain	10	dB
Input Return Loss	15	dB
Output Return Loss	15	dB
Output Power at Saturation (Input Power = 35 dBm)	40	dBm
Output Power at 30 dBm Input Power	38	dBm
Power Added Efficiency	20	%
Output TOI at $P_{out}/tone = 25$ dBm	45	dBm
Noise Figure	6	dB
Small Signal Gain Temperature Coefficient	-0.02	dB/°C
Output Power Temperature Coefficient	-0.005	dBm/°C

The information contained on this data sheet is technical information as defined by 22 CFR 120.10 and is therefore US export controlled. Export or transfer contrary to US law is prohibited.

### Thermal and Reliability Information

Parameter	Test Conditions	Value	Units
Thermal Resistance ( $\theta_{JC}$ ) <sup>(1)</sup>	$P_{DISS} < 17\text{ W}$	5.4	$^{\circ}\text{C/W}$
	$17\text{ W} < P_{DISS} < 27\text{ W}$	6.0	$^{\circ}\text{C/W}$
	$P_{DISS} > 27\text{ W}$	6.2	$^{\circ}\text{C/W}$
Channel Temperature ( $T_{CH}$ )	$V_D = 30\text{ V}$ , $I_D = 500\text{ mA}$ , $P_{DISS} = 15\text{ W}$ , $T_{BASE} = 85\text{ }^{\circ}\text{C}$	166	$^{\circ}\text{C}$
Median Lifetime ( $T_M$ )		$3.2 \times 10^8$	Hrs
Maximum Channel Temperature ( $T_{CH}$ ), Under RF Drive	See plots below		

Notes:

1. Thermal resistance measured to back of carrier.

### Median Lifetime and Channel Temperature Rise

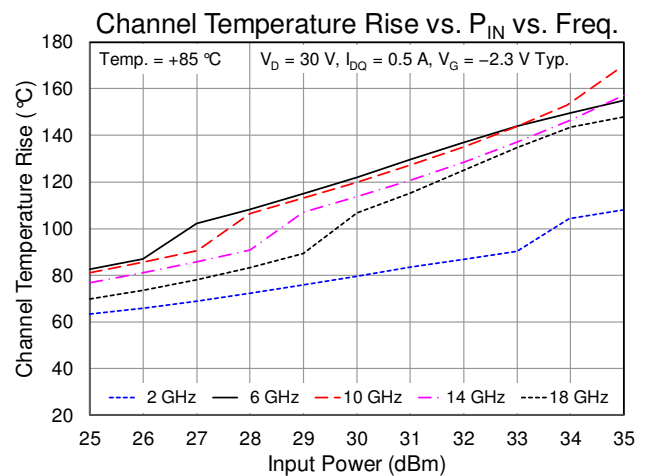
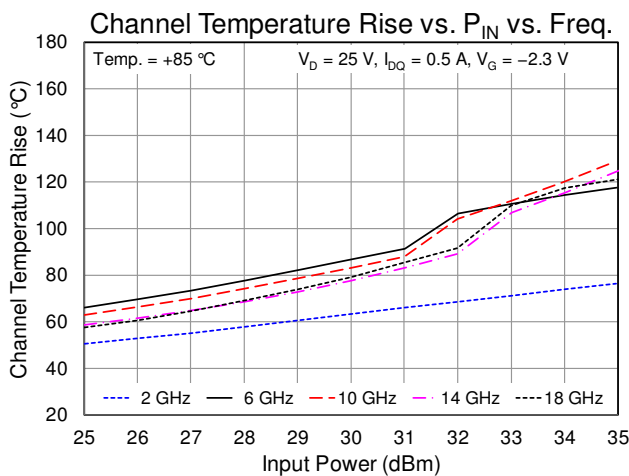
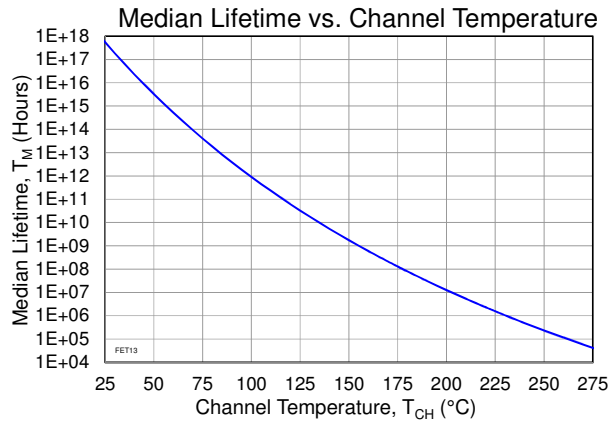

The information contained on this data sheet is technical information as defined by 22 CFR 120.10 and is therefore US export controlled. Export or transfer contrary to US law is prohibited.

**Typical Performance**

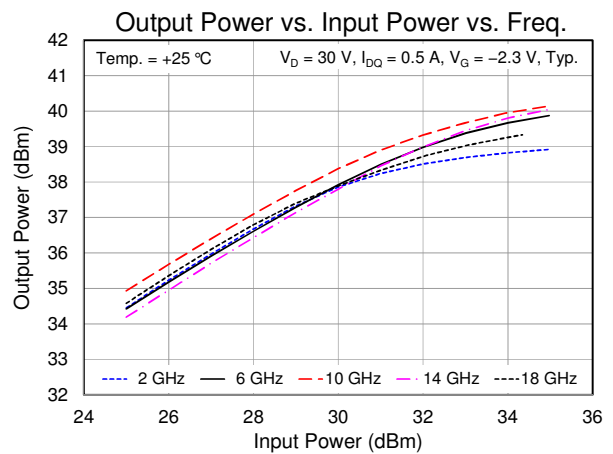
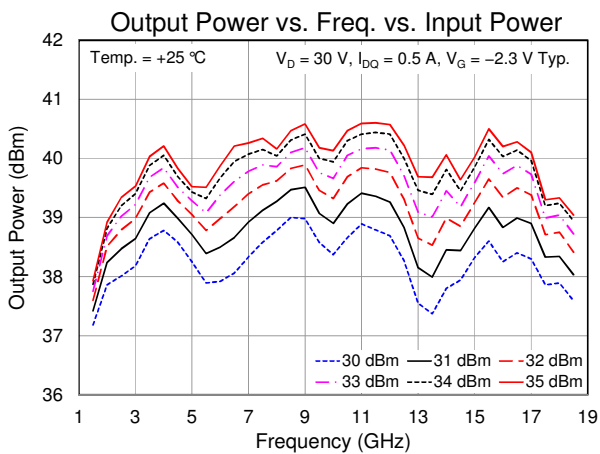
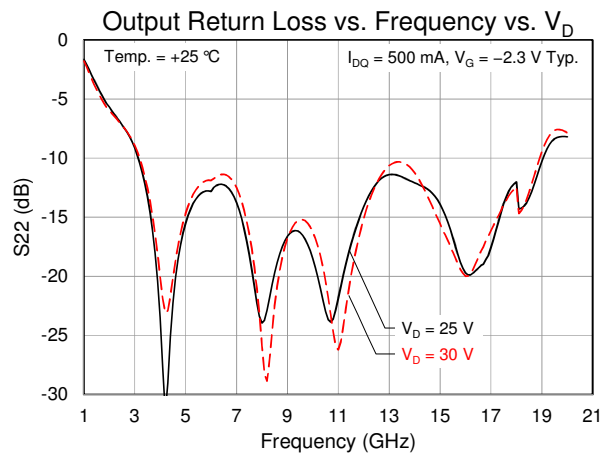
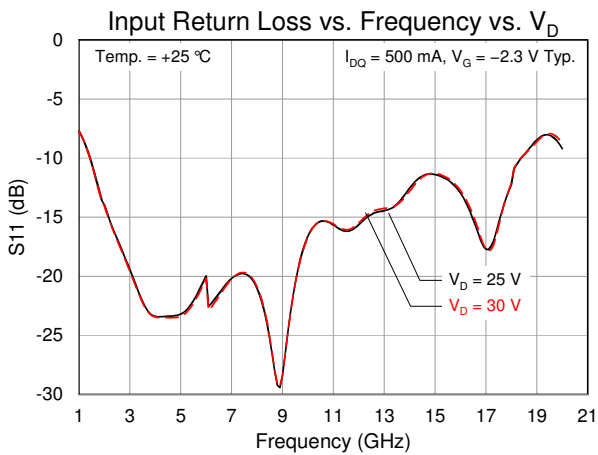
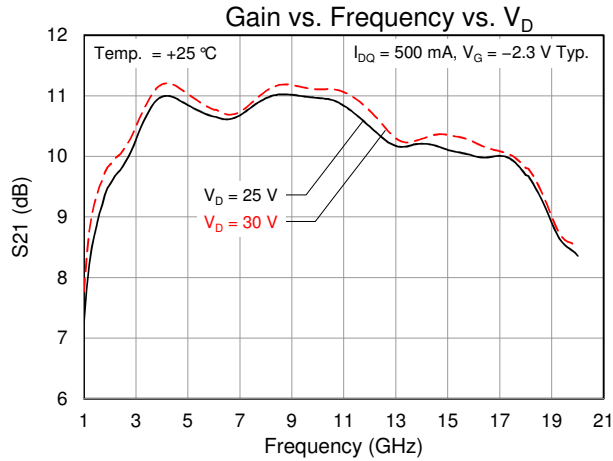

The information contained on this data sheet is technical information as defined by 22 CFR 120.10 and is therefore US export controlled. Export or transfer contrary to US law is prohibited.

**Typical Performance**

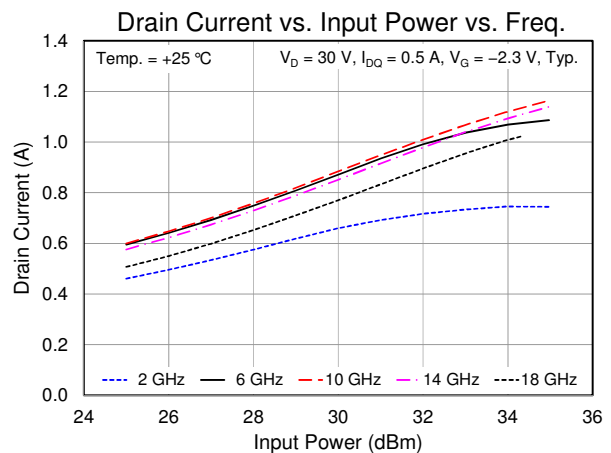
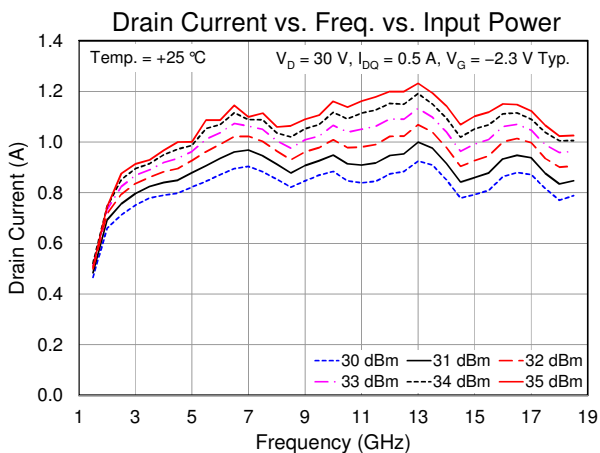
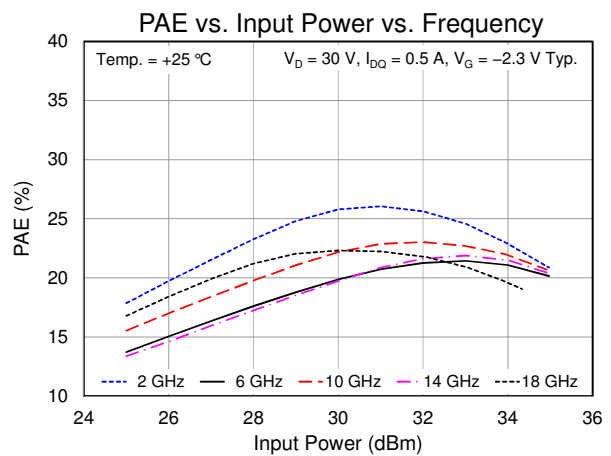
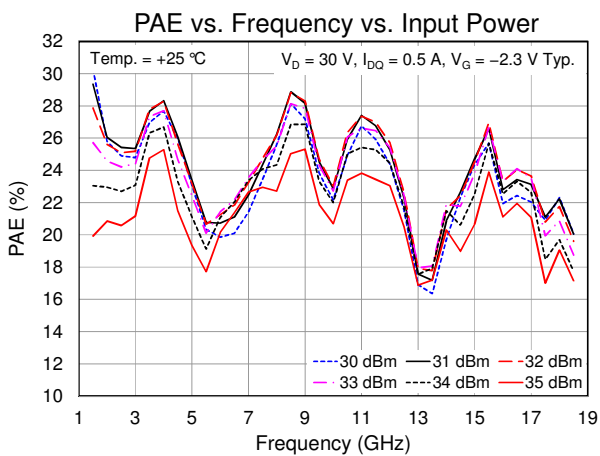
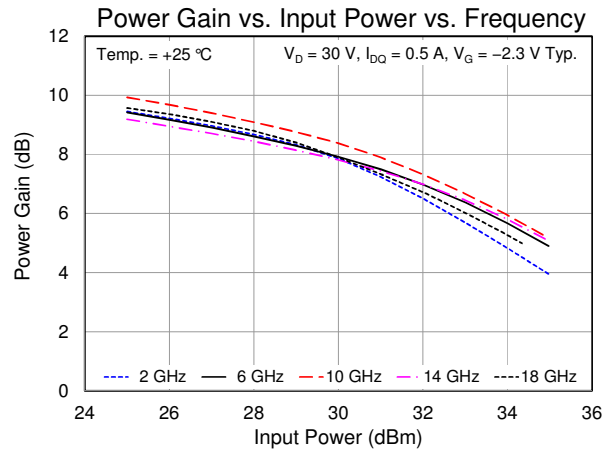
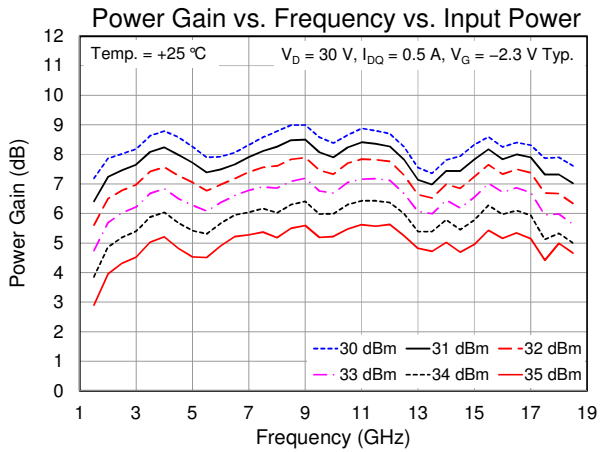

The information contained on this data sheet is technical information as defined by 22 CFR 120.10 and is therefore US export controlled. Export or transfer contrary to US law is prohibited.

**Typical Performance**

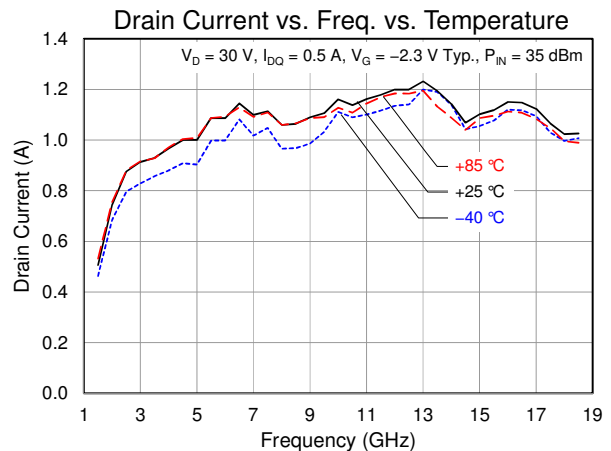
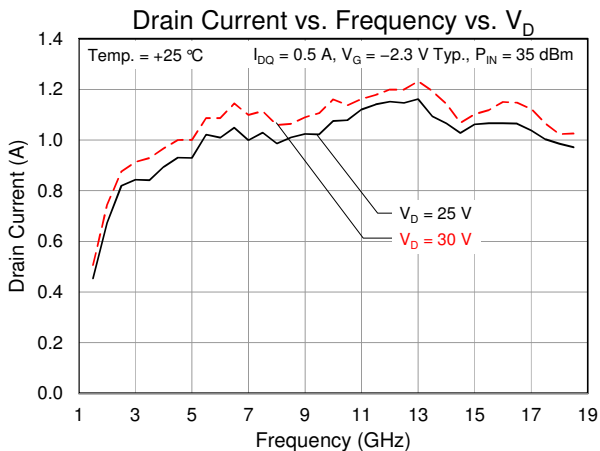
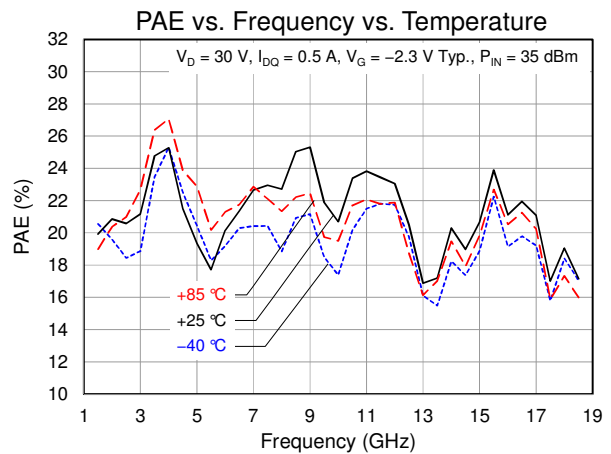
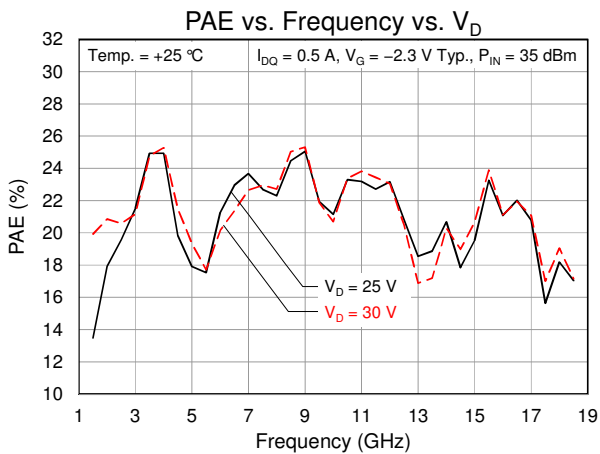
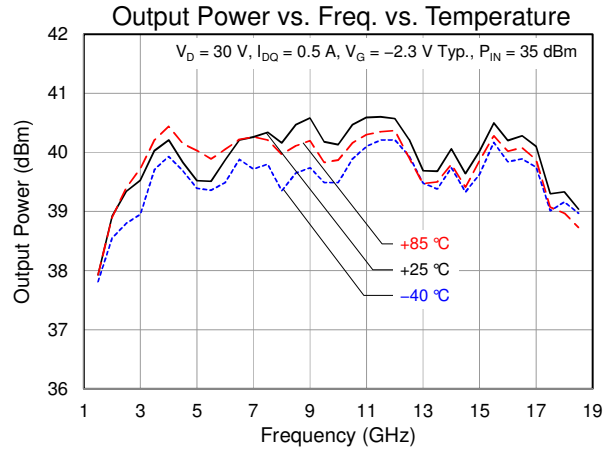
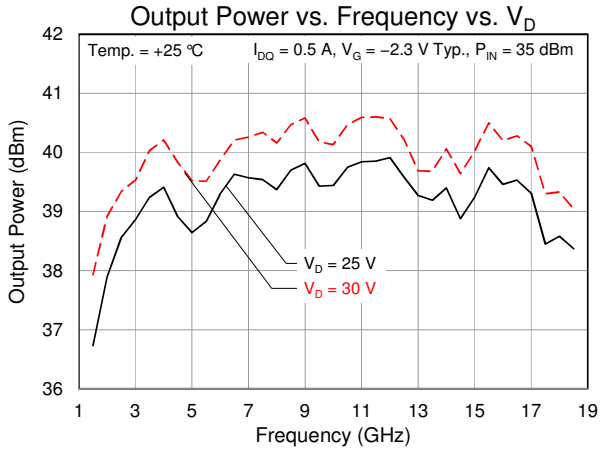

The information contained on this data sheet is technical information as defined by 22 CFR 120.10 and is therefore US export controlled. Export or transfer contrary to US law is prohibited.

**Typical Performance**

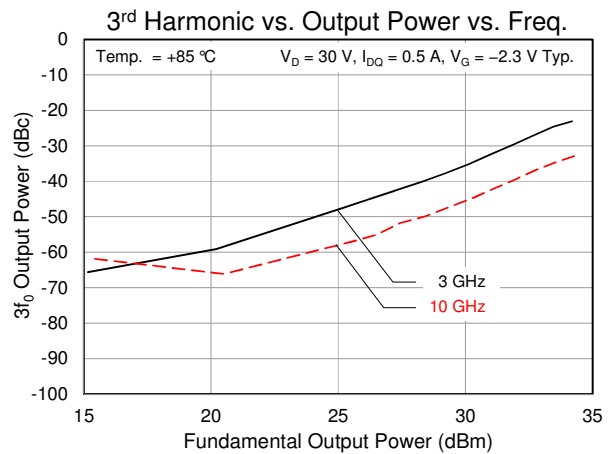
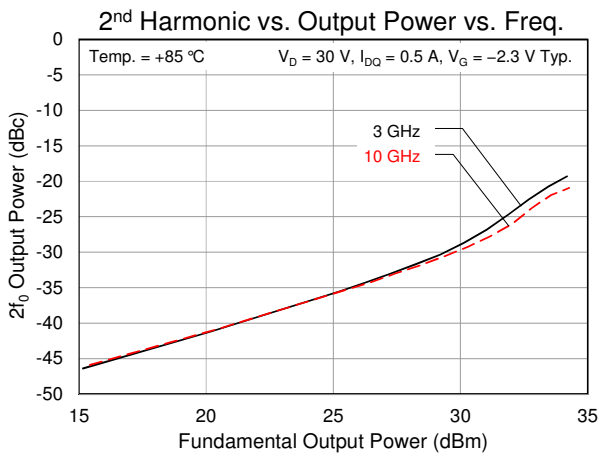
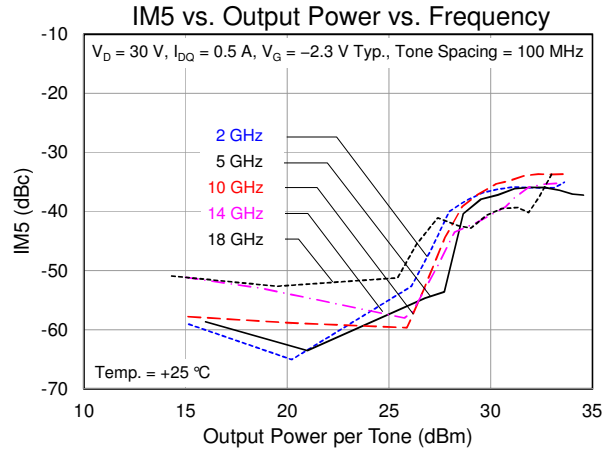
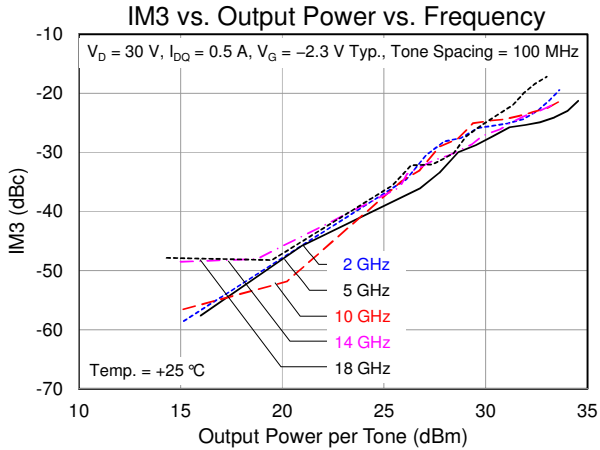

The information contained on this data sheet is technical information as defined by 22 CFR 120.10 and is therefore US export controlled. Export or transfer contrary to US law is prohibited.

## Application Circuit

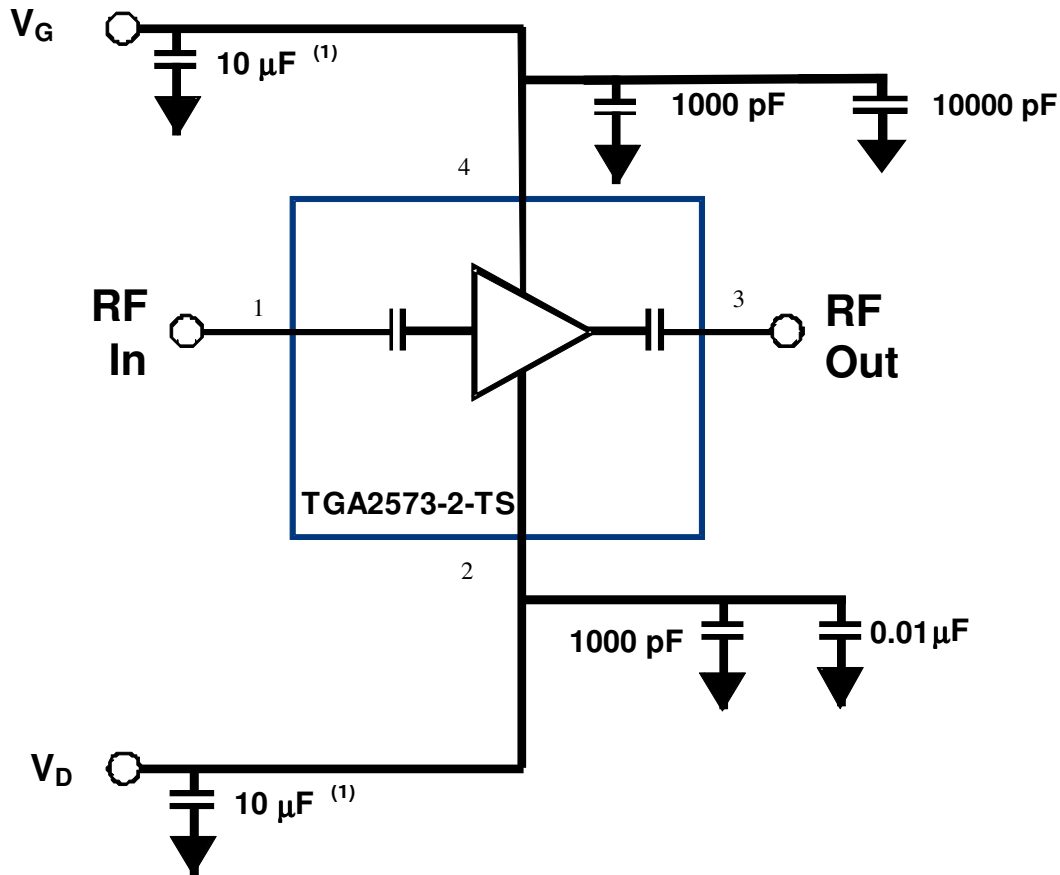

### Notes:

1. Additional bypass capacitors may be required at this location. The value of these capacitors varies by application. Variables include power supply impedance, power supply stability with reactive loads, and the inductance from the power supply to this assembly. One to 47 uF tantalum capacitors are commonly used here.

### Bias-up Procedure

1. Set  $I_D$  limit to 1.3 A,  $I_G$  limit to 3 mA
2. Apply -5.0 V to  $V_G$
3. Apply +30 V to  $V_D$
4. Adjust  $V_G$  more positive until  $I_{DQ} = 500$  mA ( $V_G \sim -2.3$  V Typical)
5. Apply RF signal

### Bias-down Procedure

1. Turn off RF signal
2. Reduce  $V_G$  to -5.0 V. Ensure  $I_{DQ} \sim 0$  mA
3. Set  $V_D$  to 0 V
4. Turn off  $V_D$  supply
5. Turn off  $V_G$  supply

The information contained on this data sheet is technical information as defined by 22 CFR 120.10 and is therefore US export controlled. Export or transfer contrary to US law is prohibited.



## Bond Pad Description

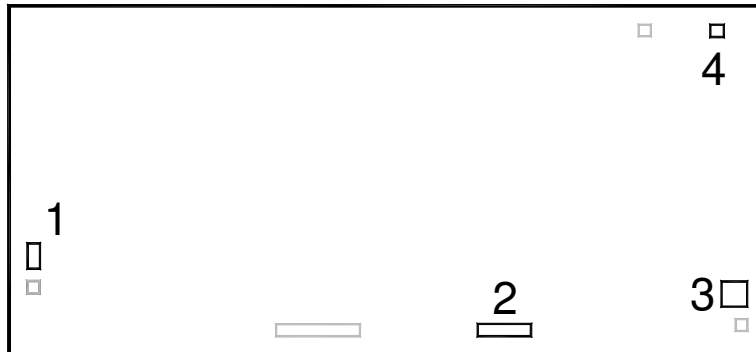

## Bond Pads

Pad No.	Symbol	Description
1	RF In	Input; matched to 50 $\Omega$
2	V <sub>D</sub>	Drain voltage; bias network is required; see Application Circuit on page 8 as an example
3	RF Out	Output, matched to 50 $\Omega$
4	V <sub>G</sub>	Gate voltage; bias network is required; see Application Circuit on page 8 as an example
Backside	GND	Backside of carrier

The information contained on this data sheet is technical information as defined by 22 CFR 120.10 and is therefore US export controlled. Export or transfer contrary to US law is prohibited.

**Assembly Drawing**

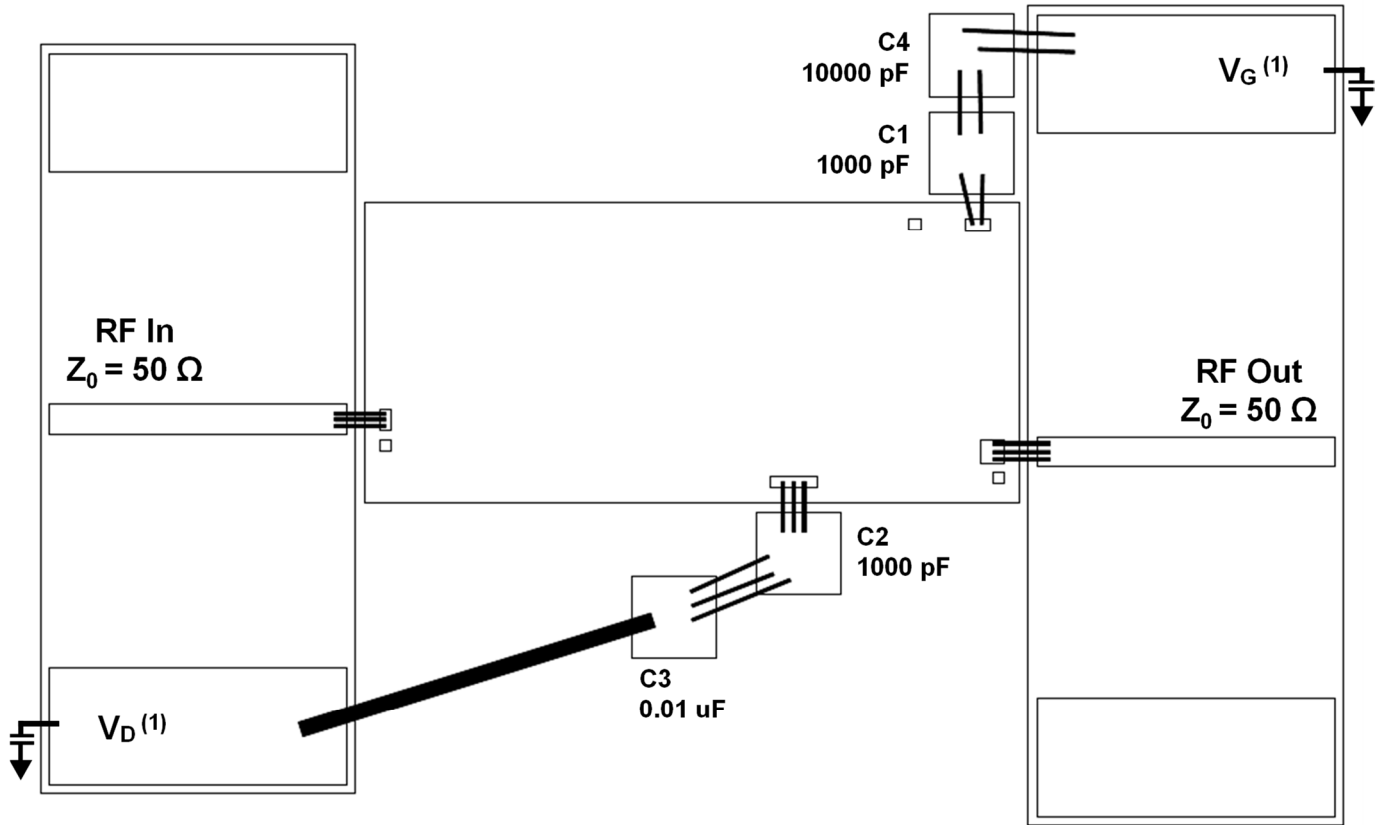

Notes:

1. See Application Circuit page 8 Note 1

**Bill of Material**

Ref Des.	Value	Description	Manufacturer	Part Number
C1, C2	1000 pF	Cap, 50 V, 10%, Single Layer	various	
C3	0.01 $\mu$ F	Cap, 50 V, 10%, SMD	various	
C4	10000 pF	Cap, 50 V, 10%, Single Layer	various	

The information contained on this data sheet is technical information as defined by 22 CFR 120.10 and is therefore US export controlled. Export or transfer contrary to US law is prohibited.

**Mechanical Information**

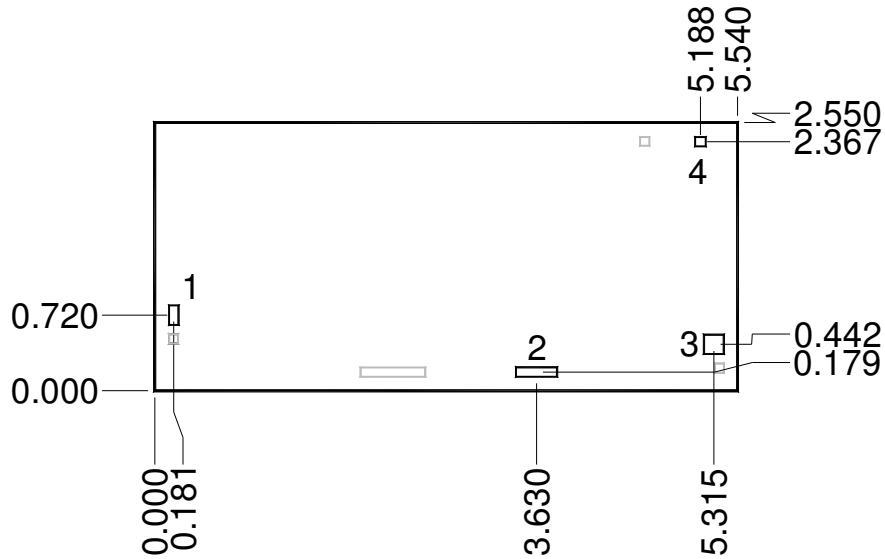

Unit: millimeters  
 Thickness: 0.10  
 Die x, y size tolerance: ± 0.050  
 Chip edge to bond pad dimensions are shown to center of pad  
 Ground is backside of die

**Bond Pad Dimensions**

Pad No.	Symbol	Pad Size
1	RF In	0.100 x 0.195
2	V <sub>D</sub>	0.400 x 0.100
3	RF Out	0.200 x 0.195
4	V <sub>G</sub>	0.110 x 0.100

The information contained on this data sheet is technical information as defined by 22 CFR 120.10 and is therefore US export controlled. Export or transfer contrary to US law is prohibited.

**Mechanical Information – Die on Carrier**

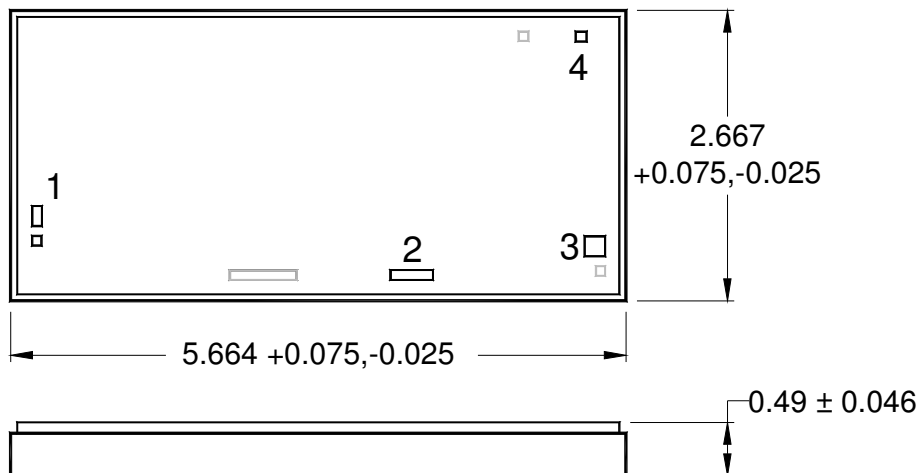

Unit: millimeters  
 Material for carrier:  
     Cu-Mo-Cu  
     Thickness: 0.381 ± 0.025  
 Plating for carrier:  
     Gold (Au) over Nickel (Ni)  
 MMIC die is attached to carrier using solder  
 MMIC die is nominally centered on carrier.

**Assembly Notes**

Component placement assembly notes:

- Vacuum pencils and/or vacuum collets are the preferred method of pick up.
- Air bridges must be avoided during placement.
- The force impact is critical during auto placement.

Interconnect process assembly notes:

- Thermosonic ball bonding is the preferred interconnect technique.
- Force, time, and ultrasonics are critical parameters.
- Aluminum wire should not be used.
- Devices with small pad sizes should be bonded with 0.0007-inch wire.

*The information contained on this data sheet is technical information as defined by 22 CFR 120.10 and is therefore US export controlled. Export or transfer contrary to US law is prohibited.*

## Product Compliance Information

### ESD Sensitivity Ratings



Caution! ESD-Sensitive Device

ESD Rating: TBD  
Value: TBD  
Test: Human Body Model (HBM)  
Standard: JEDEC Standard JESD22-A114

### ECCN

US Department of State 3A611.x

### RoHS Compliance

This part is compliant with the 2011/65/EU RoHS directive (Restrictions on the Use of Certain Hazardous Substances in Electrical and Electronic Equipment), as amended by Directive 2015/863/EU.

This product also has the following attributes:

- Lead Free
- Halogen Free (Chlorine, Bromine)
- Antimony Free
- TBBP-A (C<sub>15</sub>H<sub>12</sub>Br<sub>4</sub>O<sub>2</sub>) Free
- PFOS Free
- SVHC Free

## Contact Information

For the latest specifications, additional product information, worldwide sales and distribution locations, and information about Qorvo:

**Web:** [www.qorvo.com](http://www.qorvo.com)  
**Email:** [info-sales@qorvo.com](mailto:info-sales@qorvo.com)

**Tel:** +1.972.994.8465  
**Fax:** +1.972.994.8504

For technical questions and application information: **Email:** [info-products@qorvo.com](mailto:info-products@qorvo.com)

## Important Notice

The information contained herein is believed to be reliable. Qorvo makes no warranties regarding the information contained herein. Qorvo assumes no responsibility or liability whatsoever for any of the information contained herein. Qorvo assumes no responsibility or liability whatsoever for the use of the information contained herein. The information contained herein is provided "AS IS, WHERE IS" and with all faults, and the entire risk associated with such information is entirely with the user. All information contained herein is subject to change without notice. Customers should obtain and verify the latest relevant information before placing orders for Qorvo products. The information contained herein or any use of such information does not grant, explicitly or implicitly, to any party any patent rights, licenses, or any other intellectual property rights, whether with regard to such information itself or anything described by such information.

Qorvo products are not warranted or authorized for use as critical components in medical, life-saving, or life-sustaining applications, or other applications where a failure would reasonably be expected to cause severe personal injury or death.

*The information contained on this data sheet is technical information as defined by 22 CFR 120.10 and is therefore US export controlled. Export or transfer contrary to US law is prohibited.*

Компания «Океан Электроники» предлагает заключение долгосрочных отношений при поставках импортных электронных компонентов на взаимовыгодных условиях!

Наши преимущества:

- Поставка оригинальных импортных электронных компонентов напрямую с производств Америки, Европы и Азии, а так же с крупнейших складов мира;
- Широкая линейка поставок активных и пассивных импортных электронных компонентов (более 30 млн. наименований);
- Поставка сложных, дефицитных, либо снятых с производства позиций;
- Оперативные сроки поставки под заказ (от 5 рабочих дней);
- Экспресс доставка в любую точку России;
- Помощь Конструкторского Отдела и консультации квалифицированных инженеров;
- Техническая поддержка проекта, помощь в подборе аналогов, поставка прототипов;
- Поставка электронных компонентов под контролем ВП;
- Система менеджмента качества сертифицирована по Международному стандарту ISO 9001;
- При необходимости вся продукция военного и аэрокосмического назначения проходит испытания и сертификацию в лаборатории (по согласованию с заказчиком);
- Поставка специализированных компонентов военного и аэрокосмического уровня качества (Xilinx, Altera, Analog Devices, Intersil, Interpoint, Microsemi, Actel, Aeroflex, Peregrine, VPT, Syfer, Eurofarad, Texas Instruments, MS Kennedy, Miteq, Cobham, E2V, MA-COM, Hittite, Mini-Circuits, General Dynamics и др.);

Компания «Океан Электроники» является официальным дистрибьютором и эксклюзивным представителем в России одного из крупнейших производителей разъемов военного и аэрокосмического назначения «JONHON», а так же официальным дистрибьютором и эксклюзивным представителем в России производителя высокотехнологичных и надежных решений для передачи СВЧ сигналов «FORSTAR».



## JONHON

«JONHON» (основан в 1970 г.)

Разъемы специального, военного и аэрокосмического назначения:

(Применяются в военной, авиационной, аэрокосмической, морской, железнодорожной, горно- и нефтедобывающей отраслях промышленности)

«FORSTAR» (основан в 1998 г.)

ВЧ соединители, коаксиальные кабели, кабельные сборки и микроволновые компоненты:

(Применяются в телекоммуникациях гражданского и специального назначения, в средствах связи, РЛС, а так же военной, авиационной и аэрокосмической отраслях промышленности).



Телефон: 8 (812) 309-75-97 (многоканальный)

Факс: 8 (812) 320-03-32

Электронная почта: [ocean@oceanchips.ru](mailto:ocean@oceanchips.ru)

Web: <http://oceanchips.ru/>

Адрес: 198099, г. Санкт-Петербург, ул. Калинина, д. 2, корп. 4, лит. А