

General Description

The AL5809Q is a two terminal constant current linear LED driver and it provides a cost-effective solution. It offers an excellent temperature stability 20 ppm/°C and the current accuracy $\pm 5\%$ regulated over a wide voltage range. The AL5809Q simplifies the design for linear LED drivers allowing it to be designed as a high or low-side constant current regulator without any external components.

The AL5809Q turns on immediately and can swing from 2.5V up to 60V enabling it drive long LED chains. The floating ground, 60V Voltage rating between Input and Output pins designed to withstand the high peak voltage incurred in DC and offline applications.

The AL5809QE1-XXX (from 15 to 150 mA) is available in thermally robust POWERDI-123 package with different current options, please see ordering information section.

Key Features

- Low Minimum Operating Voltage (2.5V to 60V)
- -40°C to 125°C Temperature Range
- $\pm 5\%$ LED Current Accuracy
- PDI-123 package

Applications

- Constant LED Current Driver
- Isolated Offline LED Converters
- LED Signs
- Instrumentation Illumination

Specifications

Parameter	Value
Input Voltage	2.5V – 60V
LED Current Options	15 to 150mA
XYZ Dimension	0.69" x 0.77" x 0.1"
ROHS Compliance	Yes

Top-View EVM (AL5809QE1)



AL5809QE1 (PDI123)

Bottom-View EVM (AL5809QE1)

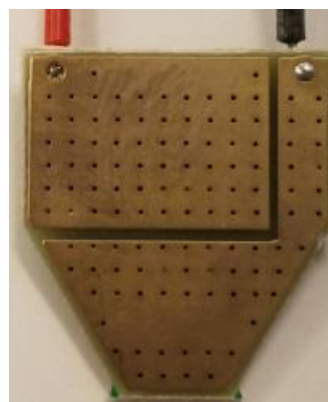

Connection Instructions

IN: Red Wire (LED connection)
 OUT: Black Wire

Board Layout

(a) Top View

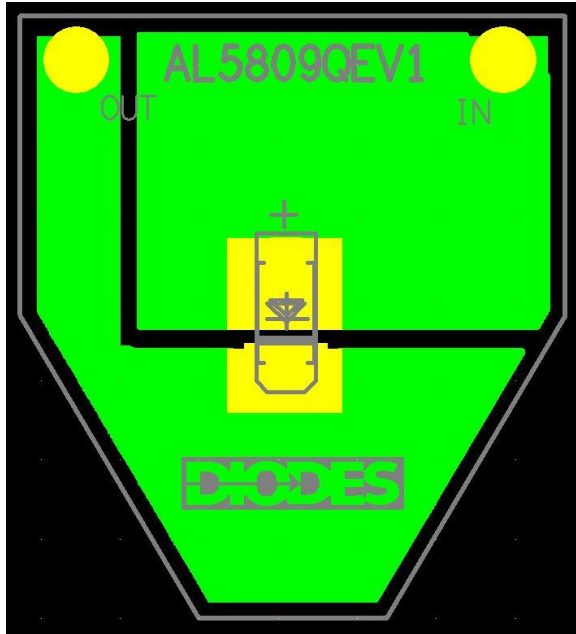

(b) Bottom View

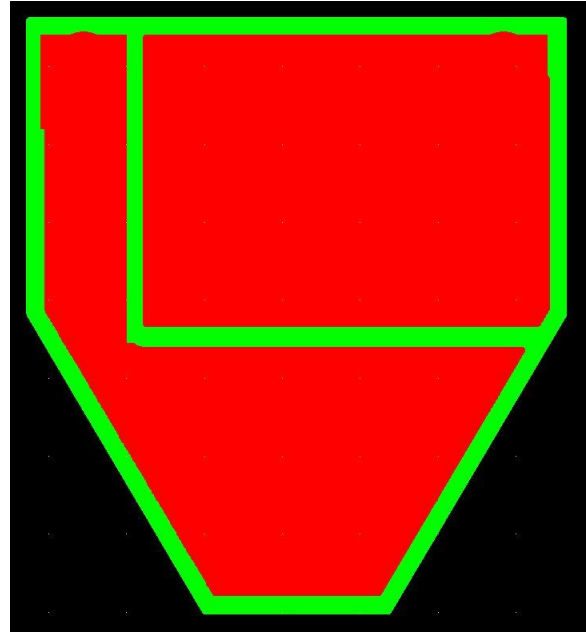

Note: This evaluation board provides design flexibility, multiple application circuits can be derived in both Low and High Side Current LED configurations. The footprint of U1 is compatible to both of **PDI-123** and **SOD-123** packages. In addition, it can be hooked up with use of PWM dimming.

Connection Setup and Power-up Procedures

Current LED String Procedure to Evaluation Board in Low side current LED configuration

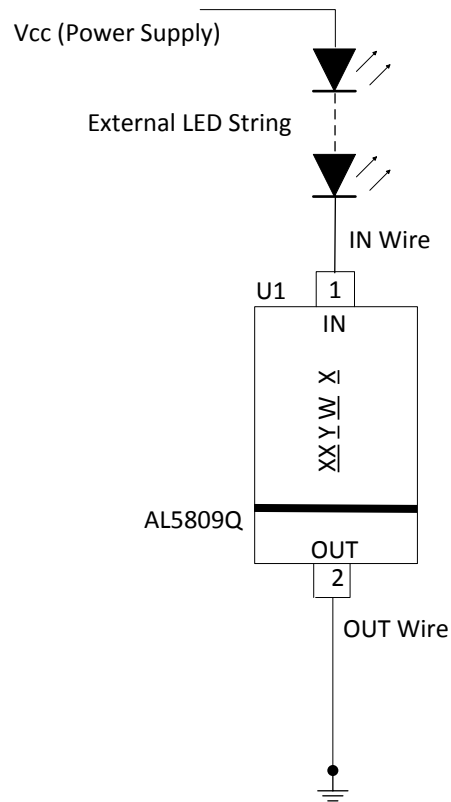

1. Depends on the current options, the evaluation board is as low side current LED configuration.
2. Ensure that the DC source is switched OFF or disconnected.
3. Connect the power supply to Anode terminal of external LED string in the Low side LED configuration.
4. Connect the Cathode terminals of external LED string to IN terminal of the board and connect OUT wire to GND.
5. Ensure that the area around the board is clear and safe, and preferably that the board and LEDs are enclosed in a transparent safety cover.
6. Turn on the main switch. LED string should light up and the LED current should be regulated according to the current options of the device.

Bill of Material

#	Name	Quantity	Part number	Manufacturer	Description
1	U1	1	AL5809Q-xxxP1-7	Diodes Inc	Constant Current Regulator in PDI123

Ordering Information

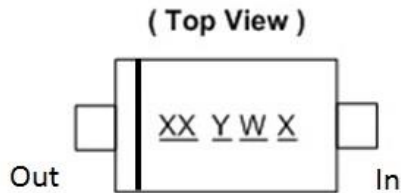
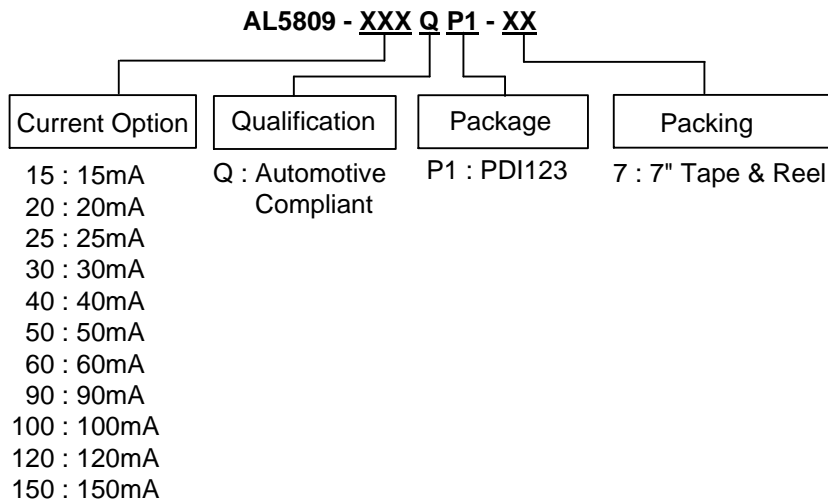

XX : Identification code
Y : Year 0 to 9
W : Week : A to Z : 1 to 26 week;
 a to z : 27 to 52 week; z represents
 52 and 53 week
X : Internal code

Part Number	LED Current Option	Package	Identification Code
AL5809Q-15P1-7	15mA	PDI123	C1
AL5809Q-20P1-7	20mA	PDI123	C2
AL5809Q-25P1-7	25mA	PDI123	CA
AL5809Q-30P1-7	30mA	PDI123	C3
AL5809Q-40P1-7	40mA	PDI123	C4
AL5809Q-50P1-7	50mA	PDI123	C5
AL5809Q-60P1-7	60mA	PDI123	C6
AL5809Q-90P1-7	90mA	PDI123	C7

AL5809Q-100P1-7	100mA	PDI123	CB
AL5809Q-120P1-7	120mA	PDI123	C8
AL5809Q-150P1-7	150mA	PDI123	C9

Application Information

I) Current LED String Procedure in High side current LED configuration

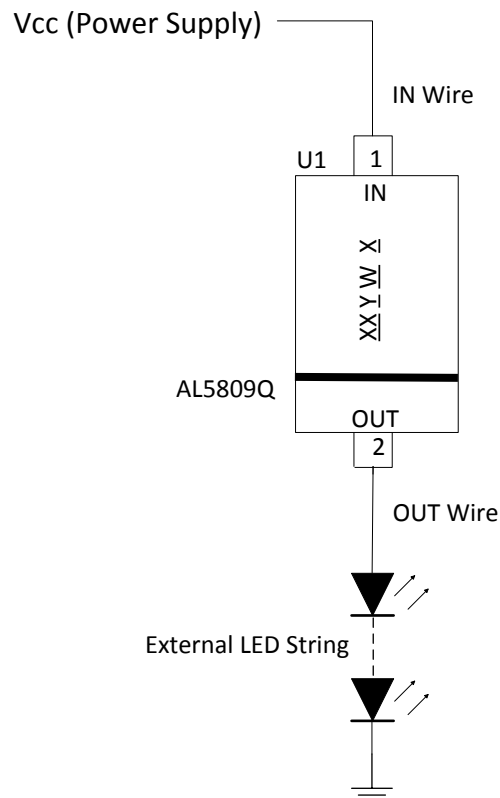

1. The evaluation can also be configured as High side current LED configuration.
2. Ensure that the DC source is switched OFF or disconnected.
3. Connect the power supply to IN terminal wire on the board.
4. Connect the Anode and Cathode terminals of external LED string between OUT terminal and GND in the High side LED configuration.
5. Observe MAX 60V differential between IN and OUT terminals when applied Vcc > 60V.
6. **In the high side circuit configuration, extreme high voltage may be present. Please use caution and try not to touch any components on the board or input leads.**
7. Turn on the main switch. LED string should light up and the LED current should be regulated according to the current options of the device.

II) PWM Dimming

The AL5809Q can be used to provide LED current dimming driving the Out pin via the MOSFET switch to ground. The Out pin current is then effectively switched on and off causing the LED current to turn on and off

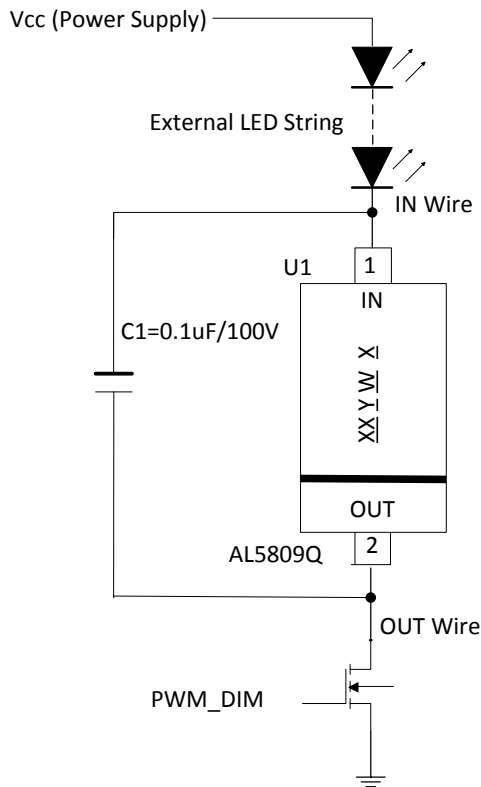

(a) PWM Dimming by External MOSFET

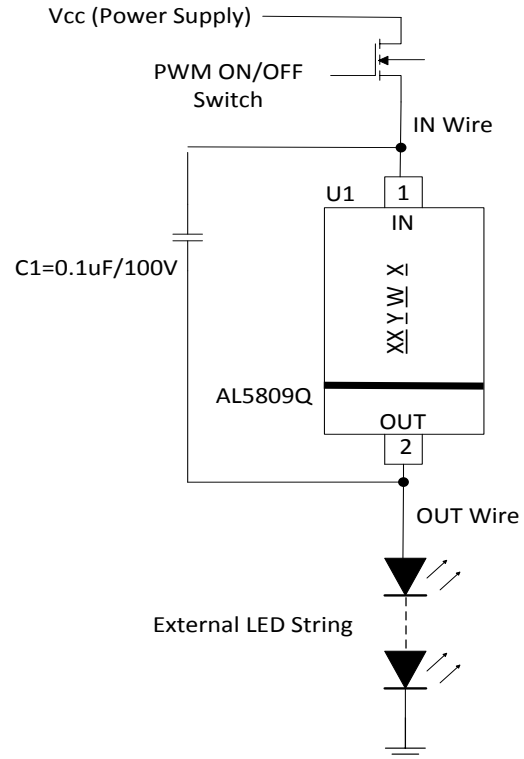

(b) PWM Dimming by Power Supply VIN ON/OFF

1. The evaluation board can be configured as Low side current LED configuration with use of PWM dimming.
2. Ensure that the DC source is switched OFF or disconnected.
3. Connect the power supply to Anode terminal of external LED string in the Low side LED configuration.
4. Connect the Cathode terminals of external LED string to IN terminal of the board and connect OUT wire to GND.
5. Insert external MOSFET across OUT terminal and GND of the board for PWM dimming control.
6. Ensure that the area around the board is clear and safe, and preferably that the board and LEDs are enclosed in a transparent safety cover.
7. Turn on the main switch. LED string should light up and the LED current should be regulated according to the current options of the device.

Typical Performance Curves - 15mA, 20mA, 30mA, 40mA, and 50mA PDI123

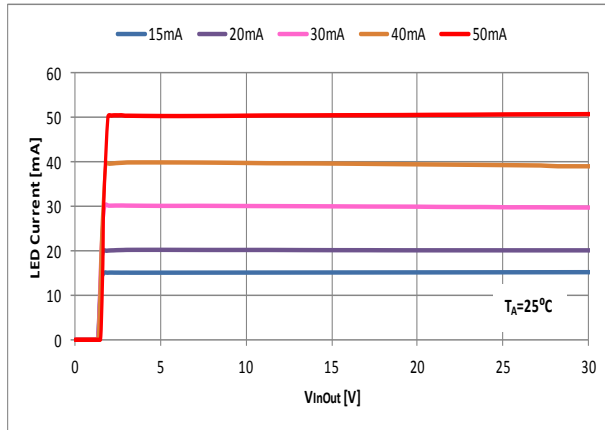

Figure 1. LED Current vs. VInOut

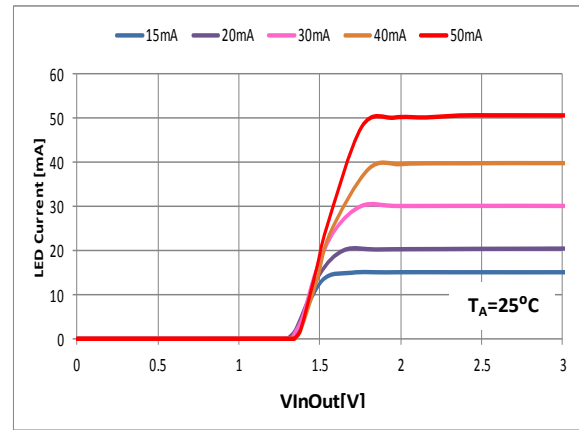

Figure 2. Startup Minimum Operating Voltage

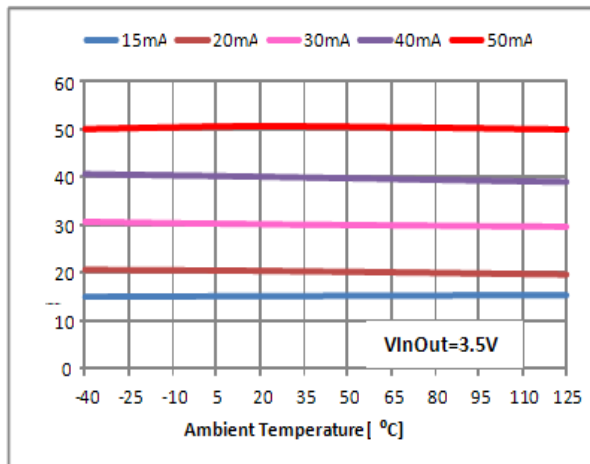

Figure 3. LED Current vs. Ambient Temperature

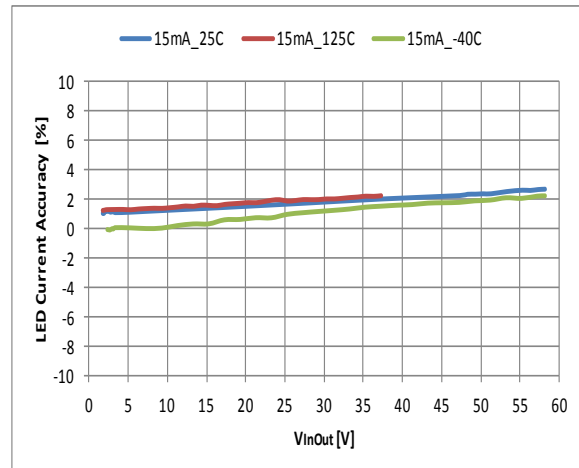

Figure 4 LED Current Accuracy (%) vs. VInOut across Temp

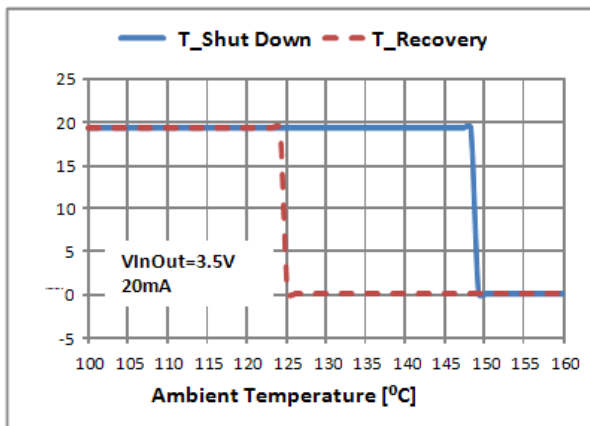

Figure 5. THSD of 20mA Current Option

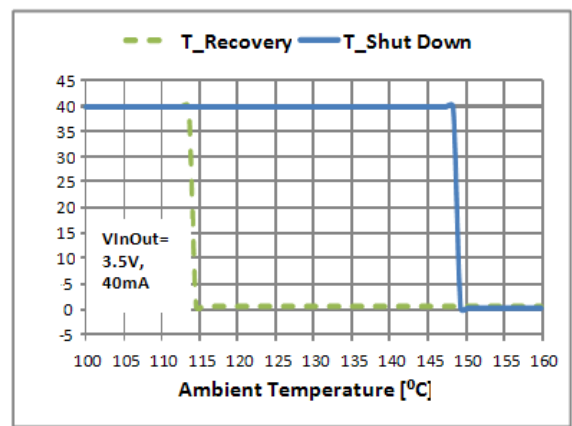

Figure 6. THSD of 40mA Current Option

Typical Performance Curves- 60mA, 90mA, and 150mA PDI123

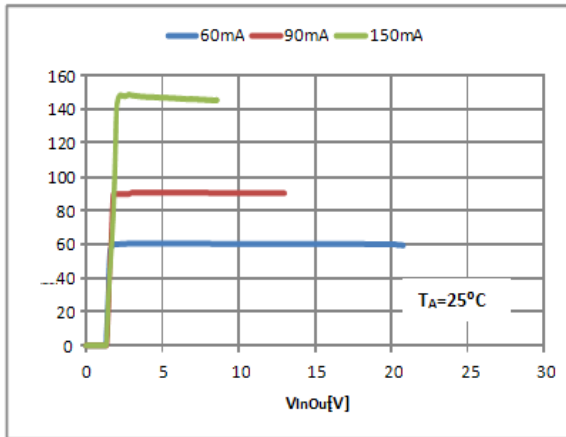

Figure 7. LED Current vs. VinOut

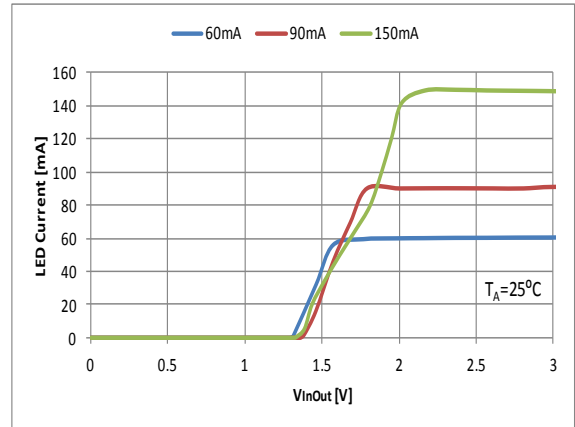

Figure 8. Startup Minimum Operating Voltage

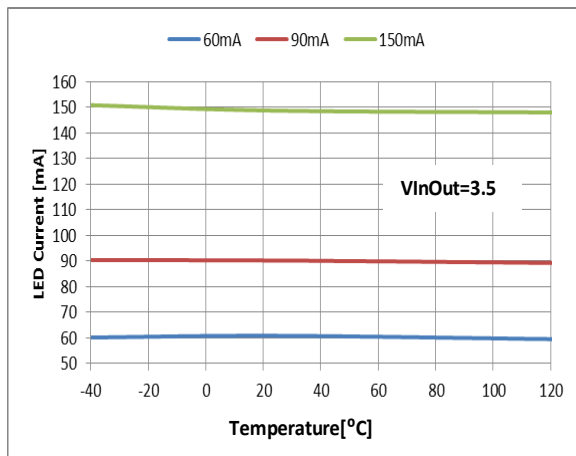

Figure 9. LED Current vs. Ambient Temperature

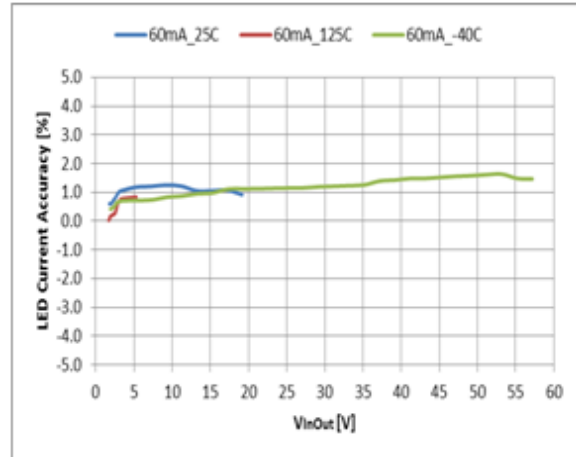

Figure 10 LED Current Accuracy (%) vs. VinOut across Temp

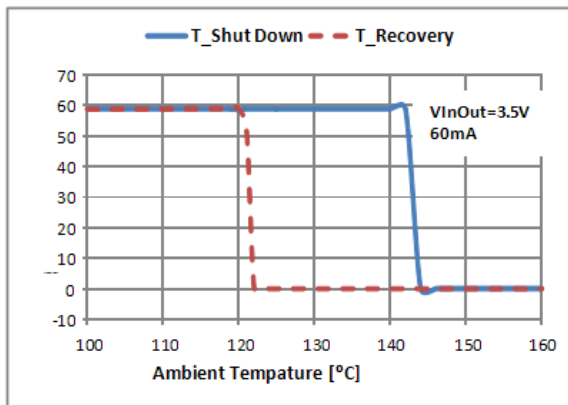

Figure 11. THSD of 20mA Current Option

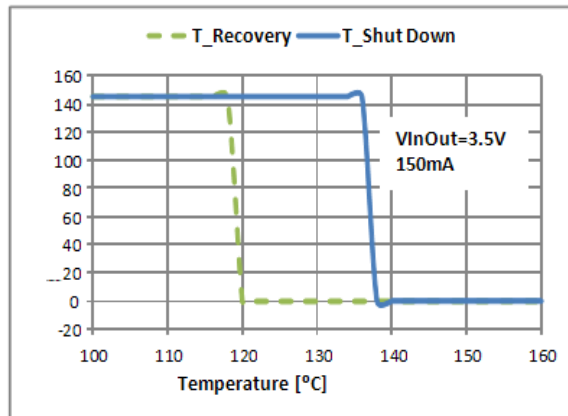

Figure 12. THSD of 40mA Current Option

Typical Performance Characteristics

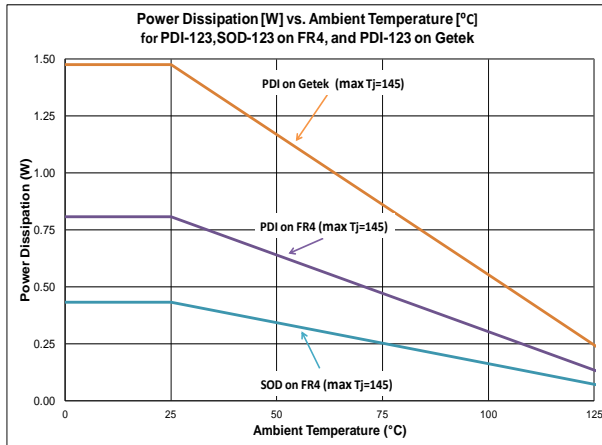

Figure 13. Power Dissipation vs. Ambient Temperature @ T_J = 160°C

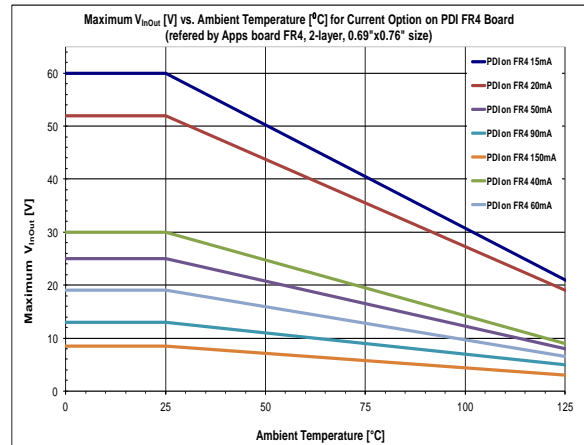

Figure 14. Maximum V_{inOut} vs. Temperature

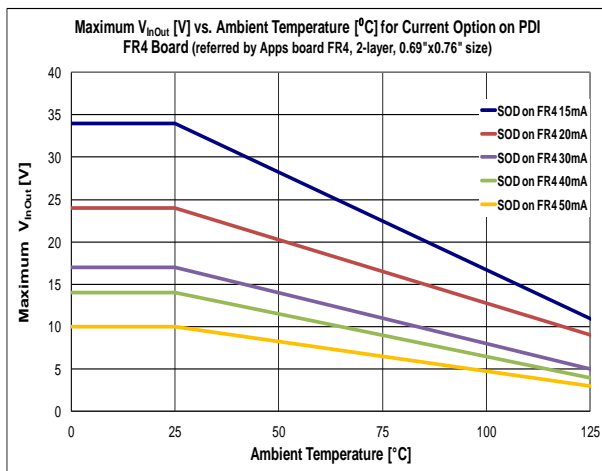

Figure 15. Maximum V_{inOut} vs. Temperature

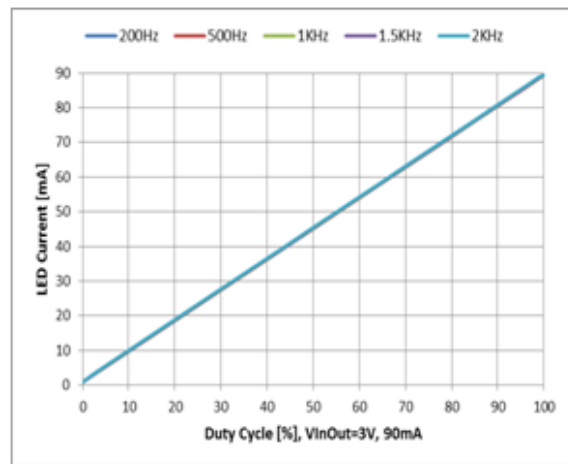

Figure 16 PWM Dimming 90mA vs. Duty Cycle

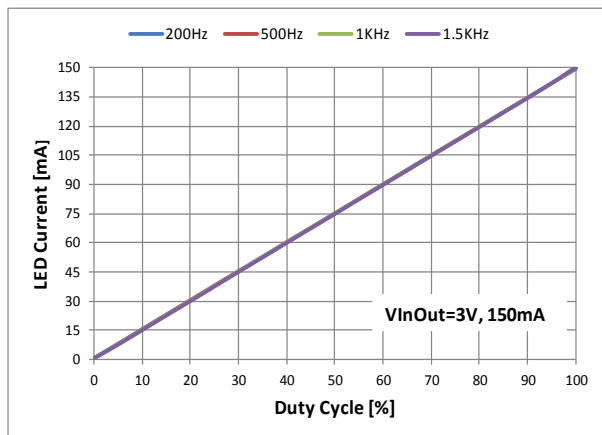

Figure 17. PWM Dimming 150mA vs. Duty Cycle

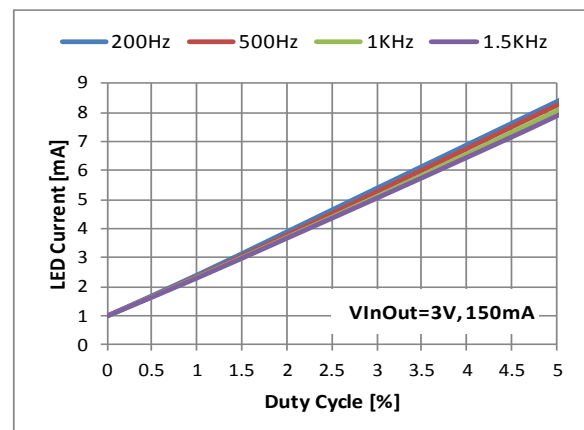

Figure 18. Area Zoom In within Duty Cycle 5% of Figure 17

IMPORTANT NOTICE

DIODE INCORPORATED MAKES NO WARRANTY OF ANY KIND, EXPRESS OR IMPLIED, WITH REGARDS TO THIS DOCUMENT, INCLUDING, BUT NOT LIMITED TO, THE IMPLIED WARRANTIES OF MERCHANTABILITY AND FITNESS FOR A PARTICULAR PURPOSE (AND THEIR EQUIVALENTS UNDER THE LAWS OF ANY JURISDICTION).

Diodes Incorporated and its subsidiaries reserve the right to make modifications, enhancements, improvements, corrections or other changes without further notice to this document and any product described herein. Diodes Incorporated does not assume any liability arising out of the application or use of this document or any product described herein; neither does Diodes Incorporated convey any license under its patent or trademark rights, nor the rights of others. Any Customer or user of this document or products described herein in such applications shall assume all risks of such use and will agree to hold Diodes Incorporated and all the companies whose products are represented on Diodes Incorporated website, harmless against all damages.

Diodes Incorporated does not warrant or accept any liability whatsoever in respect of any products purchased through unauthorized sales channel.

Should Customers purchase or use Diodes Incorporated products for any unintended or unauthorized application, Customers shall indemnify and hold Diodes Incorporated and its representatives harmless against all claims, damages, expenses, and attorney fees arising out of, directly or indirectly, any claim of personal injury or death associated with such unintended or unauthorized application.

Products described herein may be covered by one or more United States, international or foreign patents pending. Product names and markings noted herein may also be covered by one or more United States, international or foreign trademarks.

This document is written in English but may be translated into multiple languages for reference. Only the English version of this document is the final and determinative format released by Diodes Incorporated.

LIFE SUPPORT

Diodes Incorporated products are specifically not authorized for use as critical components in life support devices or systems without the express written approval of the Chief Executive Officer of Diodes Incorporated. As used herein:

A. Life support devices or systems are devices or systems which:

1. Are intended to implant into the body, or

2. Support or sustain life and whose failure to perform when properly used in accordance with instructions for use provided in the labeling can be reasonably expected to result in significant injury to the user.

B. A critical component is any component in a life support device or system whose failure to perform can be reasonably expected to cause the failure of the life support device or to affect its safety or effectiveness.

Customers represent that they have all necessary expertise in the safety and regulatory ramifications of their life support devices or systems, and acknowledge and agree that they are solely responsible for all legal, regulatory and safety-related requirements concerning their products and any use of Diodes Incorporated products in such safety-critical, life support devices or systems, notwithstanding any devices- or systems-related information or support that may be provided by Diodes Incorporated. Further, Customers must fully indemnify Diodes Incorporated and its representatives against any damages arising out of the use of Diodes Incorporated products in such safety-critical, life support devices or systems.

Copyright © 2018, Diodes Incorporated

www.diodes.com

Компания «Океан Электроники» предлагает заключение долгосрочных отношений при поставках импортных электронных компонентов на взаимовыгодных условиях!

Наши преимущества:

- Поставка оригинальных импортных электронных компонентов напрямую с производств Америки, Европы и Азии, а так же с крупнейших складов мира;
- Широкая линейка поставок активных и пассивных импортных электронных компонентов (более 30 млн. наименований);
- Поставка сложных, дефицитных, либо снятых с производства позиций;
- Оперативные сроки поставки под заказ (от 5 рабочих дней);
- Экспресс доставка в любую точку России;
- Помощь Конструкторского Отдела и консультации квалифицированных инженеров;
- Техническая поддержка проекта, помощь в подборе аналогов, поставка прототипов;
- Поставка электронных компонентов под контролем ВП;
- Система менеджмента качества сертифицирована по Международному стандарту ISO 9001;
- При необходимости вся продукция военного и аэрокосмического назначения проходит испытания и сертификацию в лаборатории (по согласованию с заказчиком);
- Поставка специализированных компонентов военного и аэрокосмического уровня качества (Xilinx, Altera, Analog Devices, Intersil, Interpoint, Microsemi, Actel, Aeroflex, Peregrine, VPT, Syfer, Eurofarad, Texas Instruments, MS Kennedy, Miteq, Cobham, E2V, MA-COM, Hittite, Mini-Circuits, General Dynamics и др.);

Компания «Океан Электроники» является официальным дистрибьютором и эксклюзивным представителем в России одного из крупнейших производителей разъемов военного и аэрокосмического назначения «JONHON», а так же официальным дистрибьютором и эксклюзивным представителем в России производителя высокотехнологичных и надежных решений для передачи СВЧ сигналов «FORSTAR».



JONHON

«JONHON» (основан в 1970 г.)

Разъемы специального, военного и аэрокосмического назначения:

(Применяются в военной, авиационной, аэрокосмической, морской, железнодорожной, горно- и нефтедобывающей отраслях промышленности)

«FORSTAR» (основан в 1998 г.)

ВЧ соединители, коаксиальные кабели, кабельные сборки и микроволновые компоненты:

(Применяются в телекоммуникациях гражданского и специального назначения, в средствах связи, РЛС, а так же военной, авиационной и аэрокосмической отраслях промышленности).



Телефон: 8 (812) 309-75-97 (многоканальный)

Факс: 8 (812) 320-03-32

Электронная почта: ocean@oceanchips.ru

Web: <http://oceanchips.ru/>

Адрес: 198099, г. Санкт-Петербург, ул. Калинина, д. 2, корп. 4, лит. А