

NCS20071, NCV20071, NCS20072, NCV20072, NCS20074, NCV20074

Operational Amplifier, Rail-to-Rail Output, 3 MHz BW

The NCx2007x series operational amplifiers provide rail-to-rail output operation, 3 MHz bandwidth, and are available in single, dual, and quad configurations. Rail-to-rail operation enables the user to make optimal use of the entire supply voltage range while taking advantage of 3 MHz bandwidth. The NCx2007x can operate on supply voltages as low as 2.7 V over the temperature range of -40°C to 125°C . At a 2.7 V supply, the high bandwidth provides a slew rate of $2.8\text{ V}/\mu\text{s}$ while only consuming $405\ \mu\text{A}$ of quiescent current per channel. The wide supply range allows the NCx2007x to run on supply voltages as high as 36 V, making it ideal for a broad range of applications. Since this is a CMOS device, high input impedance and low bias currents make it ideal for interfacing to a wide variety of signal sensors. The NCx2007x devices are available in a variety of compact packages. Automotive qualified options are available under the NCV prefix.

Features

- Rail-To-Rail Output
- Wide Supply Range: 2.7 V to 36 V
- Wide Bandwidth: 3 MHz typical at $V_S = 2.7\text{ V}$
- High Slew Rate: $2.8\text{ V}/\mu\text{s}$ typical at $V_S = 2.7\text{ V}$
- Low Supply Current: $405\ \mu\text{A}$ per channel at $V_S = 2.7\text{ V}$
- Low Input Bias Current: 5 pA typical
- Wide Temperature Range: -40°C to 125°C
- Available in a variety of packages
- NCV Prefix for Automotive and Other Applications Requiring Unique Site and Control Change Requirements; AEC-Q100 Qualified and PPAP Capable
- These Devices are Pb-Free, Halogen Free/BFR Free and are RoHS Compliant

Applications

- Current Sensing
- Signal Conditioning
- Automotive

End Products

- Notebook Computers
- Portable Instruments
- Power Supplies

This document contains information on some products that are still under development. ON Semiconductor reserves the right to change or discontinue these products without notice.



ON Semiconductor®

www.onsemi.com



SOT-553
CASE 463B

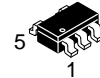

TSOP-5
CASE 483



Micro8™
CASE 846A

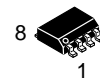

SOIC-8
CASE 751



TSSOP-8
CASE 948S

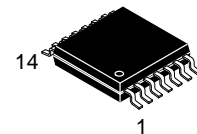

TSSOP-14
CASE 948G

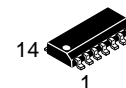

SOIC-14 NB
CASE 751A

DEVICE MARKING INFORMATION

See general marking information in the device marking section on page 2 of this data sheet.

ORDERING INFORMATION

See detailed ordering and shipping information on page 4 of this data sheet.

MARKING DIAGRAMS

Single Channel Configuration
NCS20071, NCV20071



SOT-553
CASE 463B

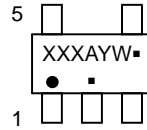

TSOP-5
CASE 483

Dual Channel Configuration
NCS20072, NCV20072

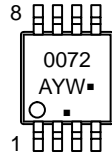

Micro8™
CASE 846A

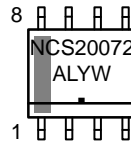

SOIC-8
CASE 751

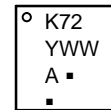

TSSOP-8
CASE 948S

Quad Channel Configuration
NCS20074, NCV20074

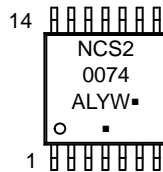

TSSOP-14
CASE 948G

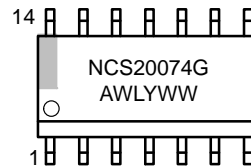

SOIC-14 NB
CASE 751A

- XXXXX = Specific Device Code
- A = Assembly Location
- WL, L = Wafer Lot
- Y = Year
- WW, W = Work Week
- G or ■ = Pb-Free Package

(Note: Microdot may be in either location)

NCS20071, NCV20071, NCS20072, NCV20072, NCS20074, NCV20074

Single Channel Configuration
NCS20071, NCV20071

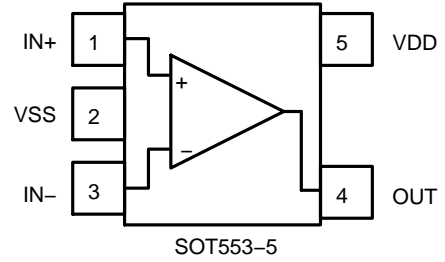
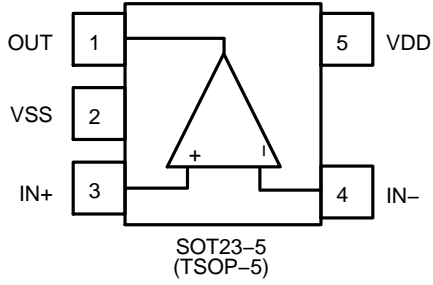

Dual Channel Configuration
NCS20072, NCV20072

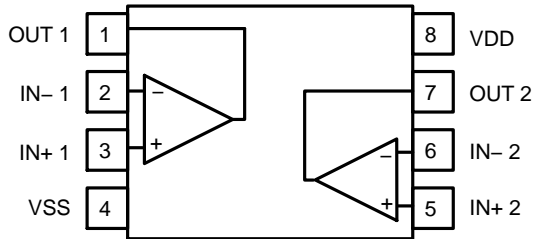

Quadruple Channel Configuration
NCS20074, NCV20074

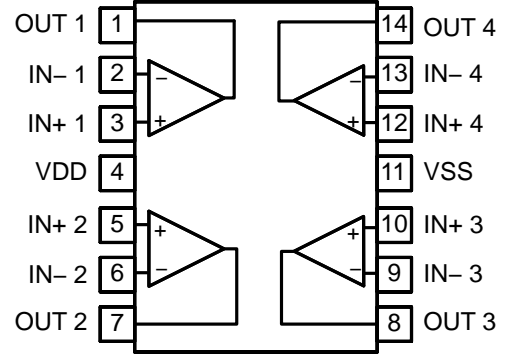

Figure 1. Pin Connections

NCS20071, NCV20071, NCS20072, NCV20072, NCS20074, NCV20074

ORDERING INFORMATION

| Device | Configuration | Automotive | Marking | Package | Shipping† |
|--|---------------|------------|--------------|-----------------------------|----------------------|
| NCS20071SN2T1G (In Development)** | Single | No | TBD | TSOP-5 (Pb-Free) | 3000 / Tape and Reel |
| NCS20071XV53T2G (In Development)** | | | TBD | SOT553-5 (Pb-Free) | 4000 / Tape and Reel |
| NCV20071SN2T1G* (In Development)** | | Yes | TBD | TSOP-5 (Pb-Free) | 3000 / Tape and Reel |
| NCV20071XV53T2G* (In Development)** | | | TBD | SOT553-5 (Pb-Free) | 4000 / Tape and Reel |
| NCS20072DMR2G | Dual | No | 0072 | Micro8 (MSOP8) (Pb-Free) | 4000 / Tape and Reel |
| NCS20072DR2G | | | NCS20072 | SOIC-8 (Pb-Free) | 2500 / Tape and Reel |
| NCS20072DTBR2G | | | K72 | TSSOP-8 (Pb-Free) | 2500 / Tape and Reel |
| NCV20072DMR2G* | | Yes | 0072 | Micro8 (MSOP8) (Pb-Free) | 4000 / Tape and Reel |
| NCV20072DR2G* | | | NCS20072 | SOIC-8 (Pb-Free) | 2500 / Tape and Reel |
| NCV20072DTBR2G* | | | K72 | TSSOP-8 (Pb-Free) | 2500 / Tape and Reel |
| NCS20074DR2G | Quad | No | NCS20074 | SOIC-14 (Pb-Free) | 2500 / Tape and Reel |
| NCS20074DTBR2G | | | NCS2 0074 | TSSOP-14 (Pb-Free) | 2500 / Tape and Reel |
| NCV20074DR2G* | | Yes | NCS20074 | SOIC-14 (Pb-Free) | 2500 / Tape and Reel |
| NCV20074DTBR2G* | | | NCS2 0074 | TSSOP-14 (Pb-Free) | 2500 / Tape and Reel |

†For information on tape and reel specifications, including part orientation and tape sizes, please refer to our Tape and Reel Packaging Specifications Brochure, BRD8011/D.

*NCV Prefix for Automotive and Other Applications Requiring Unique Site and Control Change Requirements; AEC-Q100 Qualified and PPAP Capable.

**Contact local sales office for availability.

NCS20071, NCV20071, NCS20072, NCV20072, NCS20074, NCV20074

ABSOLUTE MAXIMUM RATINGS (Note 1)

| Rating | Symbol | Limit | Unit | |
|--|--|----------------------------------|-----------|---|
| Supply Voltage ($V_{DD} - V_{SS}$) (Note 2) | V_S | 40 | V | |
| Input Voltage | V_{CM} | $V_{SS} - 0.2$ to $V_{DD} + 0.2$ | V | |
| Differential Input Voltage | V_{ID} | $\pm V_S$ | V | |
| Maximum Input Current | I_{IN} | ± 10 | mA | |
| Maximum Output Current | I_O | ± 100 | mA | |
| Continuous Total Power Dissipation (Note 2) | P_D | 200 | mW | |
| Maximum Junction Temperature | T_J | 150 | °C | |
| Storage Temperature Range | T_{STG} | -65 to 150 | °C | |
| Mounting Temperature (Infrared or Convection – 20 sec) | T_{mount} | 260 | °C | |
| ESD Capability (Note 3) | Human Body Model | HBM | 2000 | V |
| | Machine Model | MM | 150 | |
| | Charged Device Model – NCS20072/NCV20072 | CDM | 2000 (C6) | |
| | Charged Device Model – NCS20074/NCV20074 | CDM | 1000 (C6) | |
| Latch-Up Current (Note 4) | I_{LU} | 100 | mA | |
| Moisture Sensitivity Level (Note 5) | MSL | Level 1 | | |

Stresses exceeding those listed in the Maximum Ratings table may damage the device. If any of these limits are exceeded, device functionality should not be assumed, damage may occur and reliability may be affected.

1. Refer to ELECTRICAL CHARACTERISTICS and APPLICATION INFORMATION for Safe Operating Area.
2. Continuous short circuit operation to ground at elevated ambient temperature can result in exceeding the maximum allowed junction temperature of 150°C. Output currents in excess of the maximum output current rating over the long term may adversely affect reliability. Shorting output to either VDD or VSS will adversely affect reliability.
3. This device series incorporates ESD protection and is tested by the following methods:
ESD Human Body Model tested per ANSI/ANSI/ESDA/JEDEC JS-001-2010 (AEC-Q100-002)
ESD Machine Model tested per JESD22-A115 (AEC-Q100-003)
ESD Charged Device Model tested per ANSI/ESD S5.3.1-2009 (AEC-Q100-011)
4. Latch-up Current tested per JEDEC standard: JESD78 (AEC-Q100-004)
5. Moisture Sensitivity Level tested per IPC/JEDEC standard: J-STD-020A

THERMAL INFORMATION

| Parameter | Symbol | Package | Single Layer Board (Note 6) | Multi-Layer Board (Note 7) | Unit |
|---------------------|---------------|-----------------|-----------------------------|----------------------------|------|
| Junction-to-Ambient | θ_{JA} | SOT23-5 / TSOP5 | | | °C/W |
| | | SOT553-5 | | | |
| | | Micro8 / MSOP8 | 236 | 167 | |
| | | SOIC-8 | 190 | 131 | |
| | | TSSOP-8 | 253 | 194 | |
| | | SOIC-14 | 142 | 101 | |
| | | TSSOP-14 | 179 | 128 | |

6. Values based on a 1S standard PCB according to JEDEC51-3 with 1.0 oz copper and a 300 mm² copper area

7. Values based on a 1S2P standard PCB according to JEDEC51-7 with 1.0 oz copper and a 100 mm² copper area

OPERATING RANGES

| Parameter | Symbol | Min | Max | Unit |
|--|----------|------------|-----------------|------|
| Operating Supply Voltage (Single Supply) | V_S | 2.7 | 36 | V |
| Operating Supply Voltage (Split Supply) | V_S | ± 1.35 | ± 18 | V |
| Differential Input Voltage | V_{ID} | | V_S | V |
| Input Common Mode Voltage Range | V_{CM} | V_{SS} | $V_{DD} - 1.35$ | V |
| Ambient Temperature | T_A | -40 | 125 | °C |

Functional operation above the stresses listed in the Recommended Operating Ranges is not implied. Extended exposure to stresses beyond the Recommended Operating Ranges limits may affect device reliability.

NCS20071, NCV20071, NCS20072, NCV20072, NCS20074, NCV20074

ELECTRICAL CHARACTERISTICS AT $V_S = 2.7\text{ V}$

$T_A = 25^\circ\text{C}$; $R_L \geq 10\text{ k}\Omega$; $V_{CM} = V_{OUT} = \text{mid-supply}$ unless otherwise noted. All limits are guaranteed by testing or statistical analysis.

Boldface limits apply over the specified temperature range, $T_A = -40^\circ\text{C}$ to 125°C . (Notes 8, 9)

| Parameter | Symbol | Conditions | Min | Typ | Max | Unit |
|--------------------------------|--------------------------|---|----------|-----------|---------------------------|------------------------------|
| INPUT CHARACTERISTICS | | | | | | |
| Input Offset Voltage | V_{OS} | | | 1.3 | ± 3 | mV |
| | | | | | ± 4 | mV |
| Offset Voltage Drift | $\Delta V_{OS}/\Delta T$ | $T_A = 25^\circ\text{C}$ to 125°C | | 2 | | $\mu\text{V}/^\circ\text{C}$ |
| Input Bias Current (Note 9) | I_{IB} | | | 5 | 200 | pA |
| | | | | | 1500 | |
| Input Offset Current (Note 9) | I_{OS} | NCx20072 | | 2 | 75 | pA |
| | | | | | 500 | |
| | | NCx20074 | | 2 | 75 | |
| | | | | | 200 | |
| Channel Separation | XTLK | DC | NCx20072 | 100 | | dB |
| | | | NCx20074 | 115 | | |
| Differential Input Resistance | R_{ID} | | | 50 | | $\text{G}\Omega$ |
| Common Mode Input Resistance | R_{IN} | | | 5 | | $\text{G}\Omega$ |
| Differential Input Capacitance | C_{ID} | | | 1.5 | | pF |
| Common Mode Input Capacitance | C_{CM} | | | 3.5 | | pF |
| Common Mode Rejection Ratio | CMRR | NCx20072, $V_{CM} = V_{SS} + 0.2\text{ V}$ to $V_{DD} - 1.35\text{ V}$ | | 90 | 110 | dB |
| | | | | 69 | | |
| | | NCx20074, $V_{CM} = V_{SS}$ to $V_{DD} - 1.35\text{ V}$ | | 90 | 110 | |
| | | | | 69 | | |

OUTPUT CHARACTERISTICS

| | | | | | | |
|---------------------------|-----------|---|--|-----------|-------------|----|
| Open Loop Voltage Gain | A_{VOL} | | | 96 | 118 | dB |
| | | | | 86 | | |
| Output Current Capability | I_O | Op amp sinking current | | 70 | | mA |
| | | Op amp sourcing current | | 50 | | |
| Output Voltage High | V_{OH} | Voltage output swing from positive rail | | 0.006 | 0.15 | V |
| | | | | | 0.22 | |
| Output Voltage Low | V_{OL} | Voltage output swing from negative rail | | 0.005 | 0.15 | V |
| | | | | | 0.22 | |

AC CHARACTERISTICS

| | | | | | | |
|-------------------------|-------------|---|------------------------|-----|--|------------------------|
| Unity Gain Bandwidth | UGBW | $C_L = 25\text{ pF}$ | | 3 | | MHz |
| Slew Rate at Unity Gain | SR | $C_L = 20\text{ pF}$, $R_L = 2\text{ k}\Omega$ | | 2.8 | | $\text{V}/\mu\text{s}$ |
| Phase Margin | φ_m | $C_L = 25\text{ pF}$ | | 50 | | $^\circ$ |
| Gain Margin | A_m | $C_L = 25\text{ pF}$ | | 14 | | dB |
| Settling Time | t_s | $V_O = 1\text{ V}_{pp}$, Gain = 1, $C_L = 20\text{ pF}$ | Settling time to 0.1% | 0.6 | | μs |
| | | | Settling time to 0.01% | 1.2 | | |

Product parametric performance is indicated in the Electrical Characteristics for the listed test conditions, unless otherwise noted. Product performance may not be indicated by the Electrical Characteristics if operated under different conditions.

8. Refer to ABSOLUTE MAXIMUM RATINGS and APPLICATION INFORMATION for Safe Operating Area.

9. Performance guaranteed over the indicated operating temperature range by design and/or characterization.

NCS20071, NCV20071, NCS20072, NCV20072, NCS20074, NCV20074

ELECTRICAL CHARACTERISTICS AT $V_S = 2.7\text{ V}$

$T_A = 25^\circ\text{C}$; $R_L \geq 10\text{ k}\Omega$; $V_{CM} = V_{OUT} = \text{mid-supply}$ unless otherwise noted. All limits are guaranteed by testing or statistical analysis.
Boldface limits apply over the specified temperature range, $T_A = -40^\circ\text{C}$ to 125°C . (Notes 8, 9)

| Parameter | Symbol | Conditions | Min | Typ | Max | Unit |
|--------------------------------------|--------|---|-----|------|-----|------------------------------|
| NOISE CHARACTERISTICS | | | | | | |
| Total Harmonic Distortion plus Noise | THD+N | $V_{IN} = 0.5\text{ V}_{pp}$, $f = 1\text{ kHz}$, $A_v = 1$ | | 0.05 | | % |
| Input Referred Voltage Noise | e_n | $f = 1\text{ kHz}$ | | 30 | | $\text{nV}/\sqrt{\text{Hz}}$ |
| | | $f = 10\text{ kHz}$ | | 20 | | |
| Input Referred Current Noise | i_n | $f = 1\text{ kHz}$ | | 0.25 | | $\text{fA}/\sqrt{\text{Hz}}$ |

SUPPLY CHARACTERISTICS

| | | | | | | |
|--------------------------------|----------|----------------------|------------|-----|------------|---------------|
| Power Supply Rejection Ratio | PSRR | No Load | 114 | 135 | | dB |
| | | | 100 | | | |
| Power Supply Quiescent Current | I_{DD} | Per channel, no load | | 405 | 525 | μA |
| | | | | | 625 | |

Product parametric performance is indicated in the Electrical Characteristics for the listed test conditions, unless otherwise noted. Product performance may not be indicated by the Electrical Characteristics if operated under different conditions.

8. Refer to ABSOLUTE MAXIMUM RATINGS and APPLICATION INFORMATION for Safe Operating Area.

9. Performance guaranteed over the indicated operating temperature range by design and/or characterization.

ELECTRICAL CHARACTERISTICS AT $V_S = 5\text{ V}$

$T_A = 25^\circ\text{C}$; $R_L \geq 10\text{ k}\Omega$; $V_{CM} = V_{OUT} = \text{mid-supply}$ unless otherwise noted. All limits are guaranteed by testing or statistical analysis.
Boldface limits apply over the specified temperature range, $T_A = -40^\circ\text{C}$ to 125°C . (Notes 10, 11)

| Parameter | Symbol | Conditions | Min | Typ | Max | Unit |
|--------------------------------|--------------------------|---|-----------|-----|---------------------------|------------------------------|
| INPUT CHARACTERISTICS | | | | | | |
| Input Offset Voltage | V_{OS} | | | 1.3 | ± 3 | mV |
| | | | | | ± 4 | mV |
| Offset Voltage Drift | $\Delta V_{OS}/\Delta T$ | $T_A = 25^\circ\text{C}$ to 125°C | | 2 | | $\mu\text{V}/^\circ\text{C}$ |
| Input Bias Current (Note 11) | I_{IB} | | | 5 | 200 | pA |
| | | | | | 1500 | |
| Input Offset Current (Note 11) | I_{OS} | NCx20072 | | 2 | 75 | pA |
| | | | | | 500 | |
| | | NCx20074 | | 2 | 75 | |
| | | | | | 200 | |
| Channel Separation | XTLK | DC | NCx20072 | 100 | | dB |
| | | | NCx20074 | 115 | | |
| Differential Input Resistance | R_{ID} | | | 50 | | $\text{G}\Omega$ |
| Common Mode Input Resistance | R_{IN} | | | 5 | | $\text{G}\Omega$ |
| Differential Input Capacitance | C_{ID} | | | 1.5 | | pF |
| Common Mode Input Capacitance | C_{CM} | | | 3.5 | | pF |
| Common Mode Rejection Ratio | CMRR | NCx20072, $V_{CM} = V_{SS} + 0.2\text{ V}$ to $V_{DD} - 1.35\text{ V}$ | 102 | 125 | | dB |
| | | | 80 | | | |
| | | NCx20074, $V_{CM} = V_{SS}$ to $V_{DD} - 1.35\text{ V}$ | 105 | 125 | | |
| | | | 80 | | | |

Product parametric performance is indicated in the Electrical Characteristics for the listed test conditions, unless otherwise noted. Product performance may not be indicated by the Electrical Characteristics if operated under different conditions.

10. Refer to ABSOLUTE MAXIMUM RATINGS and APPLICATION INFORMATION for Safe Operating Area.

11. Performance guaranteed over the indicated operating temperature range by design and/or characterization.

NCS20071, NCV20071, NCS20072, NCV20072, NCS20074, NCV20074

ELECTRICAL CHARACTERISTICS AT $V_S = 5\text{ V}$

$T_A = 25^\circ\text{C}$; $R_L \geq 10\text{ k}\Omega$; $V_{CM} = V_{OUT} = \text{mid-supply}$ unless otherwise noted. All limits are guaranteed by testing or statistical analysis.

Boldface limits apply over the specified temperature range, $T_A = -40^\circ\text{C}$ to 125°C . (Notes 10, 11)

| Parameter | Symbol | Conditions | Min | Typ | Max | Unit |
|-----------|--------|------------|-----|-----|-----|------|
|-----------|--------|------------|-----|-----|-----|------|

OUTPUT CHARACTERISTICS

| | | | | | | |
|---------------------------|-----------|---|-----------|-------|-------------|----|
| Open Loop Voltage Gain | A_{VOL} | | 96 | 120 | | dB |
| | | | 86 | | | |
| Output Current Capability | I_O | Op amp sinking current | | 50 | | mA |
| | | Op amp sourcing current | | 60 | | |
| Output Voltage High | V_{OH} | Voltage output swing from positive rail | | 0.013 | 0.20 | V |
| | | | | | 0.25 | |
| Output Voltage Low | V_{OL} | Voltage output swing from negative rail | | 0.01 | 0.10 | V |
| | | | | | 0.15 | |

AC CHARACTERISTICS

| | | | | | | |
|-------------------------|-------------|---|------------------------|-----|--|------------------------|
| Unity Gain Bandwidth | UGBW | $C_L = 25\text{ pF}$ | | 3.2 | | MHz |
| Slew Rate at Unity Gain | SR | $C_L = 20\text{ pF}$, $R_L = 2\text{ k}\Omega$ | | 2.7 | | $\text{V}/\mu\text{s}$ |
| Phase Margin | φ_m | $C_L = 25\text{ pF}$ | | 50 | | $^\circ$ |
| Gain Margin | A_m | $C_L = 25\text{ pF}$ | | 14 | | dB |
| Settling Time | t_s | $V_O = 3\text{ V}_{pp}$, Gain = 1, $C_L = 20\text{ pF}$ | Settling time to 0.1% | 1.2 | | μs |
| | | | Settling time to 0.01% | 5.6 | | |

NOISE CHARACTERISTICS

| | | | | | | |
|--------------------------------------|-------|---|--|-------|--|------------------------------|
| Total Harmonic Distortion plus Noise | THD+N | $V_{IN} = 2.5\text{ V}_{pp}$, $f = 1\text{ kHz}$, $A_v = 1$ | | 0.009 | | % |
| Input Referred Voltage Noise | e_n | $f = 1\text{ kHz}$ | | 30 | | $\text{nV}/\sqrt{\text{Hz}}$ |
| | | $f = 10\text{ kHz}$ | | 20 | | |
| Input Referred Current Noise | i_n | $f = 1\text{ kHz}$ | | 0.25 | | $\text{fA}/\sqrt{\text{Hz}}$ |

SUPPLY CHARACTERISTICS

| | | | | | | |
|--------------------------------|----------|----------------------|------------|-----|------------|---------------|
| Power Supply Rejection Ratio | PSRR | No Load | 114 | 135 | | dB |
| | | | 100 | | | |
| Power Supply Quiescent Current | I_{DD} | Per channel, no load | | 410 | 530 | μA |
| | | | | | 630 | |

Product parametric performance is indicated in the Electrical Characteristics for the listed test conditions, unless otherwise noted. Product performance may not be indicated by the Electrical Characteristics if operated under different conditions.

10. Refer to ABSOLUTE MAXIMUM RATINGS and APPLICATION INFORMATION for Safe Operating Area.

11. Performance guaranteed over the indicated operating temperature range by design and/or characterization.

NCS20071, NCV20071, NCS20072, NCV20072, NCS20074, NCV20074

ELECTRICAL CHARACTERISTICS AT $V_S = 10\text{ V}$

$T_A = 25^\circ\text{C}$; $R_L \geq 10\text{ k}\Omega$; $V_{CM} = V_{OUT} = \text{mid-supply}$ unless otherwise noted. All limits are guaranteed by testing or statistical analysis. Boldface limits apply over the specified temperature range, $T_A = -40^\circ\text{C}$ to 125°C . (Notes 12, 13)

| Parameter | Symbol | Conditions | Min | Typ | Max | Unit |
|--------------------------------|--------------------------|---|----------|-----------|---------------------------|------------------------------|
| INPUT CHARACTERISTICS | | | | | | |
| Input Offset Voltage | V_{OS} | | | 1.3 | ± 3 | mV |
| | | | | | ± 4 | mV |
| Offset Voltage Drift | $\Delta V_{OS}/\Delta T$ | $T_A = 25^\circ\text{C}$ to 125°C | | 2 | | $\mu\text{V}/^\circ\text{C}$ |
| Input Bias Current (Note 13) | I_{IB} | | | 5 | 200 | pA |
| | | | | | 1500 | |
| Input Offset Current (Note 13) | I_{OS} | NCx20072 | | 2 | 75 | pA |
| | | | | | 500 | |
| | | NCx20074 | | 2 | 75 | |
| | | | | | 200 | |
| Channel Separation | XTLK | DC | NCx20072 | 100 | | dB |
| | | | NCx20074 | 115 | | |
| Differential Input Resistance | R_{ID} | | | 50 | | $\text{G}\Omega$ |
| Common Mode Input Resistance | R_{IN} | | | 5 | | $\text{G}\Omega$ |
| Differential Input Capacitance | C_{ID} | | | 1.5 | | pF |
| Common Mode Input Capacitance | C_{CM} | | | 3.5 | | pF |
| Common Mode Rejection Ratio | CMRR | NCx20072, $V_{CM} = V_{SS} + 0.2\text{ V}$ to $V_{DD} - 1.35\text{ V}$ | | 110 | 130 | dB |
| | | | | 87 | | |
| | | NCx20074, $V_{CM} = V_{SS}$ to $V_{DD} - 1.35\text{ V}$ | | 110 | 130 | |
| | | | | 87 | | |

OUTPUT CHARACTERISTICS

| | | | | | | |
|---------------------------|-----------|---|--|-----------|-------------|----|
| Open Loop Voltage Gain | A_{VOL} | | | 98 | 120 | dB |
| | | | | 88 | | |
| Output Current Capability | I_O | Op amp sinking current | | 50 | | mA |
| | | Op amp sourcing current | | 65 | | |
| Output Voltage High | V_{OH} | Voltage output swing from positive rail | | 0.023 | 0.08 | V |
| | | | | | 0.10 | |
| Output Voltage Low | V_{OL} | Voltage output swing from negative rail | | 0.022 | 0.3 | V |
| | | | | | 0.35 | |

AC CHARACTERISTICS

| | | | | | | |
|-------------------------|-------------|--|------------------------|-----|--|------------------------|
| Unity Gain Bandwidth | UGBW | $C_L = 25\text{ pF}$ | | 3.2 | | MHz |
| Slew Rate at Unity Gain | SR | $C_L = 20\text{ pF}$, $R_L = 2\text{ k}\Omega$ | | 2.2 | | $\text{V}/\mu\text{s}$ |
| Phase Margin | φ_m | $C_L = 25\text{ pF}$ | | 50 | | $^\circ$ |
| Gain Margin | A_m | $C_L = 25\text{ pF}$ | | 14 | | dB |
| Settling Time | t_s | $V_O = 8.5\text{ Vpp}$, Gain = 1, $C_L = 20\text{ pF}$ | Settling time to 0.1% | 3.4 | | μs |
| | | | Settling time to 0.01% | 6.8 | | |

Product parametric performance is indicated in the Electrical Characteristics for the listed test conditions, unless otherwise noted. Product performance may not be indicated by the Electrical Characteristics if operated under different conditions.

12. Refer to ABSOLUTE MAXIMUM RATINGS and APPLICATION INFORMATION for Safe Operating Area.

13. Performance guaranteed over the indicated operating temperature range by design and/or characterization.

NCS20071, NCV20071, NCS20072, NCV20072, NCS20074, NCV20074

ELECTRICAL CHARACTERISTICS AT $V_S = 10\text{ V}$

$T_A = 25^\circ\text{C}$; $R_L \geq 10\text{ k}\Omega$; $V_{CM} = V_{OUT} = \text{mid-supply}$ unless otherwise noted. All limits are guaranteed by testing or statistical analysis. Boldface limits apply over the specified temperature range, $T_A = -40^\circ\text{C}$ to 125°C . (Notes 12, 13)

| Parameter | Symbol | Conditions | Min | Typ | Max | Unit |
|--------------------------------------|--------|--|-----|-------|-----|------------------------------|
| NOISE CHARACTERISTICS | | | | | | |
| Total Harmonic Distortion plus Noise | THD+N | $V_{IN} = 7.5\text{ Vpp}$, $f = 1\text{ kHz}$, $A_v = 1$ | | 0.004 | | % |
| Input Referred Voltage Noise | e_n | $f = 1\text{ kHz}$ | | 30 | | $\text{nV}/\sqrt{\text{Hz}}$ |
| | | $f = 10\text{ kHz}$ | | 20 | | |
| Input Referred Current Noise | i_n | $f = 1\text{ kHz}$ | | 0.25 | | $\text{fA}/\sqrt{\text{Hz}}$ |

SUPPLY CHARACTERISTICS

| | | | | | | |
|--------------------------------|----------|----------------------|------------|-----|------------|---------------|
| Power Supply Rejection Ratio | PSRR | No Load | 114 | 135 | | dB |
| | | | 100 | | | |
| Power Supply Quiescent Current | I_{DD} | Per channel, no load | | 416 | 540 | μA |
| | | | | | 640 | |

Product parametric performance is indicated in the Electrical Characteristics for the listed test conditions, unless otherwise noted. Product performance may not be indicated by the Electrical Characteristics if operated under different conditions.

12. Refer to ABSOLUTE MAXIMUM RATINGS and APPLICATION INFORMATION for Safe Operating Area.

13. Performance guaranteed over the indicated operating temperature range by design and/or characterization.

ELECTRICAL CHARACTERISTICS AT $V_S = 36\text{ V}$

$T_A = 25^\circ\text{C}$; $R_L \geq 10\text{ k}\Omega$; $V_{CM} = V_{OUT} = \text{mid-supply}$ unless otherwise noted. All limits are guaranteed by testing or statistical analysis. Boldface limits apply over the specified temperature range, $T_A = -40^\circ\text{C}$ to 125°C . (Notes 14, 15)

| Parameter | Symbol | Conditions | Min | Typ | Max | Unit | |
|--------------------------------|--------------------------|---|----------|----------|---------------------------|------------------------------|-------------|
| INPUT CHARACTERISTICS | | | | | | | |
| Input Offset Voltage | V_{OS} | | | 1.3 | ± 3 | mV | |
| | | | | | ± 4 | mV | |
| Offset Voltage Drift | $\Delta V_{OS}/\Delta T$ | $T_A = 25^\circ\text{C}$ to 125°C | | 2 | | $\mu\text{V}/^\circ\text{C}$ | |
| Input Bias Current (Note 15) | I_{IB} | | | 5 | 200 | pA | |
| | | | NCx20072 | | | | 2000 |
| | | NCx20074 | | | 1500 | | |
| Input Offset Current (Note 15) | I_{OS} | | NCx20072 | | 2 | 75 | pA |
| | | | | | | 1000 | |
| | | | | NCx20074 | | 2 | |
| | | | | | 200 | | |
| Channel Separation | XTLK | DC | NCx20072 | | 100 | dB | |
| | | | NCx20074 | | 115 | | |
| Differential Input Resistance | R_{ID} | | | 50 | | $\text{G}\Omega$ | |
| Common Mode Input Resistance | R_{IN} | | | 5 | | $\text{G}\Omega$ | |
| Differential Input Capacitance | C_{ID} | | | 1.5 | | pF | |
| Common Mode Input Capacitance | C_{CM} | | | 3.5 | | pF | |

Product parametric performance is indicated in the Electrical Characteristics for the listed test conditions, unless otherwise noted. Product performance may not be indicated by the Electrical Characteristics if operated under different conditions.

14. Refer to ABSOLUTE MAXIMUM RATINGS and APPLICATION INFORMATION for Safe Operating Area.

15. Performance guaranteed over the indicated operating temperature range by design and/or characterization.

NCS20071, NCV20071, NCS20072, NCV20072, NCS20074, NCV20074

ELECTRICAL CHARACTERISTICS AT $V_S = 36\text{ V}$

$T_A = 25^\circ\text{C}$; $R_L \geq 10\text{ k}\Omega$; $V_{CM} = V_{OUT} = \text{mid-supply}$ unless otherwise noted. All limits are guaranteed by testing or statistical analysis. Boldface limits apply over the specified temperature range, $T_A = -40^\circ\text{C}$ to 125°C . (Notes 14, 15)

| Parameter | Symbol | Conditions | Min | Typ | Max | Unit |
|------------------------------|--------|---|-----------|-----|-----|------|
| INPUT CHARACTERISTICS | | | | | | |
| Common Mode Rejection Ratio | CMRR | NCx20072, $V_{CM} = V_{SS} + 0.2\text{ V}$ to $V_{DD} - 1.35\text{ V}$ | 120 | 145 | | dB |
| | | | 95 | | | |
| | | NCx20074, $V_{CM} = V_{SS}$ to $V_{DD} - 1.35\text{ V}$ | 120 | 145 | | |
| | | | 95 | | | |

| | | | | | | |
|-------------------------------|-----------|---|-----------|-------|-------------|----|
| OUTPUT CHARACTERISTICS | | | | | | |
| Open Loop Voltage Gain | A_{VOL} | | 98 | 120 | | dB |
| | | | 88 | | | |
| Output Current Capability | I_O | Op amp sinking current | | | 50 | mA |
| | | Op amp sourcing current | | | 65 | |
| Output Voltage High | V_{OH} | Voltage output swing from positive rail | | 0.074 | 0.10 | V |
| | | | NCx20072 | | 0.15 | |
| | | | NCx20074 | | 0.12 | |
| Output Voltage Low | V_{OL} | Voltage output swing from negative rail | | | 0.065 | V |
| | | | | | | |

| | | | | | | |
|---------------------------|-------------|---|--|------------------------|-----|------------------|
| AC CHARACTERISTICS | | | | | | |
| Unity Gain Bandwidth | UGBW | $C_L = 25\text{ pF}$ | | | 3.2 | MHz |
| Slew Rate at Unity Gain | SR | $C_L = 20\text{ pF}$, $R_L = 2\text{ k}\Omega$ | | | 2.4 | V/ μs |
| Phase Margin | φ_m | $C_L = 25\text{ pF}$ | | | 50 | $^\circ$ |
| Gain Margin | A_m | $C_L = 25\text{ pF}$ | | | 14 | dB |
| Settling Time | t_s | $V_O = 10\text{ Vpp}$, Gain = 1, $C_L = 20\text{ pF}$ | | Settling time to 0.1% | 3.2 | μs |
| | | | | Settling time to 0.01% | 6.8 | |

| | | | | | | |
|--------------------------------------|-------|---|--|--|-------|-----------------------|
| NOISE CHARACTERISTICS | | | | | | |
| Total Harmonic Distortion plus Noise | THD+N | $V_{IN} = 28.5\text{ Vpp}$, $f = 1\text{ kHz}$, $A_v = 1$ | | | 0.001 | % |
| Input Referred Voltage Noise | e_n | $f = 1\text{ kHz}$ | | | 30 | $nV/\sqrt{\text{Hz}}$ |
| | | $f = 10\text{ kHz}$ | | | 20 | |
| Input Referred Current Noise | i_n | $f = 1\text{ kHz}$ | | | 0.25 | $fA/\sqrt{\text{Hz}}$ |

| | | | | | | | |
|--------------------------------|----------|----------------------|--|------------|-----|---------------|------------|
| SUPPLY CHARACTERISTICS | | | | | | | |
| Power Supply Rejection Ratio | PSRR | No Load | | 114 | 135 | dB | |
| | | | | 100 | | | |
| Power Supply Quiescent Current | I_{DD} | Per channel, no load | | NCx20072 | | μA | |
| | | | | | 465 | | 570 |
| | | | | | | | 700 |
| | | | | NCx20074 | | | |
| | | | | 700 | | | |

Product parametric performance is indicated in the Electrical Characteristics for the listed test conditions, unless otherwise noted. Product performance may not be indicated by the Electrical Characteristics if operated under different conditions.

14. Refer to ABSOLUTE MAXIMUM RATINGS and APPLICATION INFORMATION for Safe Operating Area.

15. Performance guaranteed over the indicated operating temperature range by design and/or characterization.

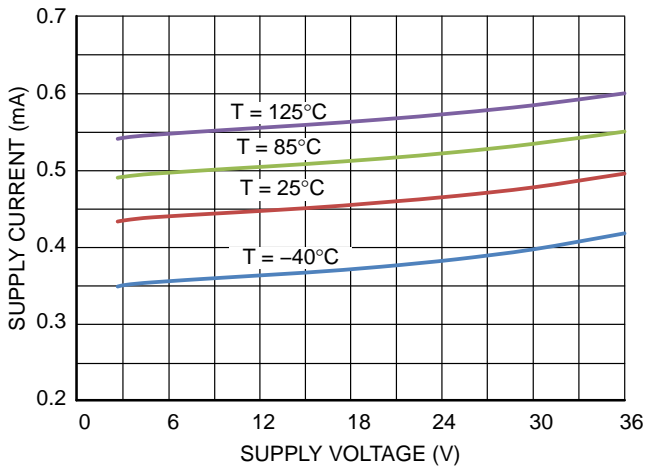

Figure 2. Quiescent Current Per Channel vs. Supply Voltage

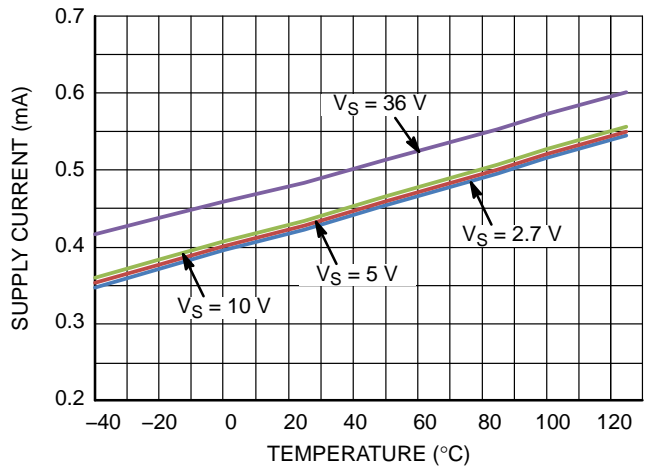

Figure 3. Quiescent Current vs. Temperature

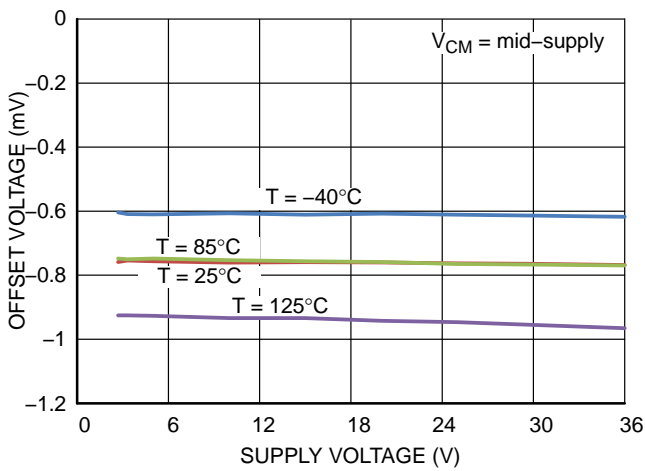

Figure 4. Offset Voltage vs. Supply Voltage

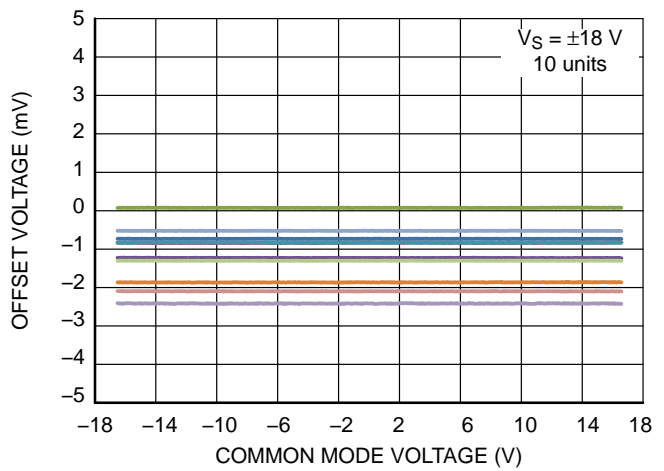

Figure 5. Input Offset Voltage vs. Common Mode Voltage

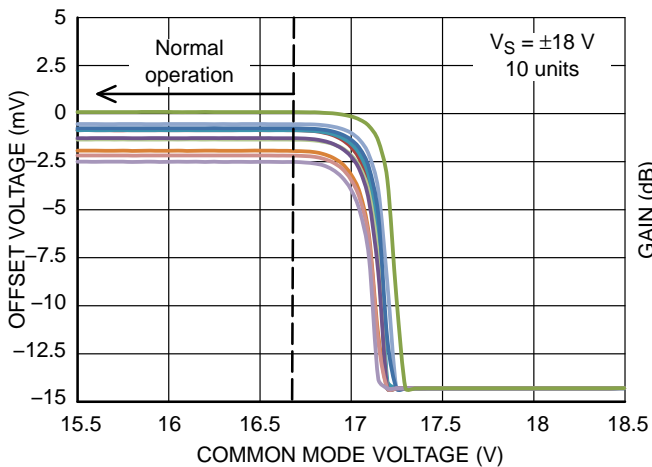

Figure 6. Input Offset Voltage vs. Common Mode Voltage

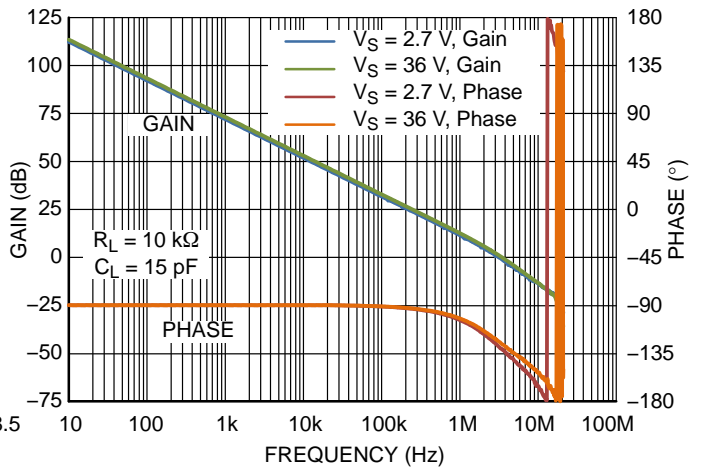

Figure 7. Gain and Phase vs. Frequency

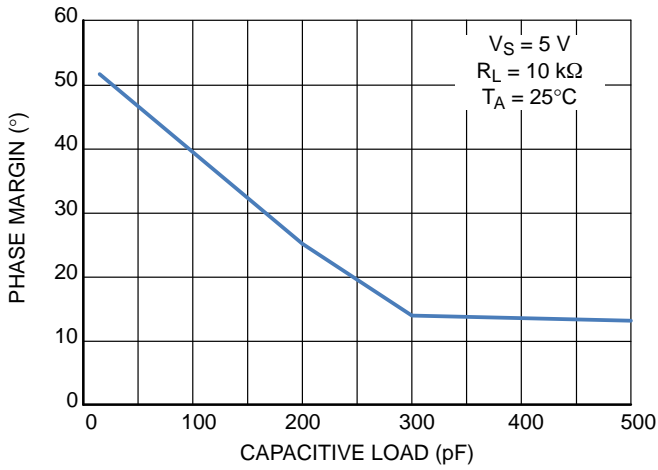

Figure 8. Phase Margin vs. Capacitive Load

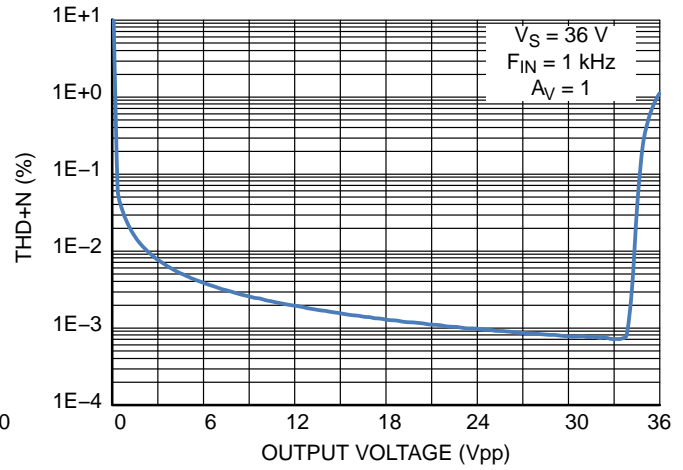

Figure 9. THD+N vs. Output Voltage

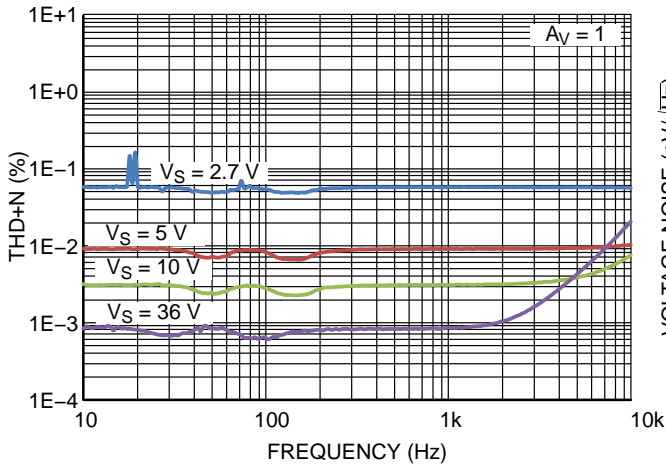

Figure 10. THD+N vs. Frequency

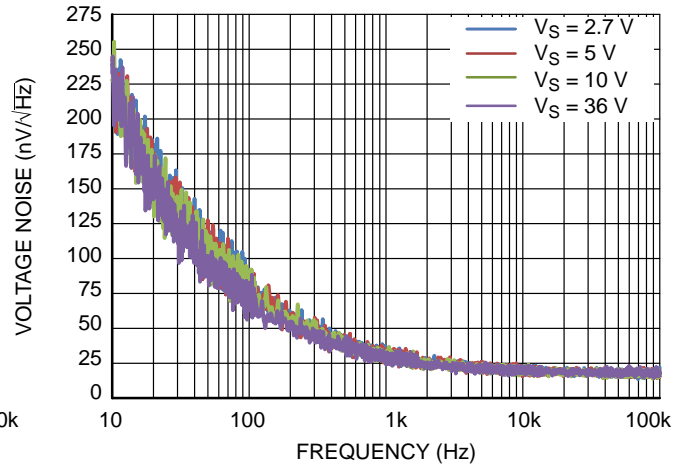

Figure 11. Input Voltage Noise vs. Frequency

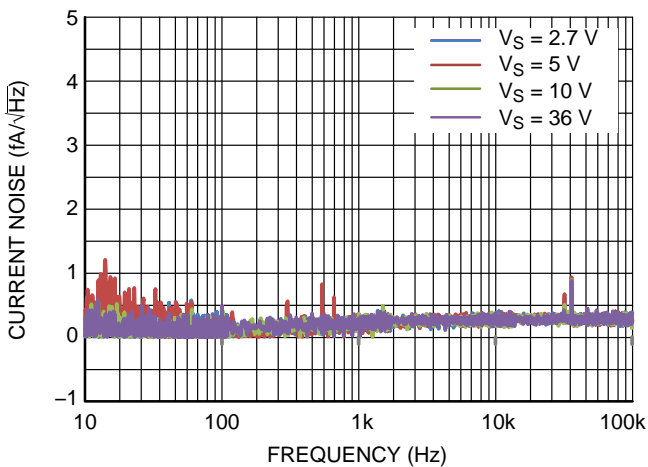

Figure 12. Input Current Noise vs. Frequency

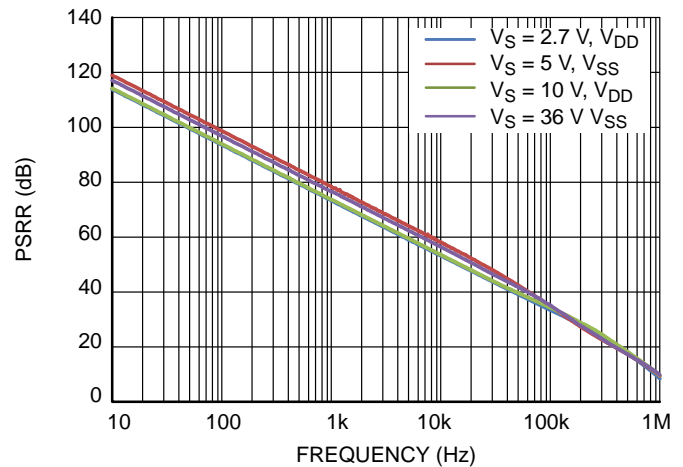

Figure 13. PSRR vs. Frequency

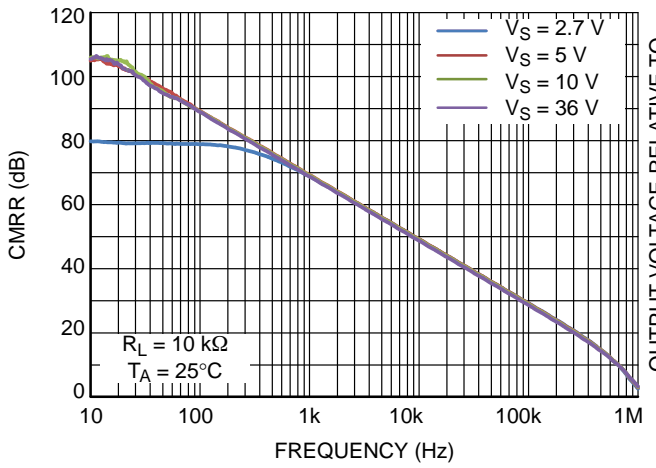

Figure 14. CMRR vs. Frequency

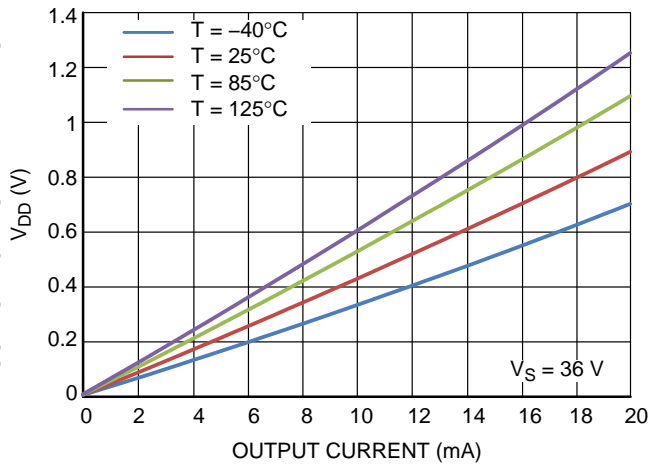

Figure 15. High Level Output vs. Output Current

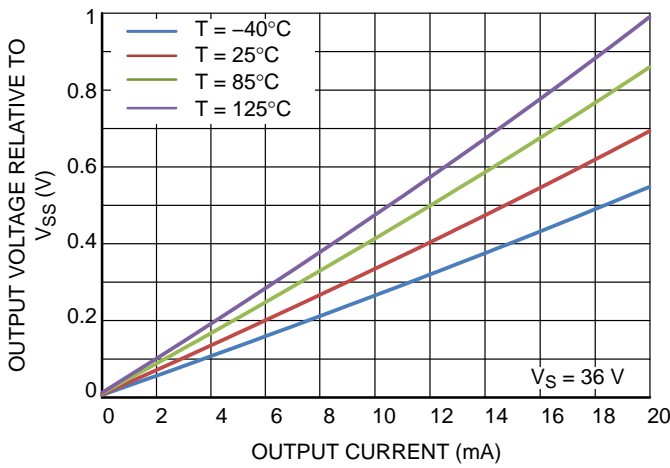

Figure 16. Low Level Output vs. Output Current

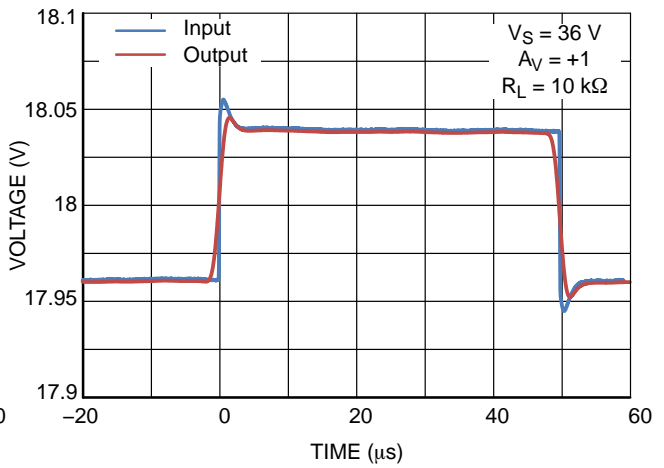

Figure 17. Non-inverting Small Signal Transient Response

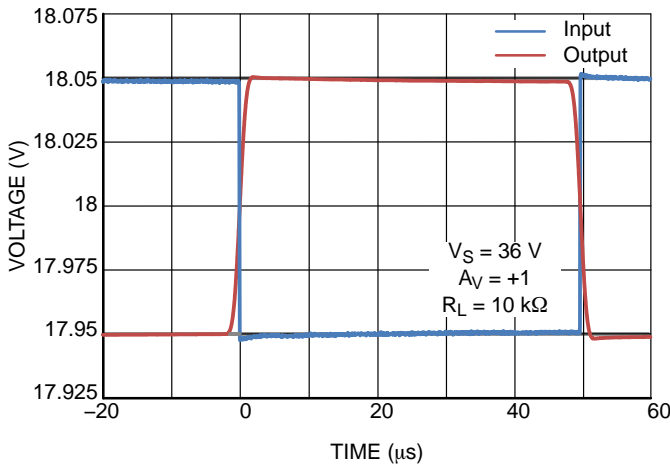

Figure 18. Inverting Small Signal Transient Response

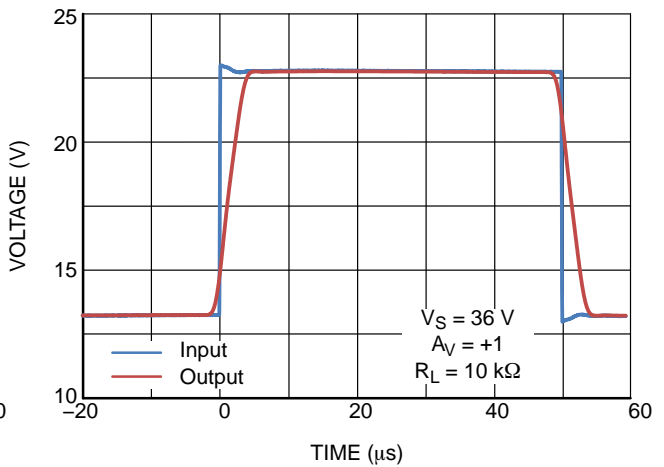

Figure 19. Non-inverting Large Signal Transient Response

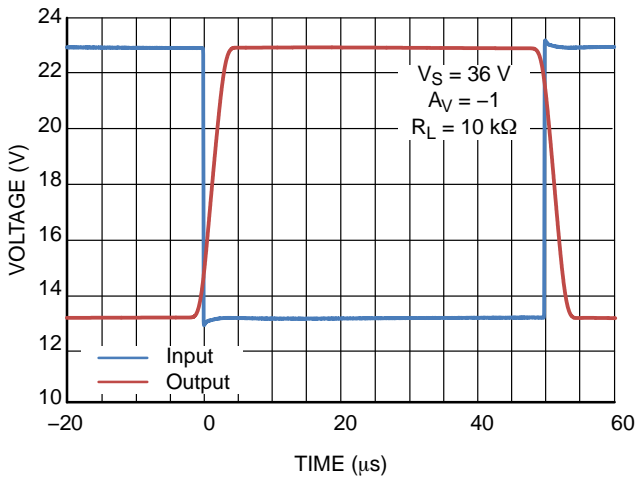

Figure 20. Inverting Large Signal Transient Response

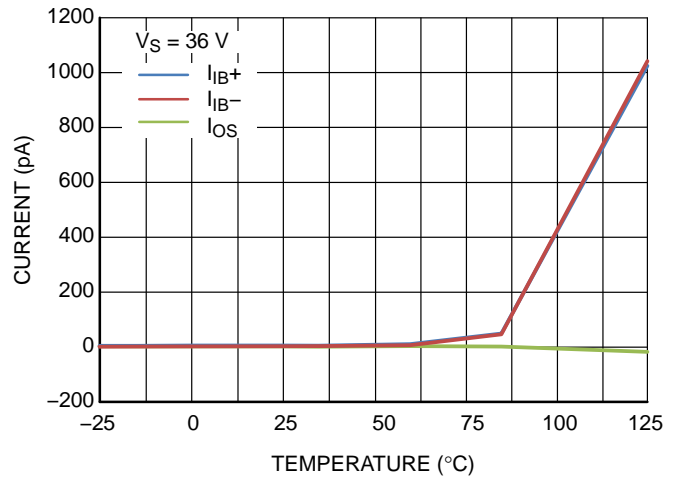

Figure 21. Input Bias and Offset Current vs. Temperature

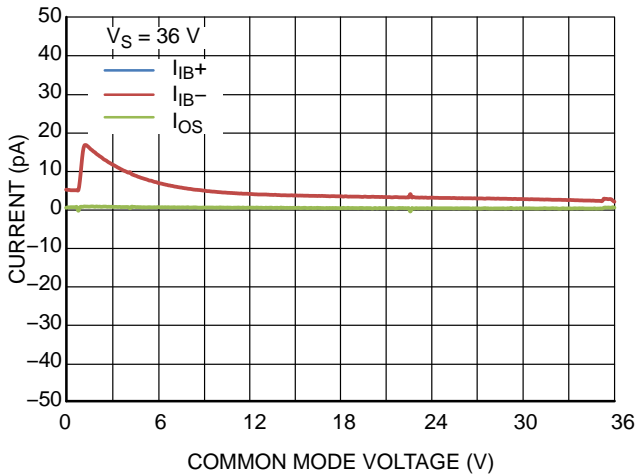

Figure 22. Input Bias Current vs. Common Mode Voltage

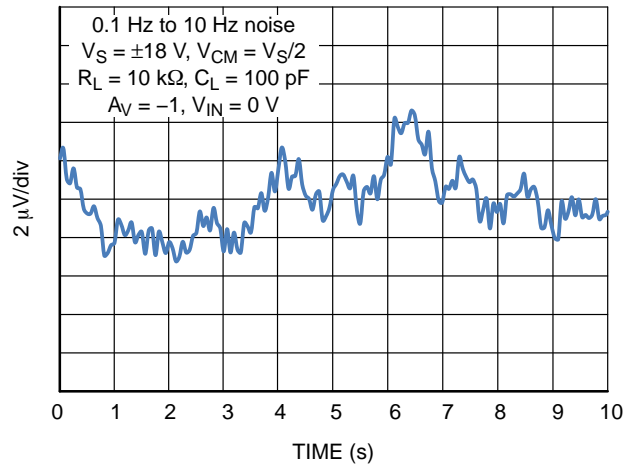

Figure 23. 0.1 Hz to 10 Hz Noise

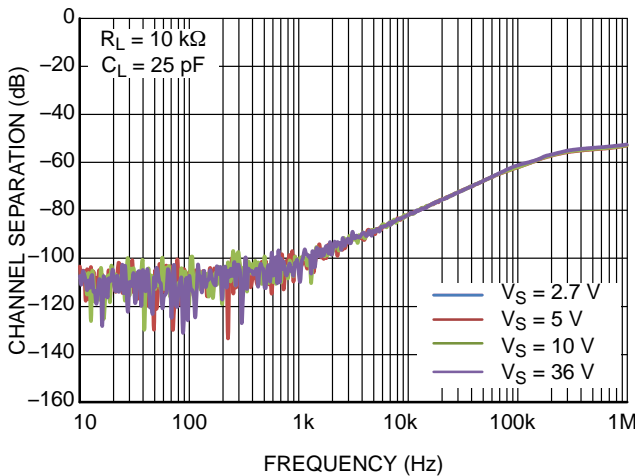

Figure 24. Channel Separation vs. Frequency

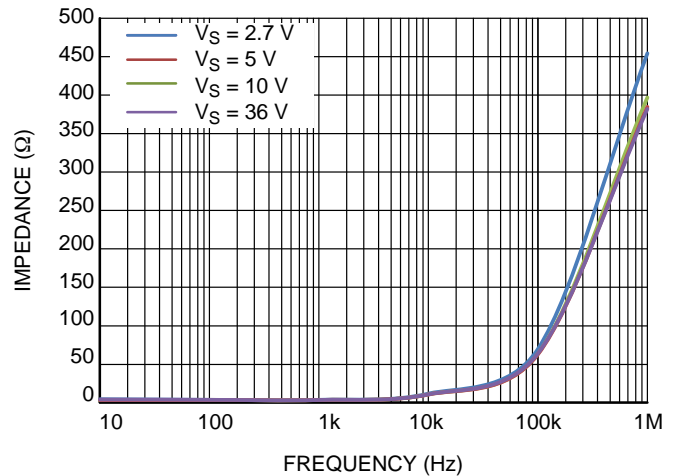

Figure 25. Open Loop Output Impedance

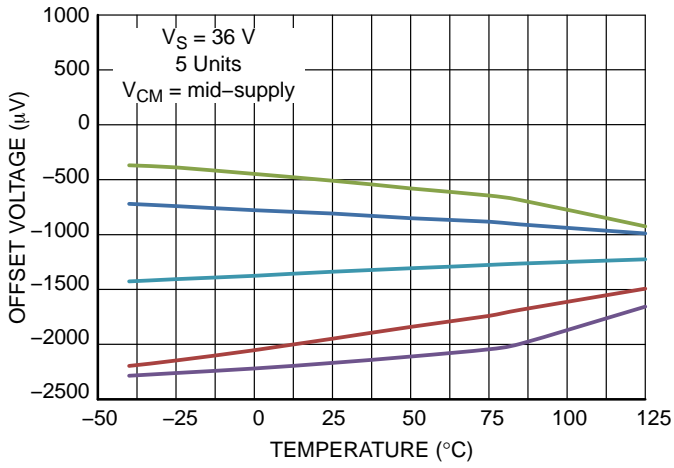

Figure 26. Offset Voltage vs. Temperature

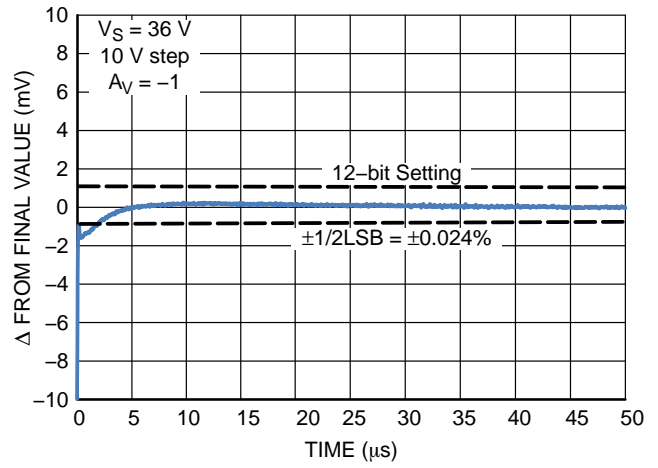

Figure 27. Large Signal Settling Time

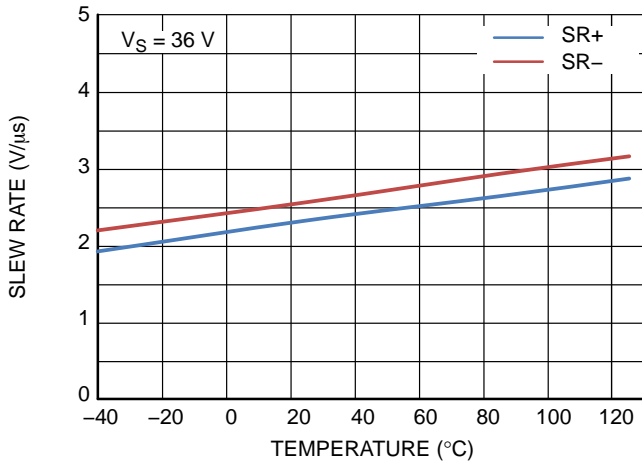
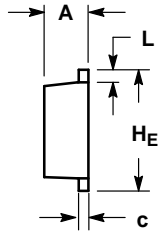
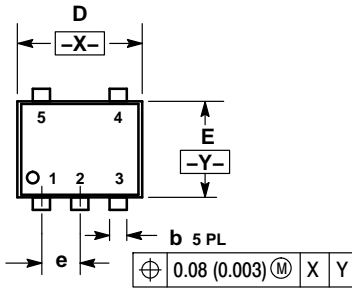

Figure 28. Slew Rate vs. Temperature

PACKAGE DIMENSIONS

SOT-553, 5 LEAD
CASE 463B
ISSUE C



NOTES:

1. DIMENSIONING AND TOLERANCING PER ANSI Y14.5M, 1982.
2. CONTROLLING DIMENSION: MILLIMETERS
3. MAXIMUM LEAD THICKNESS INCLUDES LEAD FINISH THICKNESS. MINIMUM LEAD THICKNESS IS THE MINIMUM THICKNESS OF BASE MATERIAL.

| DIM | MILLIMETERS | | | INCHES | | |
|-----|-------------|------|------|-----------|-------|-------|
| | MIN | NOM | MAX | MIN | NOM | MAX |
| A | 0.50 | 0.55 | 0.60 | 0.020 | 0.022 | 0.024 |
| b | 0.17 | 0.22 | 0.27 | 0.007 | 0.009 | 0.011 |
| c | 0.08 | 0.13 | 0.18 | 0.003 | 0.005 | 0.007 |
| D | 1.55 | 1.60 | 1.65 | 0.061 | 0.063 | 0.065 |
| E | 1.15 | 1.20 | 1.25 | 0.045 | 0.047 | 0.049 |
| e | 0.50 BSC | | | 0.020 BSC | | |
| L | 0.10 | 0.20 | 0.30 | 0.004 | 0.008 | 0.012 |
| HE | 1.55 | 1.60 | 1.65 | 0.061 | 0.063 | 0.065 |

RECOMMENDED
SOLDERING FOOTPRINT*

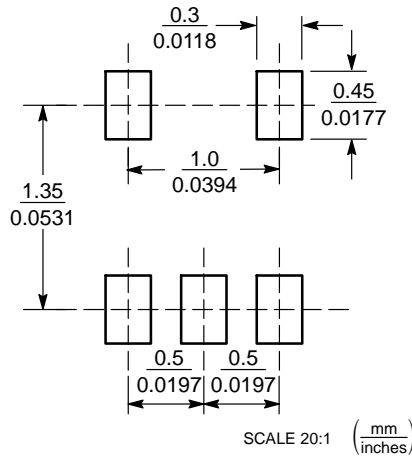

*For additional information on our Pb-Free strategy and soldering details, please download the ON Semiconductor Soldering and Mounting Techniques Reference Manual, SOLDERRM/D.

PACKAGE DIMENSIONS

TSOP-5
CASE 483-02
ISSUE K

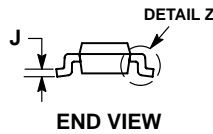
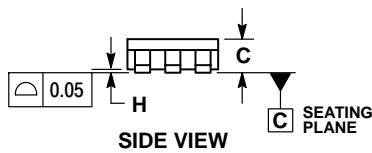
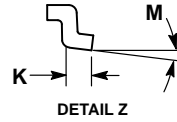
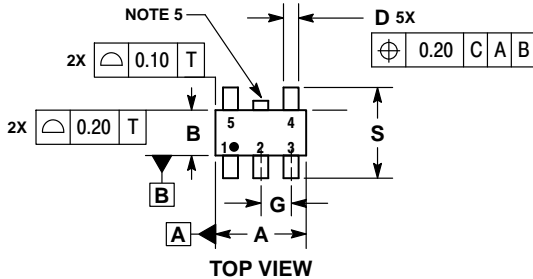

NOTES:

1. DIMENSIONING AND TOLERANCING PER ASME Y14.5M, 1994.
2. CONTROLLING DIMENSION: MILLIMETERS.
3. MAXIMUM LEAD THICKNESS INCLUDES LEAD FINISH THICKNESS. MINIMUM LEAD THICKNESS IS THE MINIMUM THICKNESS OF BASE MATERIAL.
4. DIMENSIONS A AND B DO NOT INCLUDE MOLD FLASH, PROTRUSIONS, OR GATE BURRS. MOLD FLASH, PROTRUSIONS, OR GATE BURRS SHALL NOT EXCEED 0.15 PER SIDE. DIMENSION A.
5. OPTIONAL CONSTRUCTION: AN ADDITIONAL TRIMMED LEAD IS ALLOWED IN THIS LOCATION. TRIMMED LEAD NOT TO EXTEND MORE THAN 0.2 FROM BODY.

| DIM | MILLIMETERS | |
|-----|-------------|------|
| | MIN | MAX |
| A | 3.00 BSC | |
| B | 1.50 BSC | |
| C | 0.90 | 1.10 |
| D | 0.25 | 0.50 |
| G | 0.95 BSC | |
| H | 0.01 | 0.10 |
| J | 0.10 | 0.26 |
| K | 0.20 | 0.60 |
| M | 0° | 10° |
| S | 2.50 | 3.00 |

SOLDERING FOOTPRINT*

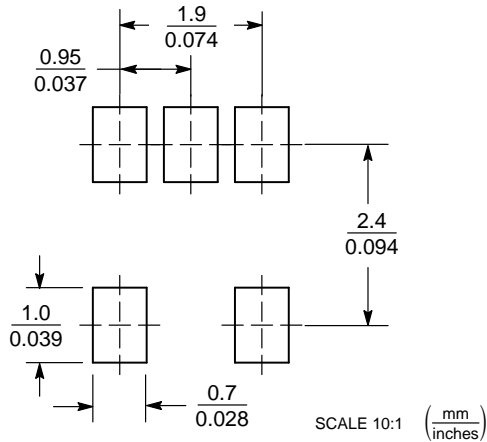

*For additional information on our Pb-Free strategy and soldering details, please download the ON Semiconductor Soldering and Mounting Techniques Reference Manual, SOLDERRM/D.

PACKAGE DIMENSIONS

Micro8™
CASE 846A-02
ISSUE J

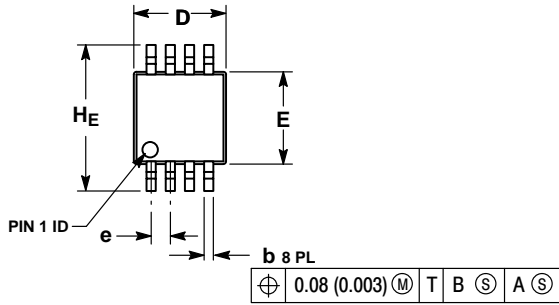

- NOTES:
1. DIMENSIONING AND TOLERANCING PER ANSI Y14.5M, 1982.
 2. CONTROLLING DIMENSION: MILLIMETER.
 3. DIMENSION A DOES NOT INCLUDE MOLD FLASH, PROTRUSIONS OR GATE BURRS. MOLD FLASH, PROTRUSIONS OR GATE BURRS SHALL NOT EXCEED 0.15 (0.006) PER SIDE.
 4. DIMENSION B DOES NOT INCLUDE INTERLEAD FLASH OR PROTRUSION. INTERLEAD FLASH OR PROTRUSION SHALL NOT EXCEED 0.25 (0.010) PER SIDE.
 5. 846A-01 OBSOLETE, NEW STANDARD 846A-02.

| DIM | MILLIMETERS | | | INCHES | | |
|-----|-------------|------|------|-----------|-------|-------|
| | MIN | NOM | MAX | MIN | NOM | MAX |
| A | --- | --- | 1.10 | --- | --- | 0.043 |
| A1 | 0.05 | 0.08 | 0.15 | 0.002 | 0.003 | 0.006 |
| b | 0.25 | 0.33 | 0.40 | 0.010 | 0.013 | 0.016 |
| c | 0.13 | 0.18 | 0.23 | 0.005 | 0.007 | 0.009 |
| D | 2.90 | 3.00 | 3.10 | 0.114 | 0.118 | 0.122 |
| E | 2.90 | 3.00 | 3.10 | 0.114 | 0.118 | 0.122 |
| e | 0.65 BSC | | | 0.026 BSC | | |
| L | 0.40 | 0.55 | 0.70 | 0.016 | 0.021 | 0.028 |
| HE | 4.75 | 4.90 | 5.05 | 0.187 | 0.193 | 0.199 |

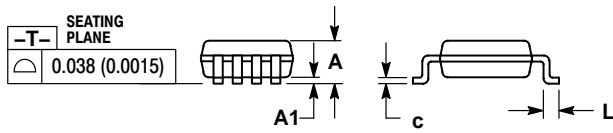

RECOMMENDED SOLDERING FOOTPRINT*

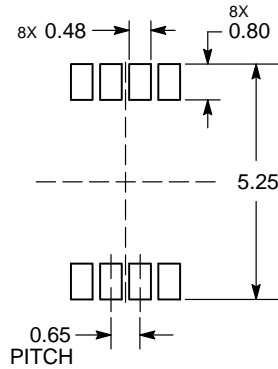

*For additional information on our Pb-Free strategy and soldering details, please download the ON Semiconductor Soldering and Mounting Techniques Reference Manual, SOLDERRM/D.

PACKAGE DIMENSIONS

SOIC-8 NB
CASE 751-07
ISSUE AK

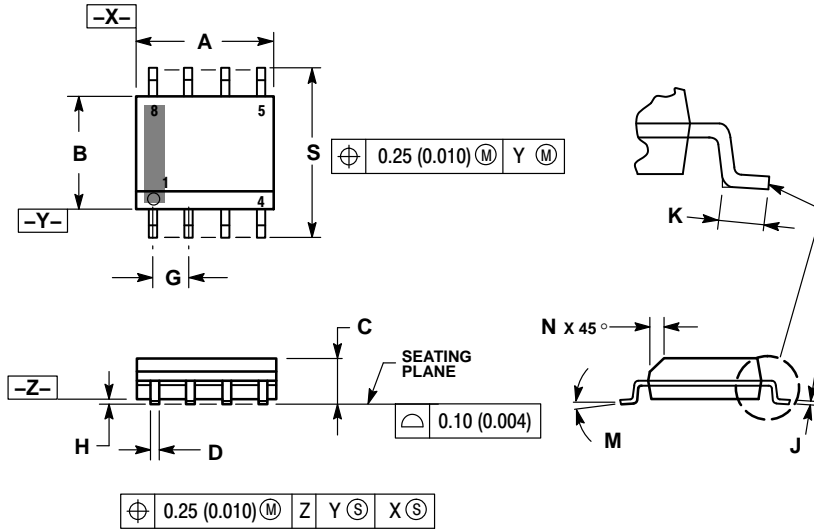

NOTES:

1. DIMENSIONING AND TOLERANCING PER ANSI Y14.5M, 1982.
2. CONTROLLING DIMENSION: MILLIMETER.
3. DIMENSION A AND B DO NOT INCLUDE MOLD PROTRUSION.
4. MAXIMUM MOLD PROTRUSION 0.15 (0.006) PER SIDE.
5. DIMENSION D DOES NOT INCLUDE DAMBAR PROTRUSION. ALLOWABLE DAMBAR PROTRUSION SHALL BE 0.127 (0.005) TOTAL IN EXCESS OF THE D DIMENSION AT MAXIMUM MATERIAL CONDITION.
6. 751-01 THRU 751-06 ARE OBSOLETE. NEW STANDARD IS 751-07.

| DIM | MILLIMETERS | | INCHES | |
|-----|-------------|------|-----------|-------|
| | MIN | MAX | MIN | MAX |
| A | 4.80 | 5.00 | 0.189 | 0.197 |
| B | 3.80 | 4.00 | 0.150 | 0.157 |
| C | 1.35 | 1.75 | 0.053 | 0.069 |
| D | 0.33 | 0.51 | 0.013 | 0.020 |
| G | 1.27 BSC | | 0.050 BSC | |
| H | 0.10 | 0.25 | 0.004 | 0.010 |
| J | 0.19 | 0.25 | 0.007 | 0.010 |
| K | 0.40 | 1.27 | 0.016 | 0.050 |
| M | 0° | 8° | 0° | 8° |
| N | 0.25 | 0.50 | 0.010 | 0.020 |
| S | 5.80 | 6.20 | 0.228 | 0.244 |

SOLDERING FOOTPRINT*

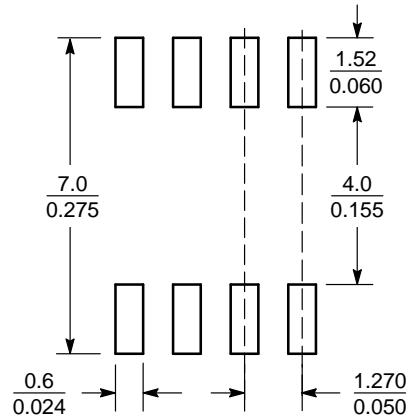

SCALE 6:1 $\left(\frac{\text{mm}}{\text{inches}}\right)$

*For additional information on our Pb-Free strategy and soldering details, please download the ON Semiconductor Soldering and Mounting Techniques Reference Manual, SOLDERRM/D.

PACKAGE DIMENSIONS

TSSOP-8
CASE 948S
ISSUE C

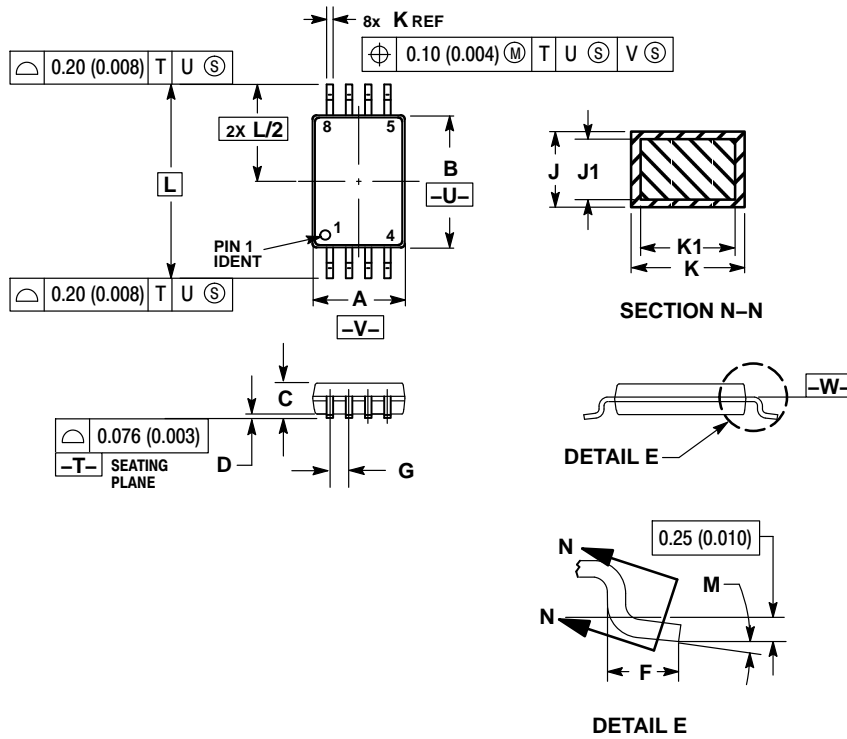

NOTES:

1. DIMENSIONING AND TOLERANCING PER ANSI Y14.5M, 1982.
2. CONTROLLING DIMENSION: MILLIMETER.
3. DIMENSION A DOES NOT INCLUDE MOLD FLASH, PROTRUSIONS OR GATE BURRS. MOLD FLASH OR GATE BURRS SHALL NOT EXCEED 0.15 (0.006) PER SIDE.
4. DIMENSION B DOES NOT INCLUDE INTERLEAD FLASH OR PROTRUSION. INTERLEAD FLASH OR PROTRUSION SHALL NOT EXCEED 0.25 (0.010) PER SIDE.
5. TERMINAL NUMBERS ARE SHOWN FOR REFERENCE ONLY.
6. DIMENSION A AND B ARE TO BE DETERMINED AT DATUM PLANE -W-.

| DIM | MILLIMETERS | | INCHES | |
|-----|-------------|------|-----------|-------|
| | MIN | MAX | MIN | MAX |
| A | 2.90 | 3.10 | 0.114 | 0.122 |
| B | 4.30 | 4.50 | 0.169 | 0.177 |
| C | --- | 1.10 | --- | 0.043 |
| D | 0.05 | 0.15 | 0.002 | 0.006 |
| F | 0.50 | 0.70 | 0.020 | 0.028 |
| G | 0.65 BSC | | 0.026 BSC | |
| J | 0.09 | 0.20 | 0.004 | 0.008 |
| J1 | 0.09 | 0.16 | 0.004 | 0.006 |
| K | 0.19 | 0.30 | 0.007 | 0.012 |
| K1 | 0.19 | 0.25 | 0.007 | 0.010 |
| L | 6.40 BSC | | 0.252 BSC | |
| M | 0° | 8° | 0° | 8° |

PACKAGE DIMENSIONS

TSSOP-14
CASE 948G
ISSUE B

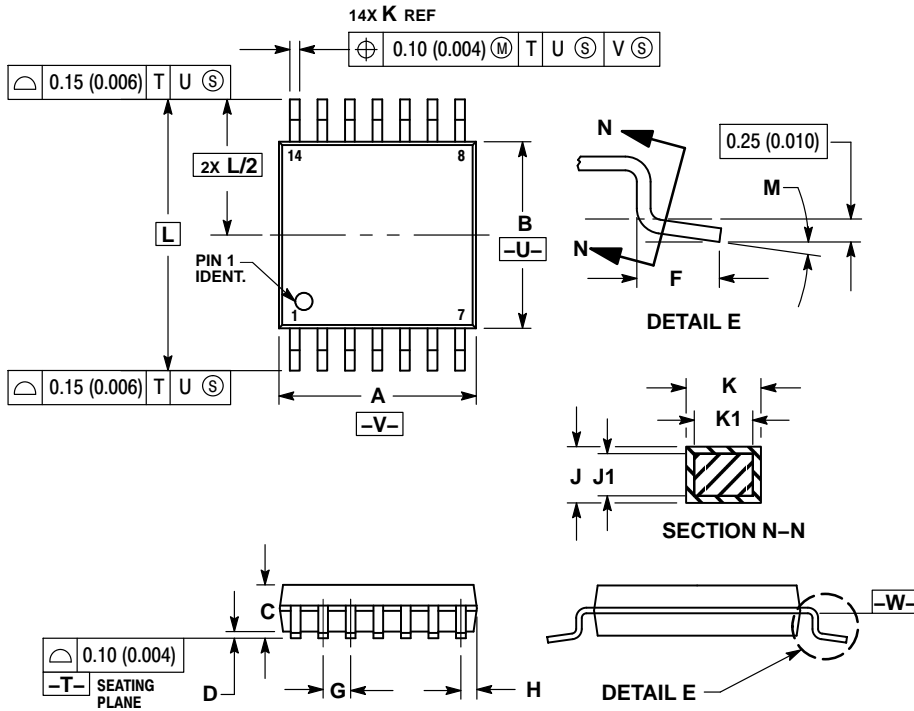

- NOTES:
1. DIMENSIONING AND TOLERANCING PER ANSI Y14.5M, 1982.
 2. CONTROLLING DIMENSION: MILLIMETER.
 3. DIMENSION A DOES NOT INCLUDE MOLD FLASH, PROTRUSIONS OR GATE BURRS. MOLD FLASH OR GATE BURRS SHALL NOT EXCEED 0.15 (0.006) PER SIDE.
 4. DIMENSION B DOES NOT INCLUDE INTERLEAD FLASH OR PROTRUSION. INTERLEAD FLASH OR PROTRUSION SHALL NOT EXCEED 0.25 (0.010) PER SIDE.
 5. DIMENSION K DOES NOT INCLUDE DAMBAR PROTRUSION. ALLOWABLE DAMBAR PROTRUSION SHALL BE 0.08 (0.003) TOTAL IN EXCESS OF THE K DIMENSION AT MAXIMUM MATERIAL CONDITION.
 6. TERMINAL NUMBERS ARE SHOWN FOR REFERENCE ONLY.
 7. DIMENSION A AND B ARE TO BE DETERMINED AT DATUM PLANE -W-.

| DIM | MILLIMETERS | | INCHES | |
|-----|-------------|------|-----------|-------|
| | MIN | MAX | MIN | MAX |
| A | 4.90 | 5.10 | 0.193 | 0.200 |
| B | 4.30 | 4.50 | 0.169 | 0.177 |
| C | — | 1.20 | — | 0.047 |
| D | 0.05 | 0.15 | 0.002 | 0.006 |
| F | 0.50 | 0.75 | 0.020 | 0.030 |
| G | 0.65 BSC | | 0.026 BSC | |
| H | 0.50 | 0.60 | 0.020 | 0.024 |
| J | 0.09 | 0.20 | 0.004 | 0.008 |
| J1 | 0.09 | 0.16 | 0.004 | 0.006 |
| K | 0.19 | 0.30 | 0.007 | 0.012 |
| K1 | 0.19 | 0.25 | 0.007 | 0.010 |
| L | 6.40 BSC | | 0.252 BSC | |
| M | 0° - 8° | | 0° - 8° | |

SOLDERING FOOTPRINT*

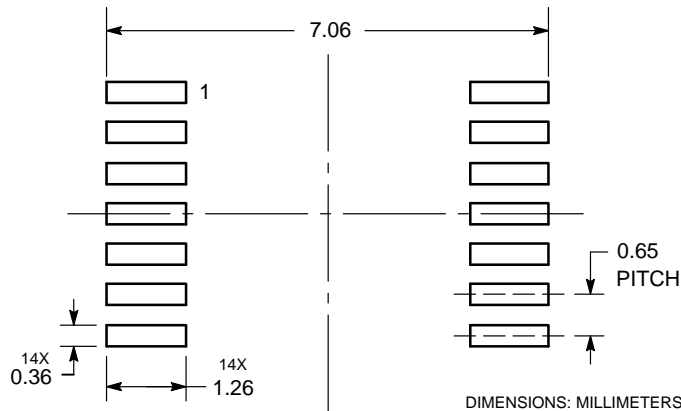

*For additional information on our Pb-Free strategy and soldering details, please download the ON Semiconductor Soldering and Mounting Techniques Reference Manual, SOLDERRM/D.

PACKAGE DIMENSIONS

SOIC-14 NB
CASE 751A-03
ISSUE K

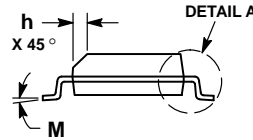
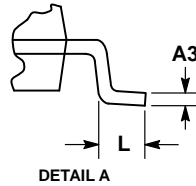
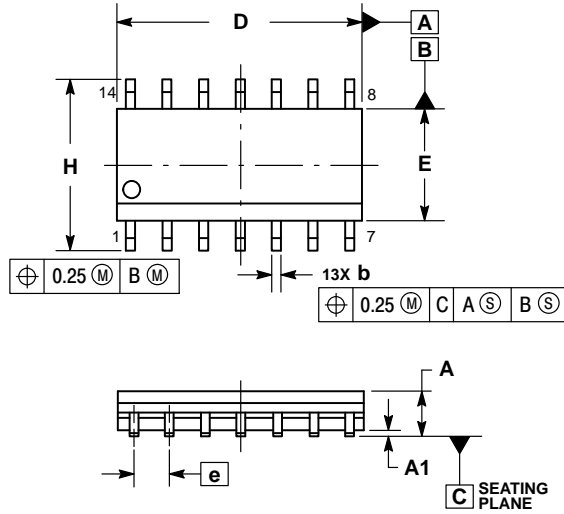

NOTES:

1. DIMENSIONING AND TOLERANCING PER ASME Y14.5M, 1994.
2. CONTROLLING DIMENSION: MILLIMETERS.
3. DIMENSION b DOES NOT INCLUDE DAMBAR PROTRUSION. ALLOWABLE PROTRUSION SHALL BE 0.13 TOTAL IN EXCESS OF AT MAXIMUM MATERIAL CONDITION.
4. DIMENSIONS D AND E DO NOT INCLUDE MOLD PROTRUSIONS.
5. MAXIMUM MOLD PROTRUSION 0.15 PER SIDE.

| DIM | MILLIMETERS | | INCHES | |
|-----|-------------|-----------|--------|-------|
| | MIN | MAX | MIN | MAX |
| A | 1.35 | 1.75 | 0.054 | 0.068 |
| A1 | 0.10 | 0.25 | 0.004 | 0.010 |
| A3 | 0.19 | 0.25 | 0.008 | 0.010 |
| b | 0.35 | 0.49 | 0.014 | 0.019 |
| D | 8.55 | 8.75 | 0.337 | 0.344 |
| E | 3.80 | 4.00 | 0.150 | 0.157 |
| e | 1.27 BSC | 0.050 BSC | | |
| H | 5.80 | 6.20 | 0.228 | 0.244 |
| h | 0.25 | 0.50 | 0.010 | 0.019 |
| L | 0.40 | 1.25 | 0.016 | 0.049 |
| M | 0° | 7° | 0° | 7° |

SOLDERING FOOTPRINT*

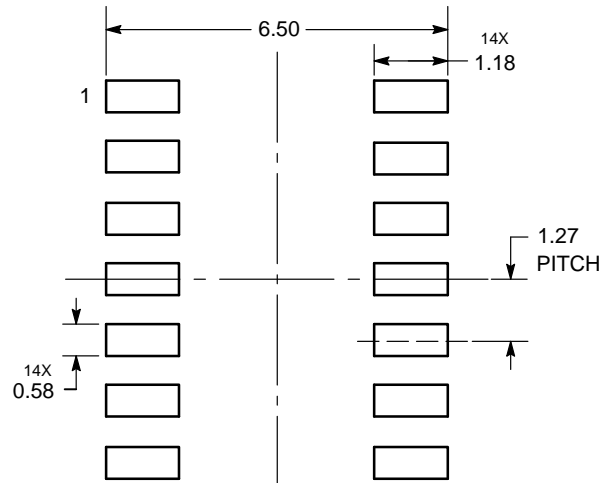

DIMENSIONS: MILLIMETERS

*For additional information on our Pb-Free strategy and soldering details, please download the ON Semiconductor Soldering and Mounting Techniques Reference Manual, SOLDERRM/D.

ON Semiconductor and the are registered trademarks of Semiconductor Components Industries, LLC (SCILLC) or its subsidiaries in the United States and/or other countries. SCILLC owns the rights to a number of patents, trademarks, copyrights, trade secrets, and other intellectual property. A listing of SCILLC's product/patent coverage may be accessed at www.onsemi.com/site/pdf/Patent-Marking.pdf. SCILLC reserves the right to make changes without further notice to any products herein. SCILLC makes no warranty, representation or guarantee regarding the suitability of its products for any particular purpose, nor does SCILLC assume any liability arising out of the application or use of any product or circuit, and specifically disclaims any and all liability, including without limitation special, consequential or incidental damages. "Typical" parameters which may be provided in SCILLC data sheets and/or specifications can and do vary in different applications and actual performance may vary over time. All operating parameters, including "Typicals" must be validated for each customer application by customer's technical experts. SCILLC does not convey any license under its patent rights nor the rights of others. SCILLC products are not designed, intended, or authorized for use as components in systems intended for surgical implant into the body, or other applications intended to support or sustain life, or for any other application in which the failure of the SCILLC product could create a situation where personal injury or death may occur. Should Buyer purchase or use SCILLC products for any such unintended or unauthorized application, Buyer shall indemnify and hold SCILLC and its officers, employees, subsidiaries, affiliates, and distributors harmless against all claims, costs, damages, and expenses, and reasonable attorney fees arising out of, directly or indirectly, any claim of personal injury or death associated with such unintended or unauthorized use, even if such claim alleges that SCILLC was negligent regarding the design or manufacture of the part. SCILLC is an Equal Opportunity/Affirmative Action Employer. This literature is subject to all applicable copyright laws and is not for resale in any manner.

PUBLICATION ORDERING INFORMATION

LITERATURE FULFILLMENT:
Literature Distribution Center for ON Semiconductor
P.O. Box 5163, Denver, Colorado 80217 USA
Phone: 303-675-2175 or 800-344-3860 Toll Free USA/Canada
Fax: 303-675-2176 or 800-344-3867 Toll Free USA/Canada
Email: orderlit@onsemi.com

N. American Technical Support: 800-282-9855 Toll Free USA/Canada
Europe, Middle East and Africa Technical Support:
Phone: 421 33 790 2910
Japan Customer Focus Center
Phone: 81-3-5817-1050

ON Semiconductor Website: www.onsemi.com
Order Literature: <http://www.onsemi.com/orderlit>

For additional information, please contact your local Sales Representative

Компания «Океан Электроники» предлагает заключение долгосрочных отношений при поставках импортных электронных компонентов на взаимовыгодных условиях!

Наши преимущества:

- Поставка оригинальных импортных электронных компонентов напрямую с производств Америки, Европы и Азии, а так же с крупнейших складов мира;
- Широкая линейка поставок активных и пассивных импортных электронных компонентов (более 30 млн. наименований);
- Поставка сложных, дефицитных, либо снятых с производства позиций;
- Оперативные сроки поставки под заказ (от 5 рабочих дней);
- Экспресс доставка в любую точку России;
- Помощь Конструкторского Отдела и консультации квалифицированных инженеров;
- Техническая поддержка проекта, помощь в подборе аналогов, поставка прототипов;
- Поставка электронных компонентов под контролем ВП;
- Система менеджмента качества сертифицирована по Международному стандарту ISO 9001;
- При необходимости вся продукция военного и аэрокосмического назначения проходит испытания и сертификацию в лаборатории (по согласованию с заказчиком);
- Поставка специализированных компонентов военного и аэрокосмического уровня качества (Xilinx, Altera, Analog Devices, Intersil, Interpoint, Microsemi, Actel, Aeroflex, Peregrine, VPT, Syfer, Eurofarad, Texas Instruments, MS Kennedy, Miteq, Cobham, E2V, MA-COM, Hittite, Mini-Circuits, General Dynamics и др.);

Компания «Океан Электроники» является официальным дистрибьютором и эксклюзивным представителем в России одного из крупнейших производителей разъемов военного и аэрокосмического назначения «JONHON», а так же официальным дистрибьютором и эксклюзивным представителем в России производителя высокотехнологичных и надежных решений для передачи СВЧ сигналов «FORSTAR».



JONHON

«JONHON» (основан в 1970 г.)

Разъемы специального, военного и аэрокосмического назначения:

(Применяются в военной, авиационной, аэрокосмической, морской, железнодорожной, горно- и нефтедобывающей отраслях промышленности)

«FORSTAR» (основан в 1998 г.)

ВЧ соединители, коаксиальные кабели, кабельные сборки и микроволновые компоненты:

(Применяются в телекоммуникациях гражданского и специального назначения, в средствах связи, РЛС, а так же военной, авиационной и аэрокосмической отраслях промышленности).



Телефон: 8 (812) 309-75-97 (многоканальный)

Факс: 8 (812) 320-03-32

Электронная почта: ocean@oceanchips.ru

Web: <http://oceanchips.ru/>

Адрес: 198099, г. Санкт-Петербург, ул. Калинина, д. 2, корп. 4, лит. А