

LTM4625 5A Small Footprint Step-Down µModule Regulator

DESCRIPTION

Demonstration circuit 2171A-B features the **LTM[®]4625** µModule[®] regulator, a tiny low profile high performance step-down regulator. The LTM4625 has an operating input voltage range of 4V to 20V and is able to provide an output current of up to 5A. The output voltage is programmable from 0.6V to 5V. The LTM4625 is a complete DC/DC point-of-load regulator in a 6.25mm × 6.25mm × 5.01mm BGA package requiring only a few input and output capacitors. Output voltage tracking is available through the TRACK/

SS pin for supply rail sequencing. CLKIN, CLKOUT and PHMODE pins are available for clock synchronization and interleaving. The LTM4625 data sheet must be read in conjunction with this demo manual prior to working on or modifying demo circuit 2171A-B.

Design files for this circuit board are available at <http://www.linear.com/demo/DC2171A-B>

LT, LTC, LTM, Linear Technology, the Linear logo and µModule are registered trademarks of Linear Technology Corporation. All other trademarks are the property of their respective owners.

PERFORMANCE SUMMARY Specifications are at T_A = 25°C

PARAMETER	CONDITIONS / NOTES	VALUE
Input Voltage Range		4V to 20V
Output Voltage V _{OUT}	Jumper Selectable	1.0VDC, 1.2VDC, 1.5VDC, 1.8VDC, 2.5VDC, 3.3VDC, 5VDC
Maximum Continuous Output Current	Derating Is Necessary for Certain Operating Conditions. See Data Sheet for Details	5ADC
Default Operating Frequency		1MHz
Efficiency	V _{IN} = 12V, V _{OUT} = 1.8V, I _{OUT} = 5A	83.4% See Figure 2

BOARD PHOTO

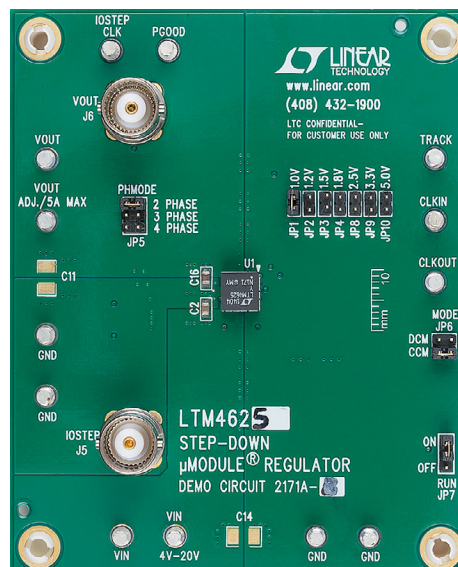

dc2171a-bf

QUICK START PROCEDURE

Demonstration circuit 2171A-B is an easy way to evaluate the performance of the LTM4625EY. Please refer to Figure 1 for test setup connections and follow the procedure below.

1. With power off, place the jumpers in the following positions for a typical 1.8V_{OUT} application:

JP7	JP6	JP4
RUN	MODE	VOUT SELECT
ON	CCM	1.8V

2. Before connecting input supply, load and meters, pre-set the input voltage supply to be between 4V to 20V. Pre-set the load current to 0A.
3. With power off, connect the load, input voltage supply and meters as shown in Figure 1.
4. Turn on input power supply. The output voltage meter should display the selected output voltage $\pm 1.5\%$.

5. Once the proper output voltage is established, adjust the load current within the 0A to 5A range and observe the load regulation, efficiency, and other parameters. Output voltage ripple should be measured at J6 with a BNC cable terminated into 50 Ω and an oscilloscope.
6. To observe increased light load efficiency place the MODE pin jumper (JP6) in the DCM position.
7. For optional load transient testing apply an adjustable positive pulse signal between IOSTEP CLK and GND pins. The pulse amplitude sets the load step current amplitude. The pulse width should be short (<1ms) and pulse duty cycle should be low (<15%) to limit the thermal stress on the load transient circuit. The load step current can be monitored with a BNC connected to J5 (50mV/A).

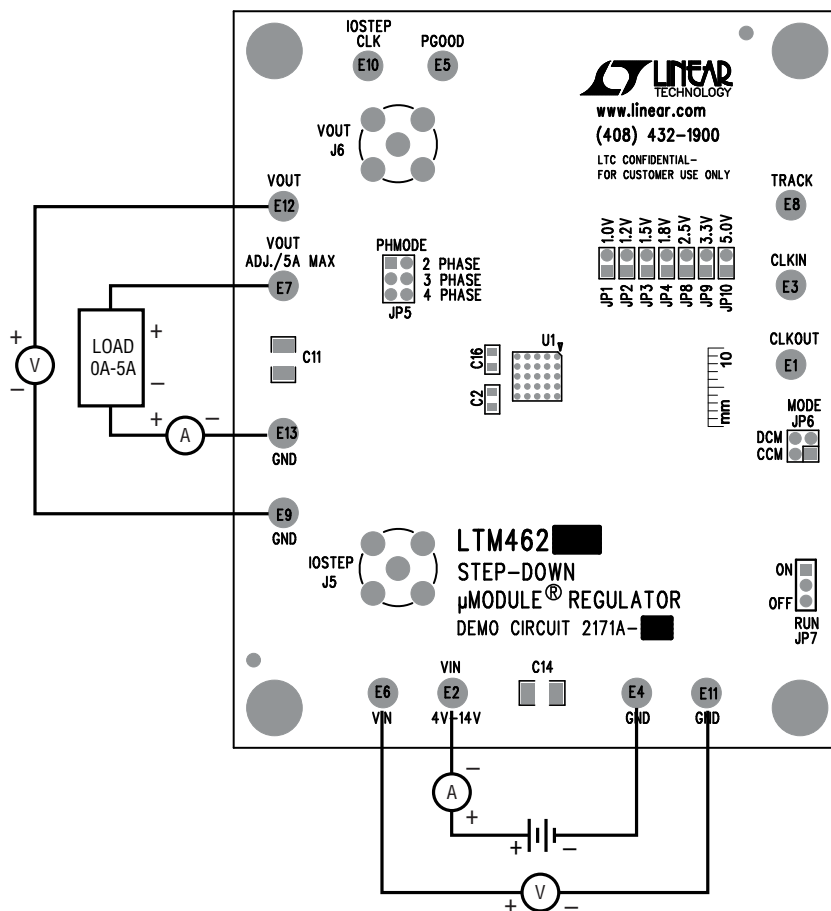

Figure 1. Test Setup

QUICK START PROCEDURE

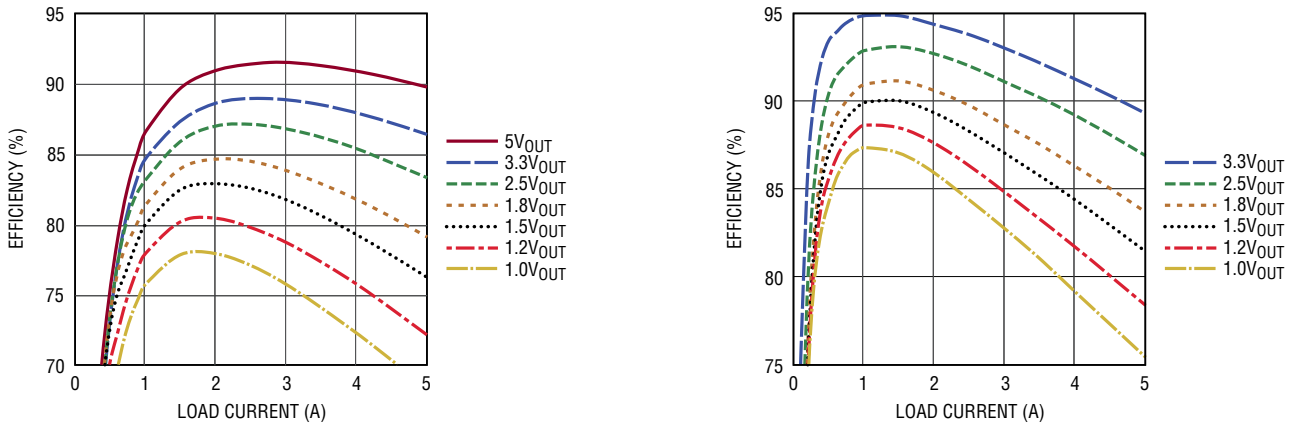
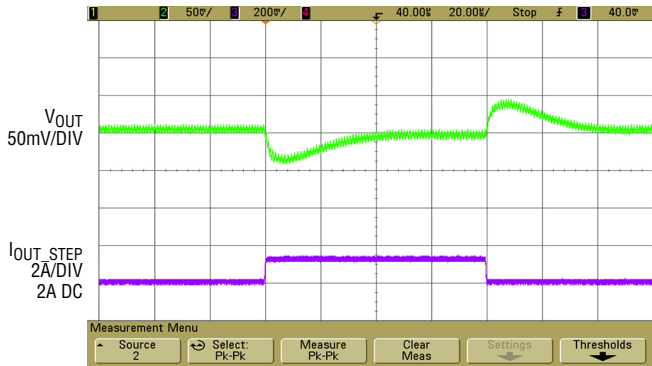
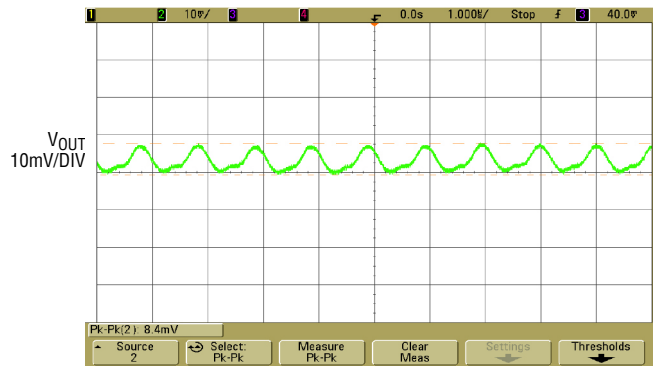

Figure 2. Measured Supply Efficiency at 12V_{IN} and 5V_{IN}



V _{IN} (V)	V _{OUT} (V)	C _{OUT}
12	1.8	1 × 100µF/6.3V + 1 × 22µF/6.3V + 1 × 47µF/6.3V

Figure 3. Measured Load Transient Response (2A-4A Load Step)



V _{IN} (V)	V _{OUT} (V)	I _{OUT} (A)	C _{OUT}
12	1.8	5	1 × 100µF/6.3V + 1 × 22µF/6.3V + 1 × 47µF/6.3V

Figure 4. Measured V_{OUT} Ripple

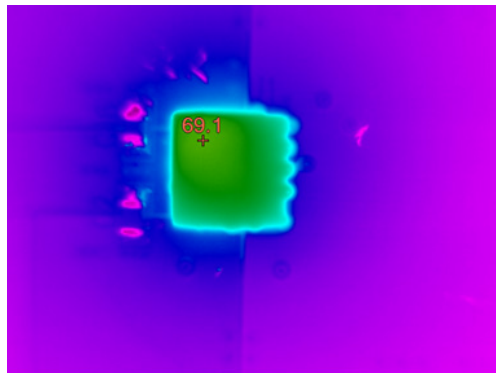

V _{IN} (V)	V _{OUT} (V)	I _{LOAD} (A)	f _{SW} (MHz)	T _{AMBIENT} (°C)	FORCED AIRFLOW (LFM)
12	1	5	1	25	0

Figure 5

DEMO MANUAL DC2171A-B

PARTS LIST

ITEM	QTY	REFERENCE	PART DESCRIPTION	MANUFACTURER/PART NUMBER
Required Circuit Components				
1	1	C1	CAP., X5R, 2.2 μ F, 10V, 10%, 0603	TAIYO YUDEN, LMK107BJ225KA-T
2	2	C3, C13	CAP., X5R, 22 μ F, 16V, 20%, 1206	TAIYO YUDEN, EMK316BJ226ML-T
3	1	C20	CAP., X5R, 47 μ F, 6.3V, 20%, 1206	TAIYO YUDEN, JMK316BJ476ML
4	1	C12	CAP., X5R, 100 μ F, 6.3V, 20%, 1206	TAIYO YUDEN, JMK316BJ107ML-T
5	2	C9, C15	CAP., X5R, 0.1 μ F, 25V, 10%, 0603	AVX, 06033D104KAT
6	1	R4	RES., CHIP, 90.9k, 1/16W, 1%, 0603	VISHAY, CRCW060390K9FKEA
7	1	R11	RES., CHIP, 10 Ω , 1/16W, 1%, 0603	VISHAY, CRCW060310R0FKEA
8	1	U1	I.C., LTM4625EY	LINEAR TECH., LTM4625EY#PBF
Additional Demo Board Circuit Components				
1	1	C10	CAP., X5R, 22 μ F, 25V, 10%, 7343	SANYO, 25TQC22MV
2	0	C11, C14	CAP., 1210, OPTION	OPTION
3	0	C5	CAP., 1206, OPTION	OPTION
4	3	C4, C6, C18	CAP., X5R, 1 μ F, 10V, 10%, 0603, OPTION	TAIYO YUDEN, LMK107BJ105KA-T
5	0	C7, C19	CAP., 0603, OPTION	OPTION
6	0	C17	CAP., 7343, OPTION	OPTION
7	1	C2	CAP., X5R, 10 μ F, 16V, 20%, 0805	TAIYO YUDEN, EMK212ABJ106KG-T
8	1	C16	CAP., X5R, 22 μ F, 6.3V, 20%, 0805	TAIYO YUDEN, JMK212ABJ226MD-T
9	1	C8	CAP., X7R, 100pF, 50V, 10%, 0603	AVX, 06033C101KAT2A
10	1	Q1	N-CHANNEL 30V MOSFET, TO-252	VISHAY, SUD50N03-09P-E3
11	1	RS2	RES., CHIP, 0.05 Ω , 1W, 1%, 2512	VISHAY, WSL2512R0500FEB
12	1	R3	RES., CHIP, 10k, 1/16W, 1%, 0603	VISHAY, CRCW060310K0FKEA
13	7	R5, R6, R7, R14, R15, R16	RES., CHIP, OPTION, 1/16W, 1%, 0603	OPTION
14	0	R1, R12, R2	RES., CHIP, OPTION, 1/16W, 1%, 0603	OPTION
15	1	R8, R10	RES., CHIP, 100k, 1/16W, 1%, 0603	VISHAY, CRCW0603100KFKEA
16	1	R9	RES., CHIP, 150k, 1/16W, 1%, 0603	VISHAY, CRCW0603150KFKEA
17	1	R13	RES., CHIP, 0 Ω , 1/16W, 1%, 0603	VISHAY, CRCW06030000Z0EA
Hardware				
1	11	E1-E13	TESTPOINT, TURRET, .095"	MILL-MAX, 2501-2-00-80-00-00-07-0
2	7	JP1-JP4, JP8-JP10	2mm SINGLE ROW HEADER, 2-PIN	SAMTEC, TMM102-02-L-S
3	1	JP6	2mm DOUBLE ROW HEADER, 2 x 2 PIN	SAMTEC, TMM-102-02-L-D
4	1	JP7	2mm SINGLE ROW HEADER, 3-PIN	SAMTEC, TMM-103-02-L-S
5	2	J5, J6	CONN, BNC, 5 PINS	CONNEX, 112404
6	3	JP1, JP6, JP7	SHUNT	SAMTEC, 2SN-BK-G
7	4	STAND OFF	STAND OFF, SNAP ON	KEYSTONE _8832

SCHEMATIC DIAGRAM

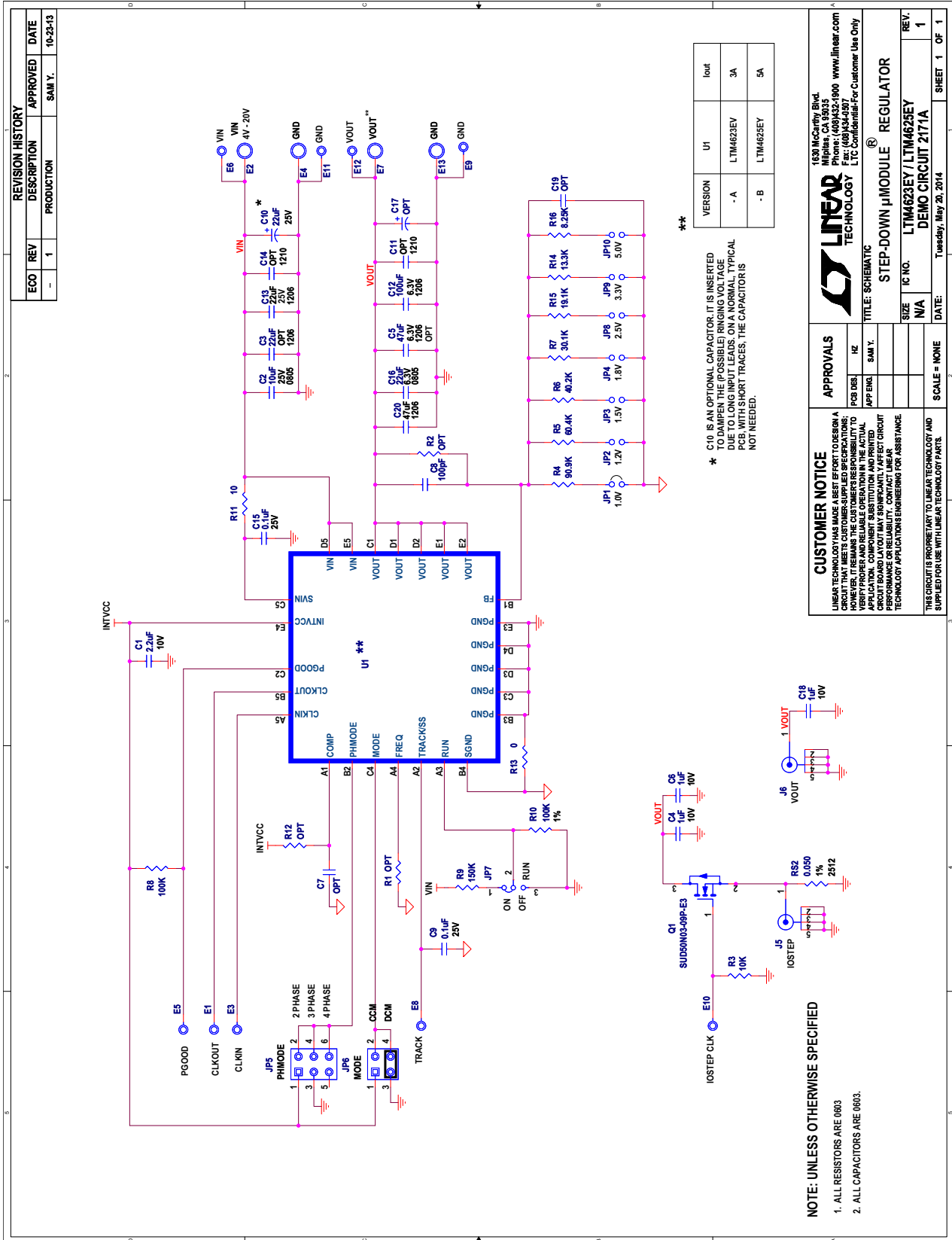

Information furnished by Linear Technology Corporation is believed to be accurate and reliable. However, no responsibility is assumed for its use. Linear Technology Corporation makes no representation that the interconnection of its circuits as described herein will not infringe on existing patent rights.

DEMO MANUAL DC2171A-B

DEMONSTRATION BOARD IMPORTANT NOTICE

Linear Technology Corporation (LTC) provides the enclosed product(s) under the following **AS IS** conditions:

This demonstration board (DEMO BOARD) kit being sold or provided by Linear Technology is intended for use for **ENGINEERING DEVELOPMENT OR EVALUATION PURPOSES ONLY** and is not provided by LTC for commercial use. As such, the DEMO BOARD herein may not be complete in terms of required design-, marketing-, and/or manufacturing-related protective considerations, including but not limited to product safety measures typically found in finished commercial goods. As a prototype, this product does not fall within the scope of the European Union directive on electromagnetic compatibility and therefore may or may not meet the technical requirements of the directive, or other regulations.

If this evaluation kit does not meet the specifications recited in the DEMO BOARD manual the kit may be returned within 30 days from the date of delivery for a full refund. **THE FOREGOING WARRANTY IS THE EXCLUSIVE WARRANTY MADE BY THE SELLER TO BUYER AND IS IN LIEU OF ALL OTHER WARRANTIES, EXPRESSED, IMPLIED, OR STATUTORY, INCLUDING ANY WARRANTY OF MERCHANTABILITY OR FITNESS FOR ANY PARTICULAR PURPOSE. EXCEPT TO THE EXTENT OF THIS INDEMNITY, NEITHER PARTY SHALL BE LIABLE TO THE OTHER FOR ANY INDIRECT, SPECIAL, INCIDENTAL, OR CONSEQUENTIAL DAMAGES.**

The user assumes all responsibility and liability for proper and safe handling of the goods. Further, the user releases LTC from all claims arising from the handling or use of the goods. Due to the open construction of the product, it is the user's responsibility to take any and all appropriate precautions with regard to electrostatic discharge. Also be aware that the products herein may not be regulatory compliant or agency certified (FCC, UL, CE, etc.).

No License is granted under any patent right or other intellectual property whatsoever. **LTC assumes no liability for applications assistance, customer product design, software performance, or infringement of patents or any other intellectual property rights of any kind.**

LTC currently services a variety of customers for products around the world, and therefore this transaction **is not exclusive**.

Please read the DEMO BOARD manual prior to handling the product. Persons handling this product must have electronics training and observe good laboratory practice standards. **Common sense is encouraged.**

This notice contains important safety information about temperatures and voltages. For further safety concerns, please contact a LTC application engineer.

Mailing Address:

Linear Technology
1630 McCarthy Blvd.
Milpitas, CA 95035

Copyright © 2004, Linear Technology Corporation

Компания «Океан Электроники» предлагает заключение долгосрочных отношений при поставках импортных электронных компонентов на взаимовыгодных условиях!

Наши преимущества:

- Поставка оригинальных импортных электронных компонентов напрямую с производств Америки, Европы и Азии, а так же с крупнейших складов мира;
- Широкая линейка поставок активных и пассивных импортных электронных компонентов (более 30 млн. наименований);
- Поставка сложных, дефицитных, либо снятых с производства позиций;
- Оперативные сроки поставки под заказ (от 5 рабочих дней);
- Экспресс доставка в любую точку России;
- Помощь Конструкторского Отдела и консультации квалифицированных инженеров;
- Техническая поддержка проекта, помощь в подборе аналогов, поставка прототипов;
- Поставка электронных компонентов под контролем ВП;
- Система менеджмента качества сертифицирована по Международному стандарту ISO 9001;
- При необходимости вся продукция военного и аэрокосмического назначения проходит испытания и сертификацию в лаборатории (по согласованию с заказчиком);
- Поставка специализированных компонентов военного и аэрокосмического уровня качества (Xilinx, Altera, Analog Devices, Intersil, Interpoint, Microsemi, Actel, Aeroflex, Peregrine, VPT, Syfer, Eurofarad, Texas Instruments, MS Kennedy, Miteq, Cobham, E2V, MA-COM, Hittite, Mini-Circuits, General Dynamics и др.);

Компания «Океан Электроники» является официальным дистрибьютором и эксклюзивным представителем в России одного из крупнейших производителей разъемов военного и аэрокосмического назначения «JONHON», а так же официальным дистрибьютором и эксклюзивным представителем в России производителя высокотехнологичных и надежных решений для передачи СВЧ сигналов «FORSTAR».



JONHON

«JONHON» (основан в 1970 г.)

Разъемы специального, военного и аэрокосмического назначения:

(Применяются в военной, авиационной, аэрокосмической, морской, железнодорожной, горно- и нефтедобывающей отраслях промышленности)

«FORSTAR» (основан в 1998 г.)

ВЧ соединители, коаксиальные кабели,
кабельные сборки и микроволновые компоненты:

(Применяются в телекоммуникациях гражданского и специального назначения, в средствах связи, РЛС, а так же военной, авиационной и аэрокосмической отраслях промышленности).



Телефон: 8 (812) 309-75-97 (многоканальный)

Факс: 8 (812) 320-03-32

Электронная почта: ocean@oceanchips.ru

Web: <http://oceanchips.ru/>

Адрес: 198099, г. Санкт-Петербург, ул. Калинина, д. 2, корп. 4, лит. А