

# NON-ENVIRONMENTAL EMI / RFI BACKSHELL



360-degree screen termination facility is offered in this Backshell in addition to other features of the Non-Environmental type. Available in straight, 90 degree bent and 45 degree bent varieties, it accommodates both individual and overall shielding.

For Connector Group		Page No.
J	→	III-1 - III-7
K	→	III-8 - III-12
L	→	III-13 - III-17
M	→	III-18 - III-23
N	→	III-24 - III-29

**Note:** For Connector group Identification refer Table 1 - A, B, C, D (Page 7-11) and for Material / Plating Finish, Refer Table-2 (Page 12)



### Connector Group - J

### Straight

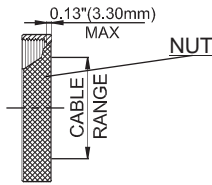

#### Amphenol Part Number



#### MIL Part Number



**NOTE:** \* For more cable entry and length options, contact factory

TABLE - A																						
AMPHENOL PART NUMBER DESIGNATOR			MIL PART NUMBER DESIGNATOR	CONNECTOR SHELL SIZE	A DIA. (MAX)		B (MAX)		C (REF)		G (MAX)		CABLE RANGE									
SHELL SIZE	ENTRY SIZE	LENGTH	DASH NO		INCH	MM	INCH	MM	INCH	MM	INCH	MM	MIN				MAX					
													INCH	MM	INCH	MM	INCH	MM	INCH	MM		
08	01	1	5	8	0.62	15.67	2.13	54.10	1.03	26.09	0.96	24.31	0.13	3.18	0.25	6.35	0.13	3.18	0.25	6.35		
		2	6		0.62	15.67	3.13	79.50	1.03	26.09	0.96	24.31	0.13	3.18	0.25	6.35	0.13	3.18	0.25	6.35		
	02	1	7*		0.62	15.67	2.88	73.15	1.03	26.09	1.15	29.08	0.25	6.35	0.44	11.10	0.25	6.35	0.44	11.10		
		2	8*		0.62	15.67	3.88	98.55	1.03	26.09	1.15	29.08	0.25	6.35	0.44	11.10	0.25	6.35	0.44	11.10		
10	01	1	9	10	0.73	18.64	2.13	54.10	1.03	26.09	0.96	24.31	0.13	3.18	0.31	7.92	0.13	3.18	0.31	7.92		
		2	10		0.73	18.64	3.13	79.50	1.03	26.09	0.96	24.31	0.13	3.18	0.31	7.92	0.13	3.18	0.31	7.92		
	02	1	11*		0.73	18.64	2.88	73.15	1.03	26.09	1.15	29.08	0.25	6.35	0.44	11.10	0.25	6.35	0.44	11.10		
		2	12*		0.73	18.64	3.88	98.55	1.03	26.09	1.15	29.08	0.25	6.35	0.44	11.10	0.25	6.35	0.44	11.10		
	03	1	136		0.73	18.64	2.13	54.10	1.03	26.09	1.15	29.08	0.25	6.35	0.38	9.53	0.25	6.35	0.38	9.53		
		2	137		0.73	18.64	3.13	79.50	1.03	26.09	1.15	29.08	0.25	6.35	0.38	9.53	0.25	6.35	0.38	9.53		
	12	01	1		13	7/12	0.86	21.79	2.13	54.10	1.03	26.09	1.15	29.08	0.25	6.35	0.44	11.10	0.25	6.35	0.44	11.10
			2		14		0.86	21.79	3.13	79.50	1.03	26.09	1.15	29.08	0.25	6.35	0.44	11.10	0.25	6.35	0.44	11.10
02		1	15*	0.86	21.79		2.88	73.15	1.03	26.09	1.33	33.83	0.35	8.89	0.63	15.88	0.35	8.89	0.63	15.88		
		2	16*	0.86	21.79		3.88	98.55	1.03	26.09	1.33	33.83	0.35	8.89	0.63	15.88	0.35	8.89	0.63	15.88		
03		1	111	0.86	21.79		2.13	54.10	1.03	26.09	1.33	33.83	0.35	8.89	0.50	12.70	0.35	8.89	0.50	12.70		
		2	112	0.86	21.79		3.13	79.50	1.03	26.09	1.33	33.83	0.35	8.89	0.50	12.70	0.35	8.89	0.50	12.70		
04		1	114	0.86	21.79		2.13	54.10	1.03	26.09	0.96	24.31	0.13	3.18	0.31	7.92	0.13	3.18	0.31	7.92		
		2	115	0.86	21.79		3.13	79.50	1.03	26.09	0.96	24.31	0.13	3.18	0.31	7.92	0.13	3.18	0.31	7.92		
05	1	138	0.86	21.79	2.13	54.10	1.03	26.09	1.33	33.83	0.35	8.89	0.50	12.70	0.35	8.89	0.50	12.70				
	2	139	0.86	21.79	3.13	79.50	1.03	26.09	1.33	33.83	0.35	8.89	0.50	12.70	0.35	8.89	0.50	12.70				
14	01	1	17	12/14	0.98	24.99	2.13	54.10	1.03	26.09	1.33	33.83	0.35	8.89	0.58	14.61	0.35	8.89	0.58	14.61		
		2	18		0.98	24.99	3.13	79.50	1.03	26.09	1.33	33.83	0.35	8.89	0.58	14.61	0.35	8.89	0.58	14.61		
	02	1	19*		0.98	24.99	2.88	73.15	1.06	26.90	1.55	39.40	0.50	12.70	0.75	19.05	0.50	12.70	0.75	19.05		
		2	20*		0.98	24.99	3.88	98.55	1.06	26.90	1.55	39.40	0.50	12.70	0.75	19.05	0.50	12.70	0.75	19.05		
	03	1	116		0.98	24.99	2.13	54.10	1.03	26.09	1.15	29.08	0.25	6.35	0.44	11.10	0.25	6.35	0.44	11.10		
		2	117		0.98	24.99	3.13	79.50	1.03	26.09	1.15	29.08	0.25	6.35	0.44	11.10	0.25	6.35	0.44	11.10		
	04	1	150		0.98	24.99	2.13	54.10	1.03	26.09	0.96	24.31	0.13	3.18	0.31	7.92	0.13	3.18	0.31	7.92		
		2	151		0.98	24.99	3.13	79.50	1.03	26.09	0.96	24.31	0.13	3.18	0.31	7.92	0.13	3.18	0.31	7.92		

Table Continued





### Connector Group - J

90°, 45°

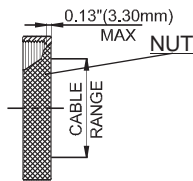
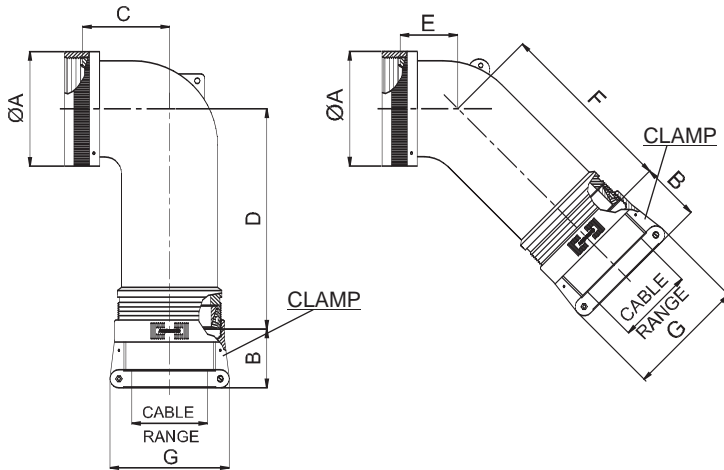

#### Amphenol Part Number

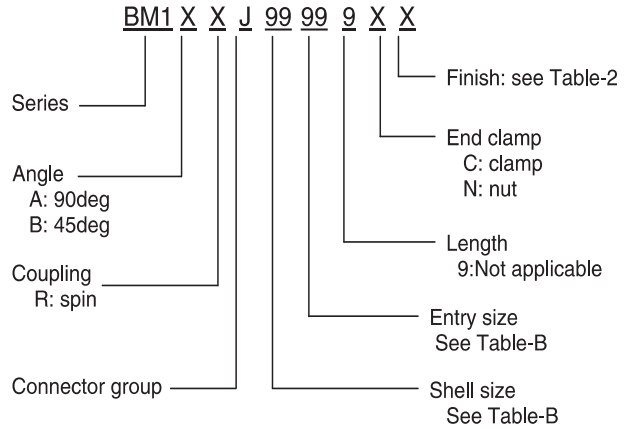

#### MIL Part Number

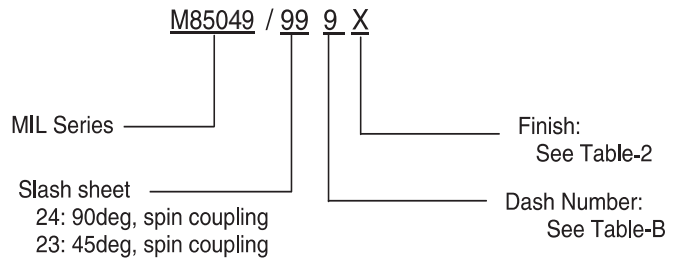

NOTE: \* For more cable entry options, contact factory

TABLE - B													
AMPHENOL PART NUMBER DESIGNATOR		MIL PART NUMBER DESIGNATOR	CONNECTOR SHELL SIZE	A DIA. (MAX)		B (REF)		C (MAX)		D (MAX)		E (MAX)	
SHELL SIZE	ENTRY SIZE	DASH NO		INCH	MM	INCH	MM	INCH	MM	INCH	MM	INCH	MM
08	01	3	8	0.62	15.67	1.03	26.09	0.67	17.02	1.26	32.00	0.63	16.00
10	01	4		10	0.73	18.64	1.03	26.09	0.76	19.30	1.98	50.29	0.69
	02	49*	0.73		18.64	1.03	26.09	1.52	38.61	2.00	50.80	1.50	38.10
03	5	0.73	18.64		1.03	26.09	0.76	19.30	1.38	35.05	0.69	17.53	
12	01	6	7/12	0.86	21.79	1.03	26.09	0.77	19.56	2.00	50.80	0.75	19.05
	02	71*		0.86	21.79	1.03	26.09	1.81	45.97	2.16	54.86	1.65	41.91
	03	7		0.86	21.79	1.03	26.09	0.77	19.56	2.00	50.80	0.75	19.05
	04	8		0.86	21.79	1.03	26.09	0.77	19.56	1.40	35.56	0.75	19.05
14	01	9	12/14	0.98	24.99	1.03	26.09	0.87	22.10	2.07	52.58	0.81	20.57
	02	10		0.98	24.99	1.03	26.09	0.87	22.10	1.72	43.69	0.81	20.57
	03	50*		0.98	24.99	1.06	26.90	1.89	48.01	2.33	59.18	1.84	46.74
	04	74		0.98	24.99	1.03	26.09	0.87	22.10	2.07	52.58	0.81	20.57
16	01	11	19/16	1.11	28.24	1.03	26.09	1.05	26.67	2.16	54.86	0.91	23.11
	02	12		1.11	28.24	1.06	26.90	1.05	26.67	1.81	45.97	0.91	23.11
	03	40		1.11	28.24	1.03	26.09	1.05	26.67	2.16	54.86	0.91	23.11
	04	51*		1.11	28.24	1.16	29.36	2.04	51.82	2.44	61.98	1.94	49.28
	05	75		1.11	28.24	1.03	26.09	1.05	26.67	2.16	54.86	0.91	23.11

Table Continued



Connector Group - J

90°, 45°

TABLE - B													
AMPHENOL PART NUMBER DESIGNATOR		MIL PART NUMBER DESIGNATOR	CONNECTOR SHELL SIZE	A DIA. (MAX)		B (REF)		C (MAX)		D (MAX)		E (MAX)	
SHELL SIZE	ENTRY SIZE	DASH NO		INCH	MM	INCH	MM	INCH	MM	INCH	MM	INCH	MM
18	01	13	27/18	1.22	30.94	1.03	26.09	1.14	28.96	2.33	59.18	1.09	27.69
	02	14		1.22	30.94	1.16	29.36	1.14	28.96	1.98	50.29	1.09	27.69
	03	41		1.22	30.94	1.03	26.09	1.14	28.96	2.33	59.18	1.09	27.69
	04	42		1.22	30.94	1.03	26.09	1.14	28.96	2.33	59.18	1.09	27.69
	05	52		1.22	30.94	1.06	26.90	1.14	28.96	2.33	59.18	1.09	27.69
	06	72*		1.22	30.94	1.16	29.36	2.05	52.07	2.44	61.98	1.94	49.28
20	01	15	37/20	1.35	34.16	1.03	26.09	1.14	28.96	2.33	59.18	1.09	27.69
	02	16		1.35	34.16	1.16	29.36	1.14	28.96	1.98	50.29	1.09	27.69
	03	43		1.35	34.16	1.03	26.09	1.14	28.96	2.33	59.18	1.09	27.69
	04	54		1.35	34.16	1.06	26.90	1.14	28.96	2.33	59.18	1.09	27.69
	05	55		1.35	34.16	1.38	34.93	2.14	54.36	2.61	66.29	2.06	52.32
22	01	17	22	1.47	37.29	1.06	26.90	1.29	32.77	2.44	61.98	1.19	30.23
	02	18		1.47	37.29	1.38	34.93	1.29	32.77	2.09	53.09	1.19	30.23
	03	44		1.47	37.29	1.03	26.09	1.29	32.77	2.44	61.98	1.19	30.23
	04	45		1.47	37.29	1.03	26.09	1.29	32.77	2.44	61.98	1.19	30.23
	05	56		1.47	37.29	1.03	26.09	1.29	32.77	2.44	61.98	1.19	30.23
	06	57		1.47	37.29	1.16	29.36	1.29	32.77	2.44	61.98	1.19	30.23
	07	58*		1.47	37.29	1.38	34.93	2.14	54.36	2.61	66.29	2.06	52.32
24	01	19	24	1.59	40.46	1.06	26.90	1.29	32.77	2.44	61.98	1.19	30.23
	02	20		1.59	40.46	1.38	34.93	1.29	32.77	2.09	53.09	1.19	30.23
	03	46		1.59	40.46	1.03	26.09	1.29	32.77	2.44	61.98	1.19	30.23
	04	59		1.59	40.46	1.16	29.36	1.29	32.77	2.44	61.98	1.19	30.23
	05	73*		1.59	40.46	1.38	34.93	2.15	54.61	2.61	66.29	2.06	52.32
28	01	21	28	1.97	50.01	1.16	29.36	1.39	35.31	2.61	66.29	1.31	33.27
	02	22		1.97	50.01	1.50	38.10	1.39	35.31	2.26	57.40	1.31	33.27
	03	60		1.97	50.01	1.06	26.90	1.39	35.31	2.61	66.29	1.31	33.27
	04	61		1.97	50.01	1.38	34.93	1.39	35.31	2.61	66.29	1.31	33.27
32	01	23	32	2.22	56.36	1.16	29.36	1.74	44.20	2.86	72.64	1.38	35.05
	02	24		2.22	56.36	1.38	34.93	1.74	44.20	2.86	72.64	1.38	35.05
	03	25		2.22	56.36	1.78	45.24	1.74	44.20	2.51	63.75	1.38	35.05
	04	62		2.22	56.36	1.50	38.10	1.74	44.20	2.86	72.64	1.38	35.05
36	01	26	36	2.47	62.71	1.16	29.36	1.94	49.28	2.83	71.88	1.41	35.81
	02	27		2.47	62.71	1.50	38.10	1.94	49.28	2.83	71.88	1.41	35.81
	03	28		2.47	62.71	1.83	46.48	1.94	49.28	2.48	62.99	1.41	35.81
	04	47		2.47	62.71	1.06	26.90	1.94	49.28	2.83	71.88	1.41	35.81
	05	63		2.47	62.71	1.38	34.93	1.94	49.28	2.83	71.88	1.41	35.81
	06	64		2.47	62.71	1.78	45.24	1.94	49.28	2.83	71.88	1.41	35.81
40	01	29	40	2.72	69.06	1.16	29.36	2.69	68.33	2.83	71.88	2.16	54.86
	02	30		2.72	69.06	1.50	38.10	2.69	68.33	2.83	71.88	2.16	54.86
	03	31		2.72	69.06	1.83	46.48	2.69	68.33	2.48	62.99	2.16	54.86
	04	48		2.72	69.06	1.06	26.90	1.94	49.28	2.83	71.88	2.16	54.86
	05	65		2.72	69.06	1.38	34.93	2.69	68.33	2.83	71.88	2.16	54.86
	06	66		2.72	69.06	1.78	45.24	2.69	68.33	2.83	71.88	2.16	54.86
44	01	32	44	2.97	75.41	1.16	29.36	2.69	68.33	2.83	71.88	2.16	54.86
	02	33		2.97	75.41	1.50	38.10	2.69	68.33	2.83	71.88	2.16	54.86
	03	34		2.97	75.41	1.83	46.48	2.69	68.33	2.48	62.99	2.16	54.86
	04	67		2.97	75.41	1.38	34.93	2.69	68.33	2.83	71.88	2.16	54.86
	05	68		2.97	75.41	1.78	45.24	2.69	68.33	2.83	71.88	2.16	54.86
48	01	35	48	3.22	81.76	1.16	29.36	2.69	68.33	2.83	71.88	2.16	54.86
	02	36		3.22	81.76	1.50	38.10	2.69	68.33	2.83	71.88	2.16	54.86
	03	37		3.22	81.76	1.83	46.48	2.69	68.33	2.48	62.99	2.16	54.86
	04	69		3.22	81.76	1.38	34.93	2.69	68.33	2.83	71.88	2.16	54.86
	05	70		3.22	81.76	1.78	45.24	2.69	68.33	2.83	71.88	2.16	54.86

Table Continued

### Connector Group - J

90°, 45°

TABLE - B											
AMPHENOL PART NUMBER DESIGNATOR		MIL PART NUMBER DESIGNATOR	CONNECTOR SHELL SIZE	F (MAX)		G (MAX)		CABLE RANGE			
SHELL SIZE	ENTRY SIZE	DASH NO		INCH	MM	INCH	MM	MIN		MAX	
								INCH	MM	INCH	MM
08	01	3	8	1.25	31.75	0.96	24.31	0.13	3.18	0.25	6.35
10	01	4	10	1.92	48.77	0.96	24.31	0.13	3.18	0.31	7.92
	02	49*		1.98	50.29	1.15	29.08	0.25	6.35	0.44	11.10
	03	5		1.31	33.27	1.15	29.08	0.25	6.35	0.38	9.53
12	01	6	7/12	1.98	50.29	0.96	24.31	0.13	3.18	0.31	7.92
	02	71*		2.18	55.37	1.33	33.83	0.35	8.89	0.63	15.88
	03	7		1.98	50.29	1.15	29.08	0.25	6.35	0.44	11.10
	04	8		1.98	50.29	1.33	33.83	0.35	8.89	0.50	12.70
14	01	9	12/14	2.07	52.58	1.15	29.08	0.25	6.35	0.44	11.10
	02	10		1.72	43.69	1.33	33.83	0.35	8.89	0.58	14.61
	03	50*		2.37	60.20	1.55	39.40	0.50	12.70	0.75	19.05
	04	74		2.07	52.58	0.96	24.31	0.13	3.18	0.31	7.92
16	01	11	19/16	2.18	55.37	1.15	29.08	0.25	6.35	0.44	11.10
	02	12		1.82	46.23	1.55	39.40	0.50	12.70	0.70	17.78
	03	40		2.18	55.37	1.33	33.83	0.35	8.89	0.63	15.88
	04	51*		2.52	64.01	1.77	44.96	0.63	15.88	0.94	23.80
	05	75		2.18	55.37	0.96	24.31	0.13	3.18	0.31	7.92
18	01	13	27/18	2.37	60.20	1.33	33.83	0.35	8.89	0.63	15.88
	02	14		2.00	50.80	1.77	44.96	0.63	15.88	0.78	19.79
	03	41		2.37	60.20	0.96	24.31	0.13	3.18	0.31	7.92
	04	42		2.37	60.20	1.15	29.08	0.25	6.35	0.44	11.10
	05	52		2.37	60.20	1.55	39.40	0.50	12.70	0.75	19.05
	06	72*		2.52	64.01	1.77	44.96	0.63	15.88	0.94	23.80
20	01	15	37/20	2.37	60.20	1.33	33.83	0.35	8.89	0.63	15.88
	02	16		2.00	50.80	1.77	44.96	0.63	15.88	0.90	22.96
	03	43		2.37	60.20	1.15	29.08	0.25	6.35	0.44	11.10
	04	54		2.37	60.20	1.55	39.40	0.50	12.70	0.75	19.05
	05	55		2.57	65.28	2.11	53.67	0.88	22.23	1.25	31.75
22	01	17	22	2.52	64.01	1.55	39.40	0.50	12.70	0.75	19.05
	02	18		2.16	54.86	2.11	53.67	0.88	22.23	1.03	26.14
	03	44		2.52	64.01	0.96	24.31	0.13	3.18	0.31	7.92
	04	45		2.52	64.01	1.15	29.08	0.25	6.35	0.44	11.10
	05	56		2.52	64.01	1.33	33.83	0.35	8.89	0.63	15.88
	06	57		2.52	64.01	1.77	44.96	0.63	15.88	0.94	23.80
	07	58*		2.57	65.28	2.11	53.67	0.88	22.23	1.25	31.75
24	01	19	24	2.52	64.01	1.55	39.40	0.50	12.70	0.75	19.05
	02	20		2.16	54.86	2.11	53.67	0.88	22.23	1.14	29.06
	03	46		2.52	64.01	1.33	33.83	0.35	8.89	0.63	15.88
	04	59		2.52	64.01	1.77	44.96	0.63	15.88	0.94	23.80
	05	73*		2.57	65.28	2.12	53.75	0.88	22.23	1.25	31.75
28	01	21	28	2.57	65.28	1.77	44.96	0.63	15.88	0.94	23.80
	02	22		2.22	56.39	2.36	60.02	1.00	25.40	1.38	34.93
	03	60		2.57	65.28	1.55	39.40	0.50	12.70	0.75	19.05
	04	61		2.57	65.28	2.11	53.67	0.88	22.23	1.25	31.75
32	01	23	32	2.67	67.82	1.77	44.96	0.63	15.88	0.94	23.80
	02	24		2.67	67.82	2.11	53.67	0.88	22.23	1.25	31.75
	03	25		2.32	58.93	2.77	70.36	1.25	31.75	1.63	41.28
	04	62		2.67	67.82	2.36	60.02	1.00	25.40	1.38	34.93

Table Continued



Connector Group - J

90°, 45°

TABLE - B											
AMPHENOL PART NUMBER DESIGNATOR		MIL PART NUMBER DESIGNATOR	CONNECTOR SHELL SIZE	F (MAX)		G (MAX)		CABLE RANGE			
SHELL SIZE	ENTRY SIZE	DASH NO		INCH	MM	INCH	MM	MIN		MAX	
								INCH	MM	INCH	MM
32	01	23	32	2.67	67.82	1.77	44.96	0.63	15.88	0.94	23.80
	02	24		2.67	67.82	2.11	53.67	0.88	22.23	1.25	31.75
	03	25		2.32	58.93	2.77	70.36	1.25	31.75	1.63	41.28
	04	62		2.67	67.82	2.36	60.02	1.00	25.40	1.38	34.93
36	01	26	36	2.76	70.10	1.77	44.96	0.63	15.88	0.94	23.80
	02	27		2.76	70.10	2.36	60.02	1.00	25.40	1.38	34.93
	03	28		2.41	61.21	3.02	76.71	1.44	36.50	1.84	46.74
	04	47		2.76	70.10	1.55	39.40	0.50	12.70	0.75	19.05
	05	63		2.76	70.10	2.11	53.67	0.88	22.23	1.25	31.75
	06	64		2.76	70.10	2.77	70.36	1.25	31.75	1.63	41.28
40	01	29	40	2.76	70.10	1.77	44.96	0.63	15.88	0.94	23.80
	02	30		2.76	70.10	2.36	60.02	1.00	25.40	1.38	34.93
	03	31		2.41	61.21	3.02	76.71	1.44	36.50	1.88	47.63
	04	48		2.76	70.10	1.55	39.40	0.50	12.70	0.75	19.05
	05	65		2.76	70.10	2.11	53.67	0.88	22.23	1.25	31.75
	06	66		2.76	70.10	2.77	70.36	1.25	31.75	1.63	41.28
44	01	32	44	2.76	70.10	1.77	44.96	0.63	15.88	0.94	23.80
	02	33		2.76	70.10	2.36	60.02	1.00	25.40	1.38	34.93
	03	34		2.41	61.21	3.02	76.71	1.44	36.50	1.88	47.63
	04	67		2.76	70.10	2.11	53.67	0.88	22.23	1.25	31.75
	05	68		2.76	70.10	2.77	70.36	1.25	31.75	1.63	41.28
48	01	35	48	2.76	70.10	1.77	44.96	0.63	15.88	0.94	23.80
	02	36		2.76	70.10	2.36	60.02	1.00	25.40	1.38	34.93
	03	37		2.41	61.21	3.02	76.71	1.44	36.50	1.88	47.63
	04	69		2.76	70.10	2.11	53.67	0.88	22.23	1.25	31.75
	05	70		2.76	70.10	2.77	70.36	1.25	31.75	1.63	41.28





## Connector Group - K

## Straight



NOTE: \* For more cable entry and length options, contact factory

AMPHENOL PART NUMBER DESIGNATOR			MIL PART NUMBER DESIGNATOR			CONNECTOR SHELL SIZE SE - II / I	CABLE RANGE				L (MAX)		Y (MAX)	
SHELL SIZE	ENTRY SIZE	LENGTH	ACCESSORY SHELL SIZE	CLAMP SIZE	LENGTH		MIN		MAX		INCH	MM	INCH	MM
							INCH	MM	INCH	MM				
08	01	1	08	1	STD.	8 / 9	0.06	1.57	0.13	3.18	1.53	38.86	0.78	19.81
		A			2.53						64.26			
	02	1		2	STD.		0.13	3.18	0.25	6.35	1.53	38.86	0.97	24.64
		A			2.53						64.26			
10	01	1	10	1	STD.	10 / 11	0.06	1.57	0.13	3.18	1.53	38.86	0.78	19.81
		A			2.53						64.26			
	02	1		2	STD.		0.13	3.18	0.25	6.35	1.53	38.86	0.97	24.64
		A			2.53						64.26			
	03	1		2	STD.		0.25	6.35	0.38	9.53	1.53	38.86	1.06	26.92
		A			2.53						64.26			
12	01	1	12	2	STD.	12 / 13	0.13	3.18	0.25	6.35	1.53	38.86	0.97	24.64
		A			2.53						64.26			
	02	1		3	STD.		0.25	6.35	0.38	9.53	1.53	38.86	1.06	26.92
		A			2.53						64.26			
	03	1		2	STD.		0.31	7.92	0.50	12.70	1.53	38.86	1.16	29.46
		A			2.53						64.26			
14	01	1	14	2	STD.	14 / 15	0.13	3.18	0.25	6.35	1.53	38.86	0.97	24.64
		A			2.53						64.26			
		B			3.53						89.66			
	02	1		3	STD.		0.25	6.35	0.38	9.53	1.53	38.86	1.06	26.92
		A			2.53						64.26			
		B			3.53						89.66			
	03	1		2	STD.		0.31	7.92	0.50	12.70	1.53	38.86	1.16	29.46
		A			2.53						64.26			
		B			3.53						89.66			
	04	1		3	STD.		0.44	11.10	0.63	15.88	1.53	38.86	1.25	31.75
		A			2.53						64.26			
		B			3.53						89.66			

Table Continued

Connector Group - K

Straight

TABLE - A															
AMPHENOL PART NUMBER DESIGNATOR			MIL PART NUMBER DESIGNATOR			CONNECTOR SHELL SIZE SE - II / I	CABLE RANGE				L (MAX)		Y (MAX)		
SHELL SIZE	ENTRY SIZE	LENGTH	ACCESSORY SHELL SIZE	CLAMP SIZE	LENGTH		MIN		MAX		INCH	MM	INCH	MM	
							INCH	MM	INCH	MM					
16	01	1	16	2	STD.	16 / 17	0.13	3.18	0.25	6.35	1.53	38.86	0.97	24.64	
		2			A						2.53	64.26			
		3			B						3.53	89.66			
	02	1			3		STD.	0.25	6.35	0.38	9.53	1.53	38.86	1.06	26.92
		2					A					2.53	64.26		
		3					B					3.53	89.66		
	03	1		4	STD.		0.31	7.92	0.50	12.70	1.53	38.86	1.16	29.46	
		2			A						2.53	64.26			
		3			B						3.53	89.66			
	04	1		5	STD.		0.44	11.10	0.63	15.88	1.53	38.86	1.25	31.75	
		2			A						2.53	64.26			
		3			B						3.53	89.66			
05	1	6	STD.	0.56	14.27	0.75	19.05	1.53	38.86	1.38	35.05				
	2		A					2.53	64.26						
	3		B					3.53	89.66						
18	01	1	18	3	STD.	18 / 19	0.25	6.35	0.38	9.53	1.53	38.86	1.06	26.92	
		2			A						2.53	64.26			
		3			B						3.53	89.66			
	02	1			4		STD.	0.31	7.92	0.50	12.70	1.53	38.86	1.16	29.46
		2					A					2.53	64.26		
		3					B					3.53	89.66		
	03	1		5	STD.		0.44	11.10	0.63	15.88	1.53	38.86	1.25	31.75	
		2			A						2.53	64.26			
		3			B						3.53	89.66			
	04	1		6	STD.		0.56	14.27	0.75	19.05	1.53	38.86	1.38	35.05	
		2			A						2.53	64.26			
		3			B						3.53	89.66			
05	1	7	STD.	0.69	17.45	0.88	22.23	1.53	38.86	1.50	38.10				
	2		A					2.53	64.26						
	3		B					3.53	89.66						
20	01	1	20	3	STD.	20 / 21	0.25	6.35	0.38	9.53	1.53	38.86	1.06	26.92	
		2			A						2.53	64.26			
		3			B						3.53	89.66			
		4			C						4.53	115.06			
	02	1			4		STD.	0.31	7.92	0.50	12.70	1.53	38.86	1.16	29.46
		2					A					2.53	64.26		
		3					B					3.53	89.66		
		4					C					4.53	115.06		
	03	1			5		STD.	0.44	11.10	0.63	15.88	1.53	38.86	1.25	31.75
		2					A					2.53	64.26		
		3					B					3.53	89.66		
		4					C					4.53	115.06		
	04	1		6	STD.		0.56	14.27	0.75	19.05	1.53	38.86	1.38	35.05	
		2			A						2.53	64.26			
		3			B						3.53	89.66			
		4			C						4.53	115.06			
	05	1		7	STD.		0.69	17.45	0.88	22.23	1.53	38.86	1.50	38.10	
		2			A						2.53	64.26			
		3			B						3.53	89.66			
		4			C						4.53	115.06			
	06	1		8	STD.		0.81	20.62	1.00	25.40	1.53	38.86	1.63	41.40	
		2			A						2.53	64.26			
		3			B						3.53	89.66			
		4			C						4.53	115.06			

Table Continued



### Connector Group - K

### Straight

TABLE - A

AMPHENOL PART NUMBER DESIGNATOR			MIL PART NUMBER DESIGNATOR			CONNECTOR SHELL SIZE SE - II / I	CABLE RANGE				L (MAX)		Y (MAX)				
SHELL SIZE	ENTRY SIZE	LENGTH	ACCESSORY SHELL SIZE	CLAMP SIZE	LENGTH		MIN		MAX		INCH	MM	INCH	MM			
							INCH	MM	INCH	MM							
22	01	1	22	3	STD.	22 / 23	0.25	6.35	0.38	9.53	1.53	38.86	1.06	26.92			
		2			A						2.53	64.26					
		3			B						3.53	89.66					
		4			C						4.53	115.06					
	02	1		4	STD.		4	1.53	38.86	0.31	7.92	0.50	12.70	2.53	64.26	1.16	29.46
		2			A			3.53	89.66								
		3			B			4.53	115.06								
		4			C			1.53	38.86								
	03	1		5	STD.		5	1.53	38.86	0.44	11.10	0.63	15.88	2.53	64.26	1.25	31.75
		2			A			3.53	89.66								
		3			B			4.53	115.06								
		4			C			1.53	38.86								
	04	1		6	STD.		6	1.53	38.86	0.56	14.27	0.75	19.05	2.53	64.26	1.38	35.05
		2			A			3.53	89.66								
		3			B			4.53	115.06								
		4			C			1.53	38.86								
	05	1		7	STD.		7	1.53	38.86	0.69	17.45	0.88	22.23	2.53	64.26	1.50	38.10
		2			A			3.53	89.66								
		3			B			4.53	115.06								
		4			C			1.53	38.86								
	06	1		8	STD.		8	1.53	38.86	0.81	20.62	1.00	25.40	2.53	64.26	1.63	41.40
		2			A			3.53	89.66								
		3			B			4.53	115.06								
		4			C			1.53	38.86								
	07	1		9	STD.		9	1.53	38.86	0.94	23.80	1.13	28.58	2.53	64.26	1.75	44.45
		2			A			3.53	89.66								
		3			B			4.53	115.06								
		4			C			1.53	38.86								
24	01	1	24	4	STD.	24 / 25	0.31	7.92	0.50	12.70	1.53	38.86	1.16	29.46			
		2			A						2.53	64.26					
		3			B						3.53	89.66					
		4			C						4.53	115.06					
	02	1		5	STD.		5	1.53	38.86	0.44	11.10	0.63	15.88	2.53	64.26	1.25	31.75
		2			A			3.53	89.66								
		3			B			4.53	115.06								
		4			C			1.53	38.86								
	03	1		6	STD.		6	1.53	38.86	0.56	14.27	0.75	19.05	2.53	64.26	1.38	35.05
		2			A			3.53	89.66								
		3			B			4.53	115.06								
		4			C			1.53	38.86								
	04	1		7	STD.		7	1.53	38.86	0.69	17.45	0.88	22.23	2.53	64.26	1.50	38.10
		2			A			3.53	89.66								
		3			B			4.53	115.06								
		4			C			1.53	38.86								
	05	1		8	STD.		8	1.53	38.86	0.81	20.62	1.00	25.40	2.53	64.26	1.63	41.40
		2			A			3.53	89.66								
		3			B			4.53	115.06								
		4			C			1.53	38.86								
	06	1		9	STD.		9	1.53	38.86	0.94	23.80	1.13	28.58	2.53	64.26	1.75	44.45
		2			A			3.53	89.66								
		3			B			4.53	115.06								
		4			C			1.53	38.86								
	07	1		10	STD.		10	1.53	38.86	1.06	26.97	1.25	31.75	2.53	64.26	1.88	47.75
		2			A			3.53	89.66								
		3			B			4.53	115.06								
		4			C			1.53	38.86								

### Connector Group - K

90°, 45°

#### Amphenol Part Number



NOTE: \* For more cable entry options, contact factory

TABLE - B

AMPHENOL PART NUMBER DESIGNATOR	MIL PART NUMBER DESIGNATOR		CONNECTOR SHELL SIZE SE - II / I	CABLE RANGE				A DIA. (MAX)		B (MAX)		C (MAX)		D (MAX)		E (MAX)		Y (MAX)		
				MIN		MAX		INCH	MM	INCH	MM	INCH	MM	INCH	MM	INCH	MM	INCH	MM	
				INCH	MM	INCH	MM													
08	01	08	1	8 / 9	0.06	1.57	0.13	3.18	0.75	19.05	0.46	11.68	3.15	80.01	0.69	17.53	3.46	87.88	0.78	19.81
	02		2		0.13	3.18	0.25	6.35											0.97	24.64
10	01	10	1	10 / 11	0.06	1.57	0.13	3.18	0.85	21.59	0.52	13.21	3.21	81.53	0.78	19.81	3.58	90.93	0.78	19.81
	02		2		0.13	3.18	0.25	6.35											0.97	24.64
	03		3		0.25	6.35	0.38	9.53											1.06	26.92
12	01	12	2	12 / 13	0.13	3.18	0.25	6.35	1.00	25.40	0.58	14.73	3.27	83.06	0.80	20.32	3.60	91.44	0.97	24.64
	02		3		0.25	6.35	0.38	9.53											1.06	26.92
	03		4		0.31	7.92	0.50	12.70											1.16	29.46
14	01	14	2	14 / 15	0.13	3.18	0.25	6.35	1.15	29.21	0.65	16.51	3.36	85.34	0.88	22.35	3.67	93.22	0.97	24.64
	02		3		0.25	6.35	0.38	9.53											1.06	26.92
	03		4		0.31	7.92	0.50	12.70											1.16	29.46
	04		5		0.44	11.10	0.63	15.88											1.25	31.75
16	01	16	2	16 / 17	0.13	3.18	0.25	6.35	1.25	31.75	0.74	18.80	3.47	88.14	0.93	23.62	3.76	95.50	0.97	24.64
	02		3		0.25	6.35	0.38	9.53											1.06	26.92
	03		4		0.31	7.92	0.50	12.70											1.16	29.46
	04		5		0.44	11.10	0.63	15.88											1.25	31.75
	05		6		0.56	14.27	0.75	19.05											1.38	35.05
18	01	18	3	18 / 19	0.25	6.35	0.38	9.53	1.40	35.56	0.93	23.62	3.66	92.96	1.01	25.65	3.93	99.82	1.06	26.92
	02		4		0.31	7.92	0.50	12.70											1.16	29.46
	03		5		0.44	11.10	0.63	15.88											1.25	31.75
	04		6		0.56	14.27	0.75	19.05											1.38	35.05
	05		7		0.69	17.45	0.88	22.23											1.50	38.10
20	01	20	3	20 / 21	0.25	6.35	0.38	9.53	1.55	39.37	0.93	23.62	3.66	92.96	1.06	26.92	3.93	99.82	1.06	26.92
	02		4		0.31	7.92	0.50	12.70											1.16	29.46
	03		5		0.44	11.10	0.63	15.88											1.25	31.75
	04		6		0.56	14.27	0.75	19.05											1.38	35.05
	05		7		0.69	17.45	0.88	22.23											1.50	38.10
	06		8		0.81	20.62	1.00	25.40											1.63	41.40

Table Continued

Connector Group - K

90°, 45°

TABLE - B

AMPHENOL PART NUMBER DESIGNATOR		MIL PART NUMBER DESIGNATOR		CONNECTOR SHELL SIZE SE - II / I	CABLE RANGE				A DIA. (MAX)		B (MAX)		C (MAX)		D (MAX)		E (MAX)		Y (MAX)	
SHELL SIZE	ENTRY SIZE	SHELL SIZE	CLAMP SIZE		MIN		MAX		INCH	MM	INCH	MM	INCH	MM	INCH	MM	INCH	MM	INCH	MM
					INCH	MM	INCH	MM												
22	01	22	3	22 / 23	0.25	6.35	0.38	9.53	1.65	41.91	1.02	25.91	3.81	96.77	1.17	29.72	4.04	102.62	1.06	26.92
	02		4		0.31	7.92	0.50	12.70											1.16	29.46
	03		5		0.44	11.10	0.63	15.88											1.25	31.75
	04		6		0.56	14.27	0.75	19.05											1.38	35.05
	05		7		0.69	17.45	0.88	22.23											1.50	38.10
	06		8		0.81	20.62	1.00	25.40											1.63	41.40
	07		9		0.94	23.80	1.13	28.58											1.75	44.45
24	01	24	4	24 / 25	0.31	7.92	0.50	12.70	1.85	46.99	1.02	25.91	3.81	96.77	1.18	29.97	4.04	102.62	1.16	29.46
	02		5		0.44	11.10	0.63	15.88											1.25	31.75
	03		6		0.56	14.27	0.75	19.05											1.38	35.05
	04		7		0.69	17.45	0.88	22.23											1.50	38.10
	05		8		0.81	20.62	1.00	25.40											1.63	41.40
	06		9		0.94	23.80	1.13	28.58											1.75	44.45
	07		10		1.06	26.97	1.25	31.75											1.88	47.75



### Connector Group - L

### Straight



**NOTE:** \* For more cable entry and length options, contact factory

AMPHENOL PART NUMBER DESIGNATOR		MIL PART NUMBER DESIGNATOR				CONNECTOR SHELL SIZE/CODE (REF.)	CABLE RANGE				A DIA. (MAX)		L (MAX)		Y (MAX)		
SHELL SIZE	ENTRY SIZE	LENGTH	CONNECTOR SHELL SIZE	CLAMP SIZE	LENGTH		MIN		MAX		INCH	MM	INCH	MM	INCH	MM	
							INCH	MM	INCH	MM							
08	01	1	09	1	STD.	09 / A	0.06	1.57	0.13	3.18	0.75	19.05	1.53	38.86	0.80	20.32	
		2			A								2.53	64.26			
	02	1		STD.	0.13		3.18	0.25	6.35	1.53			38.86	1.00	25.40		
		2		A						2.53			64.26				
10	01	1	11	1	STD.	11 / B	0.06	1.57	0.13	3.18	0.85	21.59	1.53	38.86	0.80	20.32	
		2			A								2.53	64.26			
	02	1		STD.	0.13		3.18	0.25	6.35	1.53			38.86	1.00	25.40		
		2		A						2.53			64.26				
	03	1		1	3		STD.	0.25	6.35	0.38			9.53	1.53	38.86	1.10	27.94
				2			A							2.53	64.26		
02		1	STD.	0.31		7.92	0.50				12.70	1.53		38.86	1.20	30.48	
		2	A									2.53		64.26			
12	01	1	13	2	STD.	13 / C	0.13	3.18	0.25	6.35	1.00	25.40	1.53	38.86	1.00	25.40	
		2			A								2.53	64.26			
	02	1		STD.	0.25		6.35	0.38	9.53	1.53			38.86	1.10	27.94		
		2		A						2.53			64.26				
	03	1		1	4		STD.	0.31	7.92	0.50			12.70	1.53	38.86	1.20	30.48
				2			A							2.53	64.26		
02		1	STD.	0.44		11.10	0.63				15.88	1.53		38.86	1.25	31.75	
		2	A									2.53		64.26			
14	01	1	15	2	STD.	15 / D	0.13	3.18	0.25	6.35	1.10	27.94	1.53	38.86	1.00	25.40	
		2			A								2.53	64.26			
		3			B								3.53	89.66			
	02	1		STD.	3		A	0.25	6.35	0.38			9.53	1.53	38.86	1.10	27.94
		2		A										2.53	64.26		
		3		B										3.53	89.66		
	03	1		1	4		STD.	0.31	7.92	0.50			12.70	1.53	38.86	1.20	30.48
				2										A	2.53		
		3		B			3.53							89.66			
	04	1		1	5		STD.	0.44	11.10	0.63			15.88	1.53	38.86	1.25	31.75
				2										A	2.53		
		3		B			3.53							89.66			

Table Continued



### Connector Group - L

### Straight

TABLE - A

AMPHENOL PART NUMBER DESIGNATOR			MIL PART NUMBER DESIGNATOR			CONNECTOR SHELL SIZE/CODE (REF.)	CABLE RANGE				A DIA. (MAX)		L (MAX)		Y (MAX)		
SHELL SIZE	ENTRY SIZE	LENGTH	CONNECTOR SHELL SIZE	CLAMP SIZE	LENGTH		MIN		MAX		INCH	MM	INCH	MM	INCH	MM	
							INCH	MM	INCH	MM							
16	01	1	17	2	STD.	17 / E	0.13	3.18	0.25	6.35	1.25	31.75	1.53	38.86	1.00	25.40	
		2			A								2.53	64.26			
		3			B								3.53	89.66			
	02	1		STD.	3		STD.	0.25	6.35	0.38			9.53	1.53	38.86	1.10	27.94
		2		A			2.53							64.26			
		3		B			3.53							89.66			
	03	1		STD.	4		STD.	0.31	7.92	0.50			12.70	1.53	38.86	1.20	30.48
		2		A			2.53							64.26			
		3		B			3.53							89.66			
	04	1		STD.	5		STD.	0.44	11.10	0.63			15.88	1.53	38.86	1.25	31.75
		2		A			2.53							64.26			
		3		B			3.53							89.66			
05	1	STD.	6	STD.	0.56	14.27	0.75	19.05	1.53	38.86	1.40	35.56					
	2	A		2.53					64.26								
	3	B		3.53					89.66								
18	01	1	19	3	STD.	19 / F	0.25	6.35	0.38	9.53	1.40	35.56	1.53	38.86	1.10	27.94	
		2			A								2.53	64.26			
		3			B								3.53	89.66			
	02	1		STD.	4		STD.	0.31	7.92	0.50			12.70	1.53	38.86	1.20	30.48
		2		A			2.53							64.26			
		3		B			3.53							89.66			
	03	1		STD.	5		STD.	0.44	11.10	0.63			15.88	1.53	38.86	1.25	31.75
		2		A			2.53							64.26			
		3		B			3.53							89.66			
	04	1		STD.	6		STD.	0.56	14.27	0.75			19.05	1.53	38.86	1.40	35.56
		2		A			2.53							64.26			
		3		B			3.53							89.66			
05	1	STD.	7	STD.	0.69	17.45	0.88	22.23	1.53	38.86	1.50	38.10					
	2	A		2.53					64.26								
	3	B		3.53					89.66								
20	01	1	21	3	STD.	21 / G	0.25	6.35	0.38	9.53	1.50	38.10	1.53	38.86	1.10	27.94	
		2			A								2.53	64.26			
		3			B								3.53	89.66			
		4			C								4.53	115.06			
	02	1		STD.	4		STD.	0.31	7.92	0.50			12.70	1.53	38.86	1.20	30.48
		2		A			2.53							64.26			
		3		B			3.53							89.66			
		4		C			4.53							115.06			
	03	1		STD.	5		STD.	0.44	11.10	0.63			15.88	1.53	38.86	1.25	31.75
		2		A			2.53							64.26			
		3		B			3.53							89.66			
		4		C			4.53							115.06			
	04	1		STD.	6		STD.	0.56	14.27	0.75			19.05	1.53	38.86	1.40	35.56
		2		A			2.53							64.26			
		3		B			3.53							89.66			
		4		C			4.53							115.06			
	05	1		STD.	7		STD.	0.69	17.45	0.88			22.23	1.53	38.86	1.50	38.10
		2		A			2.53							64.26			
		3		B			3.53							89.66			
		4		C			4.53							115.06			
	06	1		STD.	8		STD.	0.81	20.62	1.00			25.40	1.53	38.86	1.65	41.91
		2		A			2.53							64.26			
		3		B			3.53							89.66			
		4		C			4.53							115.06			

Table Continued



### Connector Group - L

### Straight

TABLE - A

AMPHENOL PART NUMBER DESIGNATOR			MIL PART NUMBER DESIGNATOR			CONNECTOR SHELL SIZE/CODE (REF.)	CABLE RANGE				A DIA. (MAX)		L (MAX)		Y (MAX)		
SHELL SIZE	ENTRY SIZE	LENGTH	CONNECTOR SHELL SIZE	CLAMP SIZE	LENGTH		MIN		MAX		INCH	MM	INCH	MM	INCH	MM	
							INCH	MM	INCH	MM							
22	01	1	23	3	STD.	23 / H	0.25	6.35	0.38	9.53	1.65	41.91	1.53	38.86	1.10	27.94	
		2			A								2.53	64.26			
		3			B								3.53	89.66			
		4			C								4.53	115.06			
	02	1		STD.	4		STD.	0.31	7.92	0.50			12.70	1.53	38.86	1.20	30.48
		2		A			2.53							64.26			
		3		B			3.53							89.66			
		4		C			4.53							115.06			
	03	1		STD.	5		STD.	0.44	11.10	0.63			15.88	1.53	38.86	1.25	31.75
		2		A			2.53							64.26			
		3		B			3.53							89.66			
		4		C			4.53							115.06			
	04	1		STD.	6		STD.	0.56	14.27	0.75			19.05	1.53	38.86	1.40	35.56
		2		A			2.53							64.26			
		3		B			3.53							89.66			
		4		C			4.53							115.06			
	05	1		STD.	7		STD.	0.69	17.45	0.88			22.23	1.53	38.86	1.50	38.10
		2		A			2.53							64.26			
		3		B			3.53							89.66			
		4		C			4.53							115.06			
	06	1		STD.	8		STD.	0.81	20.62	1.00			25.40	1.53	38.86	1.65	41.91
		2		A			2.53							64.26			
		3		B			3.53							89.66			
		4		C			4.53							115.06			
	07	1		STD.	9		STD.	0.94	23.80	1.13			28.58	1.53	38.86	1.75	44.45
		2		A			2.53							64.26			
		3		B			3.53							89.66			
		4		C			4.53							115.06			
24	01	1	25	4	STD.	25 / J	0.31	7.92	0.50	12.70	1.75	44.45	1.53	38.86	1.20	30.48	
		2			A								2.53	64.26			
		3			B								3.53	89.66			
		4			C								4.53	115.06			
	02	1		STD.	5		STD.	0.44	11.10	0.63			15.88	1.53	38.86	1.25	31.75
		2		A			2.53							64.26			
		3		B			3.53							89.66			
		4		C			4.53							115.06			
	03	1		STD.	6		STD.	0.56	14.27	0.75			19.05	1.53	38.86	1.40	35.56
		2		A			2.53							64.26			
		3		B			3.53							89.66			
		4		C			4.53							115.06			
	04	1		STD.	7		STD.	0.69	17.45	0.88			22.23	1.53	38.86	1.50	38.10
		2		A			2.53							64.26			
		3		B			3.53							89.66			
		4		C			4.53							115.06			
	05	1		STD.	8		STD.	0.81	20.62	1.00			25.40	1.53	38.86	1.65	41.91
		2		A			2.53							64.26			
		3		B			3.53							89.66			
		4		C			4.53							115.06			
	06	1		STD.	9		STD.	0.94	23.80	1.13			28.58	1.53	38.86	1.75	44.45
		2		A			2.53							64.26			
		3		B			3.53							89.66			
		4		C			4.53							115.06			
	07	1		STD.	10		STD.	1.06	26.97	1.25			31.75	1.53	38.86	1.90	48.26
		2		A			2.53							64.26			
		3		B			3.53							89.66			
		4		C			4.53							115.06			



### Connector Group - L

90°, 45°



#### Amphenol Part Number



NOTE: \* For more cable entry options, contact factory

TABLE - B

AMPHENOL PART NUMBER DESIGNATOR		CONNECTOR SHELL SIZE/CODE (REF.)	CABLE RANGE				A DIA. (MAX)		B (MAX)		C (MAX)		D (MAX)		E (MAX)		Y (MAX)	
SHELL SIZE	ENTRY SIZE		MIN		MAX		INCH	MM	INCH	MM	INCH	MM	INCH	MM	INCH	MM	INCH	MM
			INCH	MM	INCH	MM												
08	01	09 / A	0.06	1.57	0.13	3.18	0.75	19.05	0.46	11.68	3.15	80.01	0.69	17.53	3.46	87.88	0.80	20.32
	02		0.13	3.18	0.25	6.35											1.00	25.40
10	01	11 / B	0.06	1.57	0.13	3.18	0.85	21.59	0.52	13.21	3.21	81.53	0.78	19.81	3.58	90.93	0.80	20.32
	02		0.13	3.18	0.25	6.35											1.00	25.40
	03		0.25	6.35	0.38	9.53											1.10	27.94
12	01	13 / C	0.13	3.18	0.25	6.35	1.00	25.40	0.58	14.73	3.27	83.06	0.80	20.32	3.60	91.44	1.00	25.40
	02		0.25	6.35	0.38	9.53											1.10	27.94
	03		0.31	7.92	0.50	12.70											1.20	30.48
14	01	15 / D	0.13	3.18	0.25	6.35	1.15	29.21	0.65	16.51	3.36	85.34	0.88	22.35	3.67	93.22	1.00	25.40
	02		0.25	6.35	0.38	9.53											1.10	27.94
	03		0.31	7.92	0.50	12.70											1.20	30.48
	04		0.44	11.10	0.63	15.88											1.25	31.75
16	01	17 / E	0.13	3.18	0.25	6.35	1.25	31.75	0.74	18.80	3.47	88.14	0.93	23.62	3.76	95.50	1.00	25.40
	02		0.25	6.35	0.38	9.53											1.10	27.94
	03		0.31	7.92	0.50	12.70											1.20	30.48
	04		0.44	11.10	0.63	15.88											1.25	31.75
	05		0.56	14.27	0.75	19.05											1.40	35.56
18	01	19 / F	0.25	6.35	0.38	9.53	1.40	35.56	0.93	23.62	3.66	92.96	1.01	25.65	3.93	99.82	1.10	27.94
	02		0.31	7.92	0.50	12.70											1.20	30.48
	03		0.44	11.10	0.63	15.88											1.25	31.75
	04		0.56	14.27	0.75	19.05											1.40	35.56
	05		0.69	17.45	0.88	22.23											1.50	38.10

Table Continued

Connector Group - L

90°, 45°

TABLE - B

AMPHENOL PART NUMBER DESIGNATOR		CONNECTOR SHELL SIZE/CODE (REF.)	CABLE RANGE				A DIA. (MAX)		B (MAX)		C (MAX)		D (MAX)		E (MAX)		Y (MAX)	
SHELL SIZE	ENTRY SIZE		MIN		MAX		INCH	MM	INCH	MM	INCH	MM	INCH	MM	INCH	MM	INCH	MM
			INCH	MM	INCH	MM												
20	01	21 / G	0.25	6.35	0.38	9.53	1.55	39.37	0.93	23.62	3.66	92.96	1.06	26.92	3.93	99.82	1.10	27.94
	02		0.31	7.92	0.50	12.70											1.20	30.48
	03		0.44	11.10	0.63	15.88											1.25	31.75
	04		0.56	14.27	0.75	19.05											1.40	35.56
	05		0.69	17.45	0.88	22.23											1.50	38.10
	06		0.81	20.62	1.00	25.40											1.65	41.91
22	01	23 / H	0.25	6.35	0.38	9.53	1.65	41.91	1.02	25.91	3.81	96.77	1.17	29.72	4.04	102.62	1.10	27.94
	02		0.31	7.92	0.50	12.70											1.20	30.48
	03		0.44	11.10	0.63	15.88											1.25	31.75
	04		0.56	14.27	0.75	19.05											1.40	35.56
	05		0.69	17.45	0.88	22.23											1.50	38.10
	06		0.81	20.62	1.00	25.40											1.65	41.91
	07		0.94	23.80	1.13	28.58											1.75	44.45
24	01	25 / J	0.31	7.92	0.50	12.70	1.85	46.99	1.02	25.91	3.81	96.77	1.18	29.97	4.04	102.62	1.20	30.48
	02		0.44	11.10	0.63	15.88											1.25	31.75
	03		0.56	14.27	0.75	19.05											1.40	35.56
	04		0.69	17.45	0.88	22.23											1.50	38.10
	05		0.81	20.62	1.00	25.40											1.65	41.91
	06		0.94	23.80	1.13	28.58											1.75	44.45
	07		1.06	26.97	1.25	31.75											1.90	48.26



### Connector Group - M

### Straight



**NOTE:** \* For more cable entry and length options, contact factory

TABLE - A											
AMPHENOL PART NUMBER DESIGNATOR			CONNECTOR SHELL SIZE	CABLE RANGE				L (MAX)		Y (MAX)	
SHELL SIZE	ENTRY SIZE	LENGTH		MIN		MAX		INCH	MM	INCH	MM
				INCH	MM	INCH	MM				
08	01	1	8	0.06	1.57	0.13	3.18	1.53	38.86	0.78	19.81
		2						2.53	64.26		
	02	1		0.13	3.18	0.25	6.35	1.53	38.86	0.97	24.64
		2						2.53	64.26		
10	01	1	10	0.06	1.57	0.13	3.18	1.53	38.86	0.78	19.81
		2						2.53	64.26		
	02	1		0.13	3.18	0.25	6.35	1.53	38.86	0.97	24.64
		2						2.53	64.26		
	03	1		0.25	6.35	0.38	9.53	1.53	38.86	1.06	26.92
		2						2.53	64.26		
12	01	1	12	0.13	3.18	0.25	6.35	1.53	38.86	0.97	24.64
		2						2.53	64.26		
	02	1		0.25	6.35	0.38	9.53	1.53	38.86	1.06	26.92
		2						2.53	64.26		
	03	1		0.31	7.92	0.50	12.70	1.53	38.86	1.16	29.46
		2						2.53	64.26		
14	01	1	14	0.13	3.18	0.25	6.35	1.53	38.86	0.97	24.64
		2						2.53	64.26		
		3						3.53	89.66		

Table Continued

Connector Group - M

Straight

TABLE - A											
AMPHENOL PART NUMBER DESIGNATOR			CONNECTOR SHELL SIZE	CABLE RANGE				L (MAX)		Y (MAX)	
SHELL SIZE	ENTRY SIZE	LENGTH		MIN		MAX		INCH	MM	INCH	MM
				INCH	MM	INCH	MM				
14	02	1	14	0.25	6.35	0.38	9.53	1.53	38.86	1.06	26.92
		2						2.53	64.26		
		3						3.53	89.66		
	03	1		0.31	7.92	0.50	12.70	1.53	38.86	1.16	29.46
		2						2.53	64.26		
		3						3.53	89.66		
	04	1		0.44	11.10	0.63	15.88	1.53	38.86	1.25	31.75
		2						2.53	64.26		
		3						3.53	89.66		
16	01	1	16	0.13	3.18	0.25	6.35	1.53	38.86	0.97	24.64
		2						2.53	64.26		
		3						3.53	89.66		
	02	1		0.25	6.35	0.38	9.53	1.53	38.86	1.06	26.92
		2						2.53	64.26		
		3						3.53	89.66		
	03	1		0.31	7.92	0.50	12.70	1.53	38.86	1.16	29.46
		2						2.53	64.26		
		3						3.53	89.66		
	04	1		0.44	11.10	0.63	15.88	1.53	38.86	1.25	31.75
		2						2.53	64.26		
		3						3.53	89.66		
	05	1		0.56	14.27	0.75	19.05	1.53	38.86	1.38	35.05
		2						2.53	64.26		
		3						3.53	89.66		
18	01	1	18	0.25	6.35	0.38	9.53	1.53	38.86	1.06	26.92
		2						2.53	64.26		
		3						3.53	89.66		
	02	1		0.31	7.92	0.50	12.70	1.53	38.86	1.16	29.46
		2						2.53	64.26		
		3						3.53	89.66		
	03	1		0.44	11.10	0.63	15.88	1.53	38.86	1.25	31.75
		2						2.53	64.26		
		3						3.53	89.66		
	04	1		0.56	14.27	0.75	19.05	1.53	38.86	1.38	35.05
		2						2.53	64.26		
		3						3.53	89.66		
	05	1		0.69	17.45	0.88	22.23	1.53	38.86	1.50	38.10
		2						2.53	64.26		
		3						3.53	89.66		

Table Continued





TABLE - A											
AMPHENOL PART NUMBER DESIGNATOR			CONNECTOR SHELL SIZE	CABLE RANGE				L (MAX)		Y (MAX)	
SHELL SIZE	ENTRY SIZE	LENGTH		MIN		MAX		INCH	MM	INCH	MM
				INCH	MM	INCH	MM				
20	01	1	20	0.25	6.35	0.38	9.53	1.53	38.86	1.06	26.92
		2						2.53	64.26		
		3						3.53	89.66		
		4						4.53	115.06		
	02	1		0.31	7.92	0.50	12.70	1.53	38.86	1.16	29.46
		2						2.53	64.26		
		3						3.53	89.66		
		4						4.53	115.06		
	03	1		0.44	11.10	0.63	15.88	1.53	38.86	1.25	31.75
		2						2.53	64.26		
		3						3.53	89.66		
		4						4.53	115.06		
	04	1		0.56	14.27	0.75	19.05	1.53	38.86	1.38	35.05
		2						2.53	64.26		
		3						3.53	89.66		
		4						4.53	115.06		
	05	1		0.69	17.45	0.88	22.23	1.53	38.86	1.50	38.10
		2						2.53	64.26		
		3						3.53	89.66		
		4						4.53	115.06		
	06	1		0.81	20.62	1.00	25.40	1.53	38.86	1.63	41.40
		2						2.53	64.26		
		3						3.53	89.66		
		4						4.53	115.06		
22	01	1	22	0.25	6.35	0.38	9.53	1.53	38.86	1.06	26.92
		2						2.53	64.26		
		3						3.53	89.66		
		4						4.53	115.06		
	02	1		0.31	7.92	0.50	12.70	1.53	38.86	1.16	29.46
		2						2.53	64.26		
		3						3.53	89.66		
		4						4.53	115.06		
	03	1		0.44	11.10	0.63	15.88	1.53	38.86	1.25	31.75
		2						2.53	64.26		
		3						3.53	89.66		
		4						4.53	115.06		
	04	1		0.56	14.27	0.75	19.05	1.53	38.86	1.38	35.05
		2						2.53	64.26		
		3						3.53	89.66		
		4						4.53	115.06		

Table Continued



Connector Group - M

Straight

TABLE - A											
AMPHENOL PART NUMBER DESIGNATOR			CONNECTOR SHELL SIZE	CABLE RANGE				L (MAX)		Y (MAX)	
SHELL SIZE	ENTRY SIZE	LENGTH		MIN		MAX		INCH	MM	INCH	MM
				INCH	MM	INCH	MM				
22	05	1	22	0.69	17.45	0.88	22.23	1.53	38.86	1.50	38.10
		2						2.53	64.26		
		3						3.53	89.66		
		4						4.53	115.06		
	06	1		0.81	20.62	1.00	25.40	1.53	38.86	1.63	41.40
		2						2.53	64.26		
		3						3.53	89.66		
		4						4.53	115.06		
	07	1		0.94	23.80	1.13	28.58	1.53	38.86	1.75	44.45
		2						2.53	64.26		
		3						3.53	89.66		
		4						4.53	115.06		
24	01	1	24	0.31	7.92	0.50	12.70	1.53	38.86	1.16	29.46
		2						2.53	64.26		
		3						3.53	89.66		
		4						4.53	115.06		
	02	1		0.44	11.10	0.63	15.88	1.53	38.86	1.25	31.75
		2						2.53	64.26		
		3						3.53	89.66		
		4						4.53	115.06		
	03	1		0.56	14.27	0.75	19.05	1.53	38.86	1.38	35.05
		2						2.53	64.26		
		3						3.53	89.66		
		4						4.53	115.06		
	04	1		0.69	17.45	0.88	22.23	1.53	38.86	1.50	38.10
		2						2.53	64.26		
		3						3.53	89.66		
		4						4.53	115.06		
	05	1		0.81	20.62	1.00	25.40	1.53	38.86	1.63	41.40
		2						2.53	64.26		
		3						3.53	89.66		
		4						4.53	115.06		
	06	1		0.94	23.80	1.13	28.58	1.53	38.86	1.75	44.45
		2						2.53	64.26		
		3						3.53	89.66		
		4						4.53	115.06		
	07	1		1.06	26.97	1.25	31.75	1.53	38.86	1.88	47.75
		2						2.53	64.26		
		3						3.53	89.66		
		4						4.53	115.06		



### Connector Group - M

90°, 45°



#### Amphenol Part Number

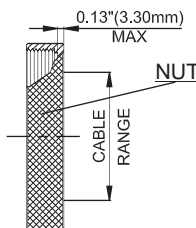

NOTE: \* For more cable entry options, contact factory

TABLE - B

AMPHENOL PART NUMBER DESIGNATOR		CONNECTOR SHELL SIZE	CABLE RANGE				A DIA. (MAX)		B (MAX)		C (MAX)		D (MAX)		E (MAX)		Y (MAX)	
SHELL SIZE	ENTRY SIZE		MIN		MAX		INCH	MM	INCH	MM	INCH	MM	INCH	MM	INCH	MM	INCH	MM
			INCH	MM	INCH	MM												
08	01	8	0.06	1.57	0.13	3.18	0.75	19.05	0.46	11.68	3.15	80.01	0.69	17.53	3.46	87.88	0.78	19.81
	02		0.13	3.18	0.25	6.35											0.97	24.64
10	01	10	0.06	1.57	0.13	3.18	0.85	21.59	0.52	13.21	3.21	81.53	0.78	19.81	3.58	90.93	0.78	19.81
	02		0.13	3.18	0.25	6.35											0.97	24.64
	03		0.25	6.35	0.38	9.53											1.06	26.92
12	01	12	0.13	3.18	0.25	6.35	1.00	25.40	0.58	14.73	3.27	83.06	0.80	20.32	3.60	91.44	0.97	24.64
	02		0.25	6.35	0.38	9.53											1.06	26.92
	03		0.31	7.92	0.50	12.70											1.16	29.46
14	01	14	0.13	3.18	0.25	6.35	1.15	29.21	0.65	16.51	3.36	85.34	0.88	22.35	3.67	93.22	0.97	24.64
	02		0.25	6.35	0.38	9.53											1.06	26.92
	03		0.31	7.92	0.50	12.70											1.16	29.46
	04		0.44	11.10	0.63	15.88											1.25	31.75

Table Continued

Connector Group - M

90°, 45°

TABLE - B

AMPHENOL PART NUMBER DESIGNATOR		CONNECTOR SHELL SIZE	CABLE RANGE				A DIA. (MAX)		B (MAX)		C (MAX)		D (MAX)		E (MAX)		Y (MAX)	
SHELL SIZE	ENTRY SIZE		MIN		MAX		INCH	MM	INCH	MM	INCH	MM	INCH	MM	INCH	MM	INCH	MM
			INCH	MM	INCH	MM												
16	01	16	0.13	3.18	0.25	6.35	1.25	31.75	0.74	18.80	3.47	88.14	0.93	23.62	3.76	95.50	0.97	24.64
	02		0.25	6.35	0.38	9.53											1.06	26.92
	03		0.31	7.92	0.50	12.70											1.16	29.46
	04		0.44	11.10	0.63	15.88											1.25	31.75
	05		0.56	14.27	0.75	19.05											1.38	35.05
18	01	18	0.25	6.35	0.38	9.53	1.40	35.56	0.93	23.62	3.66	92.96	1.01	25.65	3.93	99.82	1.06	26.92
	02		0.31	7.92	0.50	12.70											1.16	29.46
	03		0.44	11.10	0.63	15.88											1.25	31.75
	04		0.56	14.27	0.75	19.05											1.38	35.05
	05		0.69	17.45	0.88	22.23											1.50	38.10
20	01	20	0.25	6.35	0.38	9.53	1.55	39.37	0.93	23.62	3.66	92.96	1.06	26.92	3.93	99.82	1.06	26.92
	02		0.31	7.92	0.50	12.70											1.16	29.46
	03		0.44	11.10	0.63	15.88											1.25	31.75
	04		0.56	14.27	0.75	19.05											1.38	35.05
	05		0.69	17.45	0.88	22.23											1.50	38.10
	06		0.81	20.62	1.00	25.40											1.63	41.40
22	01	22	0.25	6.35	0.38	9.53	1.65	41.91	1.02	25.91	3.81	96.77	1.17	29.72	4.04	102.62	1.06	26.92
	02		0.31	7.92	0.50	12.70											1.16	29.46
	03		0.44	11.10	0.63	15.88											1.25	31.75
	04		0.56	14.27	0.75	19.05											1.38	35.05
	05		0.69	17.45	0.88	22.23											1.50	38.10
	06		0.81	20.62	1.00	25.40											1.63	41.40
	07		0.94	23.80	1.13	28.58											1.75	44.45
24	01	24	0.31	7.92	0.50	12.70	1.85	46.99	1.02	25.91	3.81	96.77	1.18	29.97	4.04	102.62	1.16	29.46
	02		0.44	11.10	0.63	15.88											1.25	31.75
	03		0.56	14.27	0.75	19.05											1.38	35.05
	04		0.69	17.45	0.88	22.23											1.50	38.10
	05		0.81	20.62	1.00	25.40											1.63	41.40
	06		0.94	23.80	1.13	28.58											1.75	44.45
	07		1.06	26.97	1.25	31.75											1.88	47.75



### Connector Group - N

### Straight

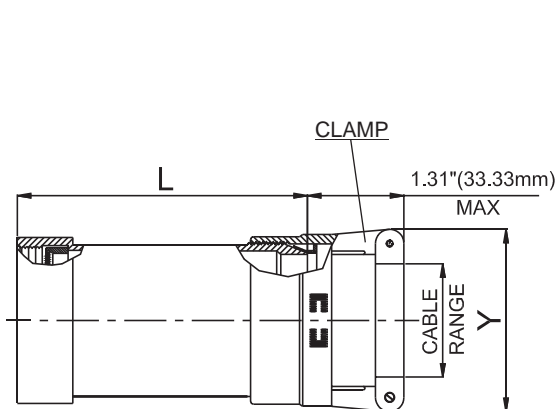

#### Amphenol Part Number

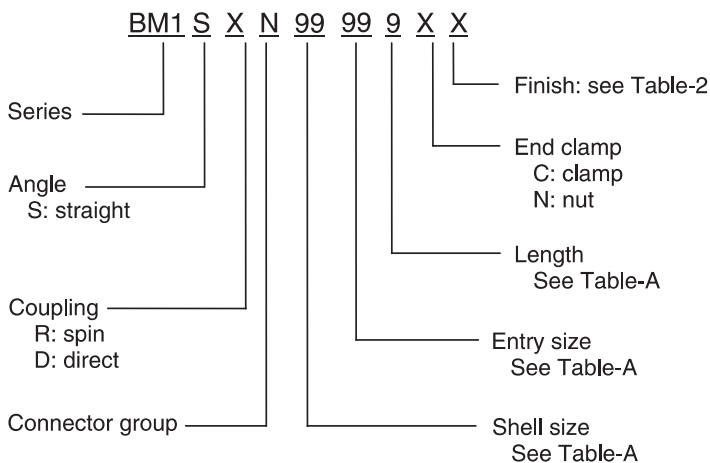

**NOTE:** \* For more cable entry and length options, contact factory

TABLE - A											
AMPHENOL PART NUMBER DESIGNATOR			CONNECTOR SHELL SIZE	CABLE RANGE				L (MAX)		Y (MAX)	
SHELL SIZE	ENTRY SIZE	LENGTH		MIN		MAX		INCH	MM	INCH	MM
				INCH	MM	INCH	MM				
08	01	1	8	0.06	1.57	0.13	3.18	1.53	38.86	0.78	19.81
		2						2.53	64.26		
	02	1		0.13	3.18	0.25	6.35	1.53	38.86	0.97	24.64
		2						2.53	64.26		
10	01	1	10	0.06	1.57	0.13	3.18	1.53	38.86	0.78	19.81
		2						2.53	64.26		
	02	1		0.13	3.18	0.25	6.35	1.53	38.86	0.97	24.64
		2						2.53	64.26		
	03	1		0.25	6.35	0.38	9.53	1.53	38.86	1.06	26.92
		2						2.53	64.26		
12	01	1	12	0.13	3.18	0.25	6.35	1.53	38.86	0.97	24.64
		2						2.53	64.26		
	02	1		0.25	6.35	0.38	9.53	1.53	38.86	1.06	26.92
		2						2.53	64.26		
	03	1		0.31	7.92	0.50	12.70	1.53	38.86	1.16	29.46
		2						2.53	64.26		
14	01	1	14	0.13	3.18	0.25	6.35	1.53	38.86	0.97	24.64
		2						2.53	64.26		
		3						3.53	89.66		

Table Continued

Connector Group - N

Straight

TABLE - A											
AMPHENOL PART NUMBER DESIGNATOR			CONNECTOR SHELL SIZE	CABLE RANGE				L (MAX)		Y (MAX)	
SHELL SIZE	ENTRY SIZE	LENGTH		MIN		MAX		INCH	MM	INCH	MM
				INCH	MM	INCH	MM				
14	02	1	14	0.25	6.35	0.38	9.53	1.53	38.86	1.06	26.92
		2						2.53	64.26		
		3						3.53	89.66		
	03	1		0.31	7.92	0.50	12.70	1.53	38.86	1.16	29.46
		2						2.53	64.26		
		3						3.53	89.66		
	04	1		0.44	11.10	0.63	15.88	1.53	38.86	1.25	31.75
		2						2.53	64.26		
		3						3.53	89.66		
16	01	1	16	0.13	3.18	0.25	6.35	1.53	38.86	0.97	24.64
		2						2.53	64.26		
		3						3.53	89.66		
	02	1		0.25	6.35	0.38	9.53	1.53	38.86	1.06	26.92
		2						2.53	64.26		
		3						3.53	89.66		
	03	1		0.31	7.92	0.50	12.70	1.53	38.86	1.16	29.46
		2						2.53	64.26		
		3						3.53	89.66		
	04	1		0.44	11.10	0.63	15.88	1.53	38.86	1.25	31.75
		2						2.53	64.26		
		3						3.53	89.66		
	05	1		0.56	14.27	0.75	19.05	1.53	38.86	1.38	35.05
		2						2.53	64.26		
		3						3.53	89.66		
18	01	1	18	0.25	6.35	0.38	9.53	1.53	38.86	1.06	26.92
		2						2.53	64.26		
		3						3.53	89.66		
	02	1		0.31	7.92	0.50	12.70	1.53	38.86	1.16	29.46
		2						2.53	64.26		
		3						3.53	89.66		
	03	1		0.44	11.10	0.63	15.88	1.53	38.86	1.25	31.75
		2						2.53	64.26		
		3						3.53	89.66		
	04	1		0.56	14.27	0.75	19.05	1.53	38.86	1.38	35.05
		2						2.53	64.26		
		3						3.53	89.66		
	05	1		0.69	17.45	0.88	22.23	1.53	38.86	1.50	38.10
		2						2.53	64.26		
		3						3.53	89.66		

Table Continued





Connector Group - N

Straight

TABLE - A											
AMPHENOL PART NUMBER DESIGNATOR			CONNECTOR SHELL SIZE	CABLE RANGE				L (MAX)		Y (MAX)	
SHELL SIZE	ENTRY SIZE	LENGTH		MIN		MAX		INCH	MM	INCH	MM
				INCH	MM	INCH	MM				
20	01	1	20	0.25	6.35	0.38	9.53	1.53	38.86	1.06	26.92
		2						2.53	64.26		
		3						3.53	89.66		
		4						4.53	115.06		
	02	1		0.31	7.92	0.50	12.70	1.53	38.86	1.16	29.46
		2						2.53	64.26		
		3						3.53	89.66		
		4						4.53	115.06		
	03	1		0.44	11.10	0.63	15.88	1.53	38.86	1.25	31.75
		2						2.53	64.26		
		3						3.53	89.66		
		4						4.53	115.06		
	04	1		0.56	14.27	0.75	19.05	1.53	38.86	1.38	35.05
		2						2.53	64.26		
		3						3.53	89.66		
		4						4.53	115.06		
	05	1		0.69	17.45	0.88	22.23	1.53	38.86	1.50	38.10
		2						2.53	64.26		
		3						3.53	89.66		
		4						4.53	115.06		
	06	1		0.81	20.62	1.00	25.40	1.53	38.86	1.63	41.40
		2						2.53	64.26		
		3						3.53	89.66		
		4						4.53	115.06		
22	01	1	22	0.25	6.35	0.38	9.53	1.53	38.86	1.06	26.92
		2						2.53	64.26		
		3						3.53	89.66		
		4						4.53	115.06		
	02	1		0.31	7.92	0.50	12.70	1.53	38.86	1.16	29.46
		2						2.53	64.26		
		3						3.53	89.66		
		4						4.53	115.06		
	03	1		0.44	11.10	0.63	15.88	1.53	38.86	1.25	31.75
		2						2.53	64.26		
		3						3.53	89.66		
		4						4.53	115.06		

Table Continued



Connector Group - N

Straight

TABLE - A											
AMPHENOL PART NUMBER DESIGNATOR			CONNECTOR SHELL SIZE	CABLE RANGE				L (MAX)		Y (MAX)	
SHELL SIZE	ENTRY SIZE	LENGTH		MIN		MAX		INCH	MM	INCH	MM
				INCH	MM	INCH	MM				
22	04	1	22	0.56	14.27	0.75	19.05	1.53	38.86	1.38	35.05
		2						2.53	64.26		
		3						3.53	89.66		
		4						4.53	115.06		
	05	1		0.69	17.45	0.88	22.23	1.53	38.86	1.50	38.10
		2						2.53	64.26		
		3						3.53	89.66		
		4						4.53	115.06		
	06	1		0.81	20.62	1.00	25.40	1.53	38.86	1.63	41.40
		2						2.53	64.26		
		3						3.53	89.66		
		4						4.53	115.06		
	07	1		0.94	23.80	1.13	28.58	1.53	38.86	1.75	44.45
		2						2.53	64.26		
		3						3.53	89.66		
		4						4.53	115.06		
24	01	1	24	0.31	7.92	0.50	12.70	1.53	38.86	1.16	29.46
		2						2.53	64.26		
		3						3.53	89.66		
		4						4.53	115.06		
	02	1		0.44	11.10	0.63	15.88	1.53	38.86	1.25	31.75
		2						2.53	64.26		
		3						3.53	89.66		
		4						4.53	115.06		
	03	1		0.56	14.27	0.75	19.05	1.53	38.86	1.38	35.05
		2						2.53	64.26		
		3						3.53	89.66		
		4						4.53	115.06		
	04	1		0.69	17.45	0.88	22.23	1.53	38.86	1.50	38.10
		2						2.53	64.26		
		3						3.53	89.66		
		4						4.53	115.06		
	05	1		0.81	20.62	1.00	25.40	1.53	38.86	1.63	41.40
		2						2.53	64.26		
		3						3.53	89.66		
		4						4.53	115.06		
	06	1		0.94	23.80	1.13	28.58	1.53	38.86	1.75	44.45
		2						2.53	64.26		
		3						3.53	89.66		
		4						4.53	115.06		
	07	1		1.06	26.97	1.25	31.75	1.53	38.86	1.88	47.75
		2						2.53	64.26		
		3						3.53	89.66		
		4						4.53	115.06		



### Connector Group - N

90°, 45°



### Amphenol Part Number



NOTE: \* For more cable entry options, contact factory

TABLE - B																		
AMPHENOL PART NUMBER DESIGNATOR		CONNECTOR SHELL SIZE	CABLE RANGE				A DIA. (MAX)		B (MAX)		C (MAX)		D (MAX)		E (MAX)		Y (MAX)	
SHELL SIZE	ENTRY SIZE		MIN		MAX		INCH	MM	INCH	MM	INCH	MM	INCH	MM	INCH	MM	INCH	MM
			INCH	MM	INCH	MM												
08	01	8	0.06	1.57	0.13	3.18	0.75	19.05	0.46	11.68	3.15	80.01	0.69	17.53	3.46	87.88	0.78	19.81
	02		0.13	3.18	0.25	6.35											0.97	24.64
10	01	10	0.06	1.57	0.13	3.18	0.85	21.59	0.52	13.21	3.21	81.53	0.78	19.81	3.58	90.93	0.78	19.81
	02		0.13	3.18	0.25	6.35											0.97	24.64
	03		0.25	6.35	0.38	9.53											1.06	26.92
12	01	12	0.13	3.18	0.25	6.35	1.00	25.40	0.58	14.73	3.27	83.06	0.80	20.32	3.60	91.44	0.97	24.64
	02		0.25	6.35	0.38	9.53											1.06	26.92
	03		0.31	7.92	0.50	12.70											1.16	29.46
14	01	14	0.13	3.18	0.25	6.35	1.15	29.21	0.65	16.51	3.36	85.34	0.88	22.35	3.67	93.22	0.97	24.64
	02		0.25	6.35	0.38	9.53											1.06	26.92
	03		0.31	7.92	0.50	12.70											1.16	29.46
	04		0.44	11.10	0.63	15.88											1.25	31.75

Table Continued

Connector Group - N

90°, 45°

TABLE - B																		
AMPHENOL PART NUMBER DESIGNATOR		CONNECTOR SHELL SIZE	CABLE RANGE				A DIA. (MAX)		B (MAX)		C (MAX)		D (MAX)		E (MAX)		Y (MAX)	
SHELL SIZE	ENTRY SIZE		MIN		MAX		INCH	MM	INCH	MM	INCH	MM	INCH	MM	INCH	MM	INCH	MM
			INCH	MM	INCH	MM												
16	01	16	0.13	3.18	0.25	6.35	1.25	31.75	0.74	18.80	3.47	88.14	0.93	23.62	3.76	95.50	0.97	24.64
	02		0.25	6.35	0.38	9.53											1.06	26.92
	03		0.31	7.92	0.50	12.70											1.16	29.46
	04		0.44	11.10	0.63	15.88											1.25	31.75
	05		0.56	14.27	0.75	19.05											1.38	35.05
18	01	18	0.25	6.35	0.38	9.53	1.40	35.56	0.93	23.62	3.66	92.96	1.01	25.65	3.93	99.82	1.06	26.92
	02		0.31	7.92	0.50	12.70											1.16	29.46
	03		0.44	11.10	0.63	15.88											1.25	31.75
	04		0.56	14.27	0.75	19.05											1.38	35.05
	05		0.69	17.45	0.88	22.23											1.50	38.10
20	01	20	0.25	6.35	0.38	9.53	1.55	39.37	0.93	23.62	3.66	92.96	1.06	26.92	3.93	99.82	1.06	26.92
	02		0.31	7.92	0.50	12.70											1.16	29.46
	03		0.44	11.10	0.63	15.88											1.25	31.75
	04		0.56	14.27	0.75	19.05											1.38	35.05
	05		0.69	17.45	0.88	22.23											1.50	38.10
	06		0.81	20.62	1.00	25.40											1.63	41.40
22	01	22	0.25	6.35	0.38	9.53	1.65	41.91	1.02	25.91	3.81	96.77	1.17	29.72	4.04	102.62	1.06	26.92
	02		0.31	7.92	0.50	12.70											1.16	29.46
	03		0.44	11.10	0.63	15.88											1.25	31.75
	04		0.56	14.27	0.75	19.05											1.38	35.05
	05		0.69	17.45	0.88	22.23											1.50	38.10
	06		0.81	20.62	1.00	25.40											1.63	41.40
	07		0.94	23.80	1.13	28.58											1.75	44.45
24	01	24	0.31	7.92	0.50	12.70	1.85	46.99	1.02	25.91	3.81	96.77	1.18	29.97	4.04	102.62	1.16	29.46
	02		0.44	11.10	0.63	15.88											1.25	31.75
	03		0.56	14.27	0.75	19.05											1.38	35.05
	04		0.69	17.45	0.88	22.23											1.50	38.10
	05		0.81	20.62	1.00	25.40											1.63	41.40
	06		0.94	23.80	1.13	28.58											1.75	44.45
	07		1.06	26.97	1.25	31.75											1.88	47.75



Компания «Океан Электроники» предлагает заключение долгосрочных отношений при поставках импортных электронных компонентов на взаимовыгодных условиях!

Наши преимущества:

- Поставка оригинальных импортных электронных компонентов напрямую с производств Америки, Европы и Азии, а так же с крупнейших складов мира;
- Широкая линейка поставок активных и пассивных импортных электронных компонентов (более 30 млн. наименований);
- Поставка сложных, дефицитных, либо снятых с производства позиций;
- Оперативные сроки поставки под заказ (от 5 рабочих дней);
- Экспресс доставка в любую точку России;
- Помощь Конструкторского Отдела и консультации квалифицированных инженеров;
- Техническая поддержка проекта, помощь в подборе аналогов, поставка прототипов;
- Поставка электронных компонентов под контролем ВП;
- Система менеджмента качества сертифицирована по Международному стандарту ISO 9001;
- При необходимости вся продукция военного и аэрокосмического назначения проходит испытания и сертификацию в лаборатории (по согласованию с заказчиком);
- Поставка специализированных компонентов военного и аэрокосмического уровня качества (Xilinx, Altera, Analog Devices, Intersil, Interpoint, Microsemi, Actel, Aeroflex, Peregrine, VPT, Syfer, Eurofarad, Texas Instruments, MS Kennedy, Miteq, Cobham, E2V, MA-COM, Hittite, Mini-Circuits, General Dynamics и др.);

Компания «Океан Электроники» является официальным дистрибьютором и эксклюзивным представителем в России одного из крупнейших производителей разъемов военного и аэрокосмического назначения «JONHON», а так же официальным дистрибьютором и эксклюзивным представителем в России производителя высокотехнологичных и надежных решений для передачи СВЧ сигналов «FORSTAR».



## JONHON

«JONHON» (основан в 1970 г.)

Разъемы специального, военного и аэрокосмического назначения:

(Применяются в военной, авиационной, аэрокосмической, морской, железнодорожной, горно- и нефтедобывающей отраслях промышленности)

«FORSTAR» (основан в 1998 г.)

ВЧ соединители, коаксиальные кабели, кабельные сборки и микроволновые компоненты:

(Применяются в телекоммуникациях гражданского и специального назначения, в средствах связи, РЛС, а так же военной, авиационной и аэрокосмической отраслях промышленности).



Телефон: 8 (812) 309-75-97 (многоканальный)

Факс: 8 (812) 320-03-32

Электронная почта: [ocean@oceanchips.ru](mailto:ocean@oceanchips.ru)

Web: <http://oceanchips.ru/>

Адрес: 198099, г. Санкт-Петербург, ул. Калинина, д. 2, корп. 4, лит. А