

### FEATURES

- Conversion gain: 12.5 dB typical**
- Image rejection: 28 dBc typical**
- Noise figure: 5 dB typical**
- Input power for 1 dB compression (P1dB): -9 dBm typical**
- Input third-order intercept (IP3): -1 dBm typical**
- Input second-order intercept (IP2): 20 dBm typical**
- 6× local oscillator (LO) leakage at RFIN: -40 dBm typical**
- 1× LO leakage at IFOUT: -50 dBm typical**
- Radio frequency (RF) return loss: 5 dB typical**
- LO return loss: 20 dB typical**
- Die size: 3.599 mm × 2.199 mm × 0.05 mm**

### APPLICATIONS

- E-band communication systems**
- High capacity wireless backhauls**
- Test and measurement**

### GENERAL DESCRIPTION

The **HMC7586** is an integrated E-band gallium arsenide (GaAs), monolithic microwave integrated circuit (MMIC) in-phase/quadrature (I/Q) downconverter chip that operates from 71 GHz to 76 GHz. The **HMC7586** provides a small signal conversion gain of 12.5 dB with 28 dBc of image rejection across the frequency band. The device uses a low noise amplifier followed by an image rejection mixer that is driven by a 6× LO multiplier.

The image rejection mixer eliminates the need for a filter following the low noise amplifier. Differential I and Q mixer outputs are provided for direct conversion applications. Alternatively, the outputs can be combined using an external 90° hybrid and two external 180° hybrids for single-sideband applications. All data includes the effect of a 1 mil gold wire wedge bond on the intermediate frequency (IF) ports.

### FUNCTIONAL BLOCK DIAGRAM

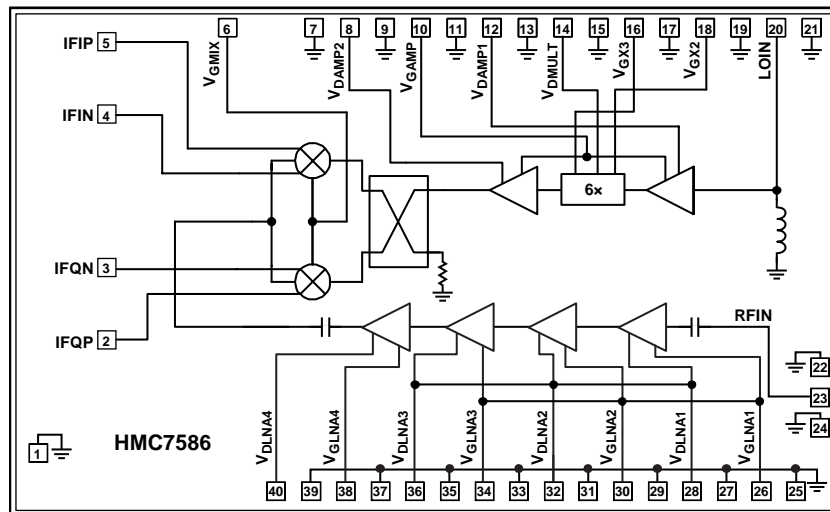

Figure 1.

## TABLE OF CONTENTS

Features .....	1	Spurious Performance With Lower Sideband Selected, IF = 500 MHz .....	44
Applications.....	1	Spurious Performance With Lower Sideband Selected, IF = 1000 MHz.....	45
General Description .....	1	Spurious Performance With Lower Sideband Selected, IF = 2000 MHz.....	46
Functional Block Diagram .....	1	Spurious Performance with Upper Sideband Selected, IF = 500 MHz.....	47
Revision History .....	2	Spurious Performance with Upper Sideband Selected, IF = 1000 MHz.....	48
Specifications.....	3	Spurious Performance with Upper Sideband Selected, IF = 2000 MHz.....	49
Absolute Maximum Ratings.....	4	Theory of Operation .....	50
Thermal Resistance .....	4	Applications Information .....	51
ESD Caution.....	4	Biasing Sequence .....	51
Pin Configuration and Function Descriptions.....	5	Image Rejection Downconversion.....	51
Interface Schematics.....	6	Zero IF Direct Conversion.....	52
Typical Performance Characteristics .....	7	Assembly Diagram .....	53
Lower Sideband Selected, IF = 1000 MHz.....	7	Mounting and Bonding Techniques for Millimeterwave GaAs MMICs.....	54
Return Loss Performance.....	12	Handling Precautions .....	54
Lower Sideband Selected, IF = 500 MHz.....	13	Mounting .....	54
Lower Sideband Selected, IF = 2000 MHz.....	18	Wire Bonding.....	54
Noise Figure Performance, Lower Sideband Selected .....	23	Outline Dimensions .....	55
Amplitude Balance Performance, Lower Sideband Selected .....	24	Ordering Guide .....	55
Phase Balance Performance, Lower Sideband Selected .....	25		
Upper Sideband Selected, IF = 500 MHz.....	26		
Upper Sideband Selected, IF = 1000 MHz.....	31		
Upper Sideband Selected, IF = 2000 MHz.....	36		
Noise Figure Performance, Upper Sideband Selected .....	41		
Amplitude Balance Performance, Upper Sideband Selected .....	42		
Phase Balance Performance, Upper Sideband Selected .....	43		

## REVISION HISTORY

3/16—Revision A: Initial Version

## SPECIFICATIONS

$T_A = 25^\circ\text{C}$ ,  $IF = 1000\text{ MHz}$ ,  $V_{\text{GMIX}} = -1\text{ V}$ ,  $V_{\text{DAMPx}} = 4\text{ V}$ ,  $V_{\text{DMULT}} = 1.5\text{ V}$ , voltage on the  $V_{\text{DLNax}}$  pins ( $V_{\text{DLNA}} = 3\text{ V}$ ,  $LO = 2\text{ dBm}$ , lower sideband selected. Measurements performed as a downconverter with external  $90^\circ$  and  $180^\circ$  hybrids at the IF ports, unless otherwise noted.

**Table 1.**

Parameter	Test Conditions/Comments	Min	Typ	Max	Unit
<b>OPERATING CONDITIONS</b>					
RF Frequency Range		71		76	GHz
LO Frequency Range		11.83		14.33	GHz
IF Frequency Range		0		10	GHz
LO Drive Range		2		8	dBm
<b>PERFORMANCE</b>					
Conversion Gain		8	12.5		dB
Image Rejection		20	28		dBc
Input Third-Order Intercept (IP3)			-1		dBm
Input Second-Order Intercept (IP2)			20		dBm
Input Power for 1 dB Compression (P1dB)	$V_{\text{DLNax}} = 4\text{ V}$		-9		dBm
6× LO Leakage at RF Input (RFIN)			-40		dBm
1× LO Leakage at IF Output (IFOUT)			-50		dBm
Amplitude Balance <sup>1</sup>			-0.4		dB
Phase Balance <sup>1</sup>			±4		Degrees
Noise Figure			5		dB
RF Return Loss			5		dB
LO Return Loss	$V_{\text{DLNax}} = 4\text{ V}$		20		dB
IF Return Loss <sup>1</sup>	$V_{\text{DLNax}} = 4\text{ V}$		25		dB
<b>POWER SUPPLY</b>					
Supply Current					
$I_{\text{DAMP}}^2$			175		mA
$I_{\text{DMULT}}^3$	Under LO drive		80		mA
$I_{\text{DLNA}}^4$			50		mA

<sup>1</sup> Measurements performed without external hybrids at the IF ports.

<sup>2</sup> Adjust  $V_{\text{GAMP}}$  between -2 V and 0 V to achieve the total quiescent current,  $I_{\text{DAMP}} = I_{\text{DAMP1}} + I_{\text{DAMP2}} = 175\text{ mA}$ .

<sup>3</sup> Adjust  $V_{\text{GX2}}$  and  $V_{\text{GX3}}$  between -2 V and 0 V to achieve the total quiescent current,  $I_{\text{DMULT}} = 1\text{ mA}$  to 2 mA. See the Applications Information section for more information.

<sup>4</sup> Adjust  $V_{\text{GLNax}}$  between -2 V and 0 V to achieve the total quiescent current,  $I_{\text{DLNA1}} + I_{\text{DLNA2}} + I_{\text{DLNA3}} + I_{\text{DLNA4}} = 50\text{ mA}$ .

## ABSOLUTE MAXIMUM RATINGS

Table 2.

Parameter	Rating
Drain Bias Voltage	
$V_{DAMP1}, V_{DAMP2}$	4.5 V
$V_{DMULT}$	3 V
$V_{DLNA1}, V_{DLNA2}, V_{DLNA3}, V_{DLNA4}$	4.5 V
Gate Bias Voltage	
$V_{GAMP}$	-3 V to 0 V
$V_{GX2}, V_{GX3}$	-3 V to 0 V
$V_{GLNA1}, V_{GLNA2}, V_{GLNA3}, V_{GLNA4}$	-3 V to 0 V
$V_{GMIX}$	-3 V to 0 V
LO Input Power	10 dBm
Maximum Junction Temperature (to Maintain 1 Million Hours Mean Time to Failure (MTTF))	175°C
Storage Temperature Range	-65°C to +150°C
Operating Temperature Range	-55°C to +85°C
ESD Sensitivity, Human Body Model (HBM)	100 V (Class 0)

Stresses at or above those listed under Absolute Maximum Ratings may cause permanent damage to the product. This is a stress rating only; functional operation of the product at these or any other conditions above those indicated in the operational section of this specification is not implied. Operation beyond the maximum operating conditions for extended periods may affect product reliability.

## THERMAL RESISTANCE

Table 3. Thermal Resistance

Package Type	$\theta_{JC}^1$	Unit
40-Pad Bare Die [CHIP]	61.7	°C/W

<sup>1</sup> Based on ABLEBOND® 84-1LMIT as die attach epoxy with a thermal conductivity of 3.6 W/mK.

## ESD CAUTION



**ESD (electrostatic discharge) sensitive device.** Charged devices and circuit boards can discharge without detection. Although this product features patented or proprietary protection circuitry, damage may occur on devices subjected to high energy ESD. Therefore, proper ESD precautions should be taken to avoid performance degradation or loss of functionality.

### PIN CONFIGURATION AND FUNCTION DESCRIPTIONS

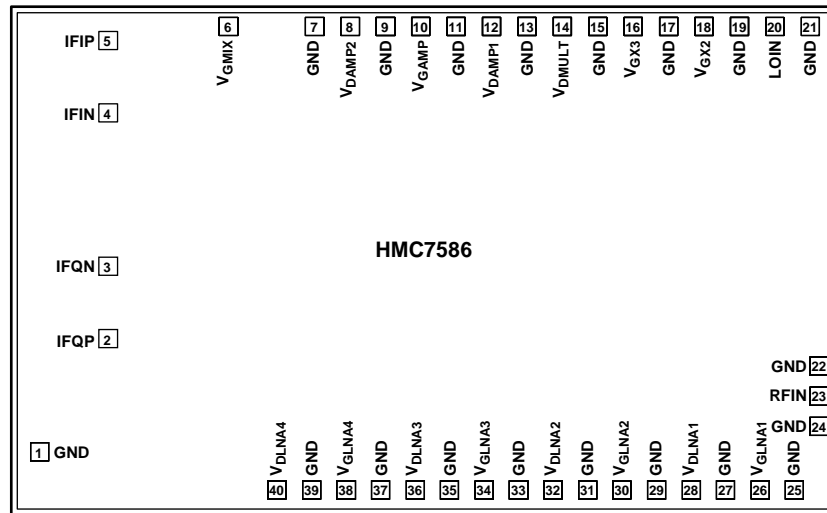

Figure 2. Pad Configuration

Table 4. Pad Function Descriptions

Pad No.	Mnemonic	Description
1, 7, 9, 11, 13, 15, 17, 19, 21, 22, 24, 25, 27, 29, 31, 33, 35, 37, 39	GND	Ground Connect. See Figure 3.
2, 3	IFQP, IFQN	Positive and Negative IF Q Outputs. These pads are dc-coupled. When operation to dc is not required, block these pads externally using a series capacitor with a value chosen to pass the necessary frequency range. For operation to dc, these pads must not source or sink more than 3 mA of current or die malfunction and die failure may result (see Figure 4).
4, 5	IFIN, IFIP	Negative and Positive IF I Outputs. These pads are dc-coupled. When operation to dc is not required, block these pads externally using a series capacitor with a value chosen to pass the necessary frequency range. For operation to dc, these pads must not source or sink more than 3 mA of current or die malfunction and die failure may result (see Figure 4).
6	V <sub>GMIX</sub>	Gate Voltage for the FET Mixer. See Figure 5. Refer to the typical application circuit for required external components (see Figure 211).
8, 12	V <sub>DAMP2</sub> , V <sub>DAMP1</sub>	Power Supply Voltage for the First and the Second Stage LO Amplifier. See Figure 5. Refer to the typical application circuit for required external components (see Figure 211).
10	V <sub>GAMP</sub>	Gate Voltage for the First and the Second Stage LO Amplifier. See Figure 5. Refer to the typical application circuit for required external components (see Figure 211).
14	V <sub>DMULT</sub>	Power Supply Voltage for the LO Multiplier. See Figure 5. Refer to the typical application circuit for required external components (see Figure 211).
16, 18	V <sub>GX3</sub> , V <sub>GX2</sub>	Gate Voltage for the LO Multiplier. See Figure 5. Refer to the typical application circuit for required external components (see Figure 211).
20	LOIN	Local Oscillator Input. This pad is dc-coupled and matched to 50 Ω (see Figure 6).
23	RFIN	RF Input. This pad is ac-coupled and matched to 50 Ω (see Figure 7).
26, 30, 34, 38	V <sub>GLNA1</sub> , V <sub>GLNA2</sub> , V <sub>GLNA3</sub> , V <sub>GLNA4</sub>	Gate Voltage for the Low Noise Amplifier. See Figure 8. Refer to the typical application circuit for required external components (see Figure 211).
28, 32, 36, 40	V <sub>DLNA1</sub> , V <sub>DLNA2</sub> , V <sub>DLNA3</sub> , V <sub>DLNA4</sub>	Power Supply Voltage for the Low Noise Amplifier. See Figure 8. Refer to the typical application circuit for required external components (see Figure 211).
Die Bottom	GND	Ground. Die bottom must be connected to RF/dc ground (see Figure 3).

INTERFACE SCHEMATICS



Figure 3. GND Interface

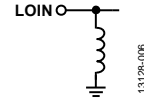

Figure 6. LOIN Interface

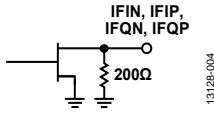

Figure 4. IFIP, IFIN, IFQN, IFQP, and  $V_{GMIX}$  Interface

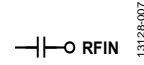

Figure 7. RFIN Interface

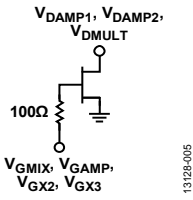

Figure 5.  $V_{DAMP1}$ ,  $V_{DAMP2}$ ,  $V_{DMULT}$ ,  $V_{GAMP}$ ,  $V_{GMIX}$ ,  $V_{GX2}$ , and  $V_{GX3}$  Interface

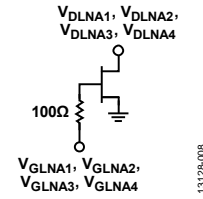

Figure 8.  $V_{DLNA1}$ ,  $V_{DLNA2}$ ,  $V_{DLNA3}$ ,  $V_{DLNA4}$ ,  $V_{GLNA1}$ ,  $V_{GLNA2}$ ,  $V_{GLNA3}$ , and  $V_{GLNA4}$  Interface

# TYPICAL PERFORMANCE CHARACTERISTICS

## LOWER SIDEBAND SELECTED, IF = 1000 MHz

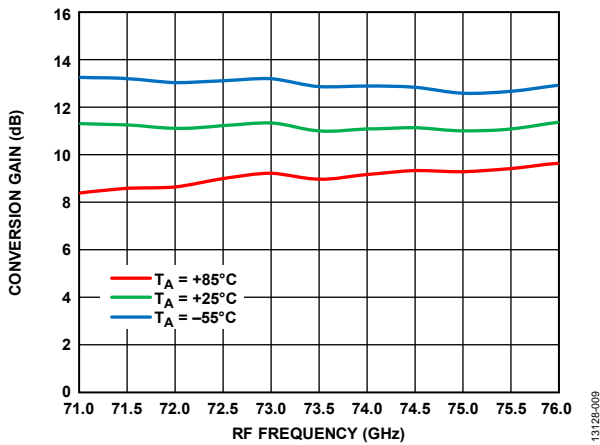

Figure 9. Conversion Gain vs. RF Frequency at Various Temperatures,  $RFIN = -20\text{ dBm}$ ,  $LO = 2\text{ dBm}$ ,  $IF = 1000\text{ MHz}$ ,  $V_{DLNA} = 4\text{ V}$

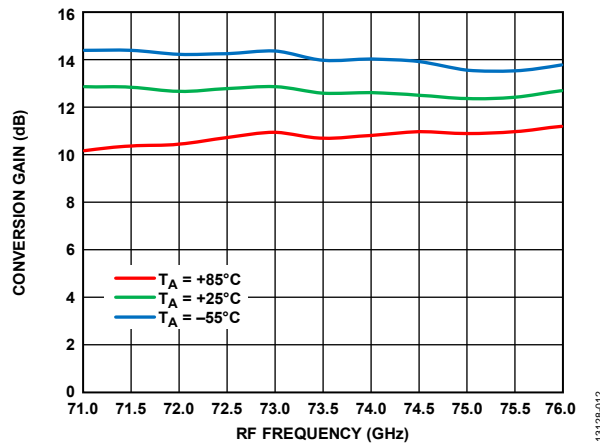

Figure 12. Conversion Gain vs. RF Frequency at Various Temperatures,  $RFIN = -20\text{ dBm}$ ,  $LO = 2\text{ dBm}$ ,  $IF = 1000\text{ MHz}$ ,  $V_{DLNA} = 3\text{ V}$

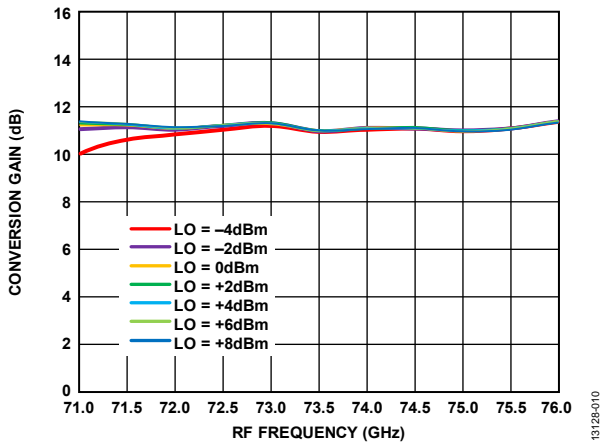

Figure 10. Conversion Gain vs. RF Frequency at Various LO Powers,  $RFIN = -20\text{ dBm}$ ,  $IF = 1000\text{ MHz}$ ,  $V_{DLNA} = 4\text{ V}$

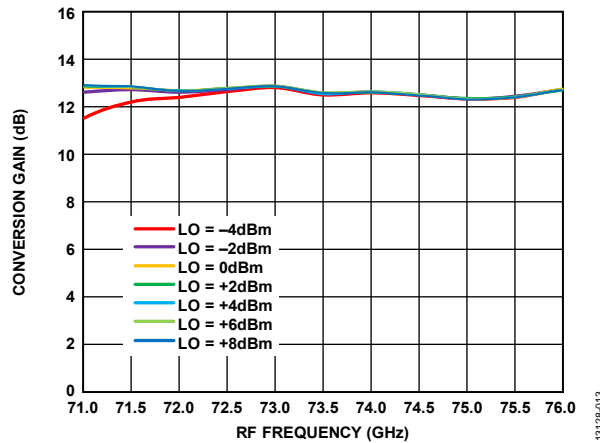

Figure 13. Conversion Gain vs. RF Frequency at Various LO Powers,  $RFIN = -20\text{ dBm}$ ,  $IF = 1000\text{ MHz}$ ,  $V_{DLNA} = 3\text{ V}$

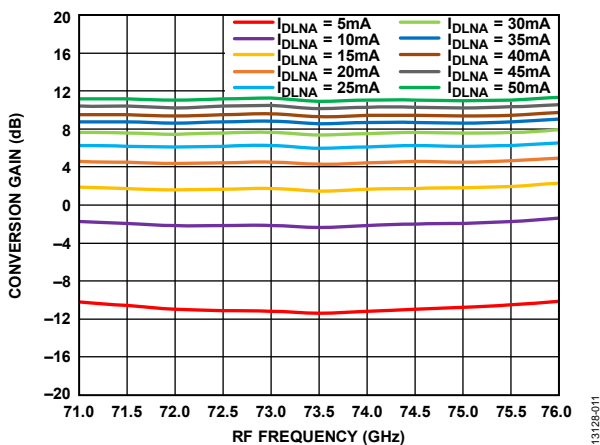

Figure 11. Conversion Gain vs. RF Frequency at Various  $I_{DLNA}$  Values,  $RFIN = -20\text{ dBm}$ ,  $IF = 1000\text{ MHz}$ ,  $V_{DLNA} = 4\text{ V}$

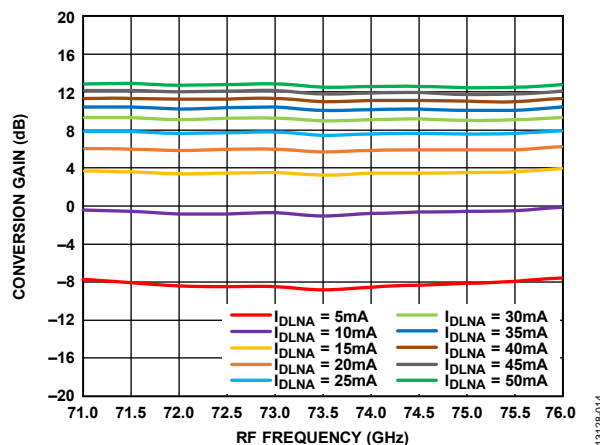

Figure 14. Conversion Gain vs. RF Frequency at Various  $I_{DLNA}$  Values,  $RFIN = -20\text{ dBm}$ ,  $IF = 1000\text{ MHz}$ ,  $V_{DLNA} = 3\text{ V}$

13128-009

13128-012

13128-010

13128-013

13128-011

13128-014

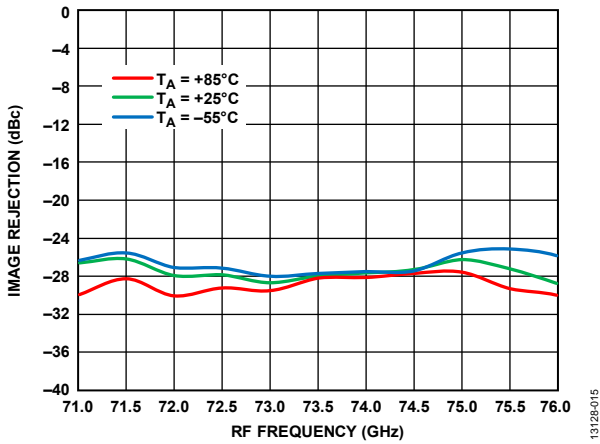

Figure 15. Image Rejection vs. RF Frequency at Various Temperatures,  $R_{FIN} = -20$  dBm,  $L_O = 2$  dBm,  $I_F = 1000$  MHz,  $V_{DLNA} = 4$  V

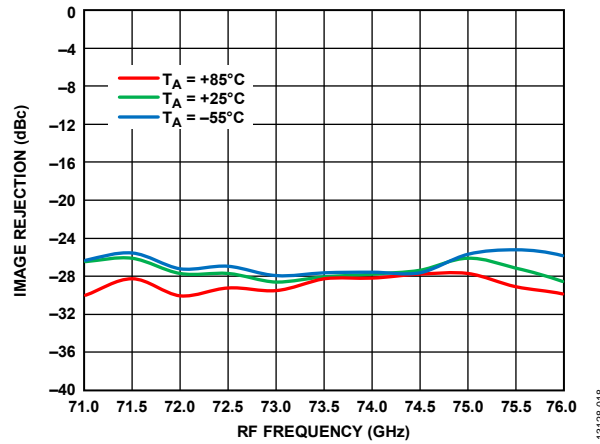

Figure 18. Image Rejection vs. RF Frequency at Various Temperatures,  $R_{FIN} = -20$  dBm,  $L_O = 2$  dBm,  $I_F = 1000$  MHz,  $V_{DLNA} = 3$  V

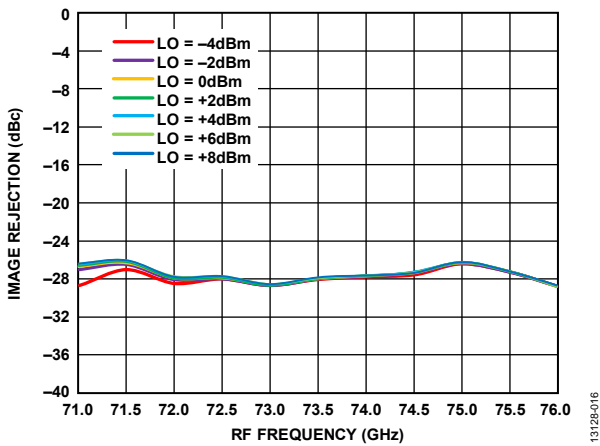

Figure 16. Image Rejection vs. RF Frequency at Various LO Powers,  $R_{FIN} = -20$  dBm,  $I_F = 1000$  MHz,  $V_{DLNA} = 4$  V

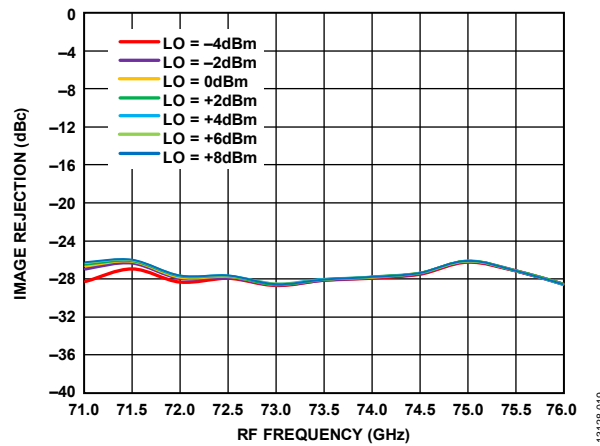

Figure 19. Image Rejection vs. RF Frequency at Various LO Powers,  $R_{FIN} = -20$  dBm,  $I_F = 1000$  MHz,  $V_{DLNA} = 3$  V

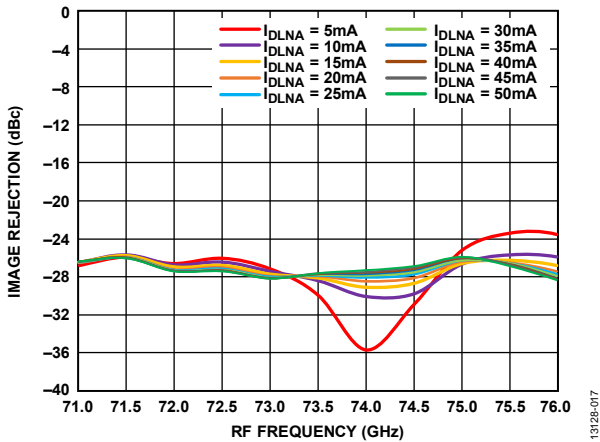

Figure 17. Image Rejection vs. RF Frequency at Various  $I_{DLNA}$  Values,  $R_{FIN} = -20$  dBm,  $L_O = 2$  dBm,  $I_F = 1000$  MHz,  $V_{DLNA} = 4$  V

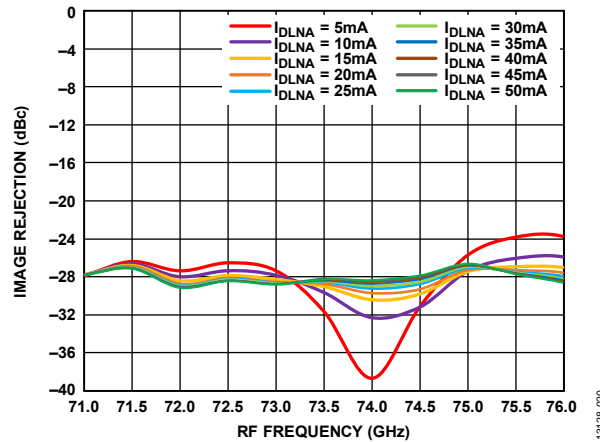

Figure 20. Image Rejection vs. RF Frequency at Various  $I_{DLNA}$  Values,  $R_{FIN} = -20$  dBm,  $L_O = 2$  dBm,  $I_F = 1000$  MHz,  $V_{DLNA} = 3$  V



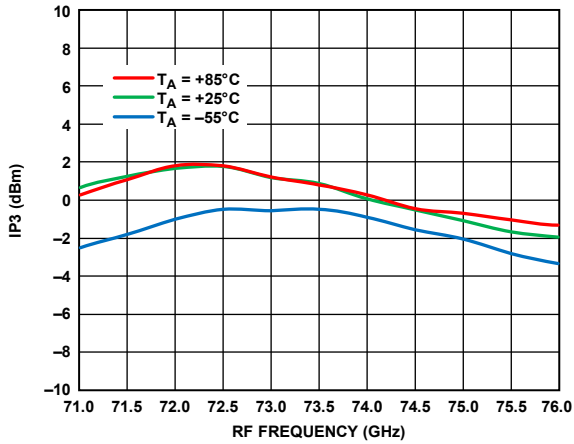

Figure 21. Input IP3 vs. RF Frequency at Various Temperatures,  $R_{FIN} = -20$  dBm,  $LO = 2$  dBm,  $IF = 1000$  MHz,  $V_{DLNA} = 4$  V

13128-021

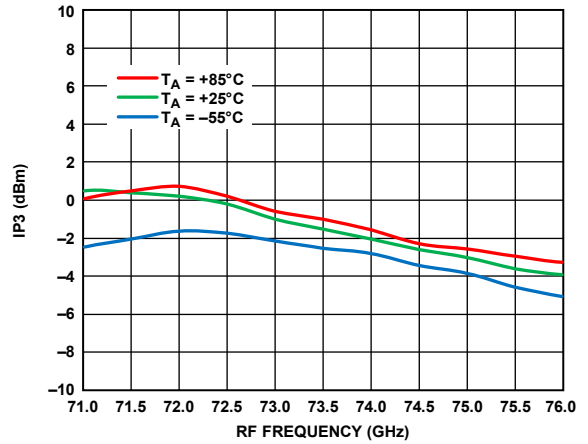

Figure 24. Input IP3 vs. RF Frequency at Various Temperatures,  $R_{FIN} = -20$  dBm,  $LO = 2$  dBm,  $IF = 1000$  MHz,  $V_{DLNA} = 3$  V

13128-024

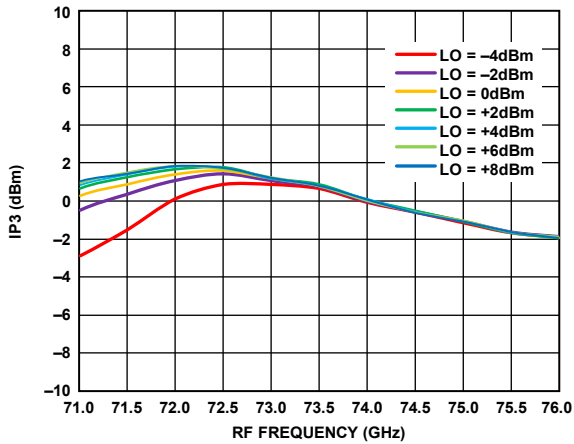

Figure 22. Input IP3 vs. RF Frequency at Various LO Powers,  $R_{FIN} = -20$  dBm,  $IF = 1000$  MHz,  $V_{DLNA} = 4$  V

13128-022

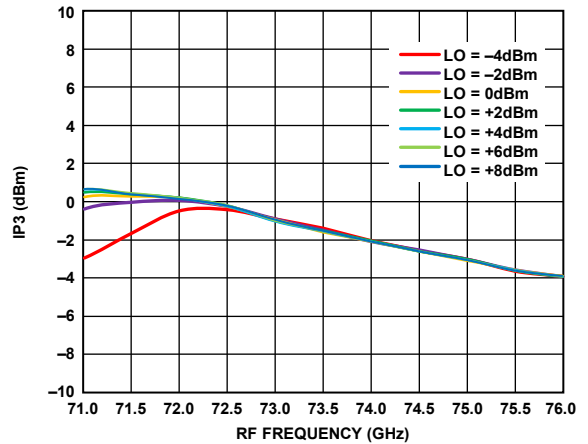

Figure 25. Input IP3 vs. RF Frequency at Various LO Powers,  $R_{FIN} = -20$  dBm,  $IF = 1000$  MHz,  $V_{DLNA} = 3$  V

13128-025

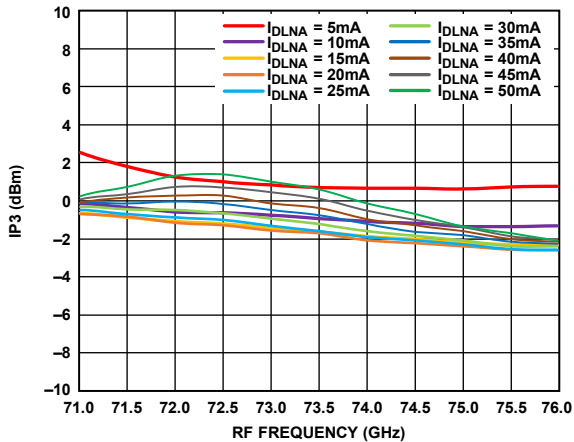

Figure 23. Input IP3 vs. RF Frequency at Various  $I_{DLNA}$  Values,  $R_{FIN} = -20$  dBm,  $LO = 2$  dBm,  $IF = 1000$  MHz,  $V_{DLNA} = 4$  V

13128-023

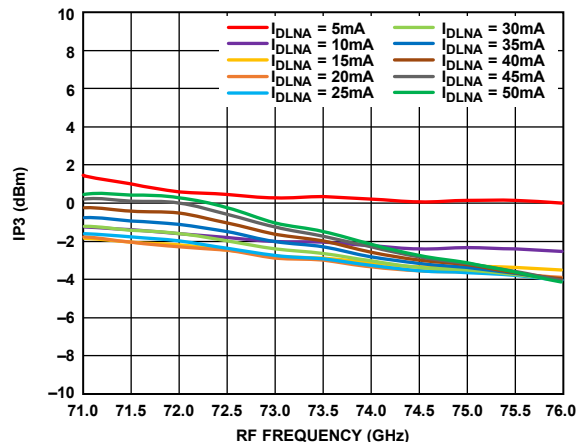
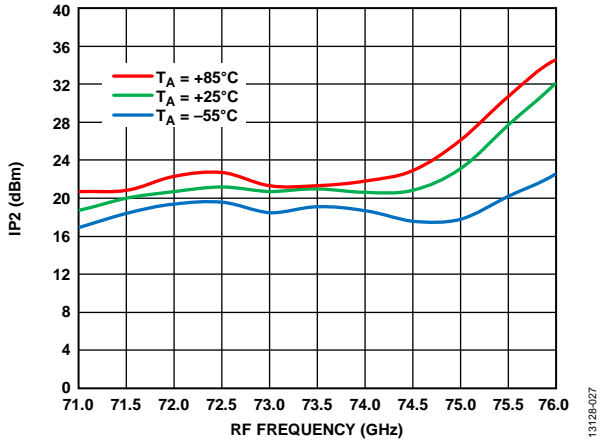

Figure 26. Input IP3 vs. RF Frequency at Various  $I_{DLNA}$  Values,  $R_{FIN} = -20$  dBm,  $LO = 2$  dBm,  $IF = 1000$  MHz,  $V_{DLNA} = 3$  V

13128-026



13128-027

Figure 27. Input IP2 vs. RF Frequency at Various Temperatures,  $R_{FIN} = -20$  dBm, LO = 2 dBm, IF = 1000 MHz,  $V_{DLNA} = 4$  V

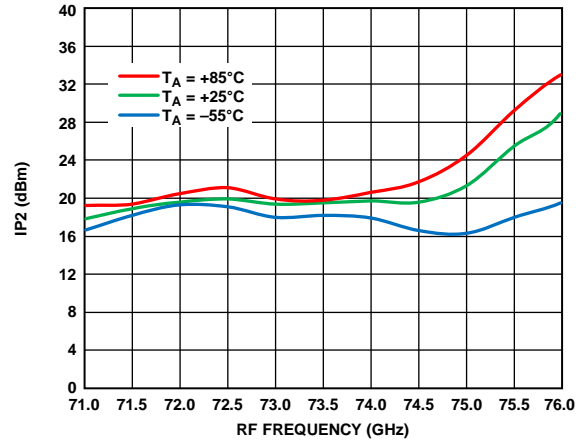

13128-030

Figure 30. Input IP2 vs. RF Frequency at Various Temperatures,  $R_{FIN} = -20$  dBm, LO = 2 dBm, IF = 1000 MHz,  $V_{DLNA} = 3$  V

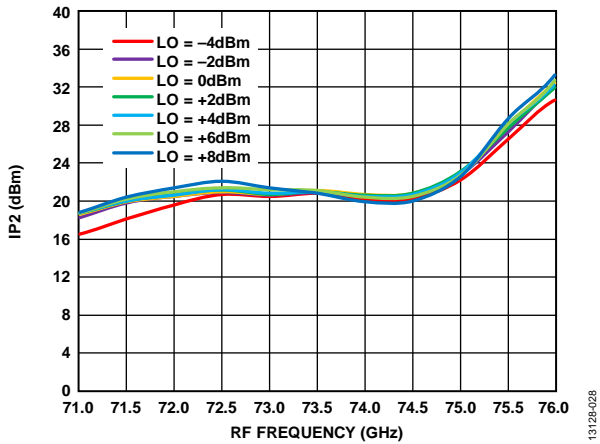

13128-028

Figure 28. Input IP2 vs. RF Frequency at Various LO Powers,  $R_{FIN} = -20$  dBm, IF = 1000 MHz,  $V_{DLNA} = 4$  V

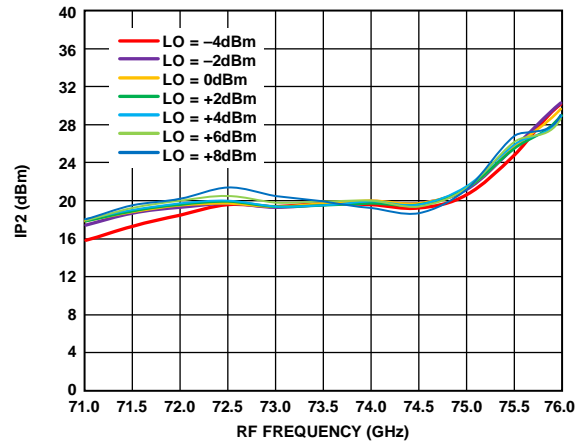

13128-031

Figure 31. Input IP2 vs. RF Frequency at Various LO Powers,  $R_{FIN} = -20$  dBm, IF = 1000 MHz,  $V_{DLNA} = 3$  V

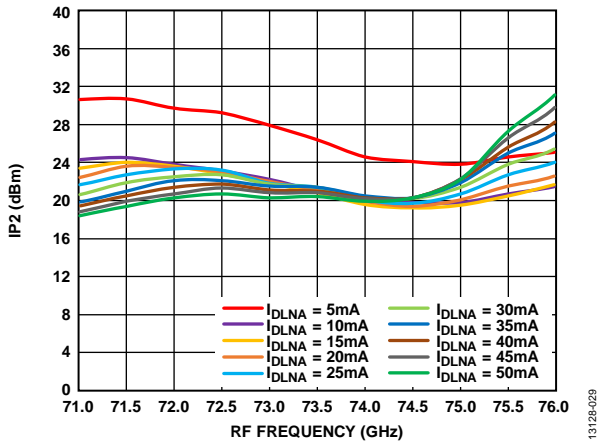

13128-029

Figure 29. Input IP2 vs. RF Frequency at Various  $I_{DLNA}$  Values,  $R_{FIN} = -20$  dBm, LO = 2 dBm, IF = 1000 MHz,  $V_{DLNA} = 4$  V

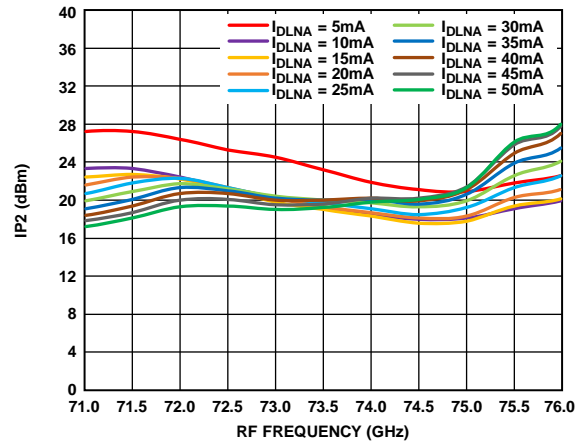

13128-032

Figure 32. Input IP2 vs. RF Frequency at Various  $I_{DLNA}$  Values,  $R_{FIN} = -20$  dBm, LO = 2 dBm, IF = 1000 MHz,  $V_{DLNA} = 3$  V

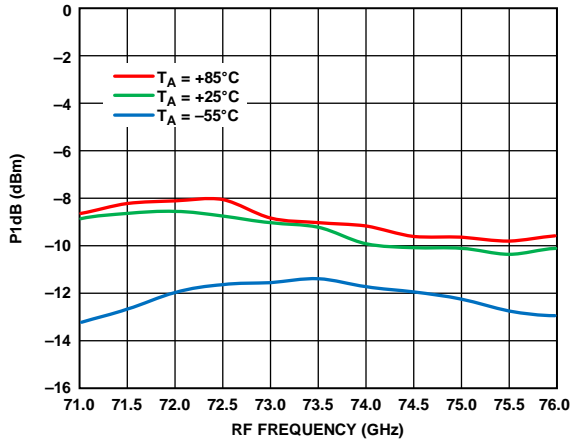

Figure 33. Input P1dB vs. RF Frequency at Various Temperatures, LO = 2 dBm, IF = 1000 MHz, V<sub>DLNA</sub> = 4 V

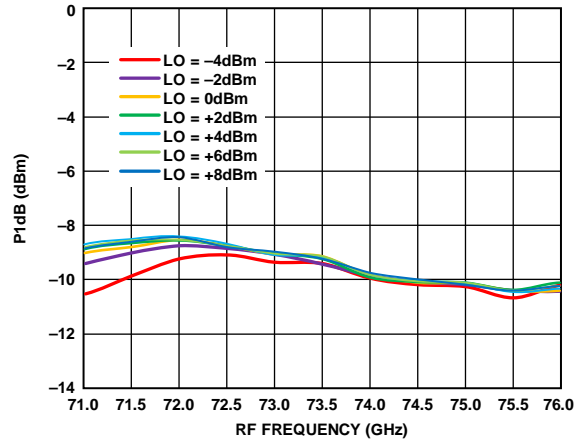

Figure 36. Input P1dB vs. RF Frequency at Various LO Powers, IF = 1000 MHz, V<sub>DLNA</sub> = 4 V

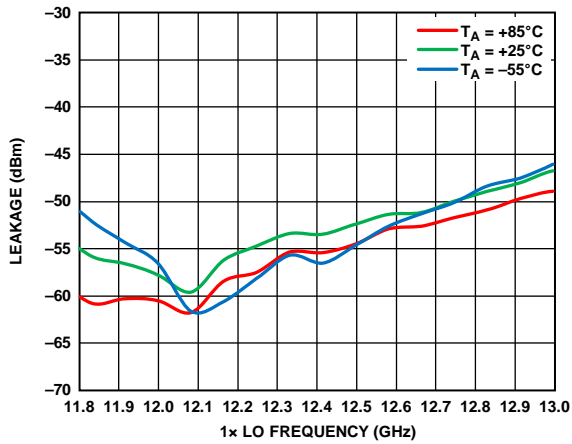

Figure 34. LO Leakage at IFOUT vs. 1x LO Frequency at Various Temperatures, LO = 2 dBm, V<sub>DLNA</sub> = 3 V

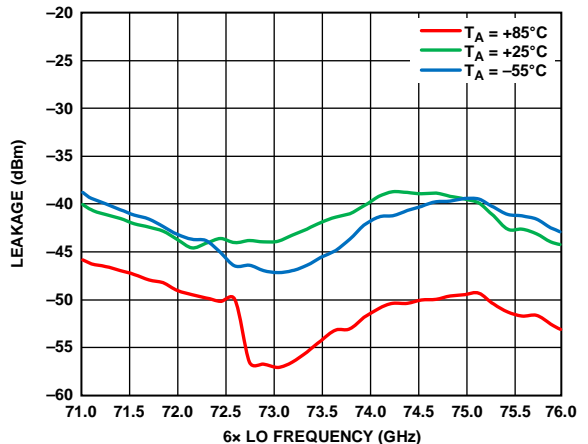

Figure 37. 6x LO Leakage at RFIN vs. 6x LO Frequency at Various Temperatures, LO = 2 dBm, V<sub>DLNA</sub> = 3 V

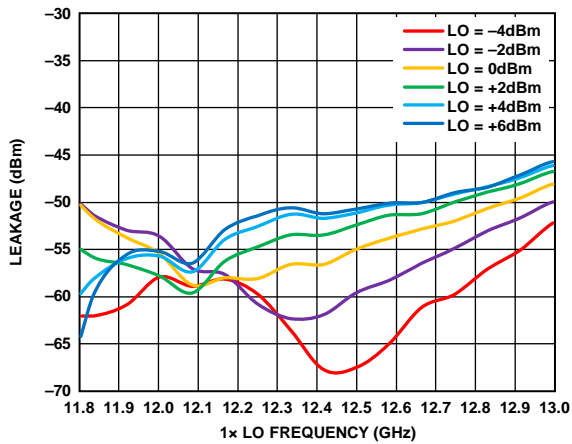

Figure 35. LO Leakage at IFOUT vs. 1x LO Frequency at Various LO Powers, V<sub>DLNA</sub> = 3 V

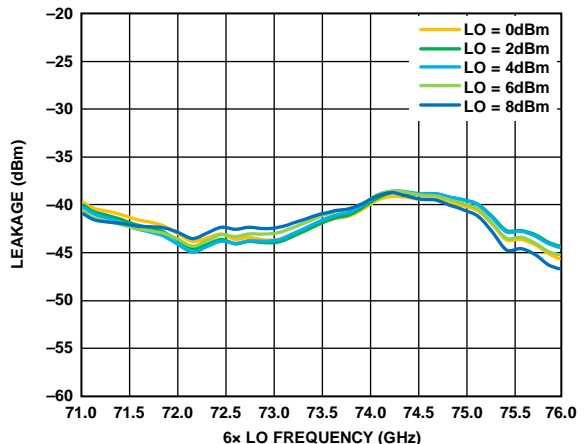

Figure 38. 6x LO Leakage at RFIN vs. 6x LO Frequency at Various LO Powers, V<sub>DLNA</sub> = 3 V

RETURN LOSS PERFORMANCE

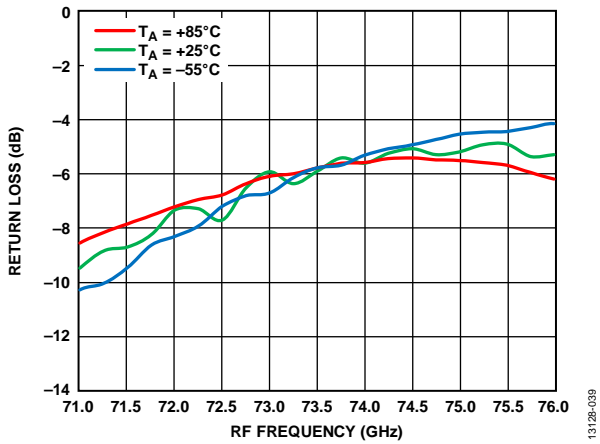

Figure 39. RF Return Loss vs. RF Frequency at Various Temperatures, LO = 2 dBm, LO = 12 GHz, V<sub>DLNA</sub> = 4 V

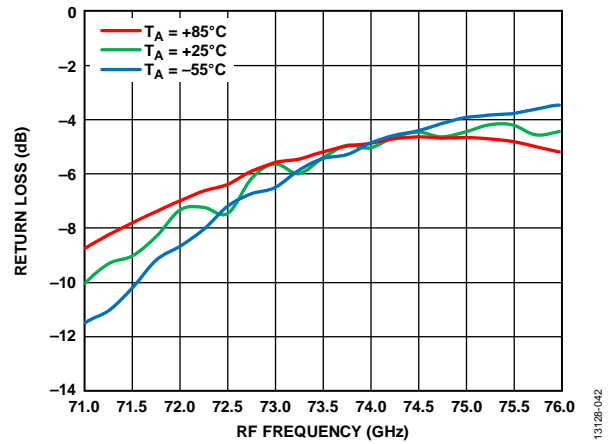

Figure 42. RF Return Loss vs. RF Frequency at Various Temperatures, LO = 2 dBm, LO = 12 GHz, V<sub>DLNA</sub> = 3 V

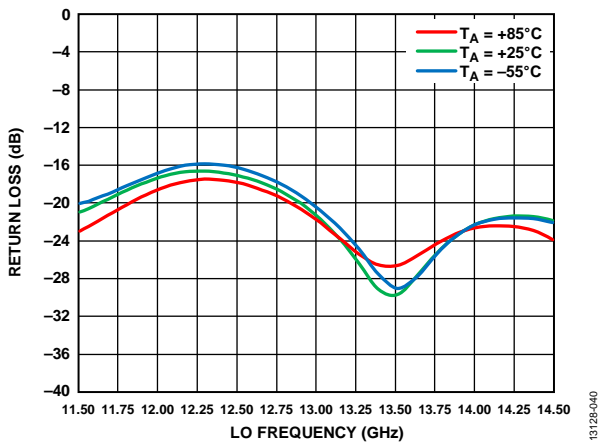

Figure 40. LO Return Loss vs. LO Frequency at Various Temperatures, LO = 2 dBm, V<sub>DLNA</sub> = 4 V

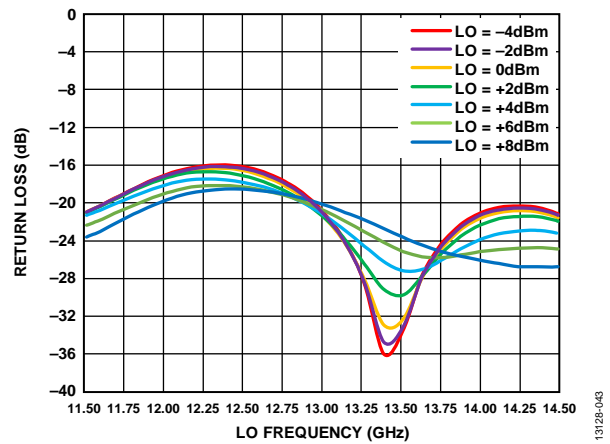

Figure 43. LO Return Loss vs. LO Frequency at Various LO Powers, V<sub>DLNA</sub> = 4 V

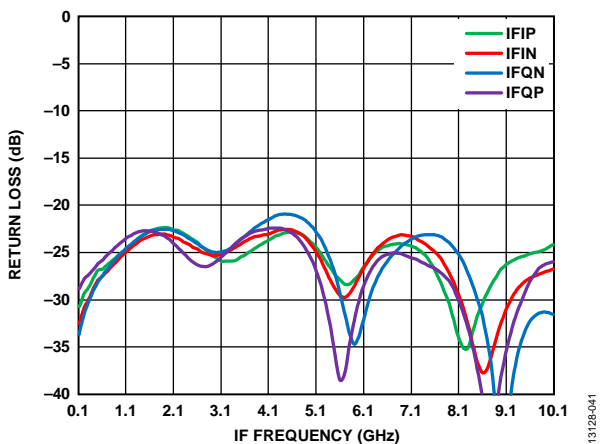

Figure 41. IF Return Loss vs. IF Frequency, LO = 2 dBm, LO = 12 GHz, V<sub>DLNA</sub> = 4 V

LOWER SIDEBAND SELECTED, IF = 500 MHz

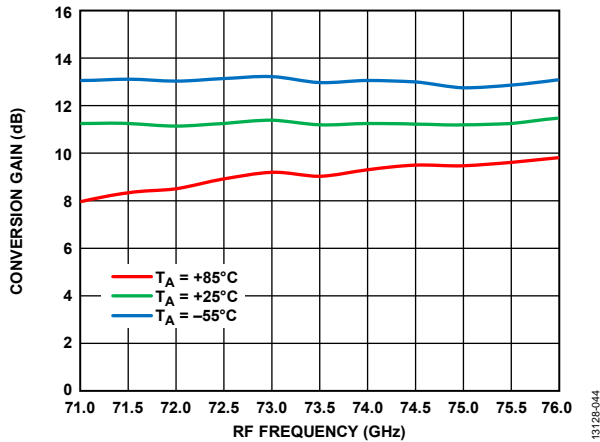

Figure 44. Conversion Gain vs. RF Frequency at Various Temperatures,  $R_{FIN} = -20$  dBm, LO = 2 dBm, IF = 500 MHz,  $V_{DLNA} = 4$  V

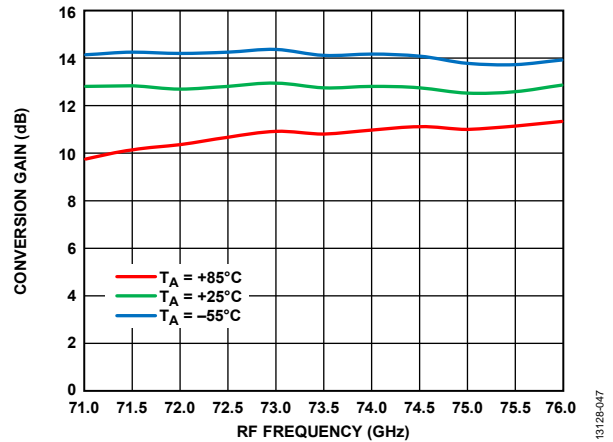

Figure 47. Conversion Gain vs. RF Frequency at Various Temperatures,  $R_{FIN} = -20$  dBm, LO = 2 dBm, IF = 500 MHz,  $V_{DLNA} = 3$  V

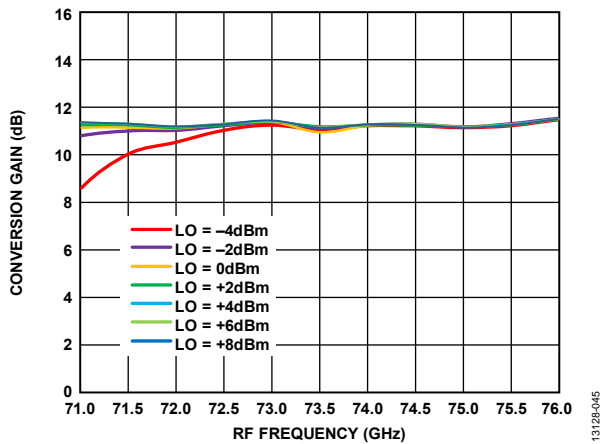

Figure 45. Conversion Gain vs. RF Frequency at Various LO Powers,  $R_{FIN} = -20$  dBm, IF = 500 MHz,  $V_{DLNA} = 4$  V

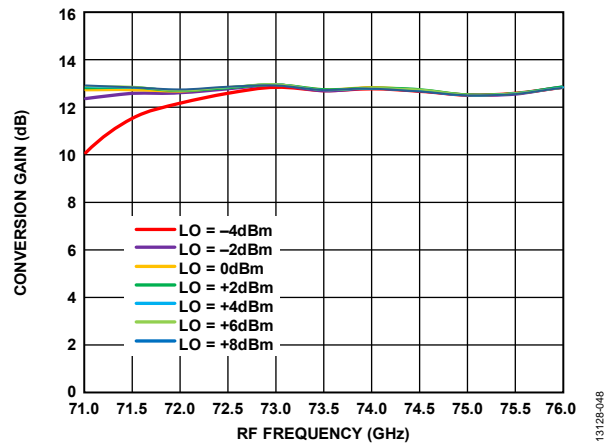

Figure 48. Conversion Gain vs. RF Frequency at Various LO Powers,  $R_{FIN} = -20$  dBm, IF = 500 MHz,  $V_{DLNA} = 3$  V

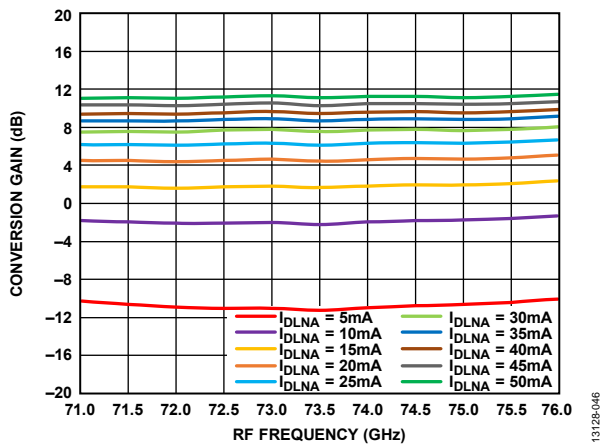

Figure 46. Conversion Gain vs. RF Frequency at Various  $I_{DLNA}$  Values,  $R_{FIN} = -20$  dBm, IF = 500 MHz,  $V_{DLNA} = 4$  V

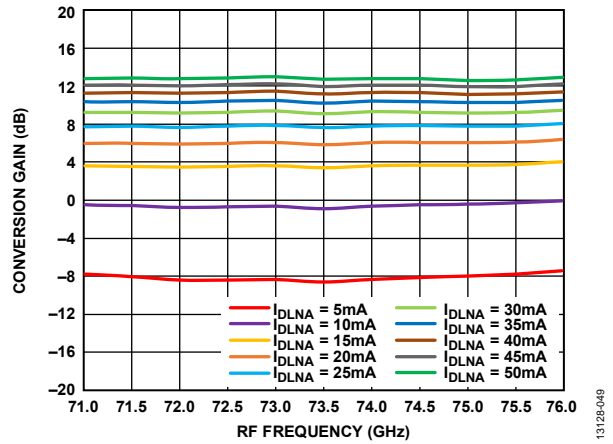
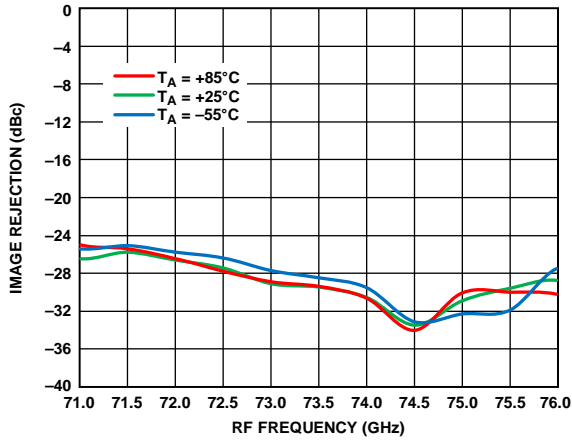
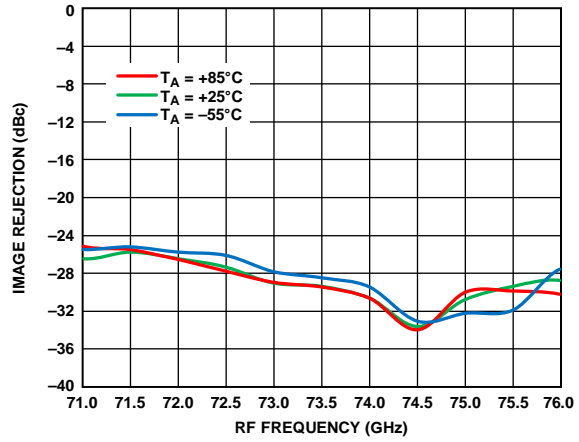

Figure 49. Conversion Gain vs. RF Frequency at Various  $I_{DLNA}$  Values,  $R_{FIN} = -20$  dBm, IF = 500 MHz,  $V_{DLNA} = 3$  V



13128-050

Figure 50. Image Rejection vs. RF Frequency at Various Temperatures,  $R_{FIN} = -20$  dBm,  $LO = 2$  dBm,  $IF = 500$  MHz,  $V_{DLNA} = 4$  V



13128-053

Figure 53. Image Rejection vs. RF Frequency at Various Temperatures,  $R_{FIN} = -20$  dBm,  $LO = 2$  dBm,  $IF = 500$  MHz,  $V_{DLNA} = 3$  V

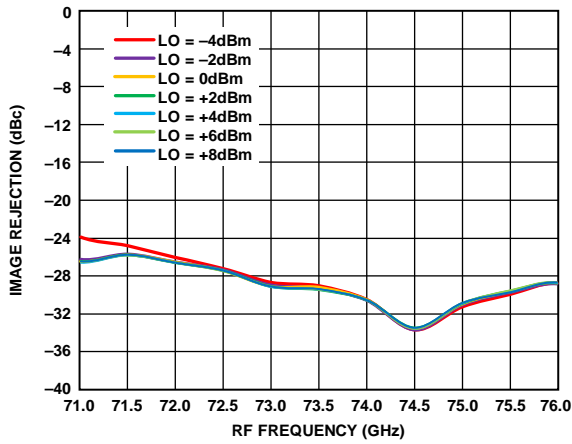

13128-051

Figure 51. Image Rejection vs. RF Frequency at Various LO Powers,  $R_{FIN} = -20$  dBm,  $IF = 500$  MHz,  $V_{DLNA} = 4$  V

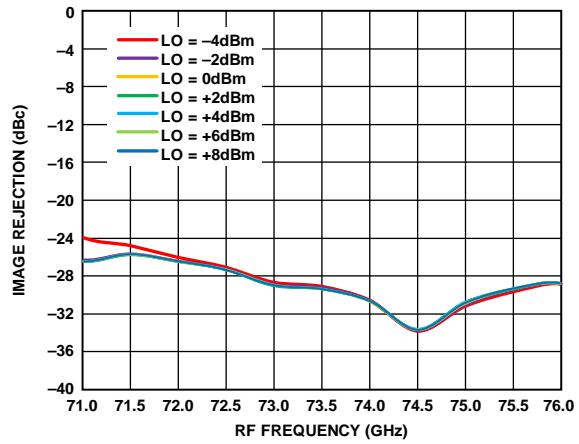

13128-054

Figure 54. Image Rejection vs. RF Frequency at Various LO Powers,  $R_{FIN} = -20$  dBm,  $IF = 500$  MHz,  $V_{DLNA} = 3$  V

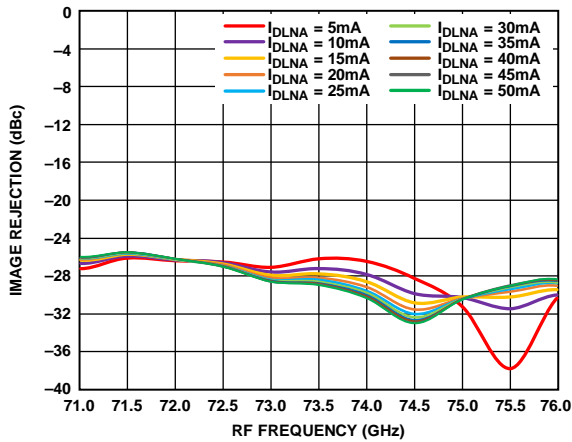

13128-052

Figure 52. Image Rejection vs. RF Frequency at Various  $I_{DLNA}$  Values,  $R_{FIN} = -20$  dBm,  $LO = 2$  dBm,  $IF = 500$  MHz,  $V_{DLNA} = 4$  V

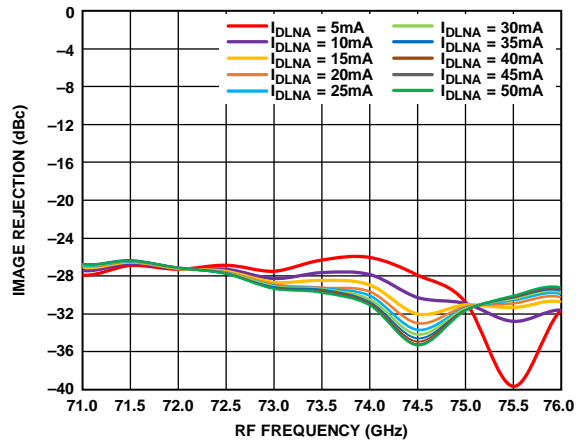

13128-055

Figure 55. Image Rejection vs. RF Frequency at Various  $I_{DLNA}$  Values,  $R_{FIN} = -20$  dBm,  $LO = 2$  dBm,  $IF = 500$  MHz,  $V_{DLNA} = 3$  V

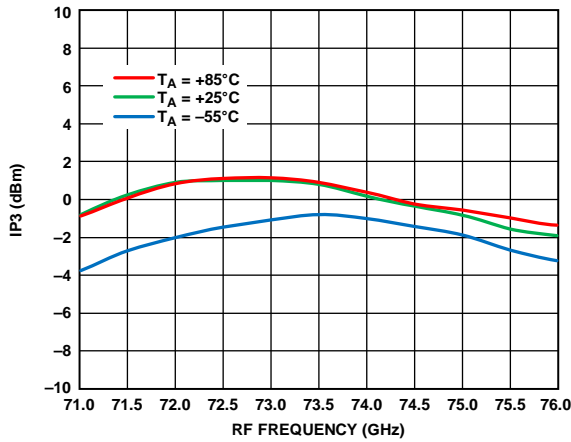

Figure 56. Input IP3 vs. RF Frequency at Various Temperatures,  $R_{FIN} = -20$  dBm,  $LO = 2$  dBm,  $IF = 500$  MHz,  $V_{DLNA} = 4$  V

13128-056

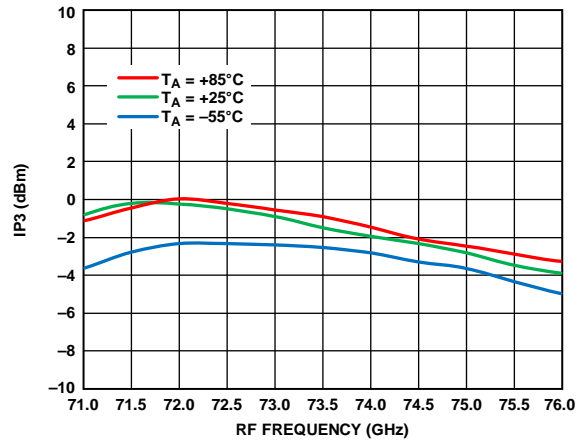

Figure 59. Input IP3 vs. RF Frequency at Various Temperatures,  $R_{FIN} = -20$  dBm,  $LO = 2$  dBm,  $IF = 500$  MHz,  $V_{DLNA} = 3$  V

13128-059

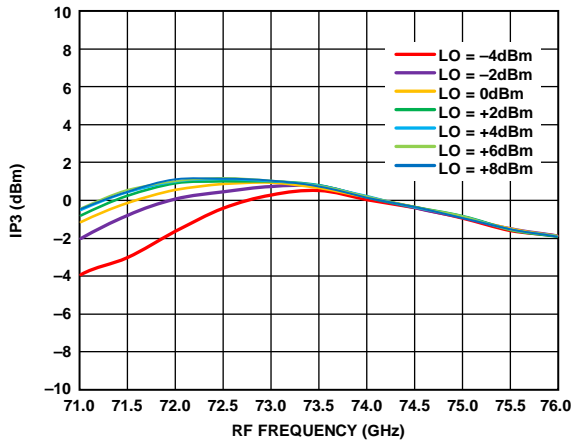

Figure 57. Input IP3 vs. RF Frequency at Various LO Powers,  $R_{FIN} = -20$  dBm,  $IF = 500$  MHz,  $V_{DLNA} = 4$  V

13128-057

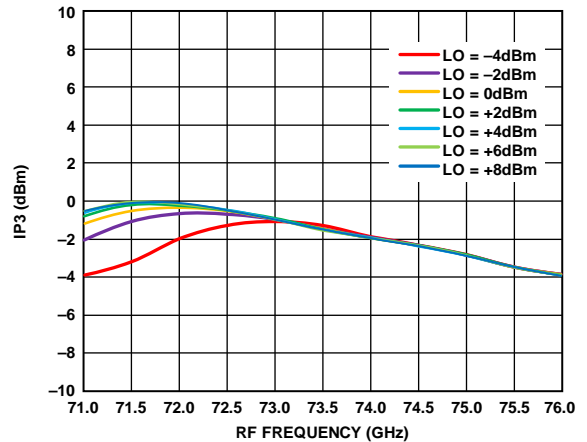

Figure 60. Input IP3 vs. RF Frequency at Various LO Powers,  $R_{FIN} = -20$  dBm,  $IF = 500$  MHz,  $V_{DLNA} = 3$  V

13128-060

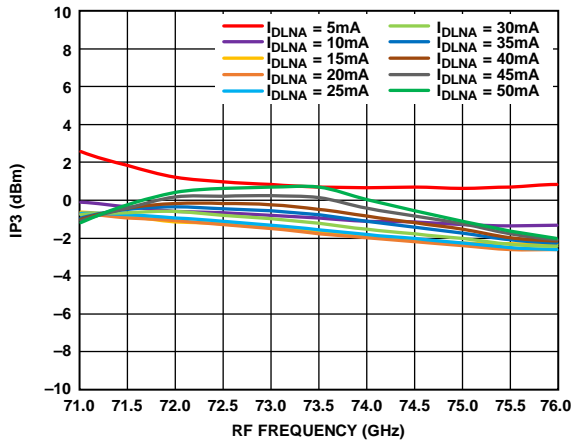

Figure 58. Input IP3 vs. RF Frequency at Various  $I_{DLNA}$  Values,  $R_{FIN} = -20$  dBm,  $LO = 2$  dBm,  $IF = 500$  MHz,  $V_{DLNA} = 4$  V

13128-058

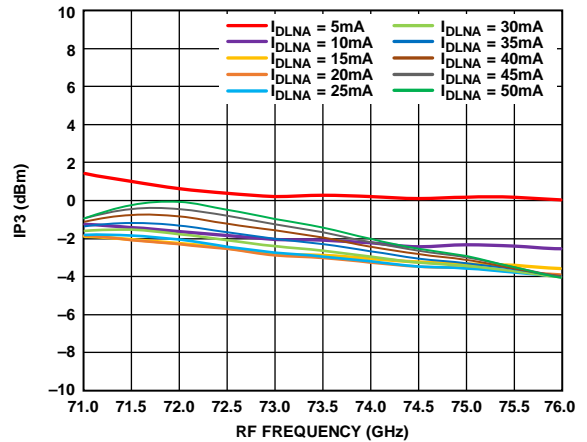

Figure 61. Input IP3 vs. RF Frequency at Various  $I_{DLNA}$  Values,  $R_{FIN} = -20$  dBm,  $LO = 2$  dBm,  $IF = 500$  MHz,  $V_{DLNA} = 3$  V

13128-061

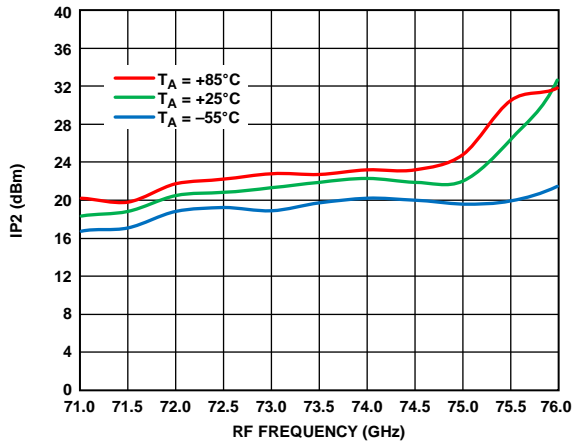

Figure 62. Input IP2 vs. RF Frequency at Various Temperatures,  $R_{FIN} = -20$  dBm, LO = 2 dBm, IF = 500 MHz,  $V_{DLNA} = 4$  V

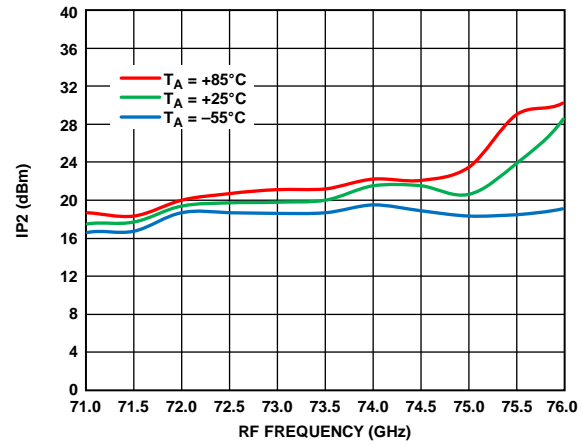

Figure 65. Input IP2 vs. RF Frequency at Various Temperatures,  $R_{FIN} = -20$  dBm, LO = 2 dBm, IF = 500 MHz,  $V_{DLNA} = 3$  V

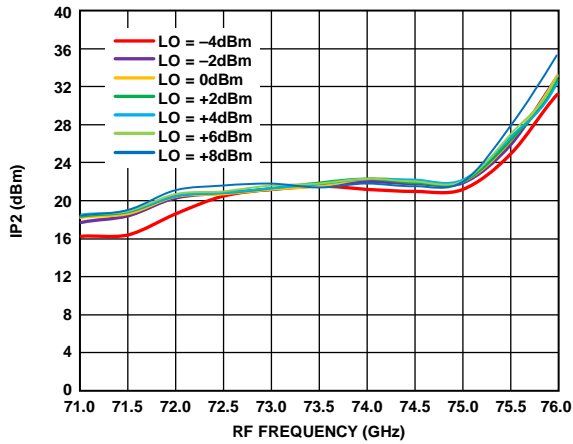

Figure 63. Input IP2 vs. RF Frequency at Various LO Powers,  $R_{FIN} = -20$  dBm, IF = 500 MHz,  $V_{DLNA} = 4$  V

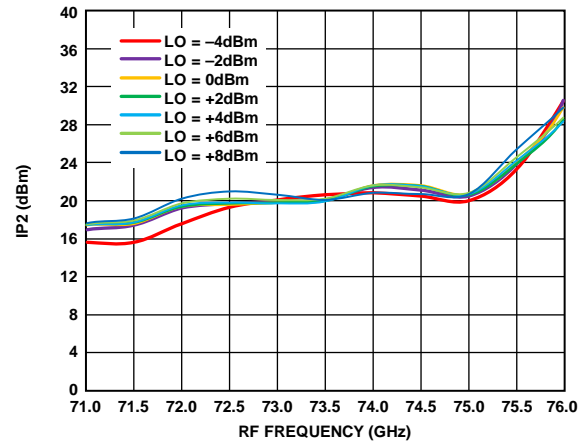

Figure 66. Input IP2 vs. RF Frequency at Various LO Powers,  $R_{FIN} = -20$  dBm, IF = 500 MHz,  $V_{DLNA} = 3$  V

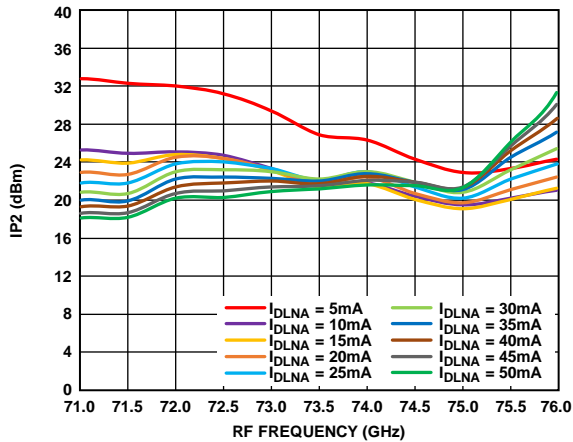

Figure 64. Input IP2 vs. RF Frequency at Various  $I_{DLNA}$  Values,  $R_{FIN} = -20$  dBm, LO = 2 dBm, IF = 500 MHz,  $V_{DLNA} = 4$  V

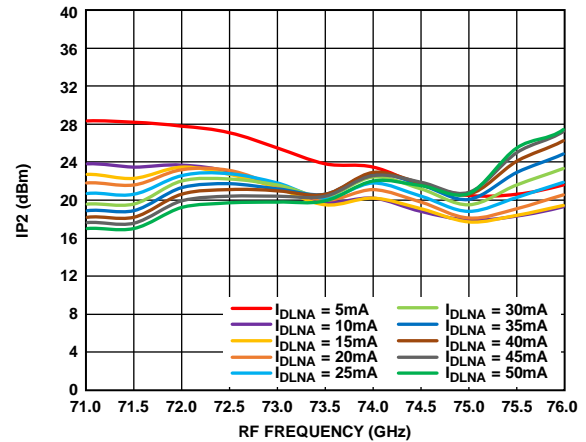

Figure 67. Input IP2 vs. RF Frequency at Various  $I_{DLNA}$  Values,  $R_{FIN} = -20$  dBm, LO = 2 dBm, IF = 500 MHz,  $V_{DLNA} = 3$  V



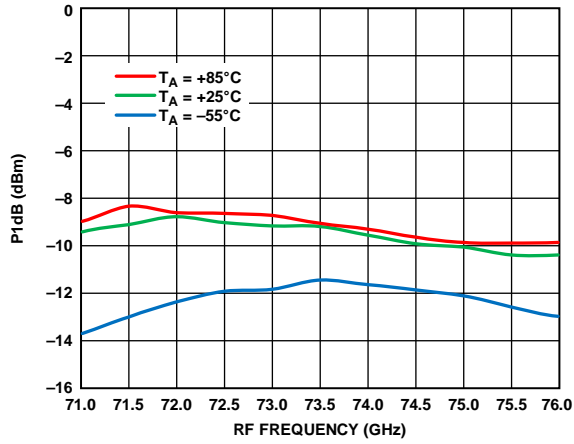

Figure 68. Input P1dB vs. RF Frequency at Various Temperatures, LO = 2 dBm, IF = 500 MHz, V<sub>DLNA</sub> = 4 V

13128-068

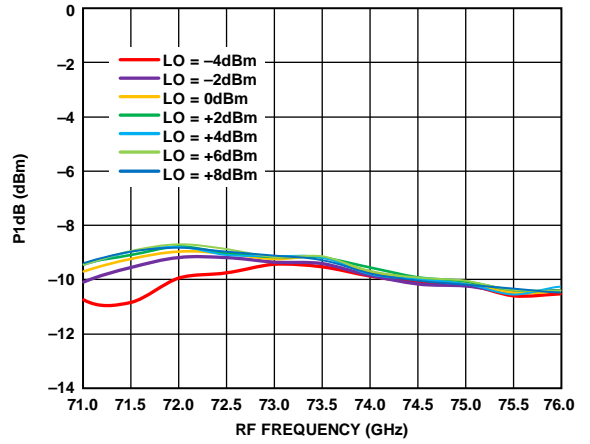

Figure 69. Input P1dB vs. RF Frequency at Various LO Powers, IF = 500 MHz, V<sub>DLNA</sub> = 4 V

13128-071

LOWER SIDEBAND SELECTED, IF = 2000 MHz

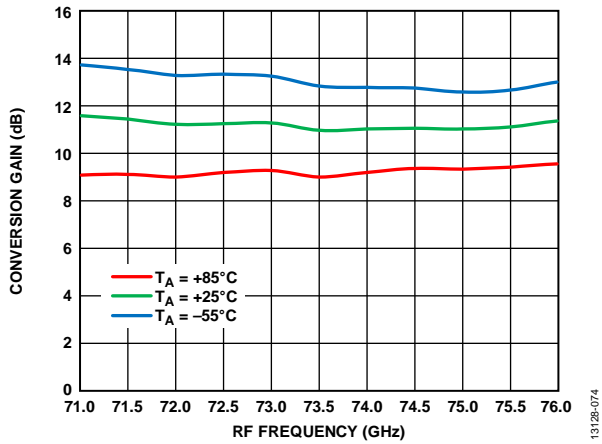

Figure 70. Conversion Gain vs. RF Frequency at Various Temperatures,  $RFIN = -20$  dBm,  $LO = 2$  dBm,  $IF = 2000$  MHz,  $V_{DLNA} = 4$  V

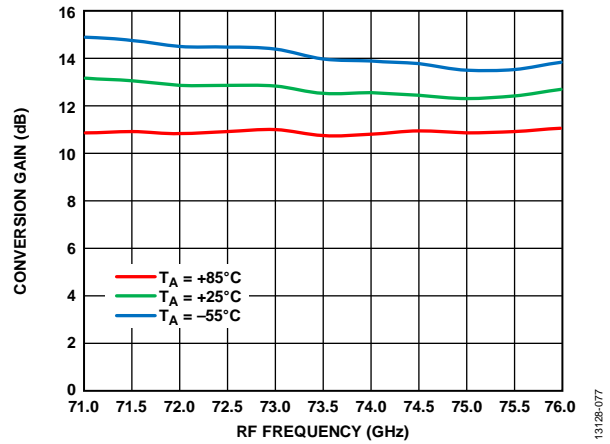

Figure 73. Conversion Gain vs. RF Frequency at Various Temperatures,  $RFIN = -20$  dBm,  $LO = 2$  dBm,  $IF = 2000$  MHz,  $V_{DLNA} = 3$  V

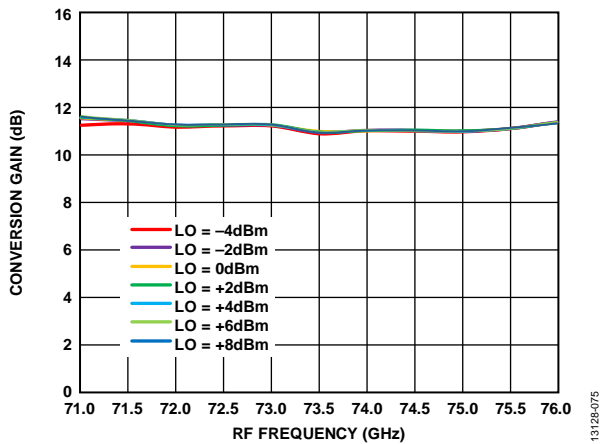

Figure 71. Conversion Gain vs. RF Frequency at Various LO Powers,  $RFIN = -20$  dBm,  $IF = 2000$  MHz,  $V_{DLNA} = 4$  V

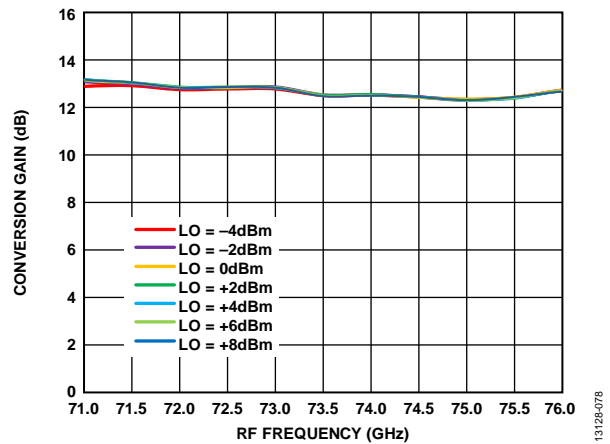

Figure 74. Conversion Gain vs. RF Frequency at Various LO Powers,  $RFIN = -20$  dBm,  $IF = 2000$  MHz,  $V_{DLNA} = 3$  V

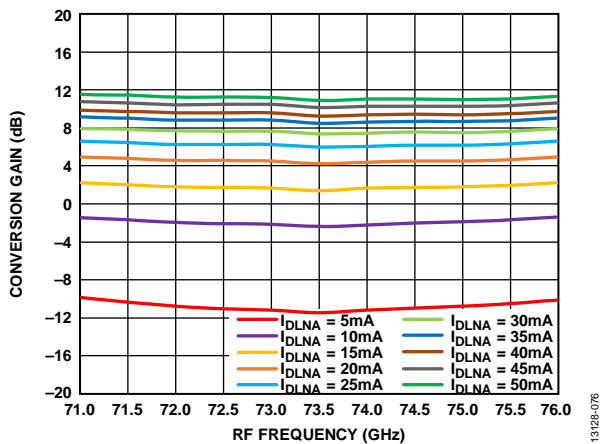

Figure 72. Conversion Gain vs. RF Frequency at Various  $I_{DLNA}$  Values,  $RFIN = -20$  dBm,  $IF = 2000$  MHz,  $V_{DLNA} = 4$  V

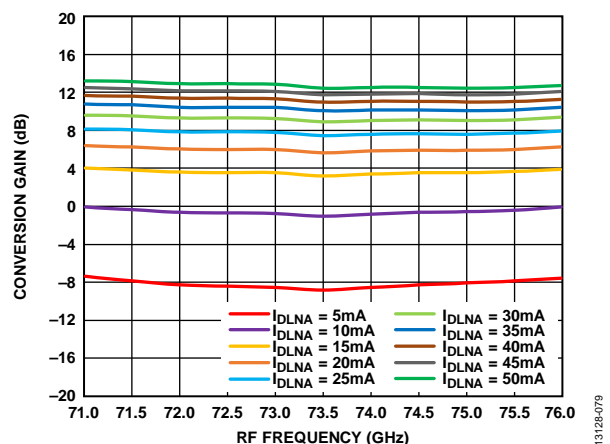

Figure 75. Conversion Gain vs. RF Frequency at Various  $I_{DLNA}$  Values,  $RFIN = -20$  dBm,  $IF = 2000$  MHz,  $V_{DLNA} = 3$  V

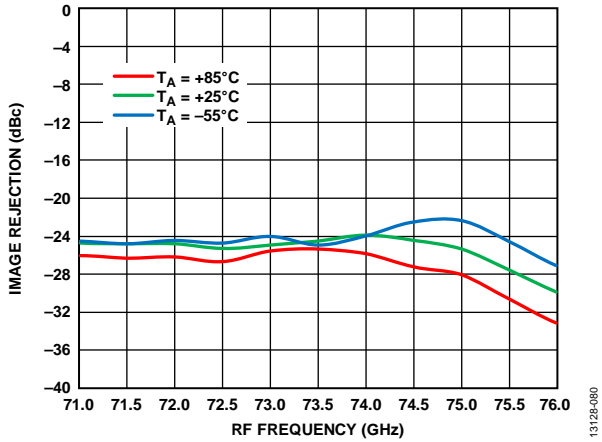

Figure 76. Image Rejection vs. RF Frequency at Various Temperatures,  $RFIN = -20\text{ dBm}$ ,  $LO = 2\text{ dBm}$ ,  $IF = 2000\text{ MHz}$ ,  $V_{DLNA} = 4\text{ V}$

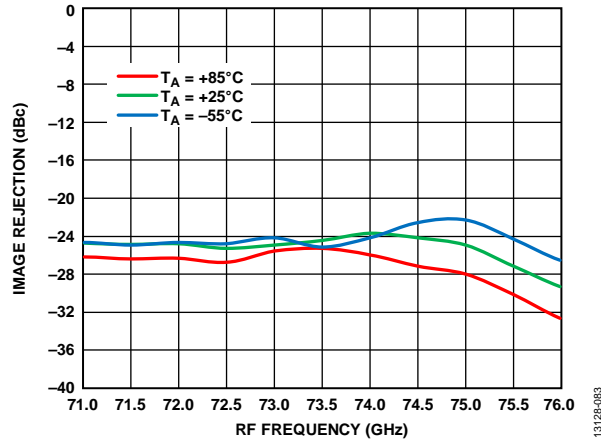

Figure 79. Image Rejection vs. RF Frequency at Various Temperatures,  $RFIN = -20\text{ dBm}$ ,  $LO = 2\text{ dBm}$ ,  $IF = 2000\text{ MHz}$ ,  $V_{DLNA} = 3\text{ V}$

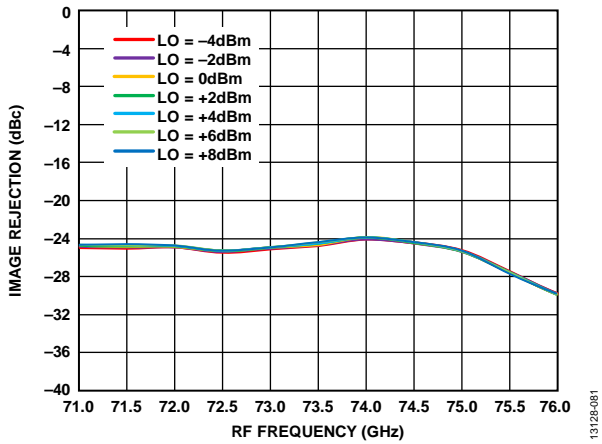

Figure 77. Image Rejection vs. RF Frequency at Various LO Powers,  $RFIN = -20\text{ dBm}$ ,  $IF = 2000\text{ MHz}$ ,  $V_{DLNA} = 4\text{ V}$

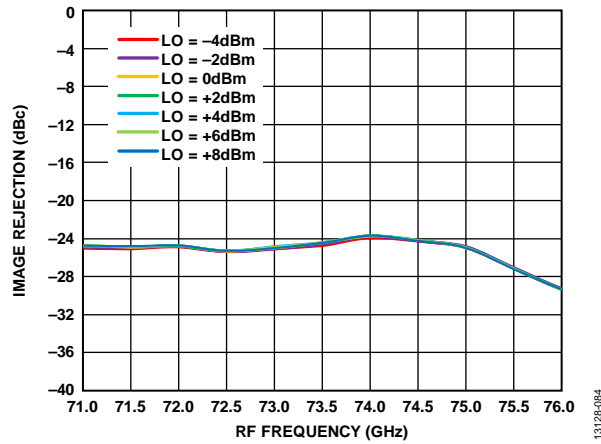

Figure 80. Image Rejection vs. RF Frequency at Various LO Powers,  $RFIN = -20\text{ dBm}$ ,  $IF = 2000\text{ MHz}$ ,  $V_{DLNA} = 3\text{ V}$

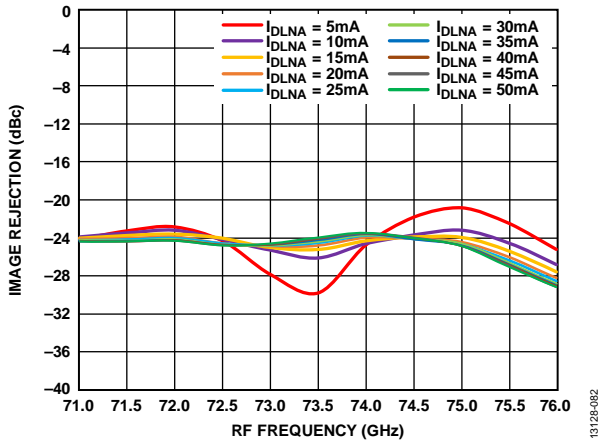

Figure 78. Image Rejection vs. RF Frequency at Various  $I_{DLNA}$  Values,  $RFIN = -20\text{ dBm}$ ,  $LO = 2\text{ dBm}$ ,  $IF = 2000\text{ MHz}$ ,  $V_{DLNA} = 4\text{ V}$

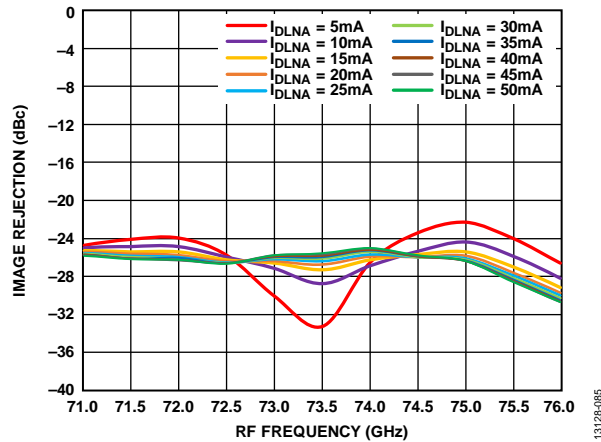

Figure 81. Image Rejection vs. RF Frequency at Various  $I_{DLNA}$  Values,  $RFIN = -20\text{ dBm}$ ,  $LO = 2\text{ dBm}$ ,  $IF = 2000\text{ MHz}$ ,  $V_{DLNA} = 3\text{ V}$

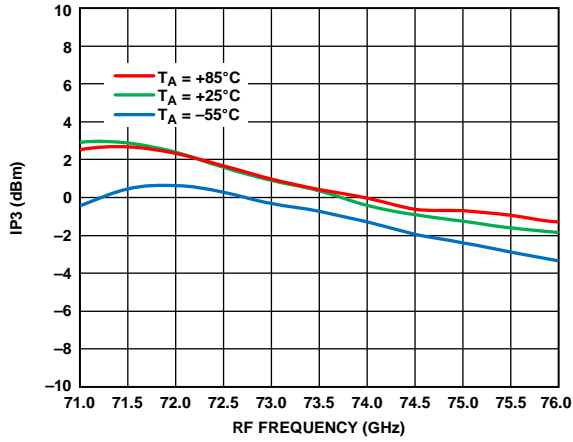

Figure 82. Input IP3 vs. RF Frequency at Various Temperatures,  $R_{FIN} = -20$  dBm,  $LO = 2$  dBm,  $IF = 2000$  MHz,  $V_{DLNA} = 4$  V

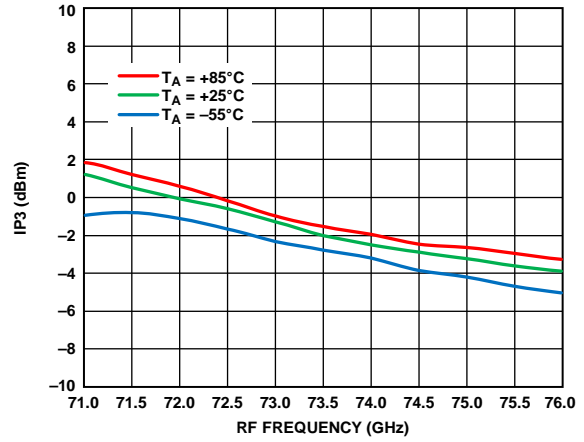

Figure 85. Input IP3 vs. RF Frequency at Various Temperatures,  $R_{FIN} = -20$  dBm,  $LO = 2$  dBm,  $IF = 2000$  MHz,  $V_{DLNA} = 3$  V

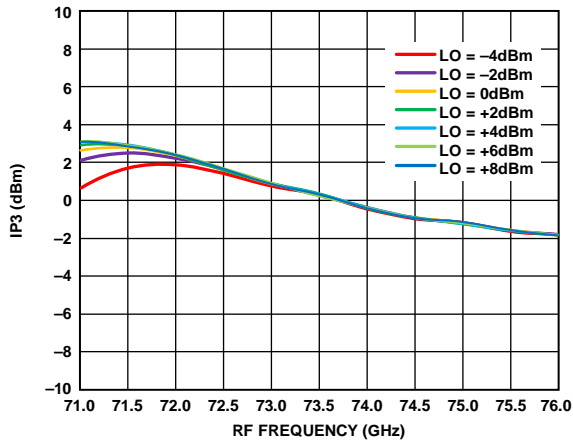

Figure 83. Input IP3 vs. RF Frequency at Various LO Powers,  $R_{FIN} = -20$  dBm,  $IF = 2000$  MHz,  $V_{DLNA} = 4$  V

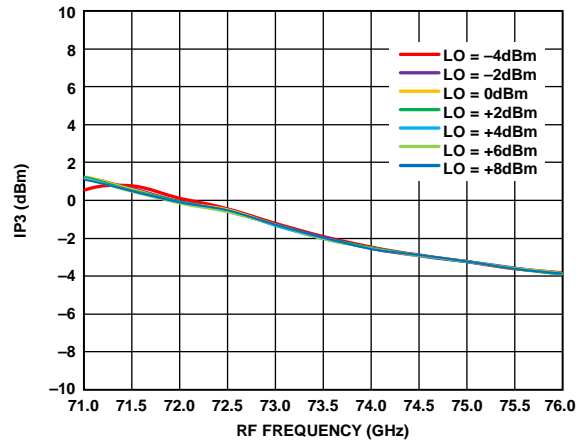

Figure 86. Input IP3 vs. RF Frequency at Various LO Powers,  $R_{FIN} = -20$  dBm,  $IF = 2000$  MHz,  $V_{DLNA} = 3$  V

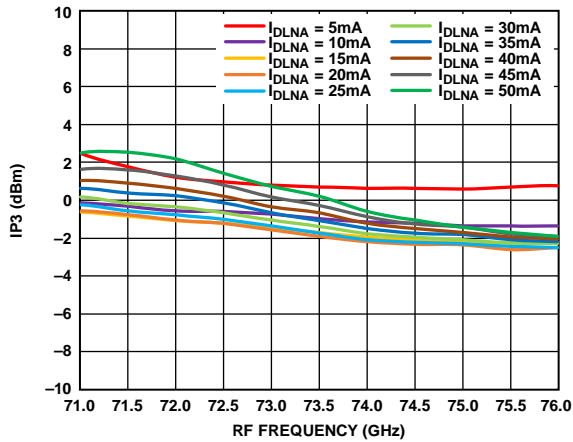

Figure 84. Input IP3 vs. RF Frequency at Various  $I_{DLNA}$  Values,  $R_{FIN} = -20$  dBm,  $LO = 2$  dBm,  $IF = 2000$  MHz,  $V_{DLNA} = 4$  V

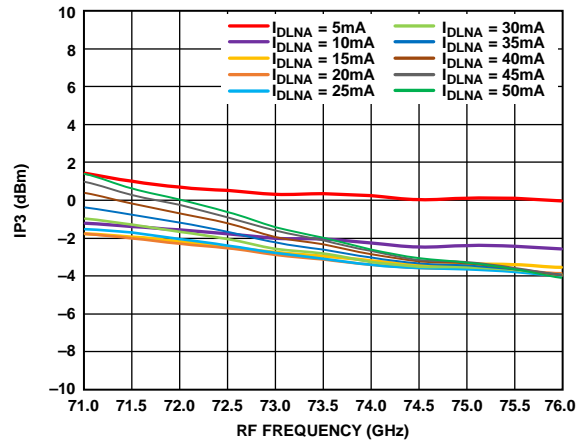

Figure 87. Input IP3 vs. RF Frequency at Various  $I_{DLNA}$  Values,  $R_{FIN} = -20$  dBm,  $LO = 2$  dBm,  $IF = 2000$  MHz,  $V_{DLNA} = 3$  V

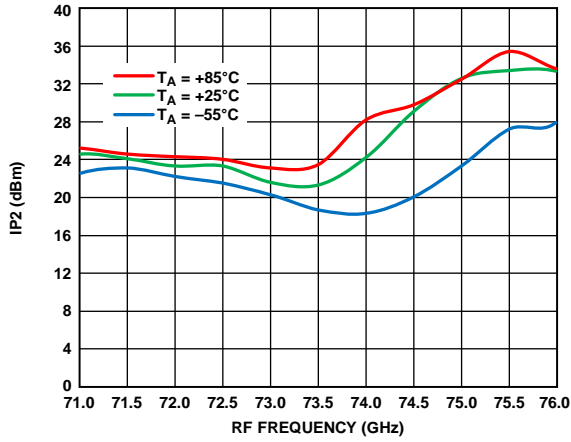

Figure 88. Input IP2 vs. RF Frequency at Various Temperatures,  $R_{FIN} = -20$  dBm,  $LO = 2$  dBm,  $IF = 2000$  MHz,  $V_{DLNA} = 4$  V

13128-092

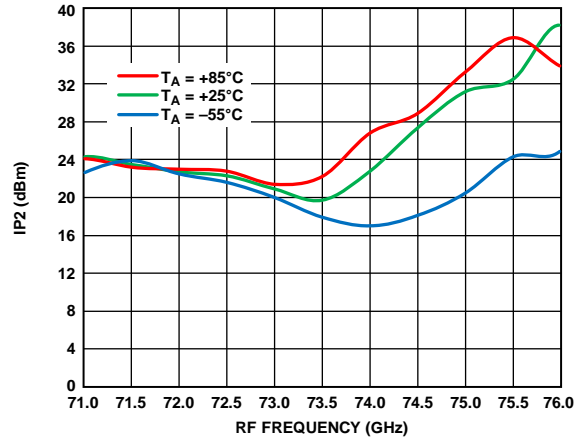

Figure 91. Input IP2 vs. RF Frequency at Various Temperatures,  $R_{FIN} = -20$  dBm,  $LO = 2$  dBm,  $IF = 2000$  MHz,  $V_{DLNA} = 3$  V

13128-095

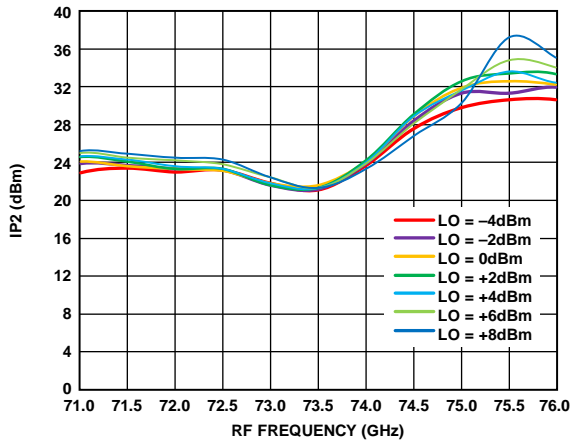

Figure 89. Input IP2 vs. RF Frequency at Various LO Powers,  $R_{FIN} = -20$  dBm,  $IF = 2000$  MHz,  $V_{DLNA} = 4$  V

13128-093

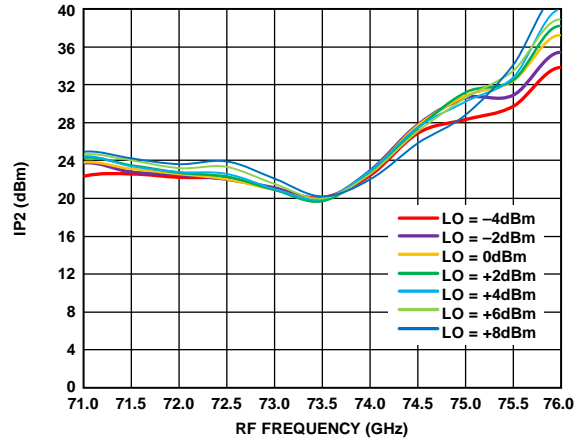

Figure 92. Input IP2 vs. RF Frequency at Various LO Powers,  $R_{FIN} = -20$  dBm,  $IF = 2000$  MHz,  $V_{DLNA} = 3$  V

13128-096

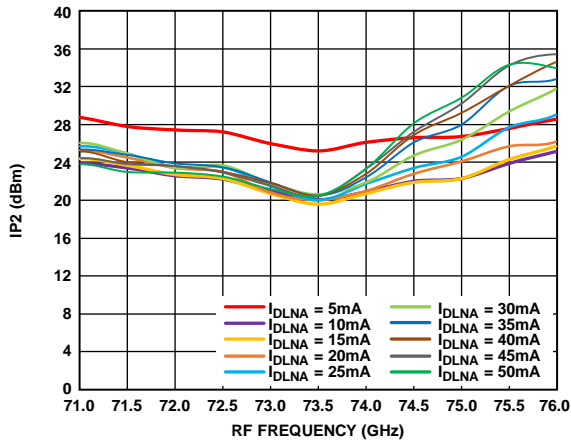

Figure 90. Input IP2 vs. RF Frequency at Various  $I_{DLNA}$  Values,  $R_{FIN} = -20$  dBm,  $LO = 2$  dBm,  $IF = 2000$  MHz,  $V_{DLNA} = 4$  V

13128-094

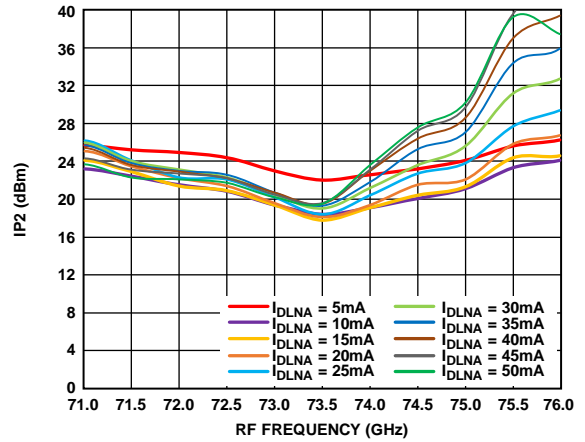

Figure 93. Input IP2 vs. RF Frequency at Various  $I_{DLNA}$  Values,  $R_{FIN} = -20$  dBm,  $LO = 2$  dBm,  $IF = 2000$  MHz,  $V_{DLNA} = 3$  V

13128-097

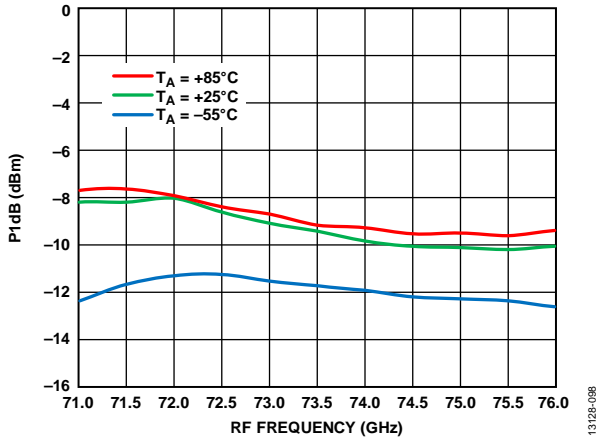

Figure 94. Input P1dB vs. RF Frequency at Various Temperatures, LO = 2 dBm, IF = 2000 MHz, V<sub>DLNA</sub> = 4 V

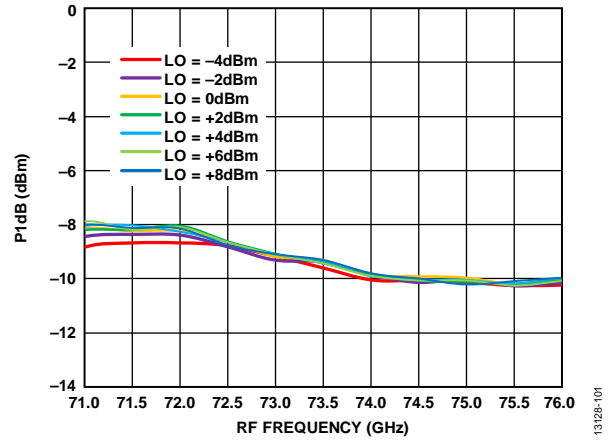

Figure 95. Input P1dB vs. RF Frequency at Various LO Powers, IF = 2000 MHz, V<sub>DLNA</sub> = 4 V

1312E-098

1312E-101

**NOISE FIGURE PERFORMANCE, LOWER SIDEBAND SELECTED**

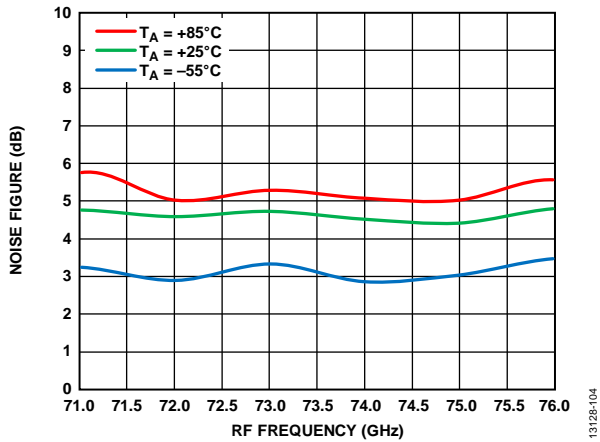

Figure 96. Noise Figure vs. RF Frequency at Various Temperatures, LO = 2 dBm, IF = 500 MHz,  $V_{DLNA} = 3 V$

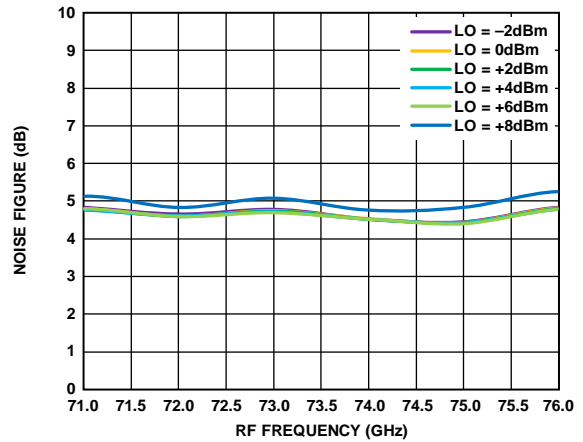

Figure 99. Noise Figure vs. RF Frequency at Various LO Powers, IF = 500 MHz,  $V_{DLNA} = 3 V$

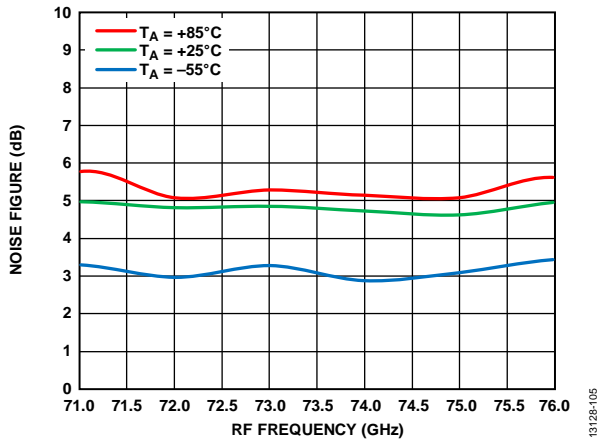

Figure 97. Noise Figure vs. RF Frequency at Various Temperatures, LO = 2 dBm, IF = 1000 MHz,  $V_{DLNA} = 3 V$

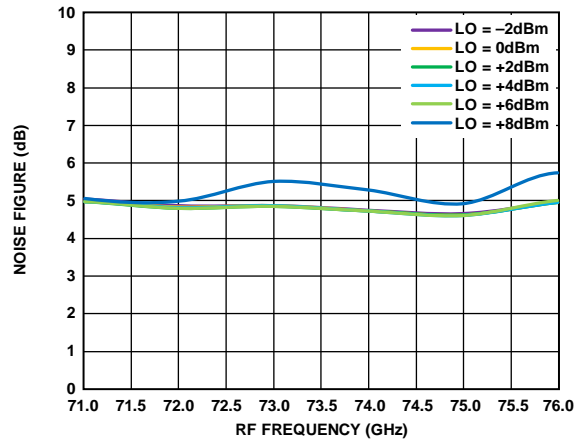

Figure 100. Noise Figure vs. RF Frequency at Various LO Powers, IF = 1000 MHz,  $V_{DLNA} = 3 V$

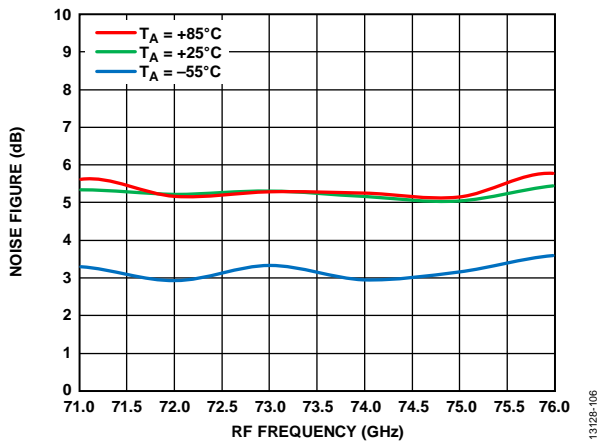

Figure 98. Noise Figure vs. RF Frequency at Various Temperatures, LO = 2 dBm, IF = 2000 MHz,  $V_{DLNA} = 3 V$

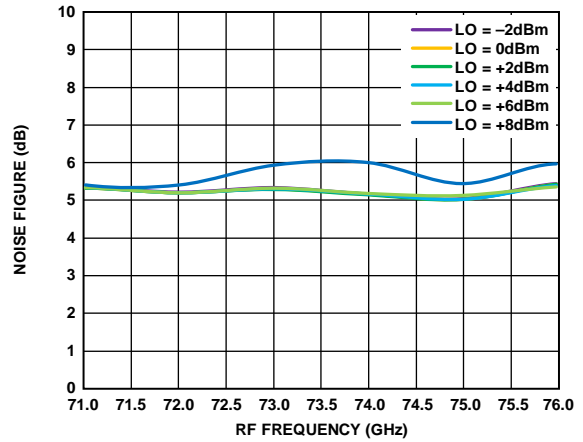

Figure 101. Noise Figure vs. RF Frequency at Various LO Powers, IF = 2000 MHz,  $V_{DLNA} = 3 V$

AMPLITUDE BALANCE PERFORMANCE, LOWER SIDEBAND SELECTED

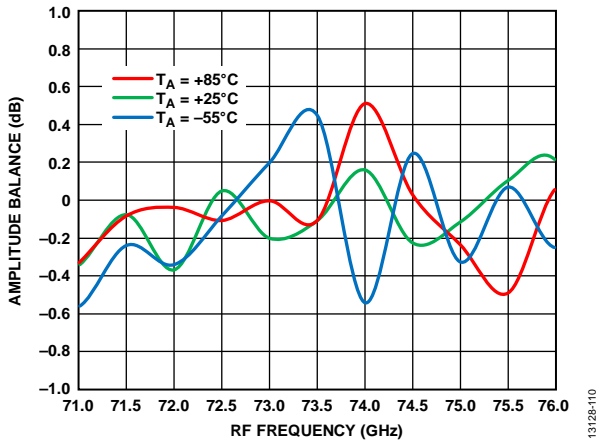

Figure 102. Amplitude Balance vs. RF Frequency at Various Temperatures, RFIN = -20 dBm, LO = 2 dBm, IF = 500 MHz, VDLNA = 4 V

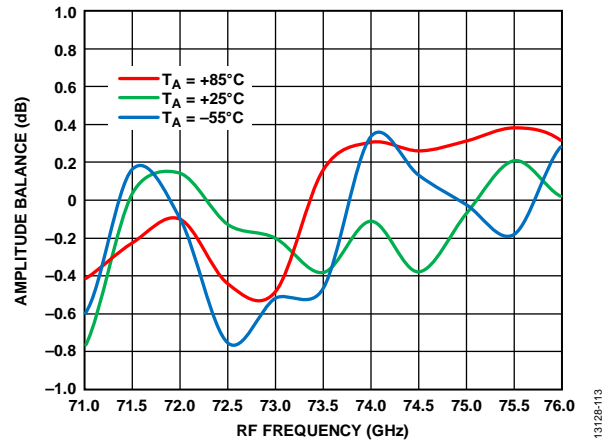

Figure 105. Amplitude Balance vs. RF Frequency at Various Temperatures, RFIN = -20 dBm, LO = 2 dBm, IF = 500 MHz, VDLNA = 3 V

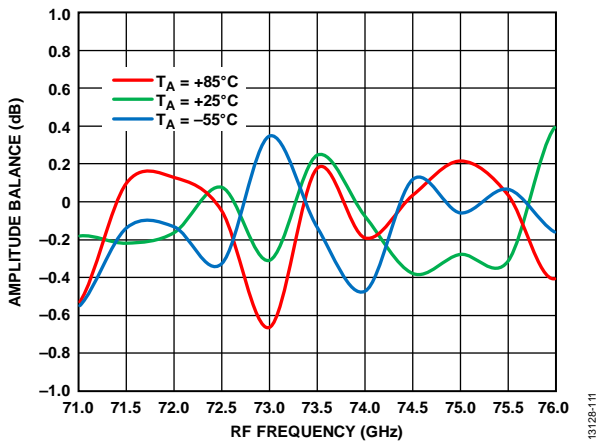

Figure 103. Amplitude Balance vs. RF Frequency at Various Temperatures, RFIN = -20 dBm, LO = 2 dBm, IF = 1000 MHz, VDLNA = 4 V

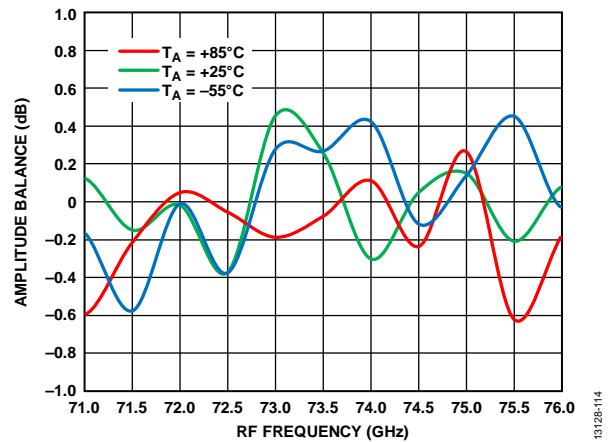

Figure 106. Amplitude Balance vs. RF Frequency at Various Temperatures, RFIN = -20 dBm, LO = 2 dBm, IF = 1000 MHz, VDLNA = 3 V

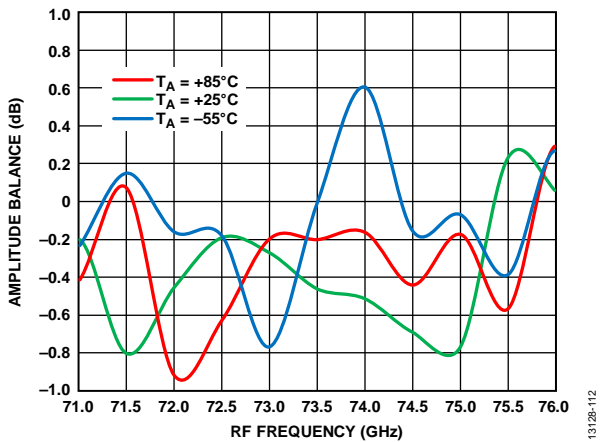

Figure 104. Amplitude Balance vs. RF Frequency at Various Temperatures, RFIN = -20 dBm, LO = 2 dBm, IF = 2000 MHz, VDLNA = 4 V

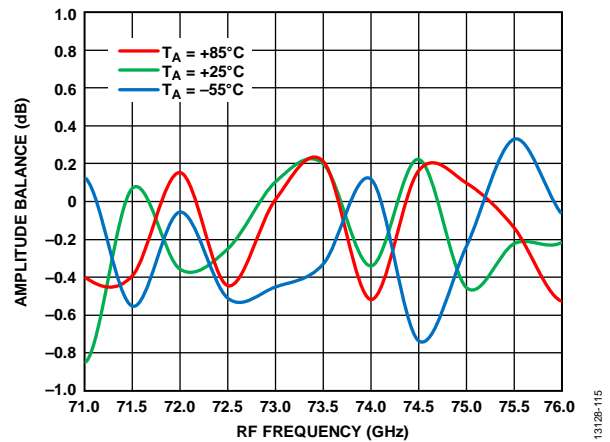

Figure 107. Amplitude Balance vs. RF Frequency at Various Temperatures, RFIN = -20 dBm, LO = 2 dBm, IF = 2000 MHz, VDLNA = 3 V



PHASE BALANCE PERFORMANCE, LOWER SIDEBAND SELECTED

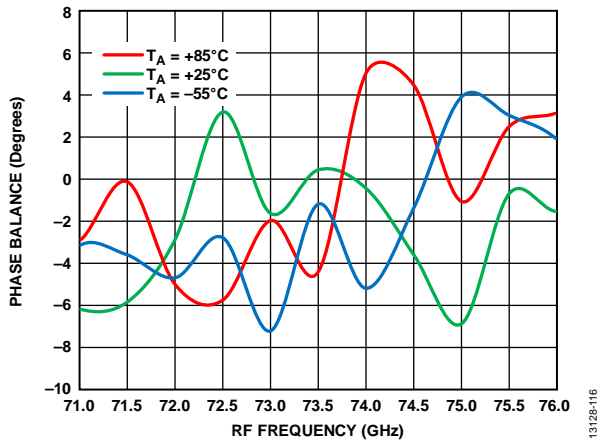

Figure 108. Phase Balance vs. RF Frequency at Various Temperatures, RFIN = -20 dBm, LO = 2 dBm, IF = 500 MHz, VDLNA = 4 V

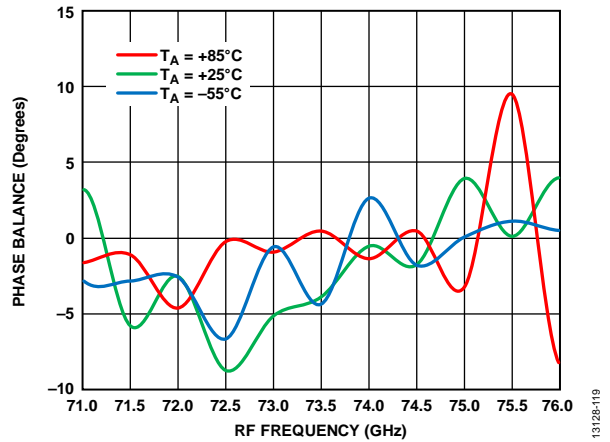

Figure 111. Phase Balance vs. RF Frequency at Various Temperatures, RFIN = -20 dBm, LO = 2 dBm, IF = 500 MHz, VDLNA = 3 V

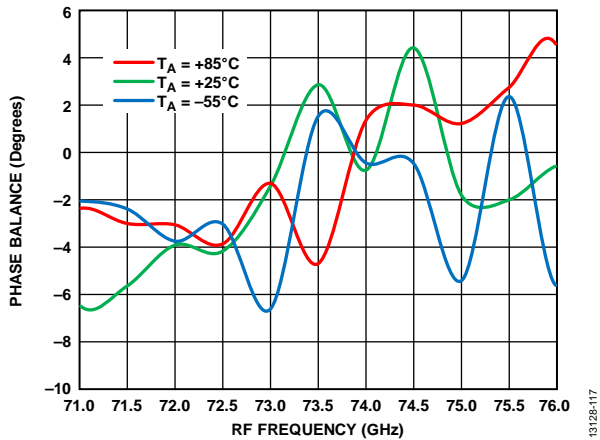

Figure 109. Phase Balance vs. RF Frequency at Various Temperatures, RFIN = -20 dBm, LO = 2 dBm, IF = 1000 MHz, VDLNA = 4 V

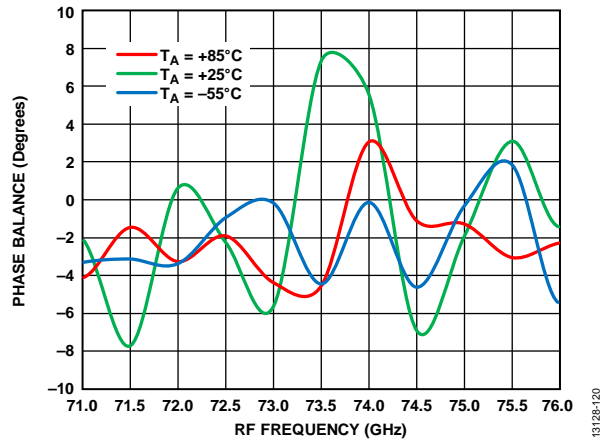

Figure 112. Phase Balance vs. RF Frequency at Various Temperatures, RFIN = -20 dBm, LO = 2 dBm, IF = 1000 MHz, VDLNA = 3 V

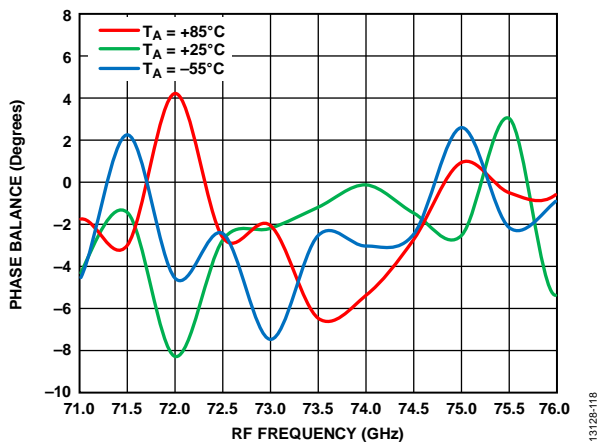

Figure 110. Phase Balance vs. RF Frequency at Various Temperatures, RFIN = -20 dBm, LO = 2 dBm, IF = 2000 MHz, VDLNA = 4 V

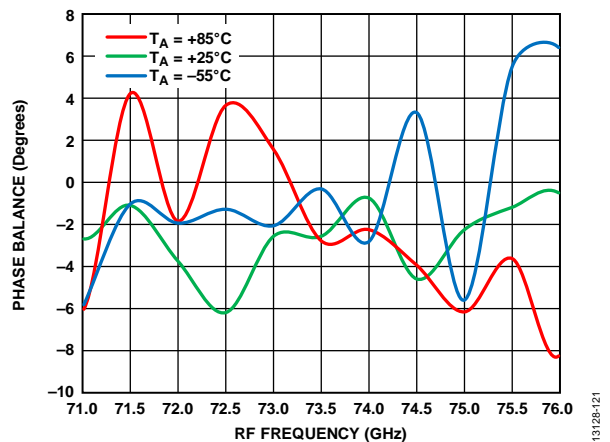
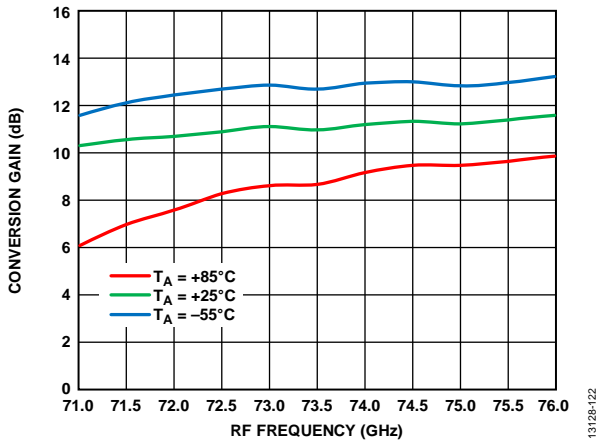

Figure 113. Phase Balance vs. RF Frequency at Various Temperatures, RFIN = -20 dBm, LO = 2 dBm, IF = 2000 MHz, VDLNA = 3 V

UPPER SIDEBAND SELECTED, IF = 500 MHz



13128-122

Figure 114. Conversion Gain vs. RF Frequency at Various Temperatures,  $R_{FIN} = -20$  dBm,  $L_O = 2$  dBm,  $I_F = 500$  MHz,  $V_{DLNA} = 4$  V

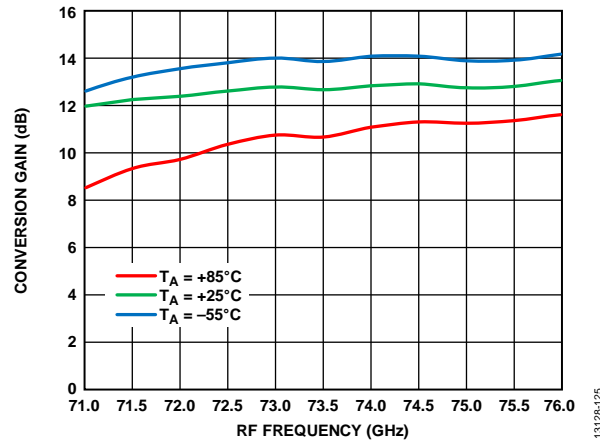

13128-125

Figure 117. Conversion Gain vs. RF Frequency at Various Temperatures,  $R_{FIN} = -20$  dBm,  $L_O = 2$  dBm,  $I_F = 500$  MHz,  $V_{DLNA} = 3$  V

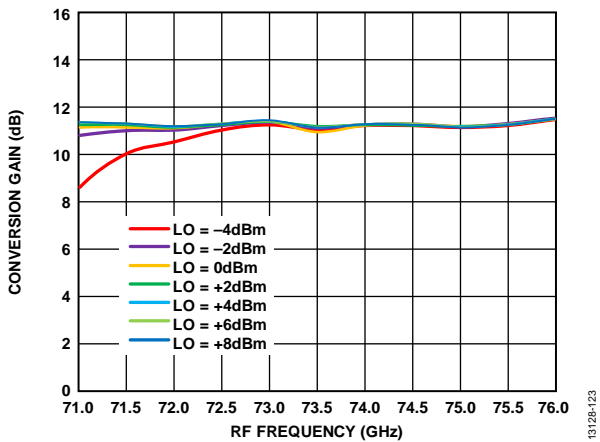

13128-123

Figure 115. Conversion Gain vs. RF Frequency at Various LO Powers,  $R_{FIN} = -20$  dBm,  $I_F = 500$  MHz,  $V_{DLNA} = 4$  V

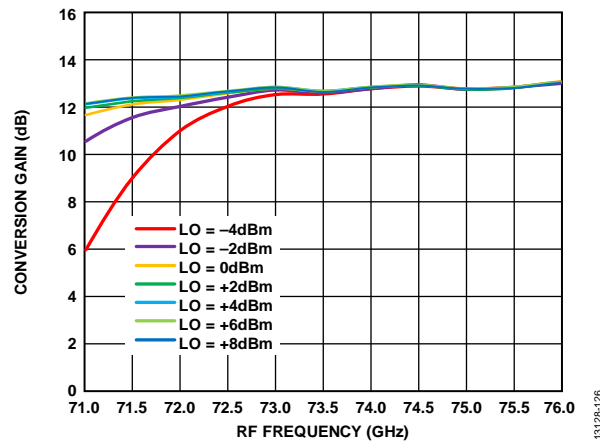

13128-126

Figure 118. Conversion Gain vs. RF Frequency at Various LO Powers,  $R_{FIN} = -20$  dBm,  $I_F = 500$  MHz,  $V_{DLNA} = 3$  V

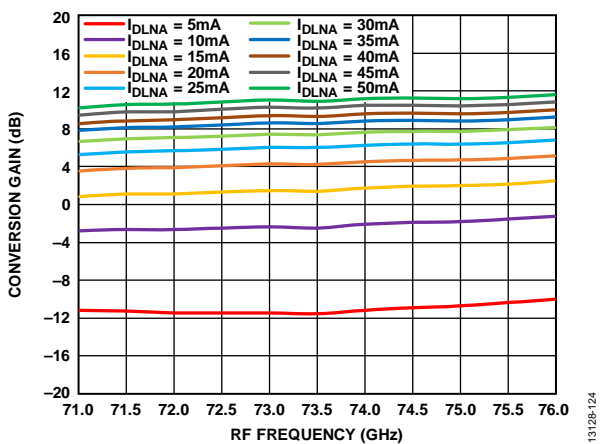

13128-124

Figure 116. Conversion Gain vs. RF Frequency at Various  $I_{DLNA}$  Values,  $R_{FIN} = -20$  dBm,  $I_F = 500$  MHz,  $V_{DLNA} = 4$  V

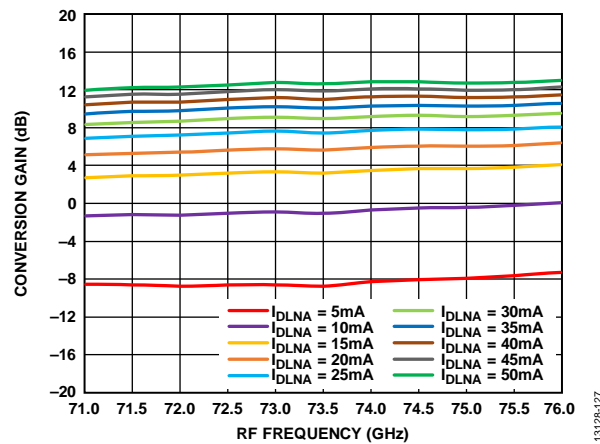

13128-127

Figure 119. Conversion Gain vs. RF Frequency at Various  $I_{DLNA}$  Values,  $R_{FIN} = -20$  dBm,  $I_F = 500$  MHz,  $V_{DLNA} = 3$  V

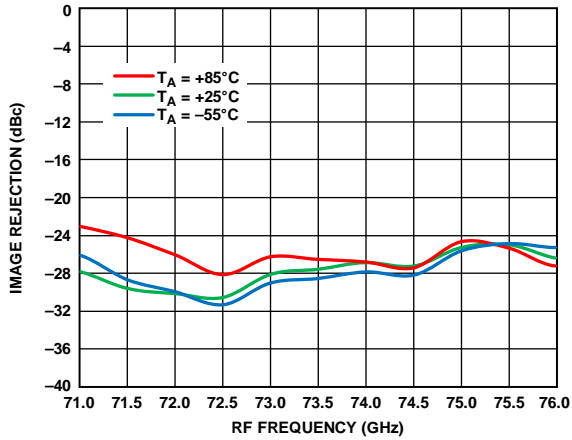

Figure 120. Image Rejection vs. RF Frequency at Various Temperatures,  $RFIN = -20\text{ dBm}$ ,  $LO = 2\text{ dBm}$ ,  $IF = 500\text{ MHz}$ ,  $V_{DLNA} = 4\text{ V}$

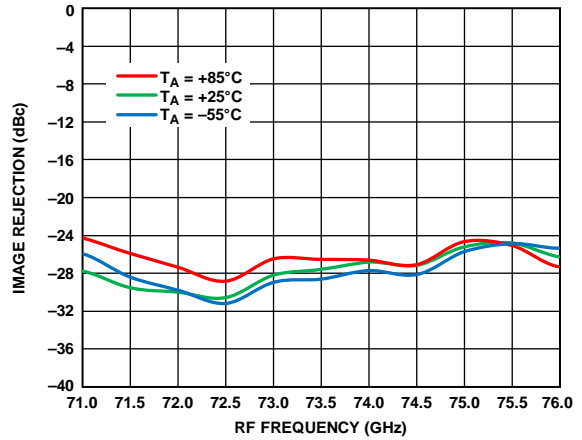

Figure 123. Image Rejection vs. RF Frequency at Various Temperatures,  $RFIN = -20\text{ dBm}$ ,  $LO = 2\text{ dBm}$ ,  $IF = 500\text{ MHz}$ ,  $V_{DLNA} = 3\text{ V}$

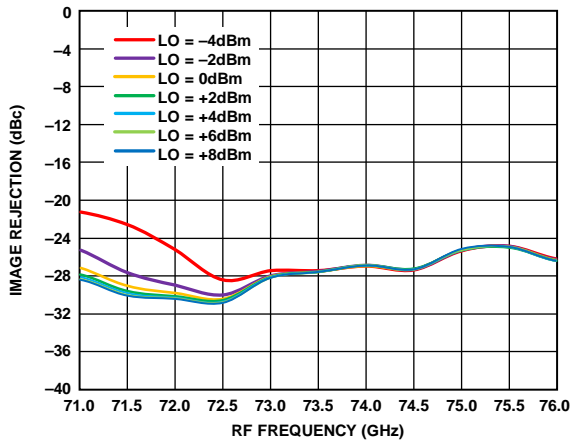

Figure 121. Image Rejection vs. RF Frequency at Various LO Powers,  $RFIN = -20\text{ dBm}$ ,  $IF = 500\text{ MHz}$ ,  $V_{DLNA} = 4\text{ V}$

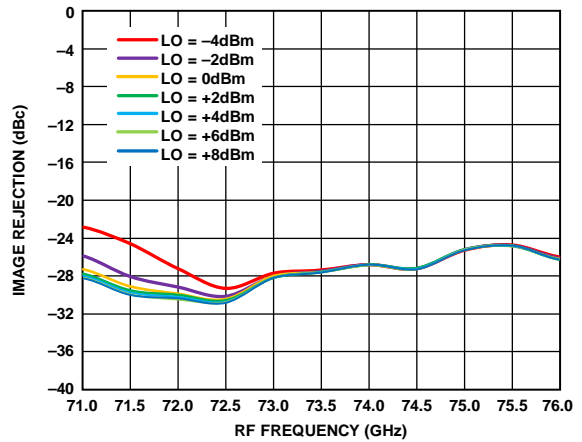

Figure 124. Image Rejection vs. RF Frequency at Various LO Powers,  $RFIN = -20\text{ dBm}$ ,  $IF = 500\text{ MHz}$ ,  $V_{DLNA} = 3\text{ V}$

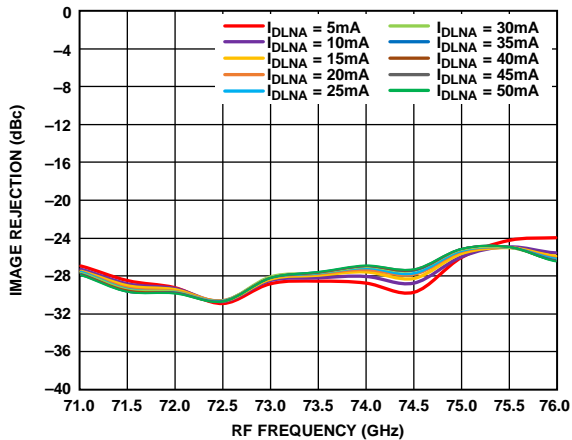

Figure 122. Image Rejection vs. RF Frequency at Various  $I_{DLNA}$  Values,  $RFIN = -20\text{ dBm}$ ,  $LO = 2\text{ dBm}$ ,  $IF = 500\text{ MHz}$ ,  $V_{DLNA} = 4\text{ V}$

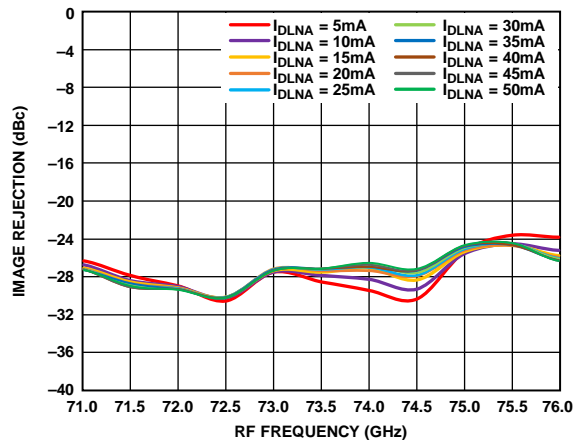
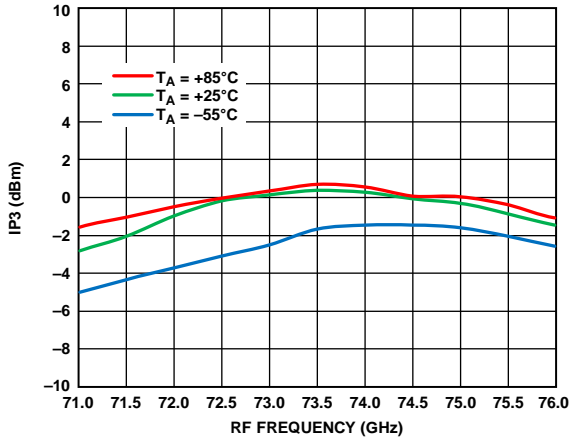
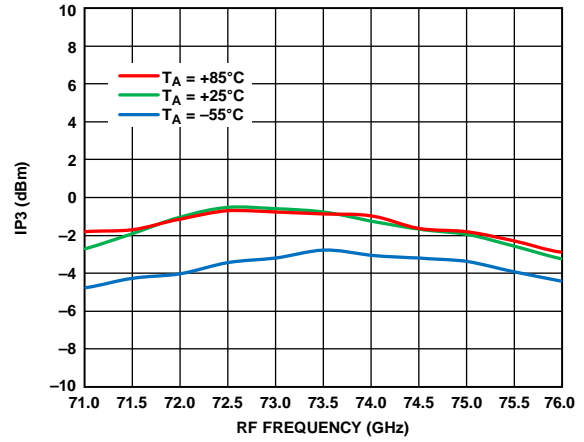

Figure 125. Image Rejection vs. RF Frequency at Various  $I_{DLNA}$  Values,  $RFIN = -20\text{ dBm}$ ,  $LO = 2\text{ dBm}$ ,  $IF = 500\text{ MHz}$ ,  $V_{DLNA} = 3\text{ V}$



13128-134

Figure 126. Input IP3 vs. RF Frequency at Various Temperatures,  $R_{FIN} = -20$  dBm,  $LO = 2$  dBm,  $IF = 500$  MHz,  $V_{DLNA} = 4$  V



13128-137

Figure 129. Input IP3 vs. RF Frequency at Various Temperatures,  $R_{FIN} = -20$  dBm,  $LO = 2$  dBm,  $IF = 500$  MHz,  $V_{DLNA} = 3$  V

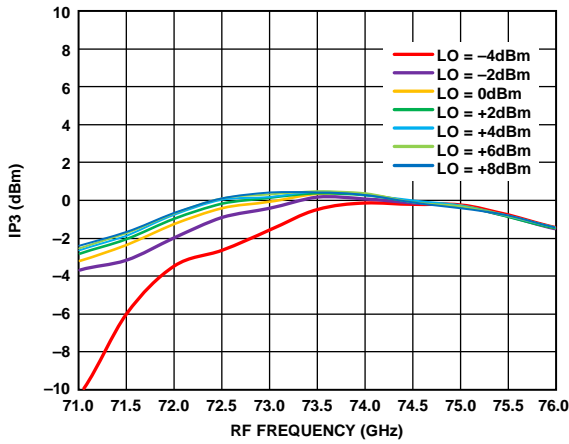

13128-135

Figure 127. Input IP3 vs. RF Frequency at Various LO Powers,  $R_{FIN} = -20$  dBm,  $IF = 500$  MHz,  $V_{DLNA} = 4$  V

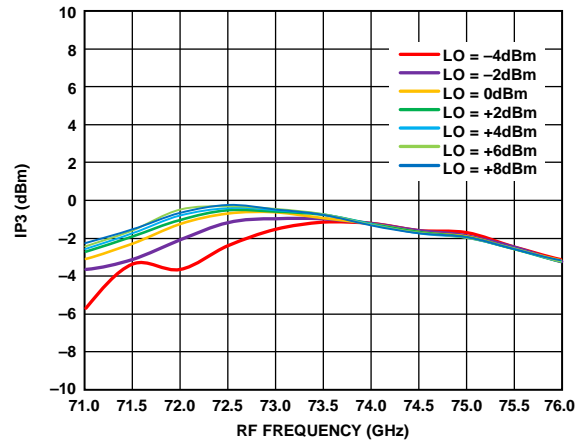

13128-138

Figure 130. Input IP3 vs. RF Frequency at Various LO Powers,  $R_{FIN} = -20$  dBm,  $IF = 500$  MHz,  $V_{DLNA} = 3$  V

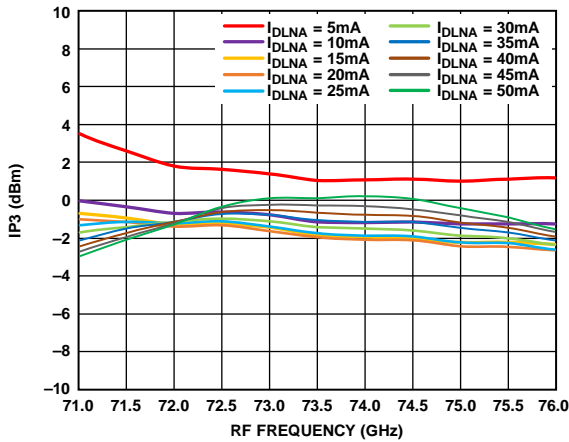

13128-136

Figure 128. Input IP3 vs. RF Frequency at Various  $I_{DLNA}$  Values,  $R_{FIN} = -20$  dBm,  $LO = 2$  dBm,  $IF = 500$  MHz,  $V_{DLNA} = 4$  V

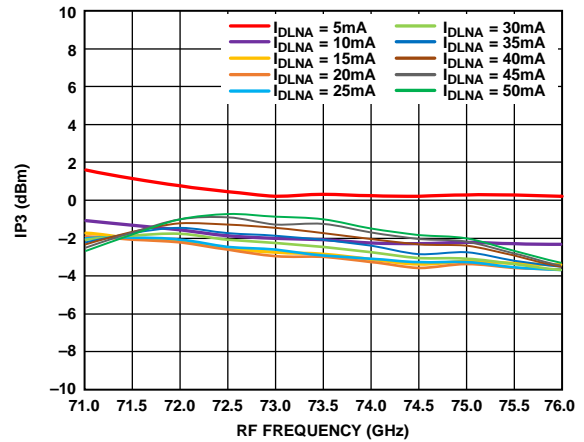

13128-139

Figure 131. Input IP3 vs. RF Frequency at Various  $I_{DLNA}$  Values,  $R_{FIN} = -20$  dBm,  $LO = 2$  dBm,  $IF = 500$  MHz,  $V_{DLNA} = 3$  V

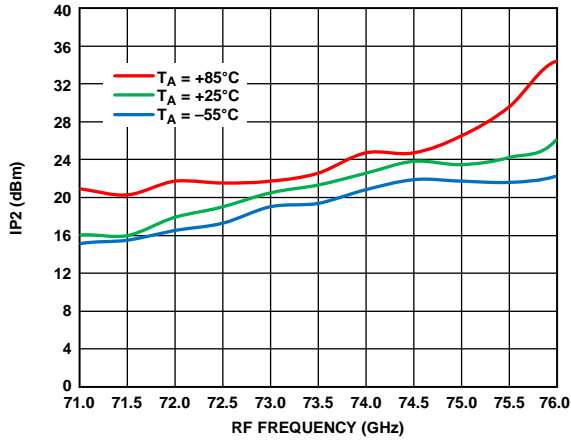

Figure 132. Input IP2 vs. RF Frequency at Various Temperatures,  $R_{FIN} = -20$  dBm,  $LO = 2$  dBm,  $IF = 500$  MHz,  $V_{DLNA} = 4$  V

13128-140

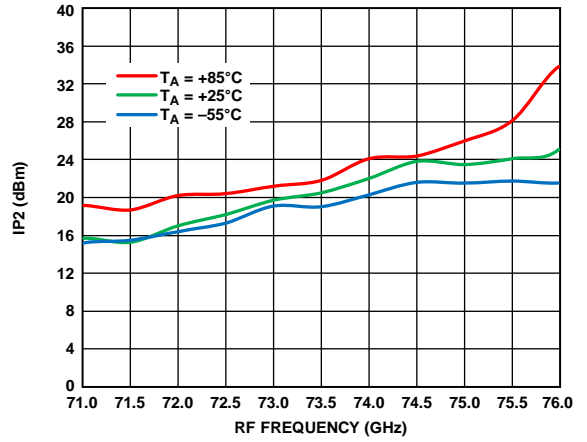

Figure 135. Input IP2 vs. RF Frequency at Various Temperatures,  $R_{FIN} = -20$  dBm,  $LO = 2$  dBm,  $IF = 500$  MHz,  $V_{DLNA} = 3$  V

13128-143

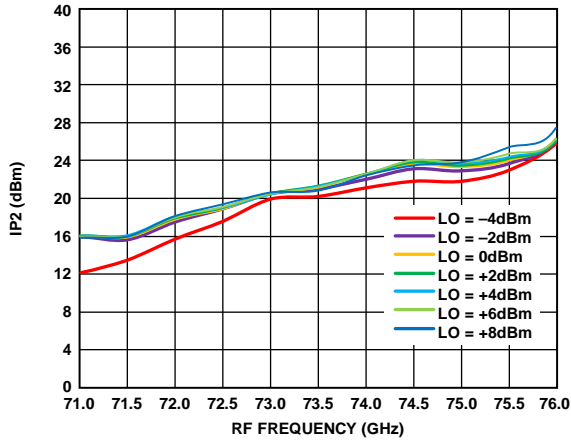

Figure 133. Input IP2 vs. RF Frequency at Various LO Powers,  $R_{FIN} = -20$  dBm,  $IF = 500$  MHz,  $V_{DLNA} = 4$  V

13128-141

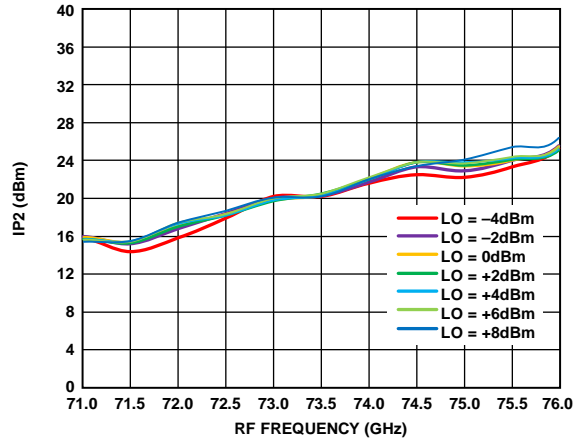

Figure 136. Input IP2 vs. RF Frequency at Various LO Powers,  $R_{FIN} = -20$  dBm,  $IF = 500$  MHz,  $V_{DLNA} = 3$  V

13128-144

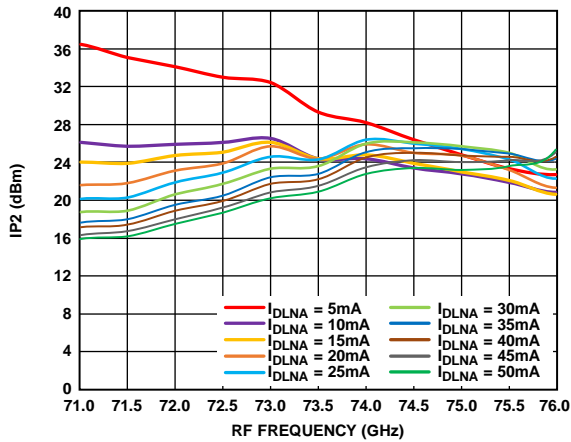

Figure 134. Input IP2 vs. RF Frequency at Various  $I_{DLNA}$  Values,  $R_{FIN} = -20$  dBm,  $LO = 2$  dBm,  $IF = 500$  MHz,  $V_{DLNA} = 4$  V

13128-142

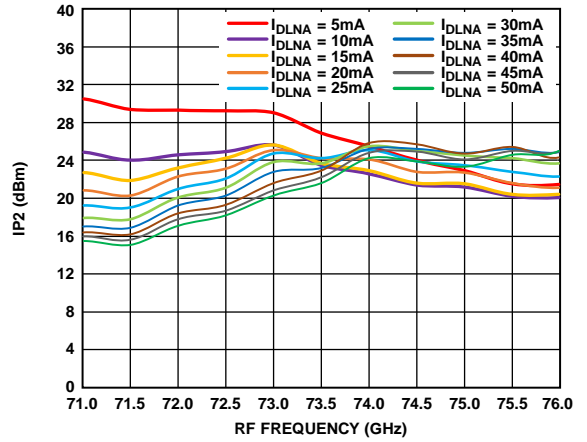

Figure 137. Input IP2 vs. RF Frequency at Various  $I_{DLNA}$  Values,  $R_{FIN} = -20$  dBm,  $LO = 2$  dBm,  $IF = 500$  MHz,  $V_{DLNA} = 3$  V

13128-145

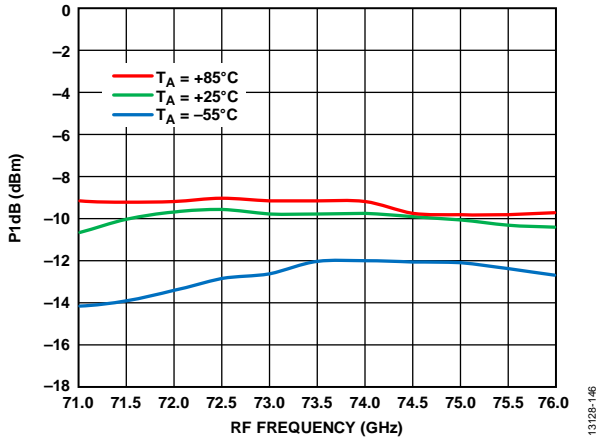

Figure 138. Input P1dB vs. RF Frequency at Various Temperatures, LO = 2 dBm, IF = 500 MHz,  $V_{DLNA} = 4 V$

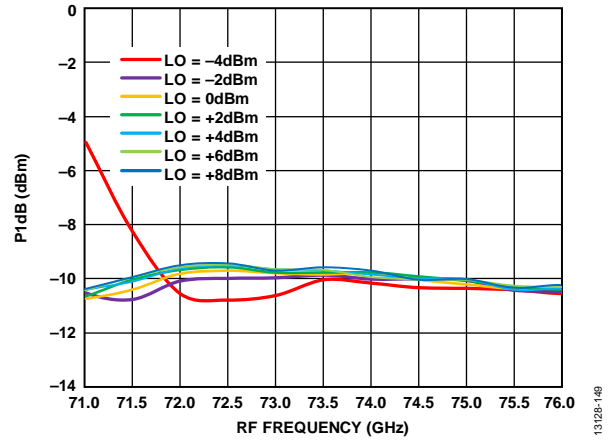

Figure 139. Input P1dB vs. RF Frequency at Various LO Powers, IF = 500 MHz,  $V_{DLNA} = 4 V$

UPPER SIDEBAND SELECTED, IF = 1000 MHz

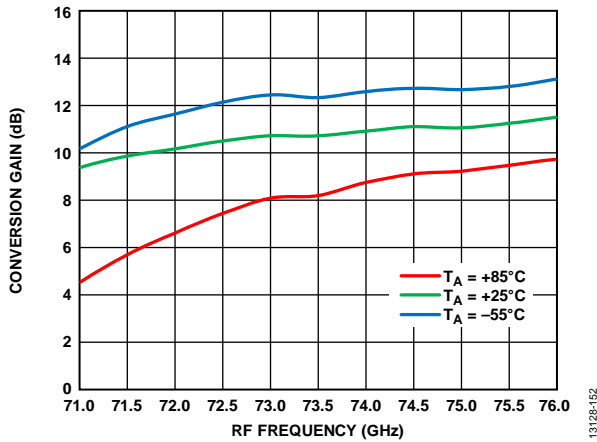

Figure 140. Conversion Gain vs. RF Frequency at Various Temperatures, RFIN = -20 dBm, LO = 2 dBm, IF = 1000 MHz, V<sub>DLNA</sub> = 4 V

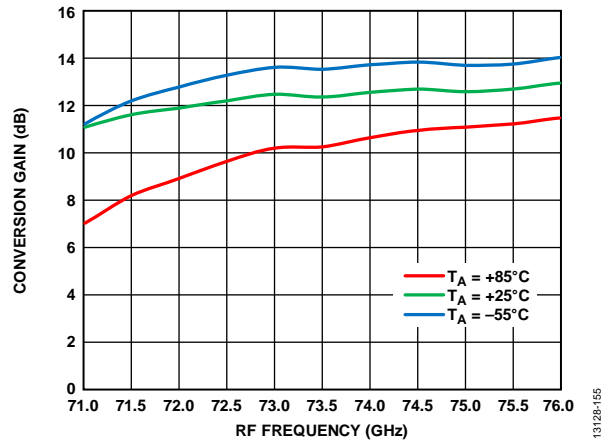

Figure 143. Conversion Gain vs. RF Frequency at Various Temperatures, RFIN = -20 dBm, LO = 2 dBm, IF = 1000 MHz, V<sub>DLNA</sub> = 3 V

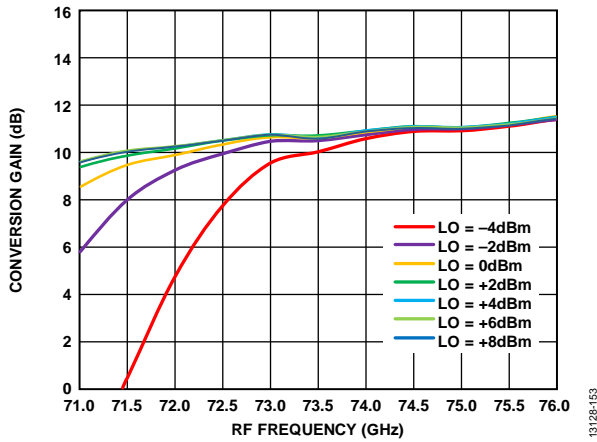

Figure 141. Conversion Gain vs. RF Frequency at Various LO Powers, RFIN = -20 dBm, IF = 1000 MHz, V<sub>DLNA</sub> = 4 V

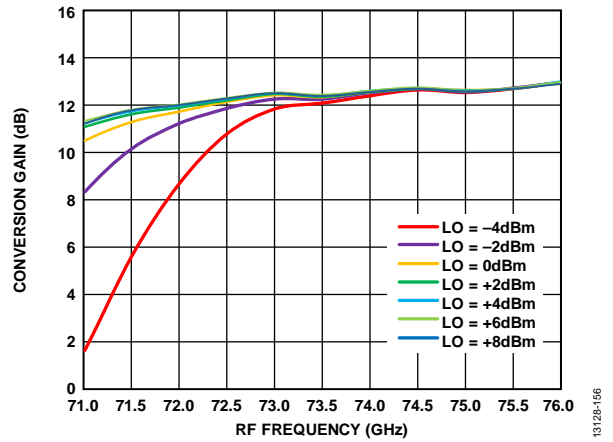

Figure 144. Conversion Gain vs. RF Frequency at Various LO Powers, RFIN = -20 dBm, IF = 1000 MHz, V<sub>DLNA</sub> = 3 V

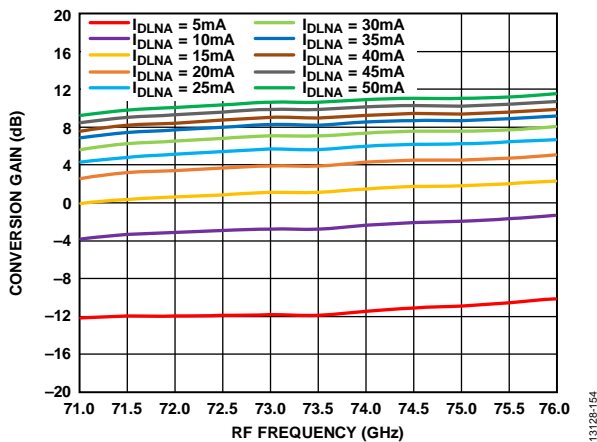

Figure 142. Conversion Gain vs. RF Frequency at Various I<sub>DLNA</sub> Values, RFIN = -20 dBm, IF = 1000 MHz, V<sub>DLNA</sub> = 4 V

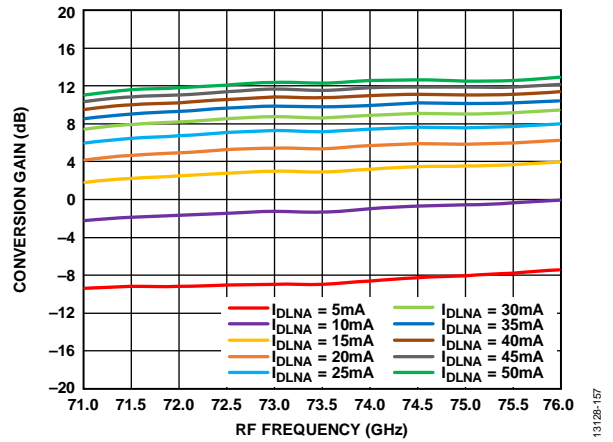

Figure 145. Conversion Gain vs. RF Frequency at Various I<sub>DLNA</sub> Values, RFIN = -20 dBm, IF = 1000 MHz, V<sub>DLNA</sub> = 3 V

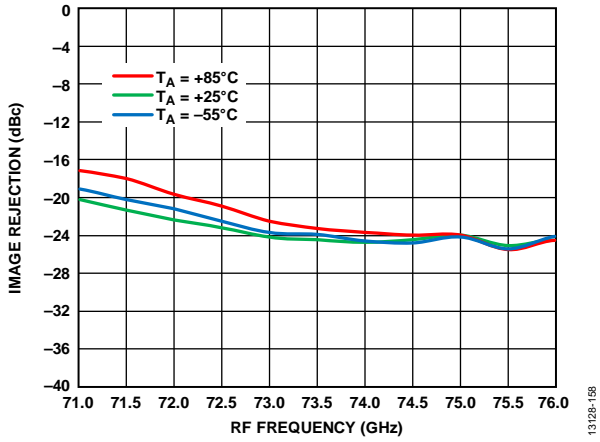

Figure 146. Image Rejection vs. RF Frequency at Various Temperatures,  $R_{FIN} = -20$  dBm,  $LO = 2$  dBm,  $IF = 1000$  MHz,  $V_{DLNA} = 4$  V

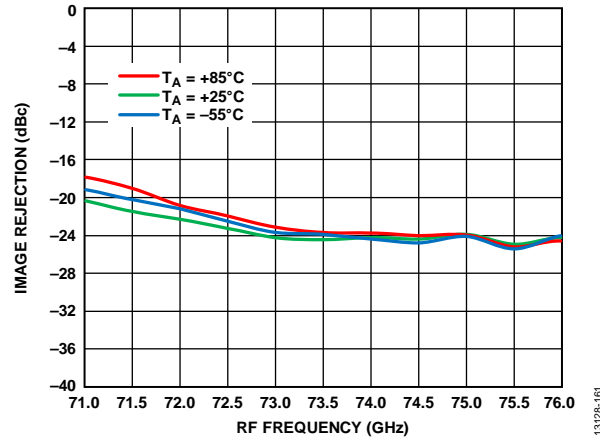

Figure 149. Image Rejection vs. RF Frequency at Various Temperatures,  $R_{FIN} = -20$  dBm,  $LO = 2$  dBm,  $IF = 1000$  MHz,  $V_{DLNA} = 3$  V

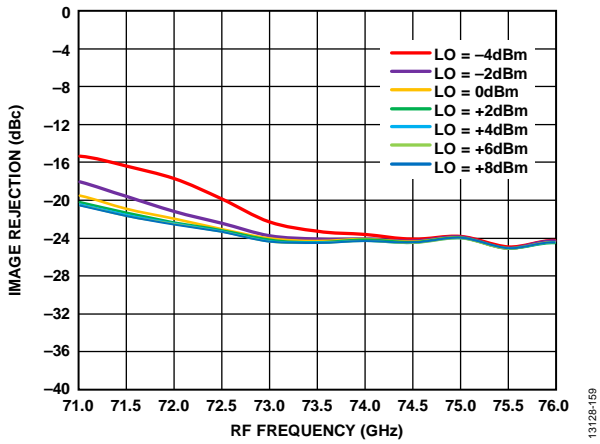

Figure 147. Image Rejection vs. RF Frequency at Various LO Powers,  $R_{FIN} = -20$  dBm,  $IF = 1000$  MHz,  $V_{DLNA} = 4$  V

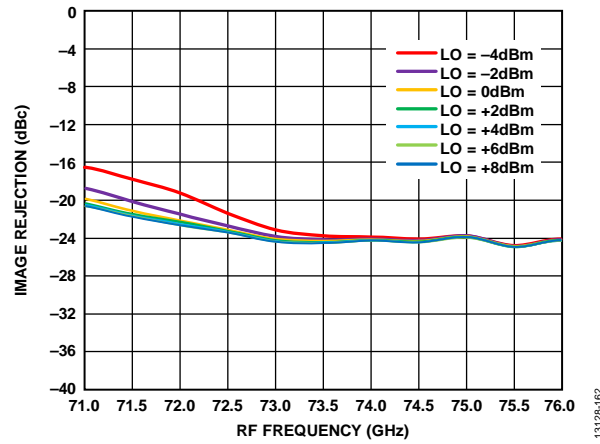

Figure 150. Image Rejection vs. RF Frequency at Various LO Powers,  $R_{FIN} = -20$  dBm,  $IF = 1000$  MHz,  $V_{DLNA} = 3$  V

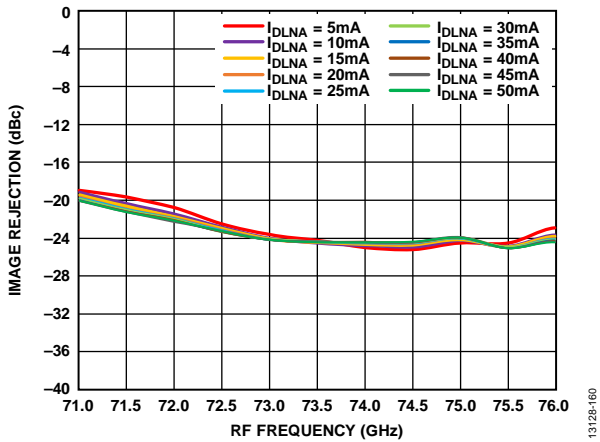

Figure 148. Image Rejection vs. RF Frequency at Various  $I_{DLNA}$  Values,  $R_{FIN} = -20$  dBm,  $LO = 2$  dBm,  $IF = 1000$  MHz,  $V_{DLNA} = 4$  V

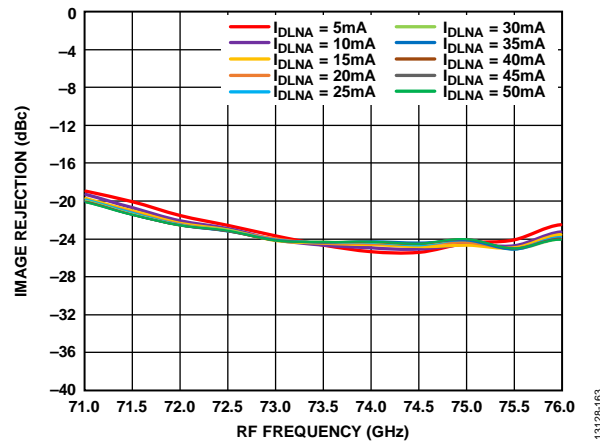

Figure 151. Image Rejection vs. RF Frequency at Various  $I_{DLNA}$  Values,  $R_{FIN} = -20$  dBm,  $LO = 2$  dBm,  $IF = 1000$  MHz,  $V_{DLNA} = 3$  V



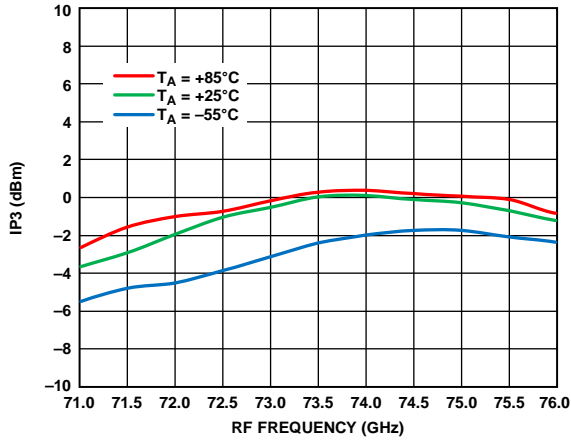

Figure 152. Input IP3 vs. RF Frequency at Various Temperatures,  $R_{FIN} = -20$  dBm, LO = 2 dBm, IF = 1000 MHz,  $V_{DLNA} = 4$  V

13128-164

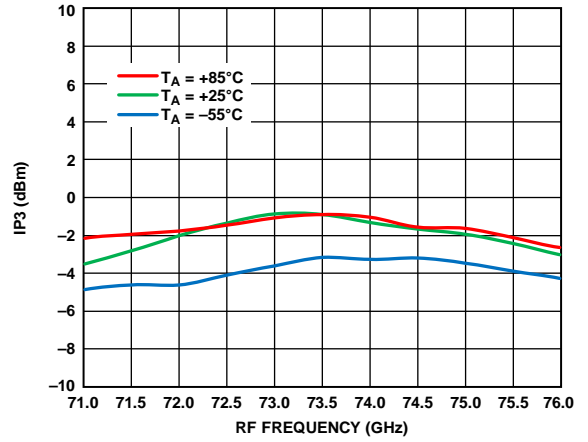

Figure 155. Input IP3 vs. RF Frequency at Various Temperatures,  $R_{FIN} = -20$  dBm, LO = 2 dBm, IF = 1000 MHz,  $V_{DLNA} = 3$  V

13128-167

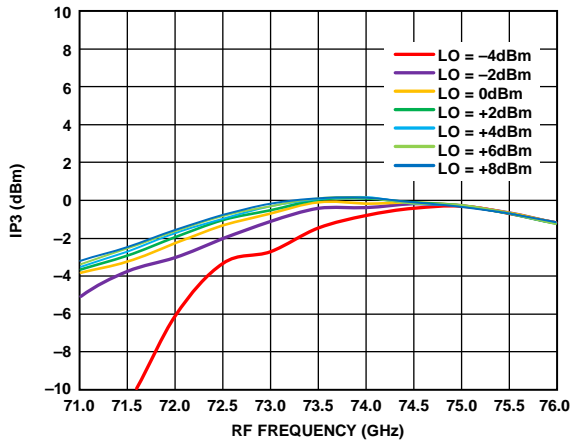

Figure 153. Input IP3 vs. RF Frequency at Various LO Powers,  $R_{FIN} = -20$  dBm, IF = 1000 MHz,  $V_{DLNA} = 4$  V

13128-165

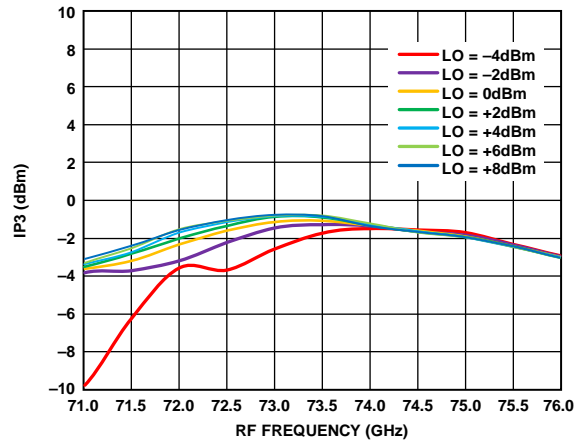

Figure 156. Input IP3 vs. RF Frequency at Various LO Powers,  $R_{FIN} = -20$  dBm, IF = 1000 MHz,  $V_{DLNA} = 3$  V

13128-168

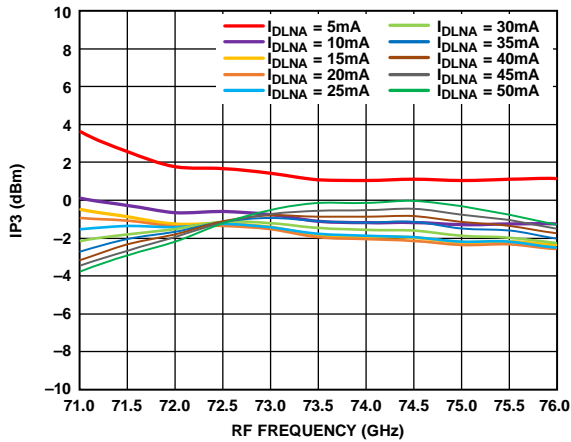

Figure 154. Input IP3 vs. RF Frequency at Various  $I_{DLNA}$  Values,  $R_{FIN} = -20$  dBm, LO = 2 dBm, IF = 1000 MHz,  $V_{DLNA} = 4$  V

13128-166

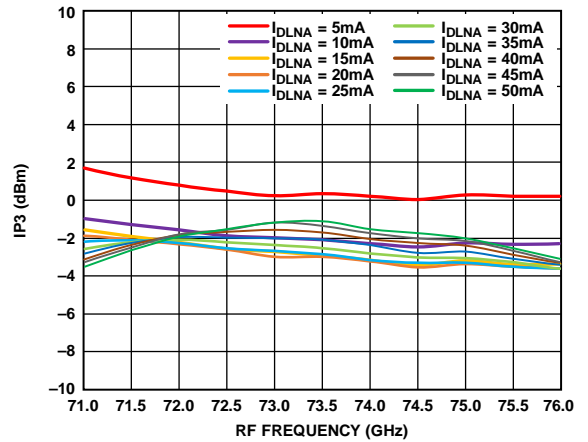
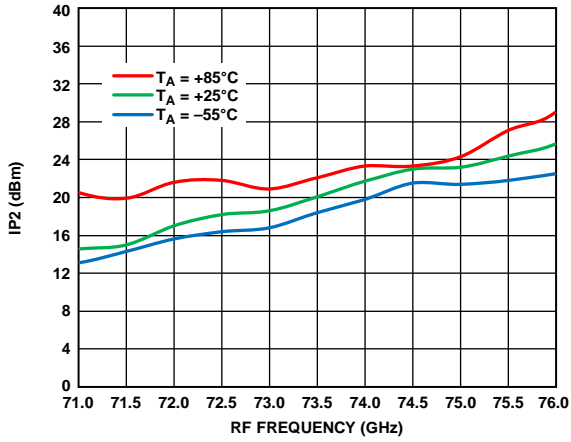

Figure 157. Input IP3 vs. RF Frequency at Various  $I_{DLNA}$  Values,  $R_{FIN} = -20$  dBm, LO = 2 dBm, IF = 1000 MHz,  $V_{DLNA} = 3$  V

13128-169



13128-170

Figure 158. Input IP2 vs. RF Frequency at Various Temperatures,  $RF_{IN} = -20$  dBm,  $LO = 2$  dBm,  $IF = 1000$  MHz,  $V_{DLNA} = 4$  V

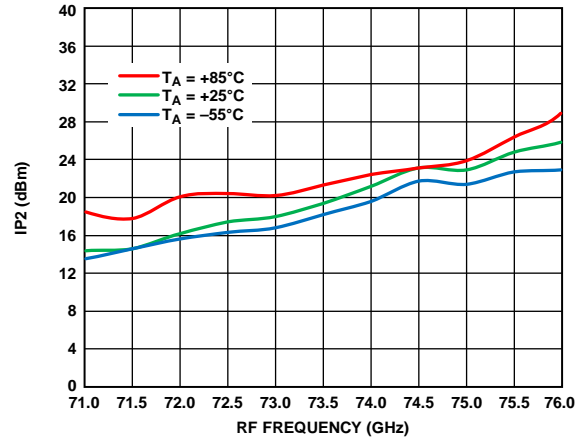

13128-173

Figure 161. Input IP2 vs. RF Frequency at Various Temperatures,  $RF_{IN} = -20$  dBm,  $LO = 2$  dBm,  $IF = 1000$  MHz,  $V_{DLNA} = 3$  V

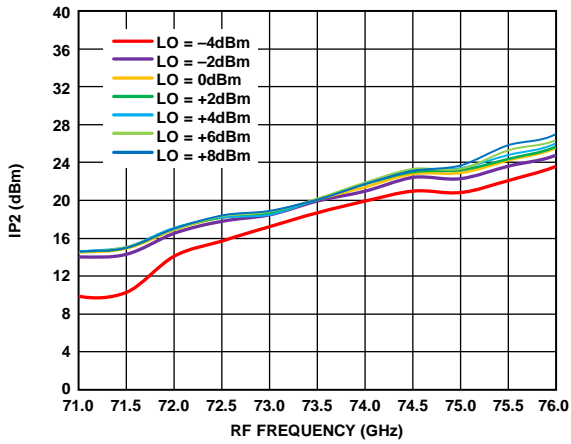

13128-171

Figure 159. Input IP2 vs. RF Frequency at Various LO Powers,  $RF_{IN} = -20$  dBm,  $IF = 1000$  MHz,  $V_{DLNA} = 4$  V

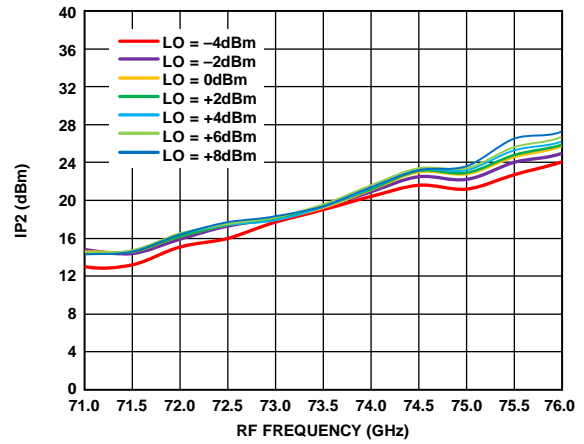

13128-174

Figure 162. Input IP2 vs. RF Frequency at Various LO Powers,  $RF_{IN} = -20$  dBm,  $IF = 1000$  MHz,  $V_{DLNA} = 3$  V

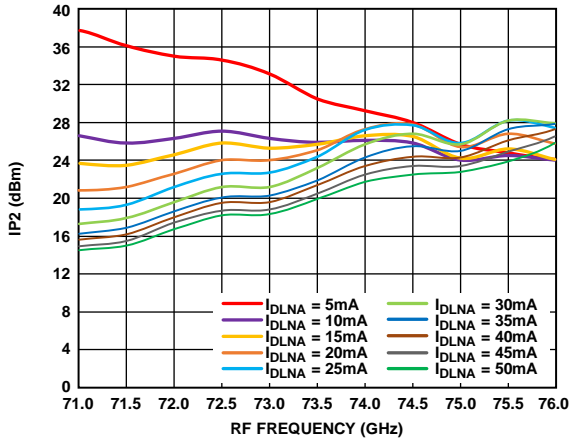

13128-172

Figure 160. Input IP2 vs. RF Frequency at Various  $I_{DLNA}$  Values,  $RF_{IN} = -20$  dBm,  $LO = 2$  dBm,  $IF = 1000$  MHz,  $V_{DLNA} = 4$  V

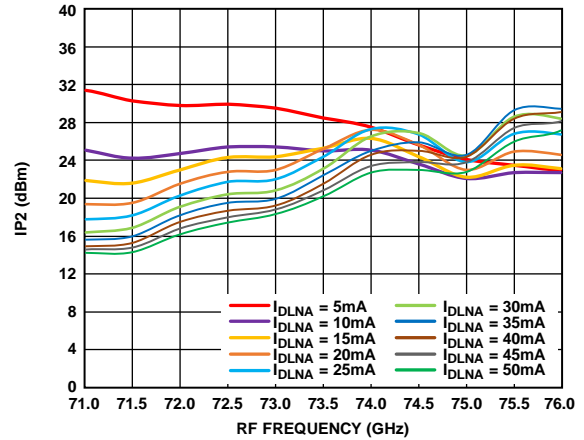

13128-175

Figure 163. Input IP2 vs. RF Frequency at Various  $I_{DLNA}$  Values,  $RF_{IN} = -20$  dBm,  $LO = 2$  dBm,  $IF = 1000$  MHz,  $V_{DLNA} = 3$  V

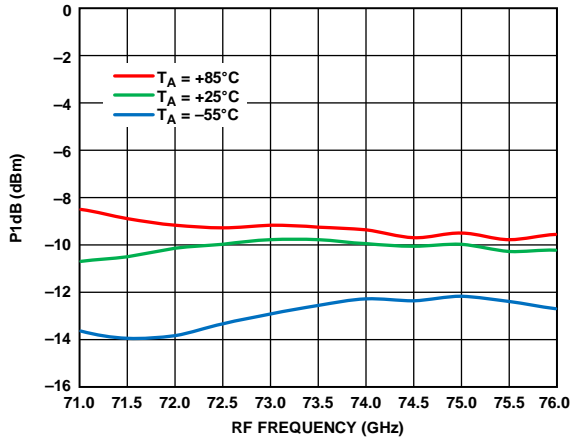

Figure 164. Input P1dB vs. RF Frequency at Various Temperatures, LO = 2 dBm, IF = 1000 MHz, V<sub>DLNA</sub> = 4 V

13128-176

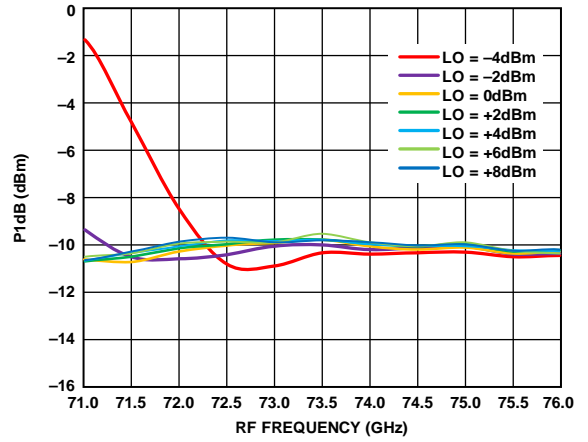
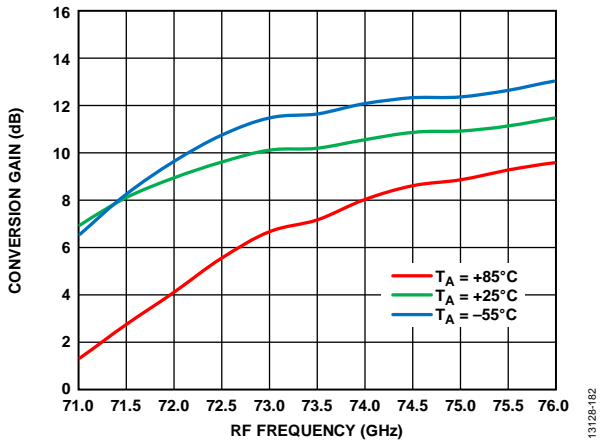

Figure 165. Input P1dB vs. RF Frequency at Various LO Powers, IF = 1000 MHz, V<sub>DLNA</sub> = 4 V

13128-178

UPPER SIDEBAND SELECTED, IF = 2000 MHz



13128-182

Figure 166. Conversion Gain vs. RF Frequency at Various Temperatures,  $R_{FIN} = -20$  dBm,  $LO = 2$  dBm,  $IF = 2000$  MHz,  $V_{DLNA} = 4$  V

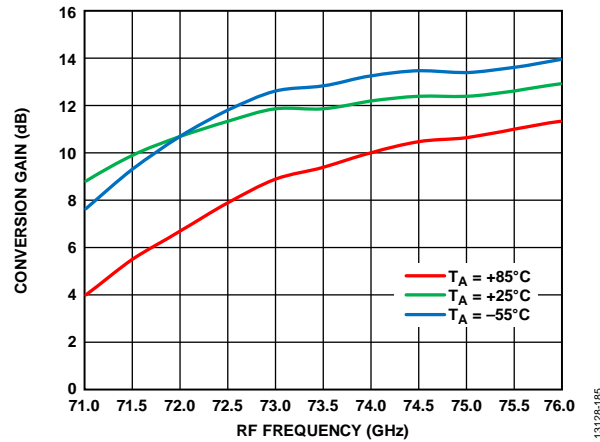

13128-185

Figure 169. Conversion Gain vs. RF Frequency at Various Temperatures,  $R_{FIN} = -20$  dBm,  $LO = 2$  dBm,  $IF = 2000$  MHz,  $V_{DLNA} = 3$  V

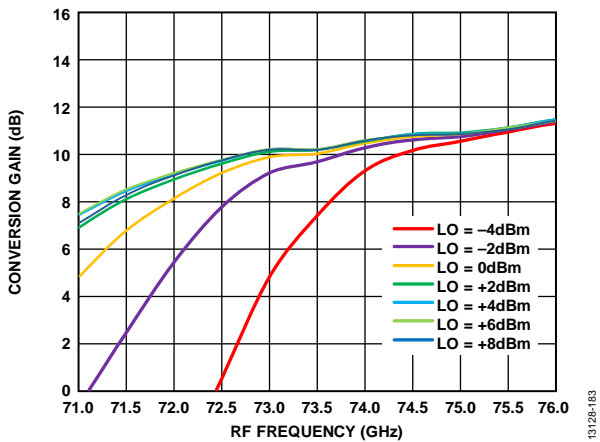

13128-183

Figure 167. Conversion Gain vs. RF Frequency at Various LO Powers,  $R_{FIN} = -20$  dBm,  $IF = 2000$  MHz,  $V_{DLNA} = 4$  V

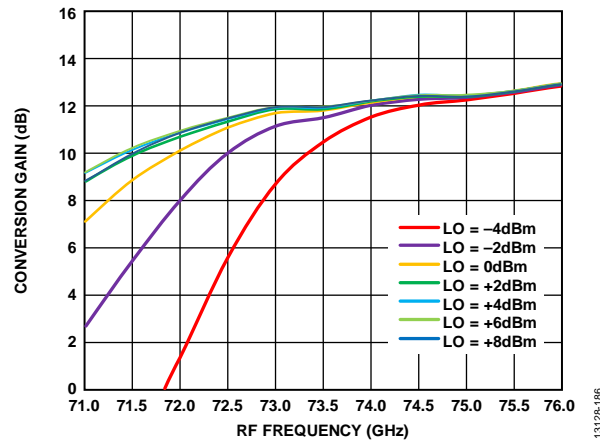

13128-186

Figure 170. Conversion Gain vs. RF Frequency at Various LO Powers,  $R_{FIN} = -20$  dBm,  $IF = 2000$  MHz,  $V_{DLNA} = 3$  V

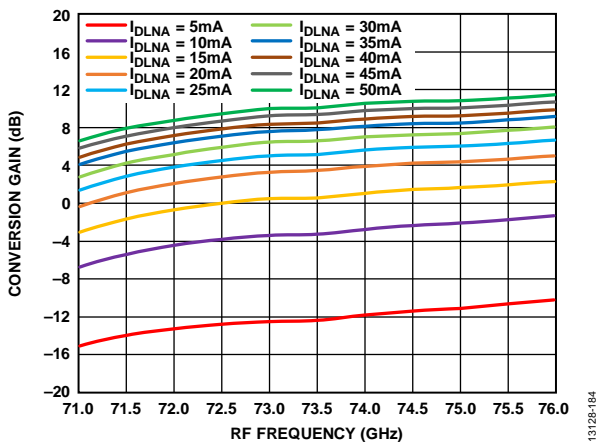

13128-184

Figure 168. Conversion Gain vs. RF Frequency at Various  $I_{DLNA}$  Values,  $R_{FIN} = -20$  dBm,  $IF = 2000$  MHz,  $V_{DLNA} = 4$  V

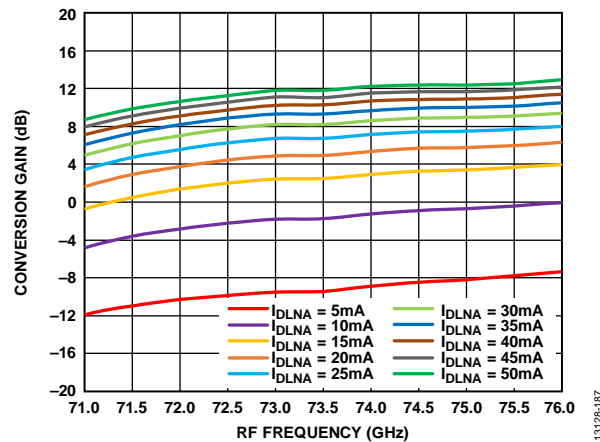

13128-187

Figure 171. Conversion Gain vs. RF Frequency at Various  $I_{DLNA}$  Values,  $R_{FIN} = -20$  dBm,  $IF = 2000$  MHz,  $V_{DLNA} = 3$  V

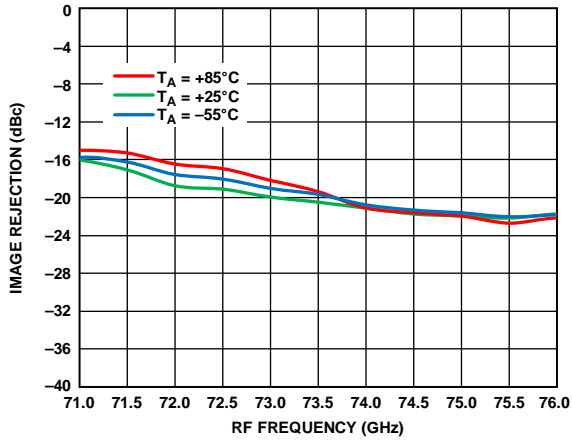

Figure 172. Image Rejection vs. RF Frequency at Various Temperatures,  $R_{FIN} = -20$  dBm,  $LO = 2$  dBm,  $IF = 2000$  MHz,  $V_{DLNA} = 4$  V

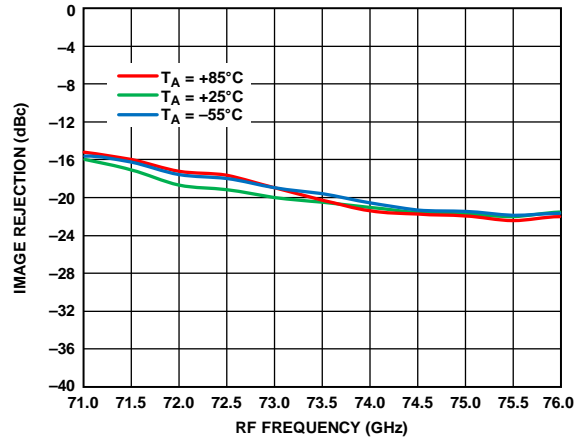

Figure 175. Image Rejection vs. RF Frequency at Various Temperatures,  $R_{FIN} = -20$  dBm,  $LO = 2$  dBm,  $IF = 2000$  MHz,  $V_{DLNA} = 3$  V

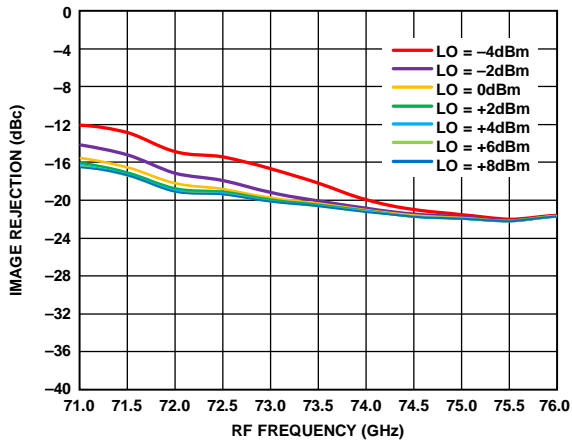

Figure 173. Image Rejection vs. RF Frequency at Various LO Powers,  $R_{FIN} = -20$  dBm,  $IF = 2000$  MHz,  $V_{DLNA} = 4$  V

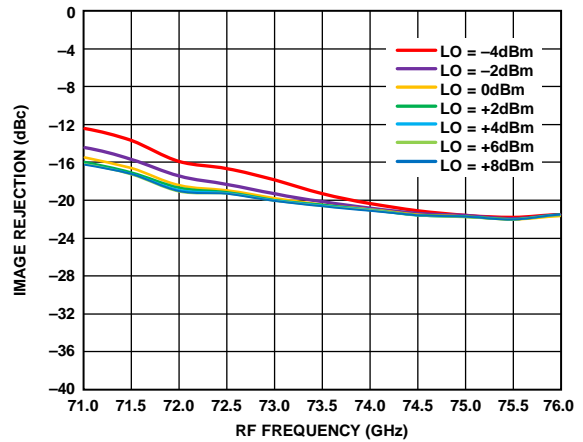

Figure 176. Image Rejection vs. RF Frequency at Various LO Powers,  $R_{FIN} = -20$  dBm,  $IF = 2000$  MHz,  $V_{DLNA} = 3$  V

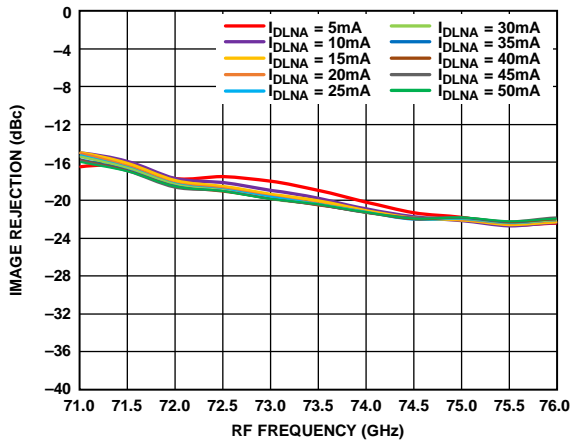

Figure 174. Image Rejection vs. RF Frequency at Various  $I_{DLNA}$  Values,  $R_{FIN} = -20$  dBm,  $LO = 2$  dBm,  $IF = 2000$  MHz,  $V_{DLNA} = 4$  V

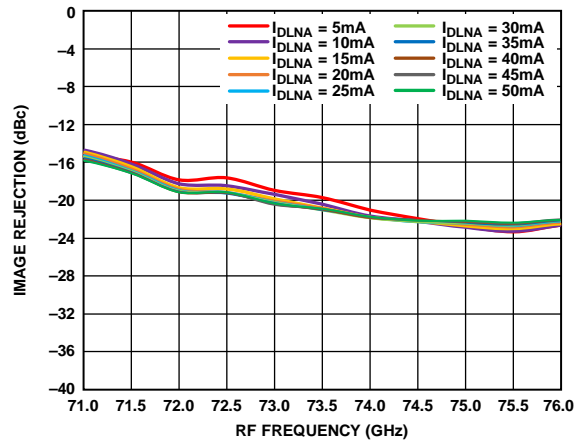
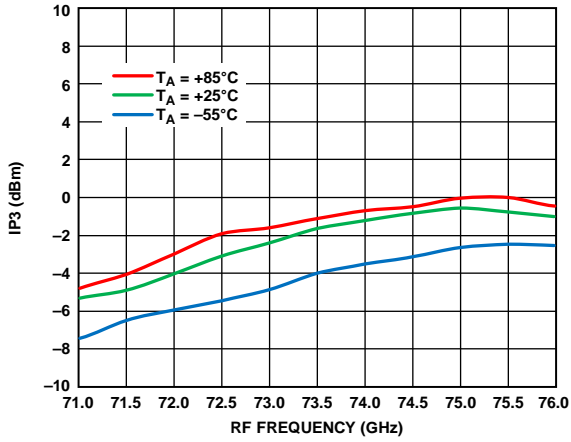
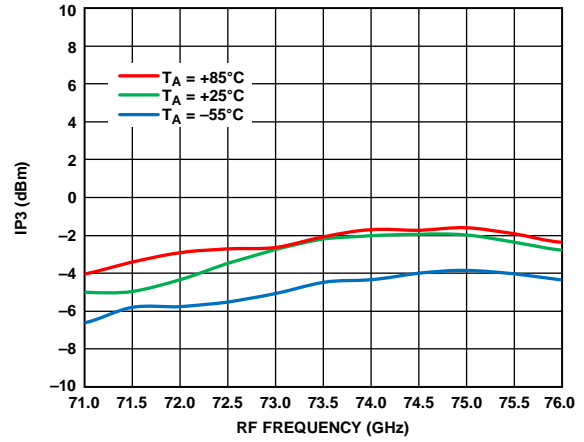

Figure 177. Image Rejection vs. RF Frequency at Various  $I_{DLNA}$  Values,  $R_{FIN} = -20$  dBm,  $LO = 2$  dBm,  $IF = 2000$  MHz,  $V_{DLNA} = 3$  V



13128-194

Figure 178. Input IP3 vs. RF Frequency at Various Temperatures,  $R_{FIN} = -20$  dBm,  $LO = 2$  dBm,  $IF = 2000$  MHz,  $V_{DLNA} = 4$  V



13128-197

Figure 181. Input IP3 vs. RF Frequency at Various Temperatures,  $R_{FIN} = -20$  dBm,  $LO = 2$  dBm,  $IF = 2000$  MHz,  $V_{DLNA} = 3$  V

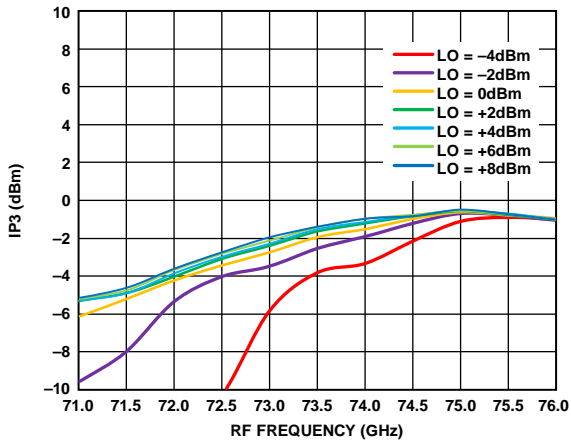

13128-195

Figure 179. Input IP3 vs. RF Frequency at Various LO Powers,  $R_{FIN} = -20$  dBm,  $IF = 2000$  MHz,  $V_{DLNA} = 4$  V

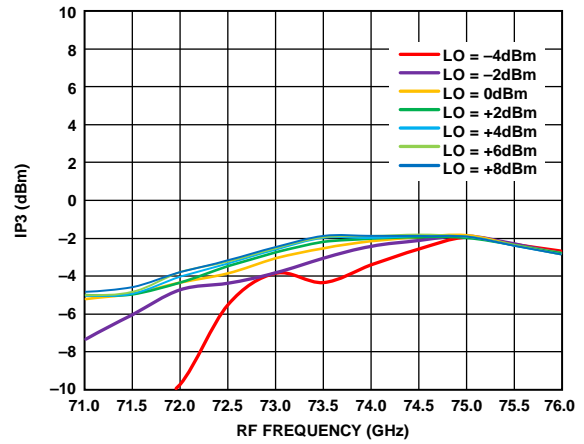

13128-198

Figure 182. Input IP3 vs. RF Frequency at Various LO Powers,  $R_{FIN} = -20$  dBm,  $IF = 2000$  MHz,  $V_{DLNA} = 3$  V

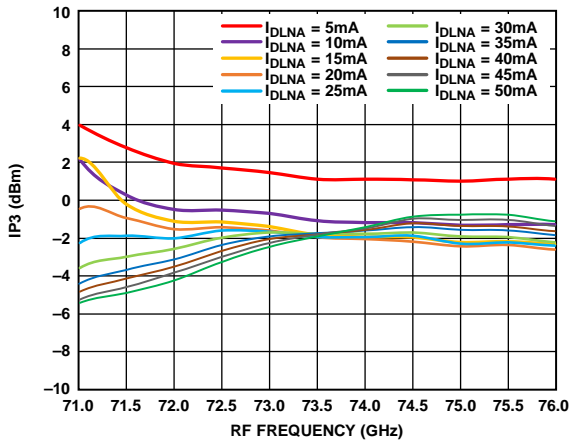

13128-196

Figure 180. Input IP3 vs. RF Frequency at Various  $I_{DLNA}$  Values,  $R_{FIN} = -20$  dBm,  $LO = 2$  dBm,  $IF = 2000$  MHz,  $V_{DLNA} = 4$  V

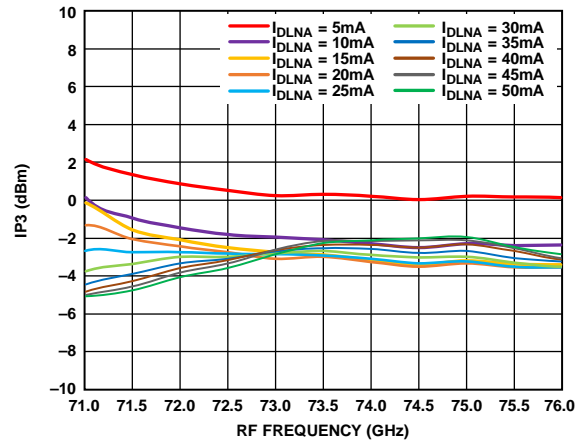

13128-199

Figure 183. Input IP3 vs. RF Frequency at Various  $I_{DLNA}$  Values,  $R_{FIN} = -20$  dBm,  $LO = 2$  dBm,  $IF = 2000$  MHz,  $V_{DLNA} = 3$  V

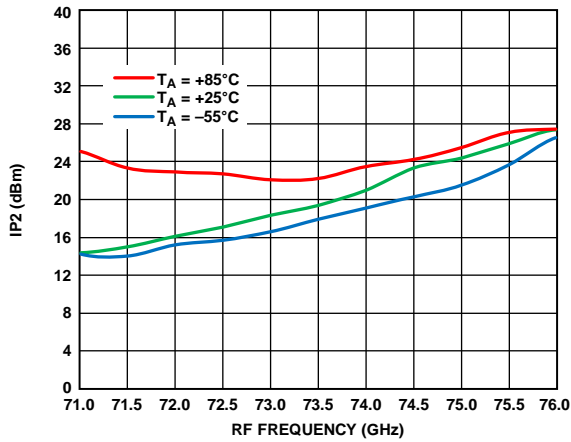

Figure 184. Input IP2 vs. RF Frequency at Various Temperatures,  $R_{FIN} = -20$  dBm,  $L_O = 2$  dBm,  $I_F = 2000$  MHz,  $V_{DLNA} = 4$  V

13128-200

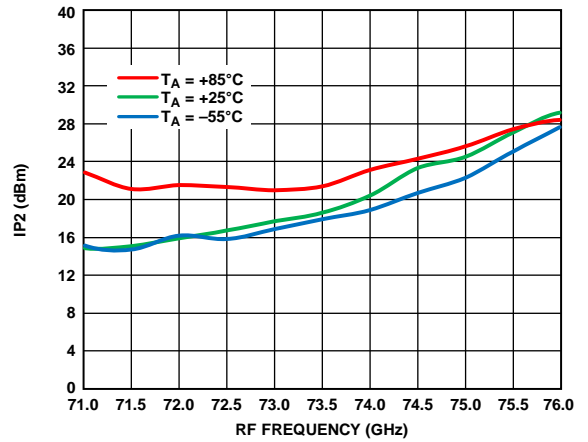

Figure 187. Input IP2 vs. RF Frequency at Various Temperatures,  $R_{FIN} = -20$  dBm,  $L_O = 2$  dBm,  $I_F = 2000$  MHz,  $V_{DLNA} = 3$  V

13128-203

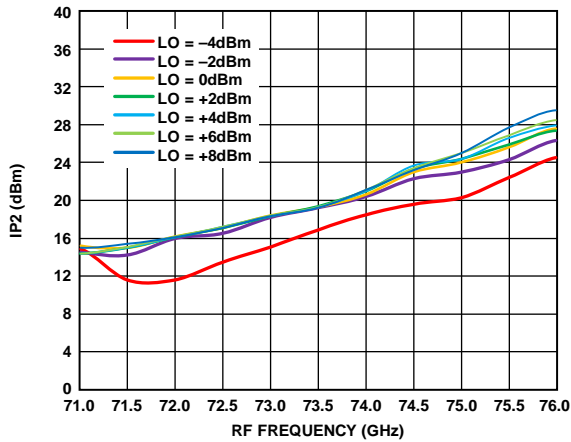

Figure 185. Input IP2 vs. RF Frequency at Various LO Powers,  $R_{FIN} = -20$  dBm,  $I_F = 2000$  MHz,  $V_{DLNA} = 4$  V

13128-201

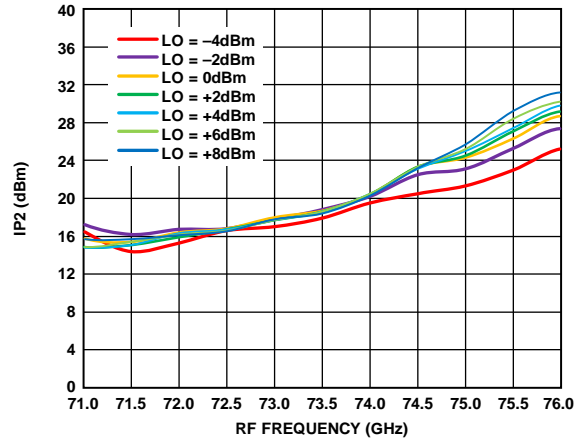

Figure 188. Input IP2 vs. RF Frequency at Various LO Powers,  $R_{FIN} = -20$  dBm,  $I_F = 2000$  MHz,  $V_{DLNA} = 3$  V

13128-204

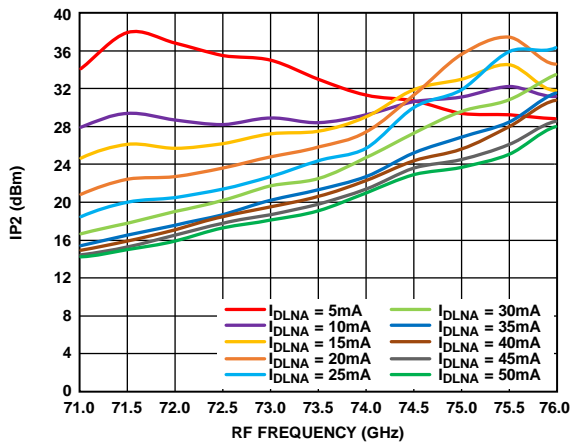

Figure 186. Input IP2 vs. RF Frequency at Various  $I_{DLNA}$  Values,  $R_{FIN} = -20$  dBm,  $L_O = 2$  dBm,  $I_F = 2000$  MHz,  $V_{DLNA} = 4$  V

13128-202

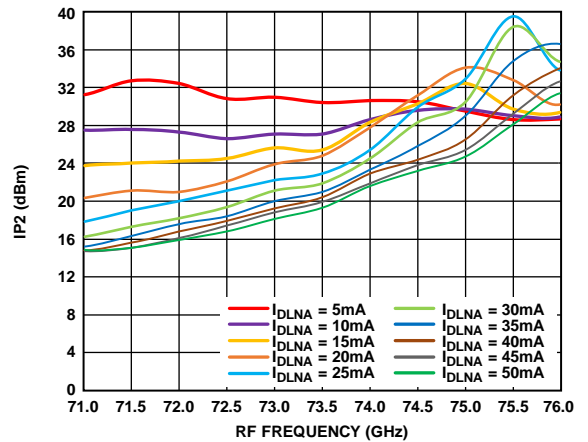

Figure 189. Input IP2 vs. RF Frequency at Various  $I_{DLNA}$  Values,  $R_{FIN} = -20$  dBm,  $L_O = 2$  dBm,  $I_F = 2000$  MHz,  $V_{DLNA} = 3$  V

13128-205

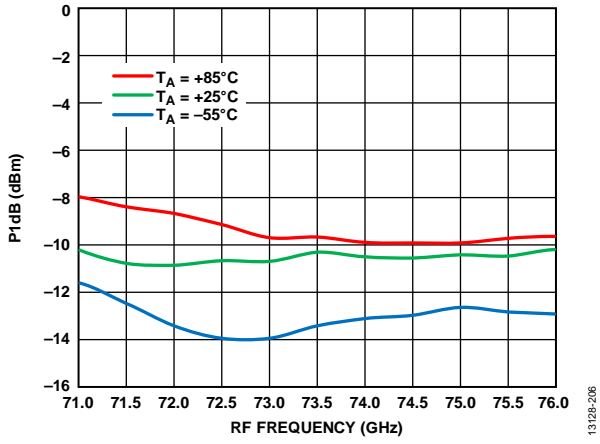

Figure 190. Input P1dB vs. RF Frequency at Various Temperatures, LO = 2 dBm, IF = 2000 MHz, V<sub>DLNA</sub> = 4 V

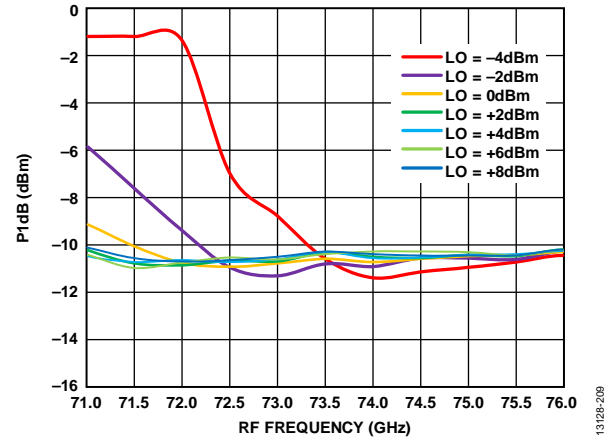

Figure 191. Input P1dB vs. RF Frequency at Various LO Powers, IF = 2000 MHz, V<sub>DLNA</sub> = 4 V

13128-206

13128-209



**NOISE FIGURE PERFORMANCE, UPPER SIDEBAND SELECTED**

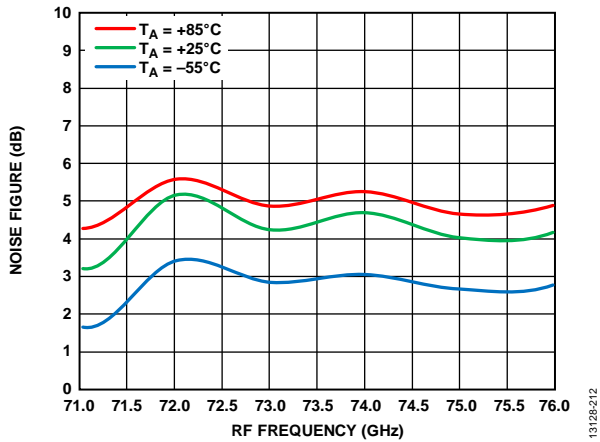

Figure 192. Noise Figure vs. RF Frequency at Various Temperatures, LO = 2 dBm, IF = 500 MHz,  $V_{DLNA} = 3 V$

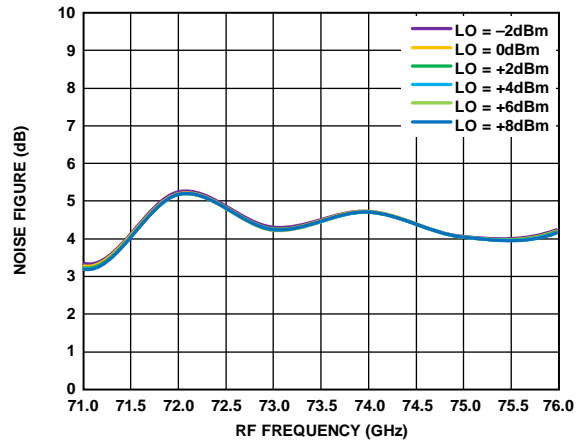

Figure 195. Noise Figure vs. RF Frequency at Various LO Powers, IF = 500 MHz,  $V_{DLNA} = 3 V$

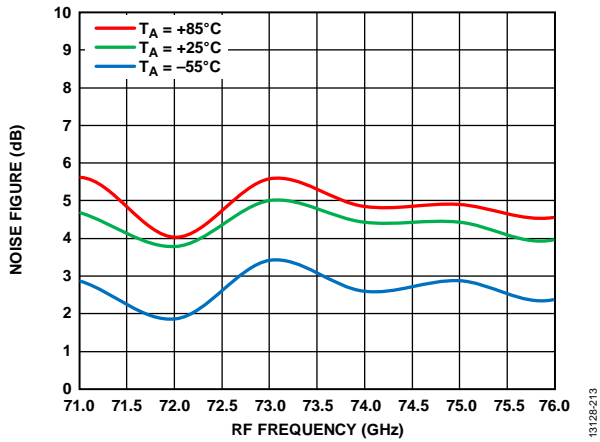

Figure 193. Noise Figure vs. RF Frequency at Various Temperatures, LO = 2 dBm, IF = 1000 MHz,  $V_{DLNA} = 3 V$

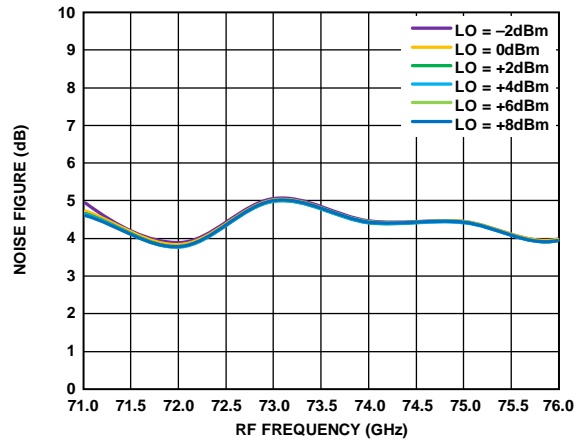

Figure 196. Noise Figure vs. RF Frequency at Various LO Powers, IF = 1000 MHz,  $V_{DLNA} = 3 V$

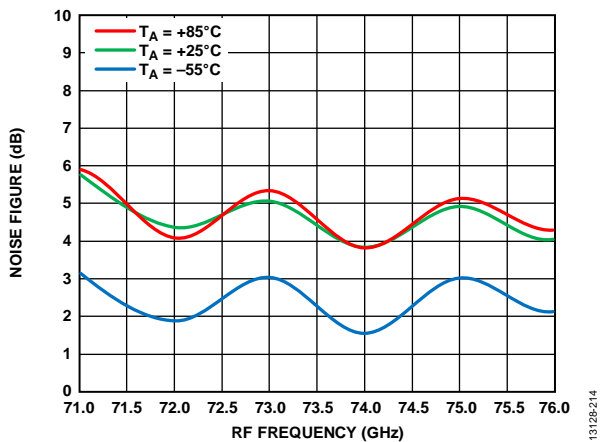

Figure 194. Noise Figure vs. RF Frequency at Various Temperatures, LO = 2 dBm, IF = 2000 MHz,  $V_{DLNA} = 3 V$

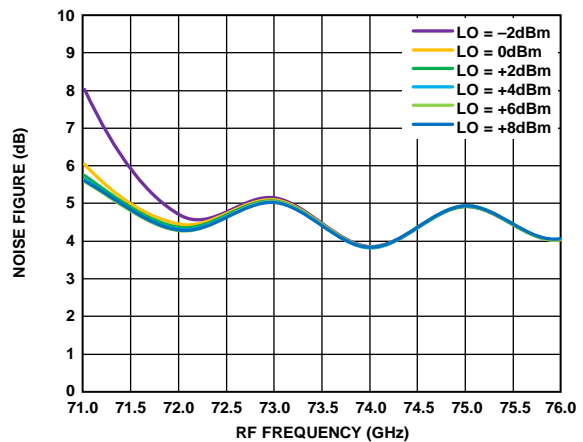

Figure 197. Noise Figure vs. RF Frequency at Various LO Powers, IF = 2000 MHz,  $V_{DLNA} = 3 V$

AMPLITUDE BALANCE PERFORMANCE, UPPER SIDEBAND SELECTED

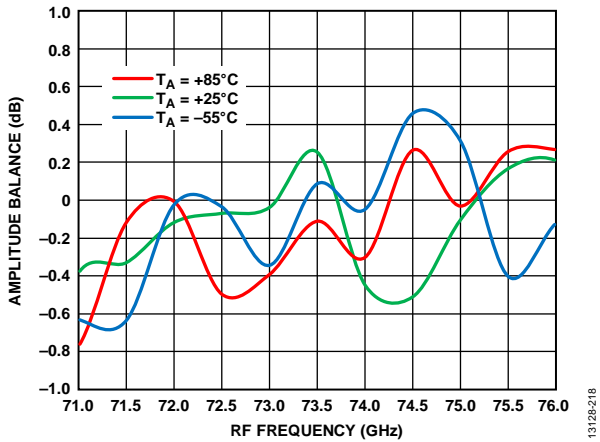

Figure 198. Amplitude Balance vs. RF Frequency at Various Temperatures, RFIN = -20 dBm, LO = 2 dBm, IF = 500 MHz, VDLNA = 4 V

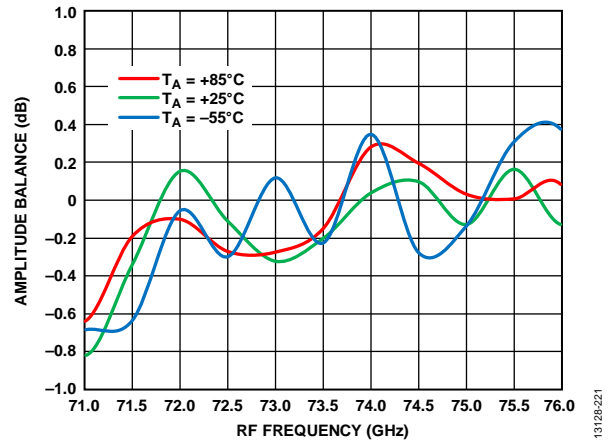

Figure 201. Amplitude Balance vs. RF Frequency at Various Temperatures, RFIN = -20 dBm, LO = 2 dBm, IF = 500 MHz, VDLNA = 3 V

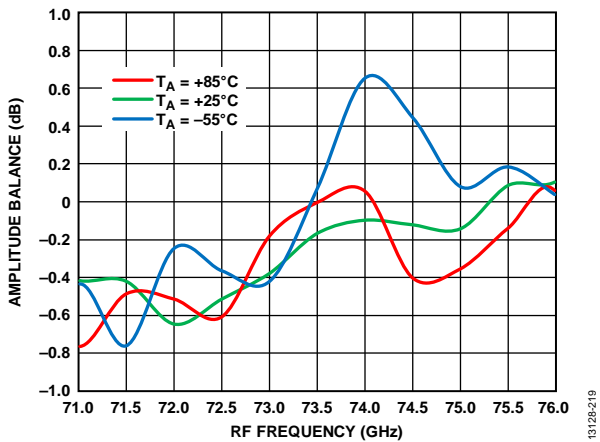

Figure 199. Amplitude Balance vs. RF Frequency at Various Temperatures, RFIN = -20 dBm, LO = 2 dBm, IF = 1000 MHz, VDLNA = 4 V

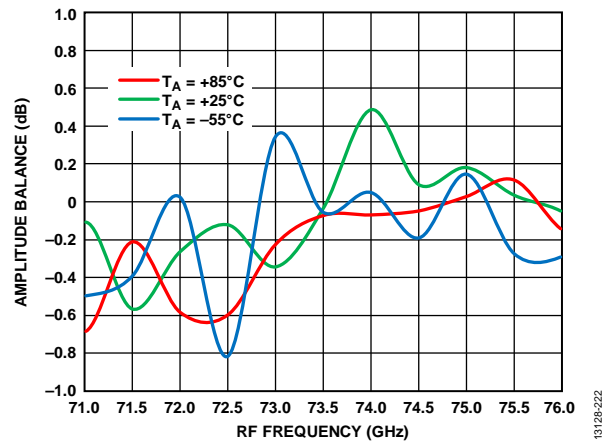

Figure 202. Amplitude Balance vs. RF Frequency at Various Temperatures, RFIN = -20 dBm, LO = 2 dBm, IF = 1000 MHz, VDLNA = 3 V

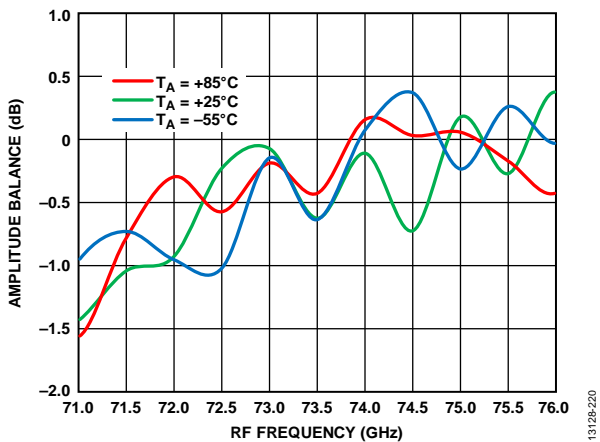

Figure 200. Amplitude Balance vs. RF Frequency at Various Temperatures, RFIN = -20 dBm, LO = 2 dBm, IF = 2000 MHz, VDLNA = 4 V

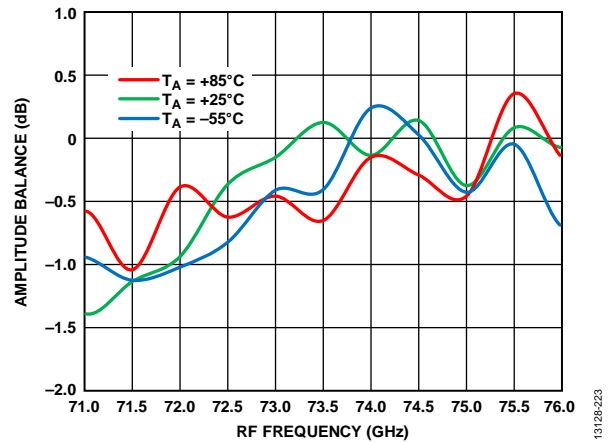

Figure 203. Amplitude Balance vs. RF Frequency at Various Temperatures, RFIN = -20 dBm, LO = 2 dBm, IF = 2000 MHz, VDLNA = 3 V

PHASE BALANCE PERFORMANCE, UPPER SIDEBAND SELECTED

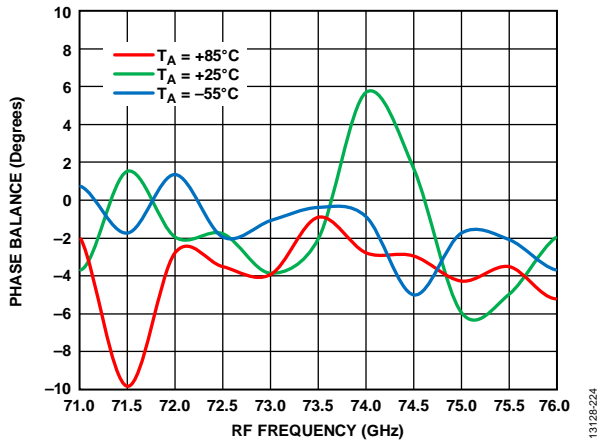

Figure 204. Phase Balance vs. RF Frequency at Various Temperatures, RFIN = -20 dBm, LO = 2 dBm, IF = 500 MHz, VDLNA = 4 V

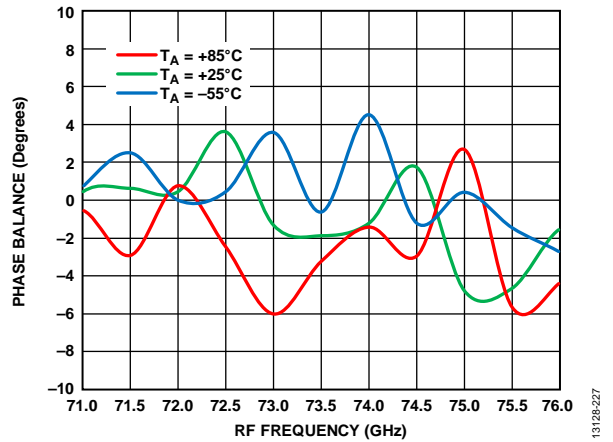

Figure 207. Phase Balance vs. RF Frequency at Various Temperatures, RFIN = -20 dBm, LO = 2 dBm, F = 500 MHz, VDLNA = 3 V

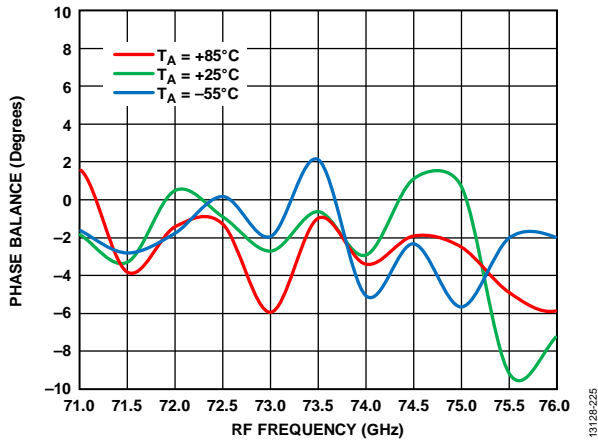

Figure 205. Phase Balance vs. RF Frequency at Various Temperatures, RFIN = -20 dBm, LO = 2 dBm, IF = 1000 MHz, VDLNA = 4 V

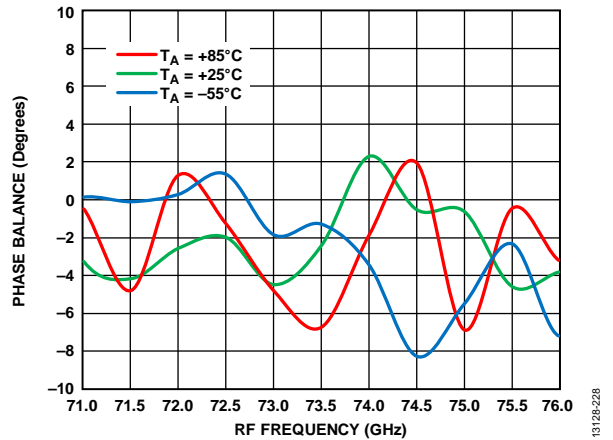

Figure 208. Phase Balance vs. RF Frequency at Various Temperatures, RFIN = -20 dBm, LO = 2 dBm, IF = 1000 MHz, VDLNA = 3 V

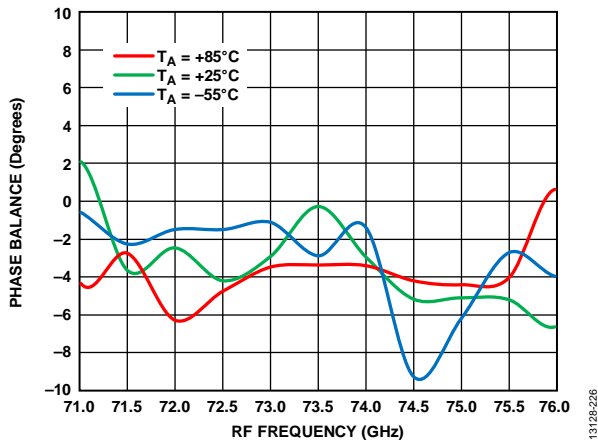

Figure 206. Phase Balance vs. RF Frequency at Various Temperatures, RFIN = -20 dBm, LO = 2 dBm, IF = 2000 MHz, VDLNA = 4 V

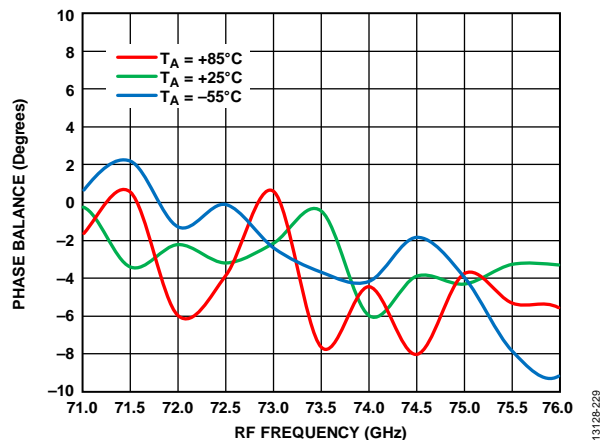

Figure 209. Phase Balance vs. RF Frequency at Various Temperatures, RFIN = -20 dBm, LO = 2 dBm, IF = 2000 MHz, VDLNA = 3 V

**SPURIOUS PERFORMANCE WITH LOWER SIDEBAND SELECTED, IF = 500 MHz**

$T_A = 25^\circ\text{C}$ ,  $V_{\text{GMIX}} = -1\text{ V}$ ,  $V_{\text{DAMPx}} = 4\text{ V}$ ,  $V_{\text{DMULT}} = 1.5\text{ V}$ ,  $\text{LOIN} = 2\text{ dBm}$ . Mixer spurious products are measured in dBc from the IF output power level. Spur values are  $(M \times \text{RF}) - (N \times \text{LO})$ . N/A means not applicable.

**$M \times N$  Spurious Outputs,  $V_{\text{DLNA}} = 4\text{ V}$**

RF = 71 GHz at  $\text{RFIN} = -10\text{ dBm}$ , LO frequency = 11.91 GHz at  $\text{LOIN} = 2\text{ dBm}$ .

		N × LO						
		0	1	2	3	4	5	6
M × RF	0	N/A	N/A	N/A	N/A	N/A	N/A	N/A
	1	N/A	N/A	N/A	N/A	N/A	N/A	N/A
	2	N/A	N/A	25.5	N/A	N/A	N/A	N/A
	3	N/A	N/A	N/A	34.8	N/A	N/A	N/A
	4	N/A	N/A	N/A	N/A	44.7	N/A	N/A
	5	N/A	N/A	N/A	N/A	N/A	48.9	N/A

RF = 73 GHz at  $\text{RFIN} = -10\text{ dBm}$ , LO frequency = 12.25 GHz at  $\text{LOIN} = 2\text{ dBm}$ .

		N × LO						
		0	1	2	3	4	5	6
M × RF	0	N/A	N/A	N/A	N/A	N/A	N/A	N/A
	1	N/A	N/A	N/A	N/A	N/A	N/A	N/A
	2	N/A	N/A	27	N/A	N/A	N/A	N/A
	3	N/A	N/A	N/A	37.6	N/A	N/A	N/A
	4	N/A	N/A	N/A	N/A	48.2	N/A	N/A
	5	N/A	N/A	N/A	N/A	N/A	53.9	N/A

RF = 76 GHz at  $\text{RFIN} = -10\text{ dBm}$ , LO frequency = 12.75 GHz at  $\text{LOIN} = 2\text{ dBm}$ .

		N × LO						
		0	1	2	3	4	5	6
M × RF	0	N/A	N/A	N/A	N/A	N/A	N/A	N/A
	1	N/A	N/A	N/A	N/A	N/A	N/A	N/A
	2	N/A	N/A	25.3	N/A	N/A	N/A	N/A
	3	N/A	N/A	N/A	37	N/A	N/A	N/A
	4	N/A	N/A	N/A	N/A	43.7	N/A	N/A
	5	N/A	N/A	N/A	N/A	N/A	56.5	N/A

**$M \times N$  Spurious Outputs,  $V_{\text{DLNA}} = 3\text{ V}$**

RF = 71 GHz at  $\text{RFIN} = -10\text{ dBm}$ , LO frequency = 11.91 GHz at  $\text{LOIN} = 2\text{ dBm}$ .

		N × LO						
		0	1	2	3	4	5	6
M × RF	0	N/A	N/A	N/A	N/A	N/A	N/A	N/A
	1	N/A	N/A	N/A	N/A	N/A	N/A	N/A
	2	N/A	N/A	25.7	N/A	N/A	N/A	N/A
	3	N/A	N/A	N/A	34.1	N/A	N/A	N/A
	4	N/A	N/A	N/A	N/A	44	N/A	N/A
	5	N/A	N/A	N/A	N/A	N/A	48.4	N/A

RF = 73 GHz at  $\text{RFIN} = -10\text{ dBm}$ , LO frequency = 12.25 MHz at  $\text{LOIN} = 2\text{ dBm}$ .

		N × LO						
		0	1	2	3	4	5	6
M × RF	0	N/A	N/A	N/A	N/A	N/A	N/A	N/A
	1	N/A	N/A	N/A	N/A	N/A	N/A	N/A
	2	N/A	N/A	27	N/A	N/A	N/A	N/A
	3	N/A	N/A	N/A	36.2	N/A	N/A	N/A
	4	N/A	N/A	N/A	N/A	45.9	N/A	N/A
	5	N/A	N/A	N/A	N/A	N/A	51.1	N/A

RF = 76 GHz at  $\text{RFIN} = -10\text{ dBm}$ , LO frequency = 12.75 GHz at  $\text{LOIN} = 2\text{ dBm}$ .

		N × LO						
		0	1	2	3	4	5	6
M × RF	0	N/A	N/A	N/A	N/A	N/A	N/A	N/A
	1	N/A	N/A	N/A	N/A	N/A	N/A	N/A
	2	N/A	N/A	25.3	N/A	N/A	N/A	N/A
	3	N/A	N/A	N/A	35.6	N/A	N/A	N/A
	4	N/A	N/A	N/A	N/A	42.5	N/A	N/A
	5	N/A	N/A	N/A	N/A	N/A	54.7	N/A

**SPURIOUS PERFORMANCE WITH LOWER SIDEBAND SELECTED, IF = 1000 MHz**

$T_A = 25^\circ\text{C}$ ,  $V_{\text{GMIX}} = -1\text{ V}$ ,  $V_{\text{DAMPx}} = 4\text{ V}$ ,  $V_{\text{DMULT}} = 1.5\text{ V}$ ,  $\text{LOIN} = 2\text{ dBm}$ . Mixer spurious products are measured in dBc from the IF output power level. Spur values are  $(M \times \text{RF}) - (N \times \text{LO})$ . N/A means not applicable.

**$M \times N$  Spurious Outputs,  $V_{\text{DLNA}} = 4\text{ V}$**

RF = 71 GHz at  $\text{RFIN} = -10\text{ dBm}$ , LO frequency = 12 GHz at  $\text{LOIN} = 2\text{ dBm}$ .

		N x LO						
		0	1	2	3	4	5	6
M x RF	0	N/A	N/A	N/A	N/A	N/A	N/A	N/A
	1	N/A	N/A	N/A	N/A	N/A	N/A	N/A
	2	N/A	N/A	26.6	N/A	N/A	N/A	N/A
	3	N/A	N/A	N/A	34.9	N/A	N/A	N/A
	4	N/A	N/A	N/A	N/A	44.8	N/A	N/A
	5	N/A	N/A	N/A	N/A	N/A	51.8	N/A

RF = 73 GHz at  $\text{RFIN} = -10\text{ dBm}$ , LO frequency = 12.33 MHz at  $\text{LOIN} = 2\text{ dBm}$ .

		N x LO						
		0	1	2	3	4	5	6
M x RF	0	N/A	N/A	N/A	N/A	N/A	N/A	N/A
	1	N/A	N/A	N/A	N/A	N/A	N/A	N/A
	2	N/A	N/A	27.8	N/A	N/A	N/A	N/A
	3	N/A	N/A	N/A	38.1	N/A	N/A	N/A
	4	N/A	N/A	N/A	N/A	47.7	N/A	N/A
	5	N/A	N/A	N/A	N/A	N/A	55.1	N/A

RF = 76 GHz at  $\text{RFIN} = -10\text{ dBm}$ , LO frequency = 12.83 GHz at  $\text{LOIN} = 2\text{ dBm}$ .

		N x LO						
		0	1	2	3	4	5	6
M x RF	0	N/A	N/A	N/A	N/A	N/A	N/A	N/A
	1	N/A	N/A	N/A	N/A	N/A	N/A	N/A
	2	N/A	N/A	26.2	N/A	N/A	N/A	N/A
	3	N/A	N/A	N/A	37.8	N/A	N/A	N/A
	4	N/A	N/A	N/A	N/A	46	N/A	N/A
	5	N/A	N/A	N/A	N/A	N/A	59.4	N/A

**$M \times N$  Spurious Outputs,  $V_{\text{DLNA}} = 3\text{ V}$**

RF = 71 GHz at  $\text{RFIN} = -10\text{ dBm}$ , LO frequency = 12 GHz at  $\text{LOIN} = 2\text{ dBm}$ .

		N x LO						
		0	1	2	3	4	5	6
M x RF	0	N/A	N/A	N/A	N/A	N/A	N/A	N/A
	1	N/A	N/A	N/A	N/A	N/A	N/A	N/A
	2	N/A	N/A	26.9	N/A	N/A	N/A	N/A
	3	N/A	N/A	N/A	33.9	N/A	N/A	N/A
	4	N/A	N/A	N/A	N/A	43.6	N/A	N/A
	5	N/A	N/A	N/A	N/A	N/A	50.5	N/A

RF = 73 GHz at  $\text{RFIN} = -10\text{ dBm}$ , LO frequency = 12.33 MHz at  $\text{LOIN} = 2\text{ dBm}$ .

		N x LO						
		0	1	2	3	4	5	6
M x RF	0	N/A	N/A	N/A	N/A	N/A	N/A	N/A
	1	N/A	N/A	N/A	N/A	N/A	N/A	N/A
	2	N/A	N/A	27.8	N/A	N/A	N/A	N/A
	3	N/A	N/A	N/A	36.6	N/A	N/A	N/A
	4	N/A	N/A	N/A	N/A	45.8	N/A	N/A
	5	N/A	N/A	N/A	N/A	N/A	53	N/A

RF = 76 GHz at  $\text{RFIN} = -10\text{ dBm}$ , LO frequency = 12.83 GHz at  $\text{LOIN} = 2\text{ dBm}$ .

		N x LO						
		0	1	2	3	4	5	6
M x RF	0	N/A	N/A	N/A	N/A	N/A	N/A	N/A
	1	N/A	N/A	N/A	N/A	N/A	N/A	N/A
	2	N/A	N/A	26.1	N/A	N/A	N/A	N/A
	3	N/A	N/A	N/A	36.2	N/A	N/A	N/A
	4	N/A	N/A	N/A	N/A	44.8	N/A	N/A
	5	N/A	N/A	N/A	N/A	N/A	56.7	N/A

**SPURIOUS PERFORMANCE WITH LOWER SIDEBAND SELECTED, IF = 2000 MHz**

$T_A = 25^\circ\text{C}$ ,  $V_{\text{GMIX}} = -1\text{ V}$ ,  $V_{\text{DAMPx}} = 4\text{ V}$ ,  $V_{\text{DMULT}} = 1.5\text{ V}$ ,  $\text{LOIN} = 2\text{ dBm}$ . Mixer spurious products are measured in dBc from the IF output power level. Spur values are  $(M \times \text{RF}) - (N \times \text{LO})$ . N/A means not applicable.

**$M \times N$  Spurious Outputs,  $V_{\text{DLNA}} = 4\text{ V}$**

RF = 71 GHz at  $\text{RFIN} = -10\text{ dBm}$ , LO frequency = 12.16 GHz at  $\text{LOIN} = 2\text{ dBm}$ .

		N × LO						
		0	1	2	3	4	5	6
M × RF	0	N/A	N/A	N/A	N/A	N/A	N/A	N/A
	1	N/A	N/A	N/A	N/A	N/A	N/A	N/A
	2	N/A	N/A	28	N/A	N/A	N/A	N/A
	3	N/A	N/A	N/A	39.7	N/A	N/A	N/A
	4	N/A	N/A	N/A	N/A	46.7	N/A	N/A
	5	N/A	N/A	N/A	N/A	N/A	56.7	N/A

RF = 73 GHz at  $\text{RFIN} = -10\text{ dBm}$ , LO frequency = 12.5 MHz at  $\text{LOIN} = 2\text{ dBm}$ .

		N × LO						
		0	1	2	3	4	5	6
M × RF	0	N/A	N/A	N/A	N/A	N/A	N/A	N/A
	1	N/A	N/A	N/A	N/A	N/A	N/A	N/A
	2	N/A	N/A	29.15	N/A	N/A	N/A	N/A
	3	N/A	N/A	N/A	40.7	N/A	N/A	N/A
	4	N/A	N/A	N/A	N/A	47.1	N/A	N/A
	5	N/A	N/A	N/A	N/A	N/A	57.5	N/A

RF = 76 GHz at  $\text{RFIN} = -10\text{ dBm}$ , LO frequency = 13 GHz at  $\text{LOIN} = 2\text{ dBm}$ .

		N × LO						
		0	1	2	3	4	5	6
M × RF	0	N/A	N/A	N/A	N/A	N/A	N/A	N/A
	1	N/A	N/A	N/A	N/A	N/A	N/A	N/A
	2	N/A	N/A	27.6	N/A	N/A	N/A	N/A
	3	N/A	N/A	N/A	40.6	N/A	N/A	N/A
	4	N/A	N/A	N/A	N/A	50.4	N/A	N/A
	5	N/A	N/A	N/A	N/A	N/A	63.4	N/A

**$M \times N$  Spurious Outputs,  $V_{\text{DLNA}} = 3\text{ V}$**

RF = 71 GHz at  $\text{RFIN} = -10\text{ dBm}$ , LO frequency = 12.16 GHz at  $\text{LOIN} = 2\text{ dBm}$ .

		N × LO						
		0	1	2	3	4	5	6
M × RF	0	N/A	N/A	N/A	N/A	N/A	N/A	N/A
	1	N/A	N/A	N/A	N/A	N/A	N/A	N/A
	2	N/A	N/A	28	N/A	N/A	N/A	N/A
	3	N/A	N/A	N/A	37.3	N/A	N/A	N/A
	4	N/A	N/A	N/A	N/A	44.1	N/A	N/A
	5	N/A	N/A	N/A	N/A	N/A	54.4	N/A

RF = 73 GHz at  $\text{RFIN} = -10\text{ dBm}$ , LO frequency = 12.5 MHz at  $\text{LOIN} = 2\text{ dBm}$ .

		N × LO						
		0	1	2	3	4	5	6
M × RF	0	N/A	N/A	N/A	N/A	N/A	N/A	N/A
	1	N/A	N/A	N/A	N/A	N/A	N/A	N/A
	2	N/A	N/A	29.5	N/A	N/A	N/A	N/A
	3	N/A	N/A	N/A	38.5	N/A	N/A	N/A
	4	N/A	N/A	N/A	N/A	45.3	N/A	N/A
	5	N/A	N/A	N/A	N/A	N/A	55.5	N/A

RF = 76 GHz at  $\text{RFIN} = -10\text{ dBm}$ , LO frequency = 13 GHz at  $\text{LOIN} = 2\text{ dBm}$ .

		N × LO						
		0	1	2	3	4	5	6
M × RF	0	N/A	N/A	N/A	N/A	N/A	N/A	N/A
	1	N/A	N/A	N/A	N/A	N/A	N/A	N/A
	2	N/A	N/A	27.1	N/A	N/A	N/A	N/A
	3	N/A	N/A	N/A	38.8	N/A	N/A	N/A
	4	N/A	N/A	N/A	N/A	48.8	N/A	N/A
	5	N/A	N/A	N/A	N/A	N/A	61	N/A

**SPURIOUS PERFORMANCE WITH UPPER SIDEBAND SELECTED, IF = 500 MHz**

$T_A = 25^\circ\text{C}$ ,  $V_{\text{GMIX}} = -1\text{ V}$ ,  $V_{\text{DAMPx}} = 4\text{ V}$ ,  $V_{\text{DMULT}} = 1.5\text{ V}$ ,  $\text{LOIN} = 2\text{ dBm}$ . Mixer spurious products are measured in dBc from the IF output power level. Spur values are  $(M \times \text{RF}) - (N \times \text{LO})$ .

N/A means not applicable.

**$M \times N$  Spurious Outputs,  $V_{\text{DLNA}} = 4\text{ V}$**

RF = 71 GHz at  $\text{RFIN} = -10\text{ dBm}$ , LO frequency = 11.75 GHz at  $\text{LOIN} = 2\text{ dBm}$ .

		N x LO						
		0	1	2	3	4	5	6
M x RF	0	N/A	N/A	N/A	N/A	N/A	N/A	N/A
	1	N/A	N/A	N/A	N/A	N/A	N/A	N/A
	2	N/A	N/A	24.8	N/A	N/A	N/A	N/A
	3	N/A	N/A	N/A	36	N/A	N/A	N/A
	4	N/A	N/A	N/A	N/A	46.7	N/A	N/A
	5	N/A	N/A	N/A	N/A	N/A	49.4	N/A

RF = 73 GHz at  $\text{RFIN} = -10\text{ dBm}$ , LO frequency = 12.08 GHz at  $\text{LOIN} = 2\text{ dBm}$ .

		N x LO						
		0	1	2	3	4	5	6
M x RF	0	N/A	N/A	N/A	N/A	N/A	N/A	N/A
	1	N/A	N/A	N/A	N/A	N/A	N/A	N/A
	2	N/A	N/A	25.8	N/A	N/A	N/A	N/A
	3	N/A	N/A	N/A	35.6	N/A	N/A	N/A
	4	N/A	N/A	N/A	N/A	46.4	N/A	N/A
	5	N/A	N/A	N/A	N/A	N/A	51.3	N/A

RF = 76 GHz at  $\text{RFIN} = -10\text{ dBm}$ , LO frequency = 12.58 GHz at  $\text{LOIN} = 2\text{ dBm}$ .

		N x LO						
		0	1	2	3	4	5	6
M x RF	0	N/A	N/A	N/A	N/A	N/A	N/A	N/A
	1	N/A	N/A	N/A	N/A	N/A	N/A	N/A
	2	N/A	N/A	24.2	N/A	N/A	N/A	N/A
	3	N/A	N/A	N/A	36.5	N/A	N/A	N/A
	4	N/A	N/A	N/A	N/A	44.5	N/A	N/A
	5	N/A	N/A	N/A	N/A	N/A	55.6	N/A

**$M \times N$  Spurious Outputs,  $V_{\text{DLNA}} = 3\text{ V}$**

RF = 71 GHz at  $\text{RFIN} = -10\text{ dBm}$ , LO frequency = 11.75 GHz at  $\text{LOIN} = 2\text{ dBm}$ .

		N x LO						
		0	1	2	3	4	5	6
M x RF	0	N/A	N/A	N/A	N/A	N/A	N/A	N/A
	1	N/A	N/A	N/A	N/A	N/A	N/A	N/A
	2	N/A	N/A	24.4	N/A	N/A	N/A	N/A
	3	N/A	N/A	N/A	35.2	N/A	N/A	N/A
	4	N/A	N/A	N/A	N/A	45.6	N/A	N/A
	5	N/A	N/A	N/A	N/A	N/A	53	N/A

RF = 73 GHz at  $\text{RFIN} = -10\text{ dBm}$ , LO frequency = 12.08 MHz at  $\text{LOIN} = 2\text{ dBm}$ .

		N x LO						
		0	1	2	3	4	5	6
M x RF	0	N/A	N/A	N/A	N/A	N/A	N/A	N/A
	1	N/A	N/A	N/A	N/A	N/A	N/A	N/A
	2	N/A	N/A	25.5	N/A	N/A	N/A	N/A
	3	N/A	N/A	N/A	34.1	N/A	N/A	N/A
	4	N/A	N/A	N/A	N/A	44.5	N/A	N/A
	5	N/A	N/A	N/A	N/A	N/A	48.7	N/A

RF = 76 GHz at  $\text{RFIN} = -10\text{ dBm}$ , LO frequency = 12.58 GHz at  $\text{LOIN} = 2\text{ dBm}$ .

		N x LO						
		0	1	2	3	4	5	6
M x RF	0	N/A	N/A	N/A	N/A	N/A	N/A	N/A
	1	N/A	N/A	N/A	N/A	N/A	N/A	N/A
	2	N/A	N/A	24	N/A	N/A	N/A	N/A
	3	N/A	N/A	N/A	34.9	N/A	N/A	N/A
	4	N/A	N/A	N/A	N/A	44	N/A	N/A
	5	N/A	N/A	N/A	N/A	N/A	53.3	N/A

**SPURIOUS PERFORMANCE WITH UPPER SIDEBAND SELECTED, IF = 1000 MHz**

$T_A = 25^\circ\text{C}$ ,  $V_{\text{GMIX}} = -1\text{ V}$ ,  $V_{\text{DAMPx}} = 4\text{ V}$ ,  $V_{\text{DMULT}} = 1.5\text{ V}$ ,  $\text{LOIN} = 2\text{ dBm}$ . Mixer spurious products are measured in dBc from the IF output power level. Spur values are  $(M \times \text{RF}) - (N \times \text{LO})$ . N/A means not applicable.

**$M \times N$  Spurious Outputs,  $V_{\text{DLNA}} = 4\text{ V}$**

RF = 71 GHz at  $\text{RFIN} = -10\text{ dBm}$ , LO frequency = 11.66 GHz at  $\text{LOIN} = 2\text{ dBm}$ .

		N x LO						
		0	1	2	3	4	5	6
M x RF	0	N/A	N/A	N/A	N/A	N/A	N/A	N/A
	1	N/A	N/A	N/A	N/A	N/A	N/A	N/A
	2	N/A	N/A	25.2	N/A	N/A	N/A	N/A
	3	N/A	N/A	N/A	37.4	N/A	N/A	N/A
	4	N/A	N/A	N/A	N/A	50.2	N/A	N/A
	5	N/A	N/A	N/A	N/A	N/A	50.8	N/A

RF = 73 GHz at  $\text{RFIN} = -10\text{ dBm}$ , LO frequency = 12 GHz at  $\text{LOIN} = 2\text{ dBm}$ .

		N x LO						
		0	1	2	3	4	5	6
M x RF	0	N/A	N/A	N/A	N/A	N/A	N/A	N/A
	1	N/A	N/A	N/A	N/A	N/A	N/A	N/A
	2	N/A	N/A	25.6	N/A	N/A	N/A	N/A
	3	N/A	N/A	N/A	34.4	N/A	N/A	N/A
	4	N/A	N/A	N/A	N/A	46	N/A	N/A
	5	N/A	N/A	N/A	N/A	N/A	49.5	N/A

RF = 76 GHz at  $\text{RFIN} = -10\text{ dBm}$ , LO frequency = 12.5 GHz at  $\text{LOIN} = 2\text{ dBm}$ .

		N x LO						
		0	1	2	3	4	5	6
M x RF	0	N/A	N/A	N/A	N/A	N/A	N/A	N/A
	1	N/A	N/A	N/A	N/A	N/A	N/A	N/A
	2	N/A	N/A	24.8	N/A	N/A	N/A	N/A
	3	N/A	N/A	N/A	36.5	N/A	N/A	N/A
	4	N/A	N/A	N/A	N/A	46.1	N/A	N/A
	5	N/A	N/A	N/A	N/A	N/A	55.2	N/A

**$M \times N$  Spurious Outputs,  $V_{\text{DLNA}} = 3\text{ V}$**

RF = 71 GHz at  $\text{RFIN} = -10\text{ dBm}$ , LO frequency = 11.66 GHz at  $\text{LOIN} = 2\text{ dBm}$ .

		N x LO						
		0	1	2	3	4	5	6
M x RF	0	N/A	N/A	N/A	N/A	N/A	N/A	N/A
	1	N/A	N/A	N/A	N/A	N/A	N/A	N/A
	2	N/A	N/A	24.6	N/A	N/A	N/A	N/A
	3	N/A	N/A	N/A	37.1	N/A	N/A	N/A
	4	N/A	N/A	N/A	N/A	47.6	N/A	N/A
	5	N/A	N/A	N/A	N/A	N/A	57.7	N/A

RF = 73 GHz at  $\text{RFIN} = -10\text{ dBm}$ , LO frequency = 12 GHz at  $\text{LOIN} = 2\text{ dBm}$ .

		N x LO						
		0	1	2	3	4	5	6
M x RF	0	N/A	N/A	N/A	N/A	N/A	N/A	N/A
	1	N/A	N/A	N/A	N/A	N/A	N/A	N/A
	2	N/A	N/A	25.3	N/A	N/A	N/A	N/A
	3	N/A	N/A	N/A	33.2	N/A	N/A	N/A
	4	N/A	N/A	N/A	N/A	44.2	N/A	N/A
	5	N/A	N/A	N/A	N/A	N/A	47.6	N/A

RF = 76 GHz at  $\text{RFIN} = -10\text{ dBm}$ , LO frequency = 12.5 GHz at  $\text{LOIN} = 2\text{ dBm}$ .

		N x LO						
		0	1	2	3	4	5	6
M x RF	0	N/A	N/A	N/A	N/A	N/A	N/A	N/A
	1	N/A	N/A	N/A	N/A	N/A	N/A	N/A
	2	N/A	N/A	24.6	N/A	N/A	N/A	N/A
	3	N/A	N/A	N/A	34.7	N/A	N/A	N/A
	4	N/A	N/A	N/A	N/A	44.4	N/A	N/A
	5	N/A	N/A	N/A	N/A	N/A	52.9	N/A



**SPURIOUS PERFORMANCE WITH UPPER SIDEBAND SELECTED, IF = 2000 MHz**

$T_A = 25^\circ\text{C}$ ,  $V_{\text{GMIX}} = -1\text{ V}$ ,  $V_{\text{DAMPx}} = 4\text{ V}$ ,  $V_{\text{DMULT}} = 1.5\text{ V}$ ,  $\text{LOIN} = 2\text{ dBm}$ . Mixer spurious products are measured in dBc from the IF output power level. Spur values are  $(M \times \text{RF}) - (N \times \text{LO})$ .

N/A means not applicable.

**$M \times N$  Spurious Outputs,  $V_{\text{DLNA}} = 4\text{ V}$**

RF = 71 GHz at  $\text{RFIN} = -10\text{ dBm}$ , LO frequency = 11.5 GHz at  $\text{LOIN} = 2\text{ dBm}$ .

		N × LO						
		0	1	2	3	4	5	6
M × RF	0	N/A	N/A	N/A	N/A	N/A	N/A	N/A
	1	N/A	N/A	N/A	N/A	N/A	N/A	N/A
	2	N/A	N/A	25.6	N/A	N/A	N/A	N/A
	3	N/A	N/A	N/A	41.2	N/A	N/A	N/A
	4	N/A	N/A	N/A	N/A	49.5	N/A	N/A
	5	N/A	N/A	N/A	N/A	N/A	59.4	N/A

RF = 73 GHz at  $\text{RFIN} = -10\text{ dBm}$ , LO frequency = 11.83 GHz at  $\text{LOIN} = 2\text{ dBm}$ .

		N × LO						
		0	1	2	3	4	5	6
M × RF	0	N/A	N/A	N/A	N/A	N/A	N/A	N/A
	1	N/A	N/A	N/A	N/A	N/A	N/A	N/A
	2	N/A	N/A	24.8	N/A	N/A	N/A	N/A
	3	N/A	N/A	N/A	32	N/A	N/A	N/A
	4	N/A	N/A	N/A	N/A	44.2	N/A	N/A
	5	N/A	N/A	N/A	N/A	N/A	48.6	N/A

RF = 76 GHz at  $\text{RFIN} = -10\text{ dBm}$ , LO frequency = 12.33 GHz at  $\text{LOIN} = 2\text{ dBm}$ .

		N × LO						
		0	1	2	3	4	5	6
M × RF	0	N/A	N/A	N/A	N/A	N/A	N/A	N/A
	1	N/A	N/A	N/A	N/A	N/A	N/A	N/A
	2	N/A	N/A	24.4	N/A	N/A	N/A	N/A
	3	N/A	N/A	N/A	36.8	N/A	N/A	N/A
	4	N/A	N/A	N/A	N/A	47.2	N/A	N/A
	5	N/A	N/A	N/A	N/A	N/A	54.6	N/A

**$M \times N$  Spurious Outputs,  $V_{\text{DLNA}} = 3\text{ V}$**

RF = 71 GHz at  $\text{RFIN} = -10\text{ dBm}$ , LO frequency = 11.5 GHz at  $\text{LOIN} = 2\text{ dBm}$ .

		N × LO						
		0	1	2	3	4	5	6
M × RF	0	N/A	N/A	N/A	N/A	N/A	N/A	N/A
	1	N/A	N/A	N/A	N/A	N/A	N/A	N/A
	2	N/A	N/A	25.3	N/A	N/A	N/A	N/A
	3	N/A	N/A	N/A	40.1	N/A	N/A	N/A
	4	N/A	N/A	N/A	N/A	46.3	N/A	N/A
	5	N/A	N/A	N/A	N/A	N/A	66.4	N/A

RF = 73 GHz at  $\text{RFIN} = -10\text{ dBm}$ , LO frequency = 11.83 GHz at  $\text{LOIN} = 2\text{ dBm}$ .

		N × LO						
		0	1	2	3	4	5	6
M × RF	0	N/A	N/A	N/A	N/A	N/A	N/A	N/A
	1	N/A	N/A	N/A	N/A	N/A	N/A	N/A
	2	N/A	N/A	24.5	N/A	N/A	N/A	N/A
	3	N/A	N/A	N/A	36.1	N/A	N/A	N/A
	4	N/A	N/A	N/A	N/A	42.6	N/A	N/A
	5	N/A	N/A	N/A	N/A	N/A	48.1	N/A

RF = 76 GHz at  $\text{RFIN} = -10\text{ dBm}$ , LO frequency = 12.33 GHz at  $\text{LOIN} = 2\text{ dBm}$ .

		N × LO						
		0	1	2	3	4	5	6
M × RF	0	N/A	N/A	N/A	N/A	N/A	N/A	N/A
	1	N/A	N/A	N/A	N/A	N/A	N/A	N/A
	2	N/A	N/A	23.9	N/A	N/A	N/A	N/A
	3	N/A	N/A	N/A	35.5	N/A	N/A	N/A
	4	N/A	N/A	N/A	N/A	45	N/A	N/A
	5	N/A	N/A	N/A	N/A	N/A	52.2	N/A

### THEORY OF OPERATION

The HMC7586 is a GaAs low noise I/Q downconverter with an integrated LO buffer and a 6× multiplier. See Figure 210 for a functional block diagram of the downconverter circuit architecture.

The RF input is internally ac-coupled and matched to 50 Ω. The input passes through four stages of low noise amplification. The preamplified RF input signal then splits and drives two singly

balanced passive mixers. Quadrature LO signals drive the two I and Q mixer cores. The LO path provides a 6× multiplier that allows the use of a lower frequency range LO input signal, typically between 11.83 GHz and 14.33 GHz. The 6× multiplier is implemented using a cascade of 3× and 2× multipliers. The LO buffer amplifiers are included on chip to allow a typical LO drive level of only 2 dBm for full performance.

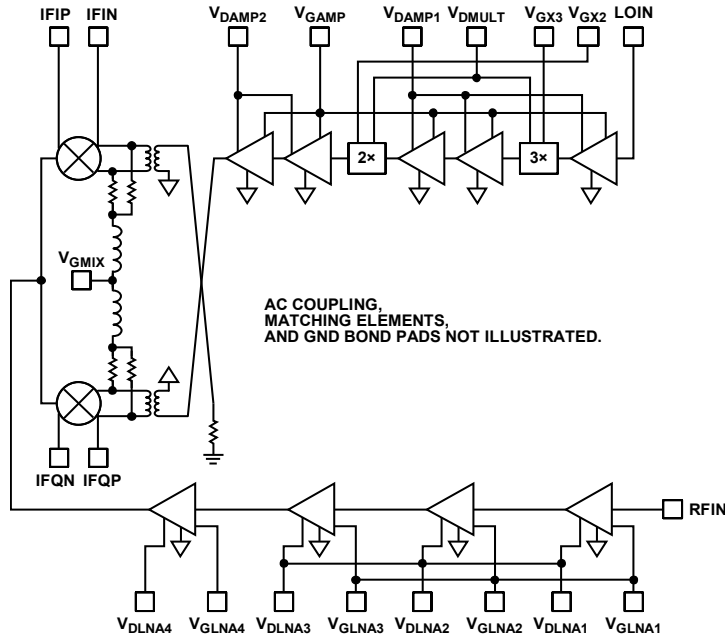

Figure 210. Downconverter Circuit Architecture

13 128-230

# APPLICATIONS INFORMATION

## BIASING SEQUENCE

The HMC7586 uses several amplifier and multiplier stages. The active stages all utilize depletion mode pHEMT transistors. It is important to follow the following power-up bias sequence to ensure transistor damage does not occur.

1. Apply a  $-2\text{ V}$  bias to  $V_{GAMP}$ ,  $V_{GLNA1}$ ,  $V_{GLNA2}$ ,  $V_{GLNA3}$ ,  $V_{GLNA4}$ ,  $V_{GX2}$ , and  $V_{GX3}$ .
2. Apply a  $-1\text{ V}$  bias to  $V_{GMIX}$ .
3. Apply  $4\text{ V}$  to  $V_{DAMP1}$ ,  $V_{DAMP2}$ ,  $V_{DLNA1}$ ,  $V_{DLNA2}$ ,  $V_{DLNA3}$ , and  $V_{DLNA4}$ , and apply  $1.5\text{ V}$  to  $V_{DMULT}$ .
4. Adjust  $V_{GAMP}$  between  $-2\text{ V}$  and  $0\text{ V}$  to achieve a total amplifier drain current ( $I_{DAMP1} + I_{DAMP2}$ ) of  $175\text{ mA}$ .
5. Adjust  $V_{GLNA1}$ ,  $V_{GLNA2}$ ,  $V_{GLNA3}$ , and  $V_{GLNA4}$  to achieve a total LNA drain current ( $I_{DLNA1} + I_{DLNA2} + I_{DLNA3} + I_{DLNA4}$ ) of  $50\text{ mA}$ .
6. Apply an LO input signal with a power level of  $\sim 2\text{ dBm}$  and adjust  $V_{GX2}$  and  $V_{GX3}$  between  $2\text{ V}$  and  $0\text{ V}$  to achieve  $80\text{ mA}$  of drain current on  $V_{DMULT}$ .

To power down the HMC7586, follow the reverse procedure.

For additional guidance on general bias sequencing, see the [MMIC Amplifier Biasing Procedure](#) application note.

## IMAGE REJECTION DOWNCONVERSION

A typical image rejection downconversion application circuit is shown in Figure 211. For image rejection downconversion, external  $180^\circ$  and  $90^\circ$  hybrid couplers are typically used. The  $180^\circ$  hybrids or baluns convert the differential I and Q output signals to unbalanced waveforms. The  $90^\circ$  hybrid then combines the outputs in quadrature to form a classic Hartley image rejection receiver with a typical image rejection of  $28\text{ dBc}$ .

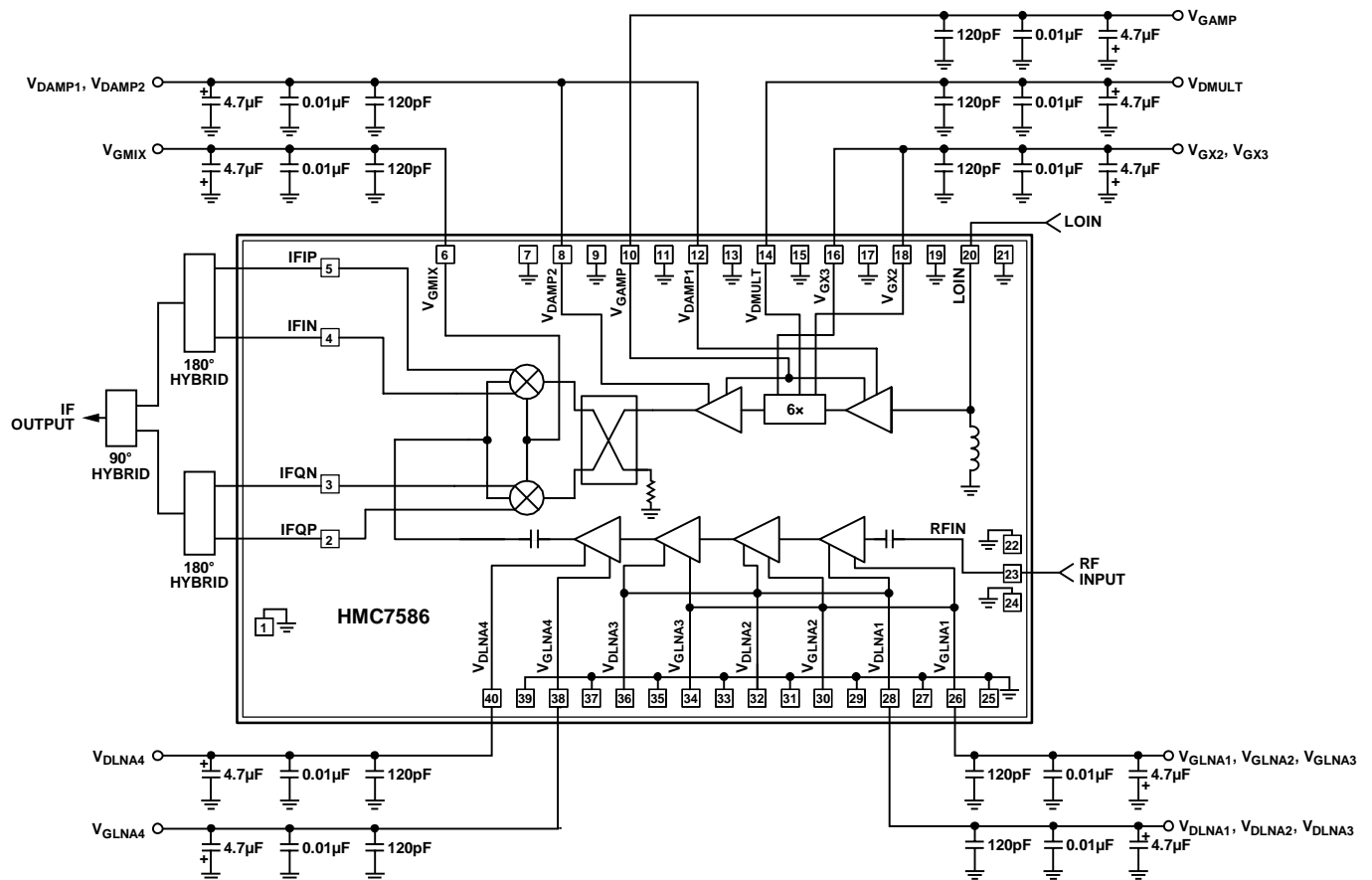

Figure 211. Typical Image Rejection Downconversion Application Circuit

13158-231

ZERO IF DIRECT CONVERSION

A typical zero IF direct conversion application circuit is shown in Figure 212. It is important to ac couple the IFIP, IFIN, IFQP, and IFQN pads to the ADC inputs. Most ADCs are designed to operate with a common-mode voltage that is above ground.

The HMC7586 I/Q outputs are ground referenced, and dc coupling to a differential signal source with a common-mode output voltage other than 0 V may cause degraded RF performance and possible device damage due to electrical overstress.

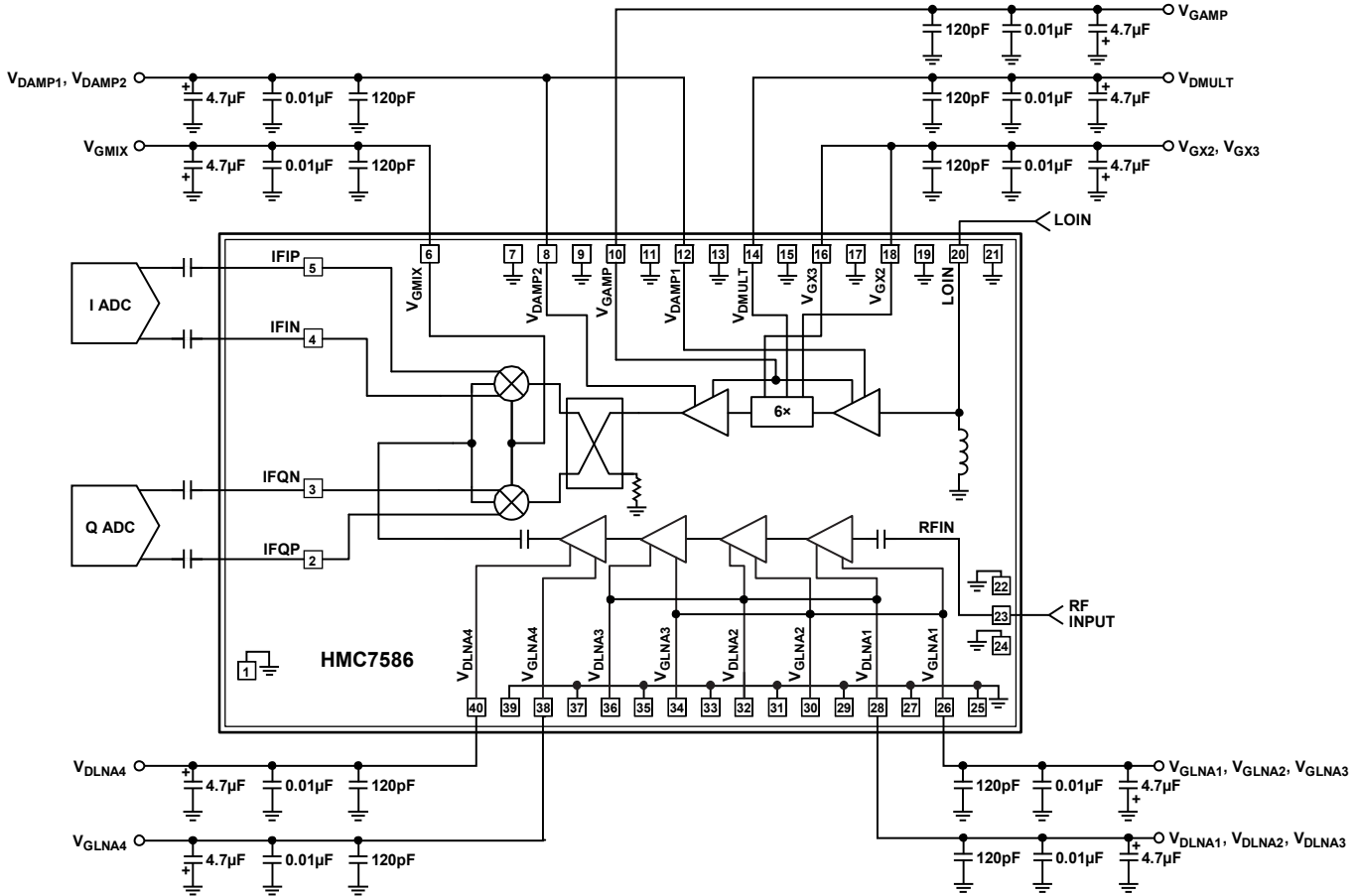

Figure 212. Typical Zero IF Direct Conversion Application Circuit

1312E-232

ASSEMBLY DIAGRAM

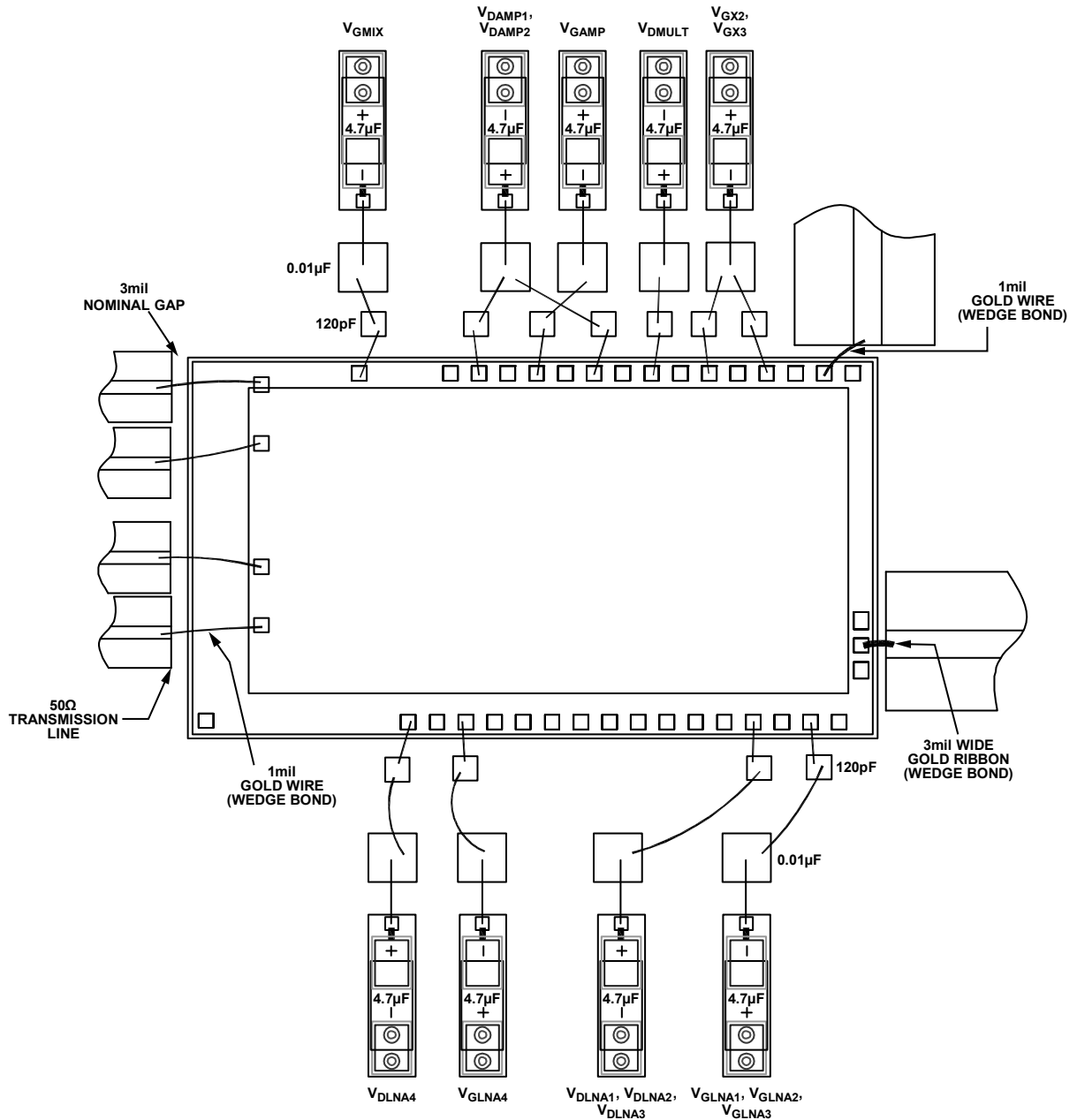

Figure 213. Assembly Diagram

13126-234

## MOUNTING AND BONDING TECHNIQUES FOR MILLIMETERWAVE GaAs MMICS

Attach the die directly to the ground plane eutectically or with conductive epoxy.

To bring RF to and from the chip, use 50  $\Omega$  microstrip transmission lines on 0.127 mm (5 mil) thick alumina thin film substrates (see Figure 214).

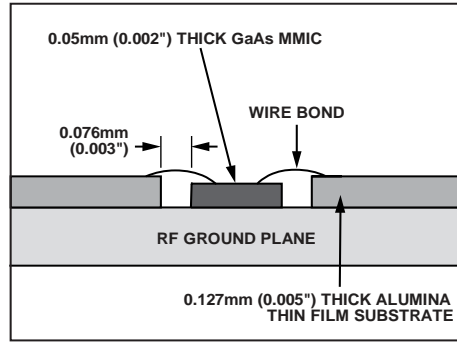

Figure 214. Routing RF Signals

To minimize bond wire length, place microstrip substrates as close to the die as possible. Typical die to substrate spacing is 0.076 mm to 0.152 mm (3 mil to 6 mil).

### HANDLING PRECAUTIONS

To avoid permanent damage, adhere to the following precautions.

#### Storage

All bare die ship in either waffle or gel-based ESD protective containers, sealed in an ESD protective bag. After opening the sealed ESD protective bag, store all die a dry nitrogen environment.

#### Cleanliness

Handle the chips in a clean environment. Never use liquid cleaning systems to clean the chip.

#### Static Sensitivity

Follow ESD precautions to protect against ESD strikes that are greater than 100 V.

#### Transients

Suppress instrument and bias supply transients while bias is applied. To minimize inductive pickup, use shielded signal and bias cables.

### General Handling

Handle the chip on the edges only using a vacuum collet or with a sharp pair of bent tweezers. Because the surface of the chip has fragile air bridges, never touch the surface of the chip with a vacuum collet, tweezers, or fingers.

### MOUNTING

The chip is back metallized and can be die mounted with gold/tin (AuSn) eutectic preforms or with electrically conductive epoxy. The mounting surface must be clean and flat.

#### Eutectic Die Attach

It is best to use an 80%/20% gold tin preform with a work surface temperature of 255°C and a tool temperature of 265°C. When hot 90%/10% nitrogen/hydrogen gas is applied, maintain tool tip temperature at 290°C. Do not expose the chip to a temperature greater than 320°C for more than 20 sec. No more than 3 sec of scrubbing is required for attachment.

#### Epoxy Die Attach

ABLEBOND 84-1LMIT is recommended for die attachment. Apply a minimum amount of epoxy to the mounting surface so that upon placing it into position, a thin epoxy fillet is observed around the perimeter of the chip. Cure epoxy per the schedule provided by the manufacturer.

### WIRE BONDING

RF bonds made with 3 mil (0.0762 mm)  $\times$  0.5 mil (0.0127 mm) gold ribbon are recommended for RF port and wedge bonds with 1 mil (0.0254 mm) diameter gold wire are recommended for IF and LO ports. Thermosonically bond these bonds with a force of 40 g to 60 g. DC bonds of 1 mil (0.0254 mm) diameter, thermosonically bonded, are recommended. Create ball bonds with a force of 40 g to 50 g and wedge bonds with a force of 18 g to 22 g. Create all bonds with a nominal stage temperature of 150°C. Apply a minimum amount of ultrasonic energy to achieve reliable bonds. Keep all bonds as short as possible, less than 12 mil (0.31 mm).

# OUTLINE DIMENSIONS

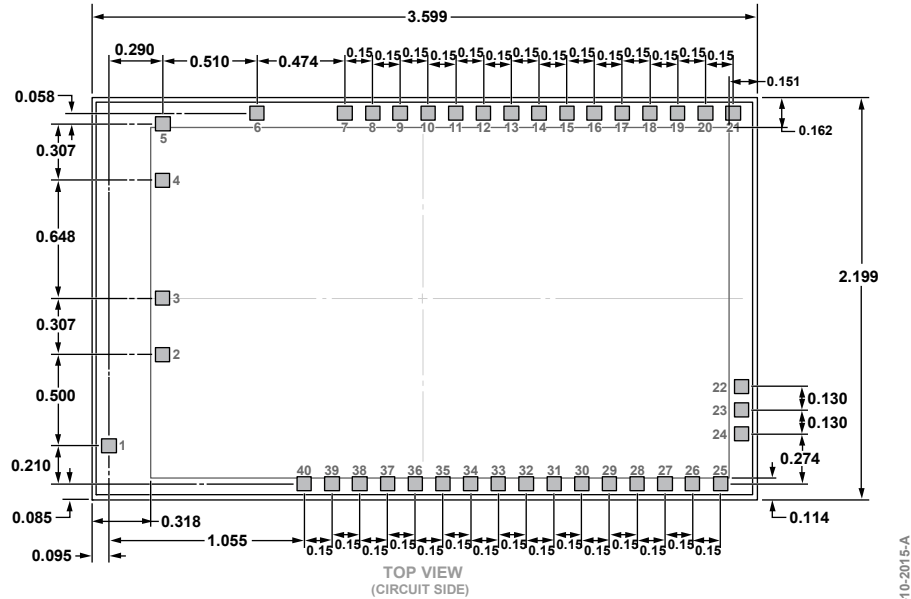

Figure 215. 40-Pad Bare Die [CHIP]  
(C-40-1)  
Dimensions shown in millimeters

04-10-2015-A

## ORDERING GUIDE

Model <sup>1</sup>	Temperature Range	Package Description	Package Option <sup>2</sup>
HMC7586	-55°C to +85°C	40-Pad Bare Die [CHIP]	C-40-1
HMC7586-SX	-55°C to +85°C	40-Pad Bare Die [CHIP]	C-40-1

<sup>1</sup> The HMC7586-SX consists of two pairs of the die in a gel pack for sample orders.

<sup>2</sup> This is a waffle pack option; contact Analog Devices, Inc. for additional packaging options.

Компания «Океан Электроники» предлагает заключение долгосрочных отношений при поставках импортных электронных компонентов на взаимовыгодных условиях!

Наши преимущества:

- Поставка оригинальных импортных электронных компонентов напрямую с производств Америки, Европы и Азии, а так же с крупнейших складов мира;
- Широкая линейка поставок активных и пассивных импортных электронных компонентов (более 30 млн. наименований);
- Поставка сложных, дефицитных, либо снятых с производства позиций;
- Оперативные сроки поставки под заказ (от 5 рабочих дней);
- Экспресс доставка в любую точку России;
- Помощь Конструкторского Отдела и консультации квалифицированных инженеров;
- Техническая поддержка проекта, помощь в подборе аналогов, поставка прототипов;
- Поставка электронных компонентов под контролем ВП;
- Система менеджмента качества сертифицирована по Международному стандарту ISO 9001;
- При необходимости вся продукция военного и аэрокосмического назначения проходит испытания и сертификацию в лаборатории (по согласованию с заказчиком);
- Поставка специализированных компонентов военного и аэрокосмического уровня качества (Xilinx, Altera, Analog Devices, Intersil, Interpoint, Microsemi, Actel, Aeroflex, Peregrine, VPT, Syfer, Eurofarad, Texas Instruments, MS Kennedy, Miteq, Cobham, E2V, MA-COM, Hittite, Mini-Circuits, General Dynamics и др.);

Компания «Океан Электроники» является официальным дистрибьютором и эксклюзивным представителем в России одного из крупнейших производителей разъемов военного и аэрокосмического назначения «JONHON», а так же официальным дистрибьютором и эксклюзивным представителем в России производителя высокотехнологичных и надежных решений для передачи СВЧ сигналов «FORSTAR».



## JONHON

«JONHON» (основан в 1970 г.)

Разъемы специального, военного и аэрокосмического назначения:

(Применяются в военной, авиационной, аэрокосмической, морской, железнодорожной, горно- и нефтедобывающей отраслях промышленности)

«FORSTAR» (основан в 1998 г.)

ВЧ соединители, коаксиальные кабели, кабельные сборки и микроволновые компоненты:

(Применяются в телекоммуникациях гражданского и специального назначения, в средствах связи, РЛС, а так же военной, авиационной и аэрокосмической отраслях промышленности).



Телефон: 8 (812) 309-75-97 (многоканальный)

Факс: 8 (812) 320-03-32

Электронная почта: [ocean@oceanchips.ru](mailto:ocean@oceanchips.ru)

Web: <http://oceanchips.ru/>

Адрес: 198099, г. Санкт-Петербург, ул. Калинина, д. 2, корп. 4, лит. А