

# APPLICATION TOOLING

## Crimping tools and machines

## Crimping tools and machines

The arrow mark indicates the press that is applicable to the applicator.

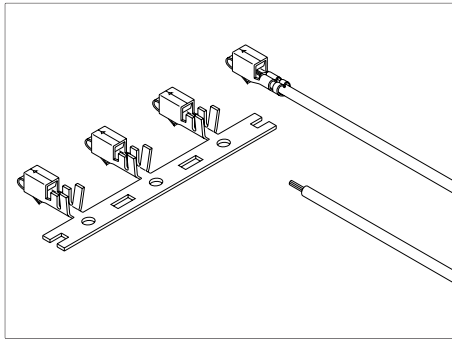

**Strip-crimp applicator for side feeding terminals**

MKS-SC

**Crimping applicator for end-feeding terminals**

MK-L

**Semi-automatic press**

Semi-automatic crimping machines (presses) contact a wire to a chain terminal each time a footswitch is pressed.

AP-K2N

- Dimensions: (W×L×H)280×480×505mm
- Weight: Approx. 90kg(198lb)
- Power source: 100V AC, Single-phase 50/60Hz
- Pressure output: 14.7kN[1,500kg(3307lb)]
- Dies: Applicator replacement

**Crimping applicator for side-feeding terminals**

MKS-L

**Crimping applicator for end-feeding flag terminals**

MKF-L









**Compact crimping applicator for side-feeding terminals**

MKS-LS

# Hand tools

## Crimping tools

## Crimping tools

Terminals and parts model number in alphabetical order	Hand tools						Hand tools		Extraction and Insertion tools	
	for chain terminals	for loose piece terminals					for loose piece terminals		Extraction tool	Insertion tool
	YRS series	YC series	YRM series	YRF series	YRK series	YRK-EX series				
										
	Dimensions: (WxL) 59x224mm	Dimensions: (WxL) 70x296mm	Dimensions: (WxL) 59x224mm	Dimensions: (WxL) 70x295mm 80x305mm	Dimensions: (WxLxD) 75x314x25mm	Dimensions: (WxLxD) 75x314x25mm				
	<b>Crimping tools</b> It is the manual tool that is convenient to terminate very small quantity of contacts for prototype or maintenance. It is composed of two crimping dies for the conductor and insulation, and can be crimp easily. YRK and YRK-EX can be used for mass-production.  Note: (1) These tools are for prototype tooling or repair. (2) YC tool has two crimping sections (A and B). YRS tool has also two crimping sections by inverting upper dies. Be sure to check applicable wires before use. Since the dies are fixed, the crimping height cannot be adjusted. Therefore, some of the applicable wires described in this catalog may not be crimped properly. Before use, check for proper crimping (such as tensile strength, terminal/contact deformation). (3) These tools are not applicable to 2-wire crimping. (4) When hand crimping board-in terminals (SAN, SCN, SDN, SGN, SIN, SJN, SZN), care should be taken not to contaminate the solder tails of the terminals, as with greasy or oily fingers. If a solder problem arises, some cleaning of the tips of the terminal is advisable. (5) WC and JUC hand tools are provided by J.S.T.(U.K.) LTD. and contact them about the details of these hand tools.									
	YRS series	YC series	YRM series	YRF series	YRK · YRK-EX series		WC & JUC series JUK's Hand Tools	Terminal in loose form model No.		
JK-SP/SS2**	YRS-370	-	-	-	-	-	-	-	KEJ-0.7 for plug, KEJ-0.4 for socket	-
J-SP/SS1**	YRS-440	YC-440	-	-	-	-	-	J-BP/BS1**	DEJ-0.3	-
J-SP/SS2**	YRS-330	-	-	-	-	-	-	-	DEJ-0.3	-
LFO-1.0-250N	-	-	-	-	-	-	JUCS-FO	-	-	-
LFO-2.5-250N	-	-	-	-	-	-	JUCS-FO	-	-	-
MD-SP12**	YRS-470	-	-	-	-	-	-	-	MEJ-06	-
MD-SP22**	YRS-460	-	-	-	-	-	-	-	MEJ-06	-
RA-SC1290	YRS-231	-	YRM-232 YRM-233	-	-	-	-	RA-BC12**	EJ-RA	-
RF-SC22**	-	-	YRM-230	-	-	-	-	RF-BC22**	-	-
RPJ-SP/SS2331	YRS-331	-	-	-	-	-	-	-	EJ-RPJ	-
SAA-21(T)-**	-	YC-141	-	-	-	-	-	LAA-21(T)-**	-	-
SAA-50(T)-**	-	YC-182	-	-	-	-	-	LAA-50(T)-**	-	-
SAA-51(T)-**	-	YC-142	-	-	-	-	-	LAA-51(T)-**	-	-
SAB-51(T)-**	-	YC-142	-	-	-	-	-	LAB-51(T)-**	-	-
SACH-003G-P0.2	YRS-1190	-	-	-	-	-	-	-	-	-
SACH-002GU-P0.3	YRS-858	-	-	-	-	-	-	-	-	-
SAN-002T-0.8A SAN-002T-0.8K	YRS-220	-	-	-	-	-	-	-	EJ-PH	-
SBH-001T-P0.5	-	YC-670R	-	-	-	-	WC-670	BBH-001T-P0.5	-	-
SBHL-002T-P0.5	YRS-857	-	-	-	-	-	-	-	-	-
SBHM-001T-P0.5	-	YC-670R	-	-	-	-	-	BBHM-001T-P0.5	EJ-BHMR	-
SBHS-002T-P0.5A	YRS-852	-	-	-	-	-	-	-	EJ-BHS2	-
SBHS-002T-P0.5A	-	-	-	-	-	-	-	-	EJ-BHS2	-
SBHSM-002T-P0.5	YRS-854	-	-	-	-	-	-	-	EJ-BHSW	-
SBHT-002T-P0.5	YRS-856 YRS-857	-	-	-	-	-	-	-	EJ-BHT	-
SBN-001T-1.0	YRS-170	YC-170R	-	-	-	-	-	BBN-001T-1.0	-	-
SCN-001T-1.0K SCN-001T-P1.0	YRS-191	YC-191R	-	-	-	-	WC-191	BCN-001T-1.0K BCN-001T-P1.0	-	-
SCS-41T-2.3	-	-	-	-	-	-	-	-	CSJ-23	-
SCSN-41T-P2.3	-	-	-	-	-	-	-	-	EJ-CSN	-
SCZH-002T-P0.5	YRS-492	-	-	-	-	-	-	-	-	-

Note: Contact JST for wire range.

## Crimping tools

Terminals and parts model number in alphabetical order	Hand tools						Hand tools		Extraction and Insertion tools	
	for chain terminals	for loose piece terminals				for loose piece terminals		Extraction tool	Insertion tool	
	YRS series	YC series	YRM series	YRF series	YRK · YRK-EX series	WC & JUC series JUK's Hand Tools	Terminal in loose form model No.			
SDF-01T-1.0A	-	YC-045	-	-	-	-	-	LDF-01T-1.0A	-	-
SDF-01T-1.3AS	-	YC-045	-	-	-	-	-	LDF-01T-1.3AS	-	-
SDN-21T-P1.5	-	YC-600R	-	-	-	-	-	BDN-21T-P1.5	-	-
SDY-01T-P1.6ASV	-	YC-525R	-	-	-	-	-	BDY-01T-P1.6ASV	SLJ-1.4	-
SEH-001T-P0.6	YRS-260	YC-260R	-	-	-	-	WC-260	BEH-001T-P0.6	EJ-PH	-
SEH-001T-P0.6L	-	-	-	-	-	-	-	-	EJ-PH	-
SEH-002T-P0.6L	-	-	-	-	-	-	-	-	EJ-PH	-
SEH-003T-P0.6L	-	-	-	-	-	-	-	-	EJ-PH	-
SF1F-002(*)-P0.6	-	-	-	-	YRK-1220	-	-	-	EJ-JFAJ1100	-
SF1M-002(*)-M0.6A	-	-	-	-	YRK-1220	-	-	-	EJ-JFAJ1100	-
SF1F-21(*)-P0.6	-	-	-	-	YRK-1210	-	-	-	EJ-JFAJ1100	-
SF1M-21(*)-M0.6A	-	-	-	-	YRK-1210	-	-	-	EJ-JFAJ1100	-
SF3F-002(*)-P2.0	-	-	-	YRF-882	YRK-8821	-	-	BF3F-002(*)-P2.0	EJ-JFAJ3	-
SF3F-01(*)-P2.0	-	-	-	YRF-881	YRK-8811	-	-	BF3F-01(*)-P2.0	EJ-JFAJ3	-
SF3M-01(*)-M2.0N	-	-	-	YRF-881	YRK-8811	-	-	BF3M-01(*)-M2.0N	EJ-JFAJ3	-
SF3F-41(*)-P2.0	-	-	-	YRF-880	YRK-8801	-	-	LF3F-41(*)-P2.0	EJ-JFAJ3	-
SF3M-41(*)-M2.0N	-	-	-	YRF-880	YRK-8801	-	-	LF3M-41(*)-M2.0N	EJ-JFAJ3	-
SF3F-71(*)-P2.0	-	-	-	YRF-1070	YRK-1071	-	-	BF3F-71(*)-P2.0	EJ-JFAJ3	-
SF3M-71(*)-M2.0N	-	-	-	YRF-1071	YRK-1071	-	-	BF3M-71(*)-M2.0N	EJ-JFAJ3	-
SFO-41(T)-187N(-8)	-	YC-271	-	-	-	-	-	LFO-41(T)-187N	-	-
SFO-61(T)-250A	-	YC-270	-	-	-	-	-	LFO-61(T)-250A	-	-
SFPS-61T-250	-	YC-272	-	-	-	-	-	LFPS-61(T)-250	-	-
SFT-61T-250N	-	YC-510	-	-	-	-	-	LFT-61T-250N	-	-
SGF-41(T)-4	-	YC-055	-	-	-	-	-	LGF-41(T)-4	-	-
SGF-51(T)-5	-	YC-065	-	-	-	-	-	LGF-51(T)-5	-	-
SGM-51T-5	-	YC-056	-	-	-	-	-	LGM-51T-5	-	-
SHCM-A03T-P025	YRS-960	-	-	-	-	-	WC-SHCM-A03	-	-	-
SHF-001T-0.8BS	YRS-122	YC-122R	-	-	-	-	WC-122	BHF-001T-0.8BS	EJ-SMP	-
SHF-002T-0.8BS	YRS-300	-	-	-	-	-	-	-	EJ-SMP	-
SHIF-01T-P0.5	-	YC-986R	-	-	-	-	-	-	EJ-HILP	-
SHIF-21T-P0.5	-	YC-995R	-	-	-	-	-	-	EJ-HILP	-
SHIM-01T-P0.5	-	YC-986R	-	-	-	-	-	-	EJ-HILR	-
SHIM-21T-P0.5	-	YC-995R	-	-	-	-	-	-	EJ-HILR	-
SHR-001T-P0.6	YRS-580	YC-580R	-	-	-	-	-	BHR-001T-P0.6	-	-
SIM-01(T)-110A	-	YC-054	-	-	-	-	-	LIM-01(T)-110A	-	-
SIM-1.0-250D/N	-	-	-	-	-	-	JUCS-IM	-	-	-
SIM-2.5-250D/N	-	-	-	-	-	-	JUCS-IM	-	-	-
SIM-41(T)-110B	-	YC-067	-	-	-	-	-	LIM-41(T)-110B	-	-
SIM-51(T)-250N	-	YC-321	-	-	-	-	-	LIM-51(T)-250N	-	-
SIN-001T-1.2	YRS-034	-	-	-	-	-	-	-	-	-
SIN-002T-1.0S	YRS-035	-	-	-	-	-	-	-	-	-
SIN-01T-1.2	-	YC-340R	-	-	-	-	-	LIN-01T-1.2	-	-
SIN-01T-1.8	-	YC-032	-	-	-	-	-	LIN-01T-1.8	-	-
SIN-01T-1.8N	-	YC-032	-	-	-	-	-	LIN-01T-1.8N	-	-
SIN-21T-1.8	-	YC-350	-	-	-	-	-	LIN-21T-1.8	-	-
SIN-21T-1.8S	-	YC-570 YC-571	-	-	-	-	-	LIN-21T-1.8S	-	-
SIN-61T-2.6S	-	YC-560	-	-	-	-	-	LIN-61T-2.6S	-	-
SIN-81T-3.6S	-	YC-940	-	-	-	-	-	LIN-81T-3.6S	-	-

Note: Contact JST for wire range.

## Crimping tools

Terminals and parts model number in alphabetical order	Hand tools					Hand tools			Extraction and Insertion tools	
	for chain terminals	for loose piece terminals				for loose piece terminals			Extraction tool	Insertion tool
	YRS series	YC series	YRM series	YRF series	YRK · YRK-EX series	WC & JUC series JUK's Hand Tools	Terminal in loose form model No.			
SJ2F-002GF-P1.0	YRS-8851	--	--	--	YRK-8851	--	--	EJ-JFAJ2N	--	
SJ2M-002GF-M1.0N	YRS-8851	--	--	--	YRK-8851	--	--	EJ-JFAJ2N	--	
SJ2F-01GF-P1.0	YRS-8861	--	--	--	YRK-8861	--	--	EJ-JFAJ2N	--	
SJ2M-01GF-M1.0N	YRS-8861	--	--	--	YRK-8861	--	--	EJ-JFAJ2N	--	
SJ2M-01GF-M1.0S	YRS-8861	--	--	--	YRK-8861	--	--	EJ-JFAJ2N	--	
SJ2F-21GF-P1.0	--	--	--	YRF-1120	YRK-1120	--	LJ2F-21GF-P1.0	EJ-JFAJ2N	--	
SJ2M-21GF-M1.0N	--	--	--	YRF-1120	YRK-1120	--	LJ2M-21GF-M1.0N	EJ-JFAJ2N	--	
SJ4F-71GF-M3.0	--	--	--	YRF-1130	--	--	BJ4F-71GF-M3.0	EJ-JFAJ4	--	
SJ4F-81GF-M3.0	--	--	--	YRF-1370	--	--	BJ4F-81GF-M3.0	EJ-JFAJ4	--	
SJ5F-71GF-M6.5	--	--	--	YRF-888	--	--	LJ5F-71GF-M6.5	EJ-JFAJ5	--	
SJ5M-71GF-M6.5	--	--	--	YRF-888	--	--	LJ5M-71GF-M6.5	EJ-JFAJ5	--	
SJ5F-81GF-M6.5	--	--	--	YRF-889	--	--	LJ5F-81GF-M6.5	EJ-JFAJ5	--	
SJ5M-81GF-M6.5	--	--	--	YRF-889	--	--	LJ5M-81GF-M6.5	EJ-JFAJ5	--	
SJ5F-91GF-M6.5	--	--	--	--	--	--	LJ5F-91GF-M6.5	EJ-JFAJ5	--	
SJ5M-91GF-M6.5	--	--	--	--	--	--	LJ5M-91GF-M6.5	EJ-JFAJ5	--	
SJN-001PT-0.9	YRS-1181	--	--	--	--	--	--	--	--	
SJN-002PT-0.9	YRS-036	--	--	--	--	--	--	--	--	
SLC-21T-2.0	--	YC-310	--	--	--	WC-310	LLC-21T-2.0	EJ-LC	--	
SLC-22T-2.0	--	--	--	--	--	--	--	EJ-LC	--	
SLC-001T-P2.0	--	--	--	--	--	--	--	EJ-LCL	--	
SLC-02T-P2.0	--	--	--	--	--	--	--	EJ-LCL	--	
SLF/M-01T-P1.3E	--	YC-202	YRM-201	--	--	WC-202	LLF/M-01T-P1.3E	LEJ-13	LIT-2013	
SLF/M-41T-P1.3E	--	YC-203	--	--	--	WC-203	LLF/M-41T-P1.3E	LEJ-13	--	
SMF-01T-1.0	--	YC-081	--	--	--	--	LMF-01T-1.0	--	--	
SMF-01T-1.3	--	YC-082	--	--	--	--	LMF-01T-1.3	--	--	
SMM-003T-P0.5	YRS-800	--	--	--	--	WC-800	--	--	--	
SMR-001T-0.6	YRS-580	YC-580R	--	--	--	--	BMR-001T-0.6	--	--	
SOM-21(T)-187	--	YC-680	--	--	--	--	LOM-21(T)-187	--	--	
SOM-51(T)-250	--	YC-066	--	--	--	WC-066	LOM-51(T)-250	--	--	
SOTZP-002GD-P0.18	--	--	--	--	--	--	--	EJ-OTZS	--	
SPA-001T-P0.5	--	YC-610R YC-611R	--	--	--	--	BPA-001T-P0.5	EJ-PH	--	
SPAL-001T-P0.5	--	YC-610R YC-611R	--	--	--	--	BPAL-001T-P0.5	EJ-PAL	--	
SPAL-002T-P0.5	YRS-1340	--	--	--	--	--	--	EJ-PAL	--	
SPB-1.0-250N-S	--	--	--	--	--	JUCS-PB	--	--	--	
SPB-2.5-250N-S	--	--	--	--	--	JUCS-PB	--	--	--	
SPF-01T-2.5C	--	YC-043R	--	--	--	--	LPF-01T-2.5C	--	--	
SPH-001T-P0.5L	YRS-245	--	--	--	--	--	--	--	--	
SPH-002T-P0.5L	YRS-241	--	--	--	--	--	--	EJ-PH	--	
SPH-002T-P0.5S	YRS-240	--	YRM-240	--	--	WC-240	BPH-002T-P0.5S	EJ-PH	--	
SPH-004T-P0.5S	YRS-243	--	--	YRS-243	--	--	--	EJ-PH	--	
SPHD-001T-P0.5	--	YC-610R YC-611R	--	--	--	WC-610	BPHD-001T-P0.5	EJ-PHD-RB	--	
SPHD-002T-P0.5	YRS-620	--	YRM-620	--	--	WC-620	BPHD-002T-P0.5	EJ-PHD-RB	--	
SPLI-002T-P0.5	YRS-1410	--	--	--	--	--	--	--	--	
SPND-001T-C0.5	YRS-1091	--	--	--	--	--	--	EJ-PND	--	
SPND-002T-C0.5	YRS-1090	--	--	--	--	--	--	EJ-PND	--	

Note: Contact JST for wire range.

Crimping tools

Terminals and parts model number in alphabetical order	Hand tools					Hand tools			Extraction and Insertion tools	
	for chain terminals	for loose piece terminals				for loose piece terminals			Extraction tool	Insertion tool
	YRS series	YC series	YRM series	YRF series	YRK · YRK-EX series	WC & JUC series JUK's Hand Tools	Terminal in loose form model No.			
SPS-01T-110	-	YC-740	-	-	-		WC-740	LPS-01T-110	-	-
SPS-01T-187(-8)	-	YC-730 YC-731	-	-	-		WC-730	LPS-01T-187(-8)	EJ-PS187	-
SPS-21T-205(-5)	-	YC-760	-	-	-		-	LPS-21T-205(-5)	-	-
SPS-21T-250	-	YC-780	-	-	-		WC-780	LPS-21T-250	EJ-PS250	-
SPS-21T-250S	-	YC-780	-	-	-		WC-780	LPS-21T-250S	EJ-PS250	-
SPS-41T-110	-	YC-750 YC-751	-	-	-		WC-750	LPS-41T-110	-	-
SPS-51T-187(-8)	-	YC-710 YC-711	-	-	-		WC-710	LPS-51T-187(-8)	EJ-PS187	-
SPS-51T-205	-	YC-770 YC-771	-	-	-		-	LPS-51T-205	-	-
SPS-61T-250	-	YC-720	-	-	-		WC-720	LPS-61T-250	EJ-PS250	-
SPS-61T-250S	-	YC-721	-	-	-		-	LPS-61T-250S	EJ-PS250	-
SPS-91T-250	-	-	-	YRF-790	-		-	BPS-91T-250	EJ-PS250	-
SPS-91T-250S	-	-	-	YRF-791	-		-	BPS-91T-250S	EJ-PS250	-
SPUD-001T-P0.5	YRS-1320	-	-	-	-		-	-	EJ-PUD	-
SPUD-002T-P0.5	-	-	-	-	-		-	-	EJ-PUD	-
SPXA-001T-P0.6	-	-	-	-	-		-	-	EJ-PXA	-
SRA-20(T)-**	-	YC-181	-	-	-		-	LRA-20(T)-**	-	-
SRA-21(T)-**	-	YC-141	-	-	-		-	LRA-21(T)-**	-	-
SRA-50(T)-**	-	YC-182	-	-	-		-	LRA-50(T)-**	-	-
SRA-51(T)-**	-	YC-142	-	-	-		-	LRA-51(T)-**	-	-
SRB-1.0(-)	-	-	-	-	-		JUCS-RB/RT	-	-	-
SRB-2.5(-)	-	-	-	-	-		JUCS-RB/RT	-	-	-
SRB-51(T)-**	-	YC-142	-	-	-		-	LRB-51(T)-**	-	-
SRC-01(T)-**	-	YC-033	-	-	-		-	LRC-01(T)-**	-	-
SRC-50(T)-**	-	YC-183	-	-	-		-	LRC-50(T)-**	-	-
SRC-51(T)-**	-	YC-142	-	-	-		-	LRC-51(T)-**	-	-
SRF-51(T)-**	-	YC-142	-	-	-		-	LRF-51(T)-**	-	-
SRT-1.0(-)	-	-	-	-	-		JUCS-RB/RT	-	-	-
SRT-2.5(-)	-	-	-	-	-		JUCS-RB/RT	-	-	-
SRT-51T-**	-	YC-143R	-	-	-		-	LRT-51T-**	-	-
SRWF-01GG-M0.6	-	-	-	-	-		-	-	EJ-RPZ	-
SRWM-01GG-S0.6	-	-	-	-	-		-	-	EJ-RPZ	-
SRWF-21GG-M0.6	-	-	-	-	-		-	-	EJ-RPZ	-
SRWM-21GG-S0.6	-	-	-	-	-		-	-	EJ-RPZ	-
SRWF-61GG-M0.6	-	YC-840R	-	-	-		-	BRWF-61GG-M0.6	EJ-RPZ	-
SRWM-61GG-S0.6	-	YC-840R	-	-	-		-	BRWM-61GG-S0.6	EJ-RPZ	-
SSFH-001T-P0.5	-	-	-	-	-		-	-	EJ-SFH	-
SSFH-002T-P0.5	-	-	-	-	-		-	-	EJ-SFH	-
SSH-003T-P0.2-H	YRS-859	-	-	-	-		WC-SH2832	-	-	-
SSH-003GA-P0.2	YRS-859	-	-	-	-		WC-SH2832	-	-	-
SSHL-002T-P0.2	YRS-1140	-	-	-	-		WC-GH2630	-	-	-
SSHL-003T-P0.2	YRS-859	-	-	-	-		WC-SH2832	-	-	-
SSHL-003GA1-P0.2	YRS-859	-	-	-	-		WC-SH2832	-	-	-
SSF/M-01T-P1.4	-	YC-500	-	-	-		-	BSF/M-01T-P1.4	SLJ-1.4	ITBL-08V
SSF/M-21T-P1.4	-	YC-550	-	-	-		WC-550	BSF/M-21T-P1.4	SLJ-1.4	-
STI-01(T)-110N	-	YC-041	-	-	-		-	LTI-01(T)-110N	-	-

Note: Contact JST for wire range.

## Crimping tools

Terminals and parts model number in alphabetical order	Hand tools					Hand tools			Extraction and Insertion tools	
	for chain terminals	for loose piece terminals				for loose piece terminals			Extraction tool	Insertion tool
	YRS series	YC series	YRM series	YRF series	YRK · YRK-EX series	WC & JUC series JUC's Hand Tools	Terminal in loose form model No.			
STI-1.0-250D/N	-	-	-	-	-	-	JUCS-TI	-	-	-
STI-2.5-250D/N	-	-	-	-	-	-	JUCS-TI	-	-	-
STI-41(T)-110N	-	YC-063	-	-	-	-	-	LTI-41(T)-110N	-	-
STI-51(T)-250N	-	YC-322	-	-	-	-	-	LTI-51(T)-250N	-	-
STO-01(T)-110N(-8)	-	YC-041	-	-	-	-	-	LTO-01(T)-110N(-8)	-	-
STO-01(T)-187N(-8)	-	YC-042	-	-	-	-	-	LTO-01(T)-187N(-8)	-	-
STO-0.25-110N	-	YC-810	-	-	-	-	-	-	-	-
STO-0.5-110N	-	YC-820	-	-	-	-	JUCS-05110	-	-	-
STO-1.0-110N	-	-	-	-	-	-	JUCS-2.8/4.8	-	-	-
STO-1.0-187N	-	-	-	-	-	-	JUCS-2.8/4.8	-	-	-
STO-1.0-250N	-	-	-	-	-	-	JUCS-6.3	-	-	-
STO-2.5-250N	-	-	-	-	-	-	JUCS-6.3	-	-	-
STO-21(T)-205N	-	YC-053	-	-	-	-	-	LTO-21(T)-205N	-	-
STO-21(T)-250N	-	YC-102	-	-	-	-	-	LTO-21(T)-250N	-	-
STO-41(T)-110N(-8)	-	YC-062	-	-	-	-	-	LTO-41(T)-110N(-8)	-	-
STO-41(T)-187N(-8)	-	YC-051	-	-	-	-	-	LTO-41(T)-187N(-8)	-	-
STO-41T-187S	-	YC-064	-	-	-	-	-	LTO-41T-187S	EJ-187S	-
STO-61(T)-250N	-	YC-047	-	-	-	-	-	LTO-61(T)-250N	-	-
STO-81(T)-250N	-	YC-280	-	YRF-280	-	-	-	LTO-81(T)-250N	-	-
STS/D-002GG-P0.6	YRS-1360	-	-	-	-	-	-	-	EJ-TSD	-
SVA-41T-P1.1	-	YC-450	-	-	-	-	-	BVA-41T-P1.1	-	-
SVF-01T-1.5A	-	YC-044	-	-	-	-	-	LVF-01T-1.5A	-	-
SVF-01T-1.5N	-	YC-151	-	-	-	-	-	LVF-01T-1.5N	EJ-SV	-
SVF-01T-2.36N	-	YC-152	-	-	-	-	-	LVF-01T-2.36N	EJ-LV	-
SVF-42T-P2.0	-	YC-592	-	-	-	-	WC-592	BVF-42T-P2.0	VLJ-20	-
SVM-42T-P2.0	-	YC-593	-	-	-	-	WC-592	BVM-42T-P2.0	VLJ-20	-
SVF/M-61T-P2.0	-	YC-590	-	YRF-590	-	-	WC-590	BVF/M-61T-P2.0	VLJ-20	-
SVF/M-81T-P2.0	-	-	-	YRF-591	-	-	WC-591	BVF/M-81T-P2.0	VLJ-20	-
SVH-21T-P1.1	-	YC-160R YC-161R YC-164R	YRM-160  YRM-164	-	-	-	WC-160	BVH-21T-(P)1.1	EJ-NV	-
SVH-41T-P1.1	-	YC-930R YC-931R	-	-	-	-	WC-930	BVH-41T-P1.1	EJ-NV	-
SVT-41T-P1.1	-	YC-630	-	-	-	-	-	BVT-41T-P1.1	EJ-VT	-
SVU-21T-P0.6	-	YC-990R	-	-	-	-	-	BVU-21T-P0.6	EJ-VU4	-
SVYF-61T-P0.5A	-	-	-	YRF-536	-	-	-	-	-	-
SWPJT-21T-P0.5	-	-	-	-	-	-	-	-	EJ-WPJ	-
SWPJT-21T-P0.5A	-	-	-	-	-	-	-	-	EJ-WPJ	-
SWPJR-21T-M0.5	-	-	-	-	-	-	-	-	EJ-WPJ	-
SWPKP-21T-0.6	-	-	-	YRF-1051	-	-	-	BWPKP-21T-0.6	-	-
SWPKR-21T-0.6	-	-	-	YRF-1050	-	-	-	BWPKR-21T-0.6	-	-
SWPR-001T-P025	YRS-980	-	-	-	-	-	WC-JWPF	-	EJ-JWPF	-
SWPT-001T-P025	YRS-980	-	-	-	-	-	WC-JWPF	-	EJ-JWPF	-
SXA-01T-P0.6	YRS-701	YC-701R	-	-	-	-	WC-700M	BXA-01T-P0.6	EJ-XAG,EJ-XMP	-
SXA-001T-P0.6	YRS-692	YC-692R	-	-	-	-	-	BXA-001T-P0.6	EJ-XMP, EJ-XMR	IT-XA
SXA-001T-P0.6L	YRS-691	-	-	-	-	-	WC-691	-	-	-

Note: Contact JST for wire range.

**Crimping tools**

Terminals and parts model number in alphabetical order	Hand tools						Hand tools		Extraction and Insertion tools	
	for chain terminals	for loose piece terminals				for loose piece terminals		Extraction tool	Insertion tool	
	YRS series	YC series	YRM series	YRF series	YRK · YRK-EX series	WC & JUC series JUK's Hand Tools	Terminal in loose form model No.			
SXAM-01T-P0.6	YRS-701	YC-701R	-	-	-		WC-700M	BXAM-01T-P0.6	EJ-XAW	-
SXAM-001T-P0.6	YRS-692	YC-692R	-	-	-		-	BXAM-001T-P0.6	EJ-XAW	-
SXF-01T-P0.7	-	YC-251	-	-	-		-	BXF-01T-(P)0.7	LEJ-7	-
SXF-41T-P0.7	-	YC-252	-	-	-		-	BXF-41T-(P)0.7	LEJ-7	-
SXH-001T-P0.6	YRS-110	YC-110R YC-111R	-	-	-		WC-110	BXH-001T-P0.6	XJ-06	-
SXH-001T-P0.6N	-	-	-	-	-		-	-	XJ-06	-
SXH-002T-P0.6	YRS-480	-	-	-	-		-	-	XJ-06	-
SXM-01T-P0.6	YRS-701	YC-701R	-	-	-		-	BXM-01T-P0.6	EJ-XAG,EJ-XMP	-
SXM-001T-P0.6	YRS-692	YC-692R	-	-	-		-	BXM-001T-P0.6	EJ-XMP, EJ-XMR	IT-XA
SXNI-001T-P0.6	YRS-1380	-	-	-	-		-	-	-	-
SXNI-003T-P0.6	YRS-1390	-	-	-	-		-	-	-	-
SYF-001T-P0.6	YRS-125	-	-	-	-		-	-	-	-
SYF/M-01T-P0.5A	-	YC-520	-	-	-		WC-520	BYF/M-01T-P0.5A	YLJ-0.5	-
SYF/M-41T-P0.5A	-	YC-530	-	-	-		WC-530	BYF/M-41T-P0.5A	YLJ-0.5	-
SYF-61T-P0.5A	-	-	-	YRF-536	-		-	-	-	-
SYM-001T-P0.6	YRS-121	YC-121R	-	-	-		WC-121	BYM-001T-P0.6	SMJ-06	-
SYM-01T-P0.7	-	YC-251	-	-	-		-	BYM-01T-(P)0.7	LEJ-7	-
SYM-41T-P0.7	-	YC-252	-	-	-		-	BYM-41T-(P)0.7	LEJ-7	-
SZE-002T-P0.3	YRS-1300	-	-	-	-		-	-	-	-
SZE-003T-P0.3	YRS-1330	-	-	-	-		-	-	-	-
SZF/M-01T-P0.7	-	YC-390R	-	-	-		-	BZF/M-01T-(P)0.7	ZLJ-07S	-
SZF/M-41T-P0.7	-	YC-380R	-	-	-		-	BZF/M-41T-(P)0.7	ZLJ-07S	-
SZH-002T-P0.5	YRS-491	-	-	-	-		WC-491	-	-	-
SZH-003T-P0.5	YRS-490	-	-	-	-		WC-490	-	-	-
SZN-002T-P0.7K	YRS-541	-	-	-	-		-	-	-	-
SZN-003T-P0.7K	YRS-540	-	-	-	-		-	-	-	-
SZPD-002T-P0.3	YRS-1460	-	-	-	-		-	-	-	-

Note: Contact JST for wire range.

## YRK series hand crimping tools suitable for mass-production

- Crimping work, such as setting contacts to hand tools etc., is facilitated by using a strip contact to improve the productivity.
- A light operation enables to terminate the contact correctly, by adopting straight-ahead crimping.
- A structure, that the carrier of contact doesn't fly off, has been adopted to this tool.

### Hand Crimping Tools YRK Standard type

- When exchanging the crimper, the crimping suitable for the wire specification can be conducted.
- Anvil is fixed to tool.



Dimensions: 75(W)×314(L)×25(D)mm  
Weight: Approx. 800g (When assembling dies)

### Contact and Applicable dies

Series	Nominal	Contact Model No.		Hand crimp tools	Model No. of crimper <sup>*1</sup>	Applicable wire size		
		Receptacle	Tab			Marking	AWG	Insulation O.D. (mm)
J1000 Type II	L	SF1F-21 (*) -P0.6	SF1M-21 (*) -M0.6A	YRK-1210	LA / LB	LA	#22	1.58
						LB	KV0.75	1.90
					LC / LD	LC	#20	1.76
						LD	#18	2.03
J2000	S	SJ2F-002GF-P1.0	SJ2M-002GF-M1.0N	YRK-8851	SA / SB	SA	#28	1.20
						SB	#24	1.43
	M	SJ2F-01GF-P1.0	SJ2M-01GF-M1.0N	YRK-8861	MA / MB	MA	#24	1.43
						MB	#20	1.53 <sup>*2</sup>
L	SJ2F-21GF-P1.0	SJ2M-21GF-M1.0N	YRK-1120	LA / LB	LA	#22	1.58	
					LB	#20	1.76	
J300	S	SF3F-002 (*) -P2.0	—	YRK-8821	SA / SB	SA	#28	1.20
						SB	#24	1.43
					SC / SD	SC	#26	1.30
						SD	#24	1.11
	M	SF3F-01 (*) -P2.0	SF3M-01 (*) -M2.0N	YRK-8811	MA / MB	MA	#24	1.43
						MB	#20	1.76
					MC / MD	MC	#22	1.58
						MD	#20	2.56
	L	SF3F-41 (*) -P2.0	SF3M-41 (*) -M2.0N	YRK-8801	LA / LB	LA	#20	1.76
						LB	#16	2.35
					LC / LD	LC	#18	2.03
						LD	#18	2.83
2L	SF3F-71 (*) -P2.0	SF3M-71 (*) -M2.0N	YRK-1071	2LA / 2LB	2LA	#16	3.10	
					2LB	#14	3.30	

Note: 1. J1000 Finish(\*): T..... Tin-plated  
GC... Gold-plated  
2. J300 Finish(\*): GF... Nickel-undercoated, 0.38μm selective gold-plated  
GI... Nickel-undercoated, 0.76μm selective gold-plated  
T..... Tin-plated

3. The wear of parts is caused by using hand tool repeatedly.  
Measure the crimping height daily and conduct periodical inspection of the wearing parts, such as ratchet, pin and so on.

\*1... Crimper is either the pair of A and B or the pair of C and D.  
\*2... When using wire type UL 2517.

## Dies replacement type hand crimping tools

### YRK-EX

- High reliability of crimping is provided by choosing the crimper and anvil suitable for the wire specification.
- The crimping die can be easily exchanged by only insertion and extraction of pin.
- Common handle and crimping dies can be stored in One case and it is easy to carry.

Patent pending



Dimensions: 75(W)×314(L)×25(D)mm  
Weight: Approx. 800g (When assembling dies)



Dimensions: 376(W)×295(L)×73(D)mm

### Contact and Applicable dies

Series	Nominal	Contact Model No.		Crimper Model No.	Crimper <sup>*1</sup>			Anvil	Color mark	Common parts
		Receptacle	Tab		Die mark	AWG	Insulation O.D. (mm)			
J1000 Type II	L	SF1F-21(*)-P0.6	SF1M-21(*)-M0.6A	J1LA / B	A	#20	1.76	J1LL	Yellow green	Handle unit Upper pin Lower pin Case
					B	#18	2.03			
					C	#22	1.58			
					D	KV0.75	1.90			
J2000	S	SJ2F-002GF-P1.0	SJ2M-002GF-M1.0N	J2SA / B	A	#28	1.20	J2SL	White	
					B	#24	1.43			
	M	SJ2F-01GF-P1.0	SJ2M-01GF-M1.0N	J2MA / B	A	#24	1.43	J2ML	Purple	
					B	#20	1.53 <sup>*2</sup>			
	L	SJ2F-21GF-P1.0	SJ2M-21GF-M1.0N	J2LA / B	A	#22	1.58	J2LL	Orange	
					B	#20	1.76			
J300	S	SF3F-002 (*) -P2.0	—	J3SA / B	A	#28	1.20	J3SL	Yellow	
					B	#24	1.43			
				J3SC / D	C	#26	1.30			
					D	#24	1.11			
	M	SF3F-01 (*) -P2.0	SF3M-01 (*) -M2.0N	J3MA / B	A	#24	1.43	J3ML	Green	
					B	#20	1.76			
				J3MC / D	C	#22	1.58			
					D	#20	2.56			
	L	SF3F-41 (*) -P2.0	SF3M-41 (*) -M2.0N	J3LA / B	A	#20	1.76	J3LL	Red	
					B	#16	2.35			
				J3LC / D	C	#18	2.03			
					D	#18	2.83			
2L	SF3F-71 (*) -P2.0	SF3M-71 (*) -M2.0N	J32LA / B	A	#16	3.10	J32LL	Blue		
				B	#14	3.30				

Note: 1. J1000 Finish(\*): T..... Tin-plated  
GC... Gold-plated  
2. J300 Finish(\*): GF... Nickel-undercoated, 0.38μm selective gold-plated  
GI... Nickel-undercoated, 0.76μm selective gold-plated  
T..... Tin-plated

3. The wear of parts is caused by using hand tool repeatedly.  
Measure the crimping height daily and conduct periodical inspection of the wearing parts, such as ratchet, pin and so on.

\*1... Crimper is either the pair of A and B or the pair of C and D.  
\*2... When using wire type UL 2517.



Компания «Океан Электроники» предлагает заключение долгосрочных отношений при поставках импортных электронных компонентов на взаимовыгодных условиях!

Наши преимущества:

- Поставка оригинальных импортных электронных компонентов напрямую с производств Америки, Европы и Азии, а так же с крупнейших складов мира;
- Широкая линейка поставок активных и пассивных импортных электронных компонентов (более 30 млн. наименований);
- Поставка сложных, дефицитных, либо снятых с производства позиций;
- Оперативные сроки поставки под заказ (от 5 рабочих дней);
- Экспресс доставка в любую точку России;
- Помощь Конструкторского Отдела и консультации квалифицированных инженеров;
- Техническая поддержка проекта, помощь в подборе аналогов, поставка прототипов;
- Поставка электронных компонентов под контролем ВП;
- Система менеджмента качества сертифицирована по Международному стандарту ISO 9001;
- При необходимости вся продукция военного и аэрокосмического назначения проходит испытания и сертификацию в лаборатории (по согласованию с заказчиком);
- Поставка специализированных компонентов военного и аэрокосмического уровня качества (Xilinx, Altera, Analog Devices, Intersil, Interpoint, Microsemi, Actel, Aeroflex, Peregrine, VPT, Syfer, Eurofarad, Texas Instruments, MS Kennedy, Miteq, Cobham, E2V, MA-COM, Hittite, Mini-Circuits, General Dynamics и др.);

Компания «Океан Электроники» является официальным дистрибьютором и эксклюзивным представителем в России одного из крупнейших производителей разъемов военного и аэрокосмического назначения «JONHON», а так же официальным дистрибьютором и эксклюзивным представителем в России производителя высокотехнологичных и надежных решений для передачи СВЧ сигналов «FORSTAR».



## JONHON

«JONHON» (основан в 1970 г.)

Разъемы специального, военного и аэрокосмического назначения:

(Применяются в военной, авиационной, аэрокосмической, морской, железнодорожной, горно- и нефтедобывающей отраслях промышленности)

«FORSTAR» (основан в 1998 г.)

ВЧ соединители, коаксиальные кабели, кабельные сборки и микроволновые компоненты:

(Применяются в телекоммуникациях гражданского и специального назначения, в средствах связи, РЛС, а так же военной, авиационной и аэрокосмической отраслях промышленности).



Телефон: 8 (812) 309-75-97 (многоканальный)

Факс: 8 (812) 320-03-32

Электронная почта: [ocean@oceanchips.ru](mailto:ocean@oceanchips.ru)

Web: <http://oceanchips.ru/>

Адрес: 198099, г. Санкт-Петербург, ул. Калинина, д. 2, корп. 4, лит. А