

High-performance Regulator IC Series for PCs

300mA Linear Regulators for Desktop PC



BD35613HFV/EFJ/HFN, BD35615HFV/EFJ/HFN, BD35618HFV/EFJ/HFN

●Description

BD3561□ series is a LDO regulator with output current 300mA. The output accuracy is $\pm 1\%$ of output voltage. BD3561□ series has some kinds of output voltage line-up and package line-up. Thus, it is used for the wide applications of digital appliances. Over current protection (for protecting the IC destruction by output short circuit), shutdown ON/OFF switch (for setting the circuit current $0\mu\text{A}$ at shutdown mode), and thermal shutdown circuit (for protecting ICs from heat destruction by over load condition) are all built in.

●Features

- 1) Output current 300mA
- 2) Output voltage accuracy : $\pm 1\%$
- 3) Built-in Over Current Protection circuit (OCP)
- 4) Built-in Thermal Shut Down circuit (TSD)
- 5) With shut down switch
- 6) Rich package line-up : HSON8, HTSOP-J8, HVSO6

●Line-up

Product name	8.0V	5.0V	3.3V	Package
BD3561□HFN	○	○	○	HSON8
BD3561□EFJ	○	○	○	HTSOP-J8
BD3561□HFV	○	○	○	HVSO6

Product name : BD3561□ □□□
 ↑ ↑
 a b

Symbol			
a		b	
1□	Output Voltage (V)	□□□	Package
18	8.0V typ.	HFN	HSON8
15	5.0V typ.	EFJ	HTSOP-J8
13	3.3V typ.	HFV	HVSO6

● Absolute maximum ratings (Ta=25°C)

Parameter	Symbol	Limits	Unit
Power Supply Voltage	Vcc	15.0 * ¹	V
EN Voltage	VEN	15.0	V
Power Dissipation	HSO8	1350 * ²	mW
	HTSOP-J8	2110 * ³	
	HVSOF6	850.0 * ⁴	
Operating Temperature Range	Topr	-10~+100	°C
Storage Temperature Range	Tstg	-55~+150	°C
Junction Temperature	Tjmax	+150	°C

*1 Not to exceed Pd

*2 Reduced by 10.8mW for each increase in Ta of 1°C over 25°C.

(when mounted on a board 70.0mm × 70mm × 1.6mm Glass-epoxy PCB. (copper foil area:100mm²))

*3 Reduced by 16.9mW for each increase in Ta of 1°C over 25°C.

(when mounted on a board 70.0mm × 70mm × 1.6mm Glass-epoxy PCB, 2 layer)

*4 Reduced by 6.8mW for each increase in Ta of 1°C over 25°C.

(when mounted on a board 70.0mm × 70mm × 1.6mm Glass-epoxy PCB. (copper foil area:100mm²))

● Operating Conditions (Ta=25°C)

Parameter	Symbol	Min.	Max.	Unit
Input Power Supply Voltage	VCC	Vo+1.8	14.0	V
EN Voltage	VEN	-	14.0	V
Output Current	Io	-	300	mA

★ This product should not be used in a radioactive environment.

● ELECTRICAL CHARACTERISTICS

BD3561 □ HFN/EFJ/HFV (Unless otherwise noted, Ta=25°C, EN=3V, Vcc=12V)

Parameter	Symbol	Min.	Typ.	Max.	Unit	Conditions
Output Voltage 1	Vo1	Vo(T) × 0.99	Vo(T)	Vo(T) × 1.01	V	Io=0mA
Output Voltage 2	Vo2	Vo(T) × 0.985	Vo(T)	Vo(T) × 1.015	V	Tj=0 to 100°C Io=0mA→300mA
Circuit Current at shutdown mode	Isd	-	0	5	μA	EN=0V, @OFF mode
Bias Current	Icc	-	200	300	μA	
Output Current Ability	Io	300	-	-	mA	
Line Regulation	Reg.I	-	25	50	MV	Vcc=(Vo+1.8V)→14.0V, Io=300mA
EN Low Voltage	VEN (Low)	0	-	0.8	V	
EN High Voltage	VEN (High)	2.4	-	14.0	V	
EN Bias Current	IEN	0.5	1.0	5.0	μA	

● Reference Data

BD35618HFV (Unless otherwise specified, $T_a=25^\circ\text{C}$, $V_{EN}=3\text{V}$, $V_{CC}=12\text{V}$)

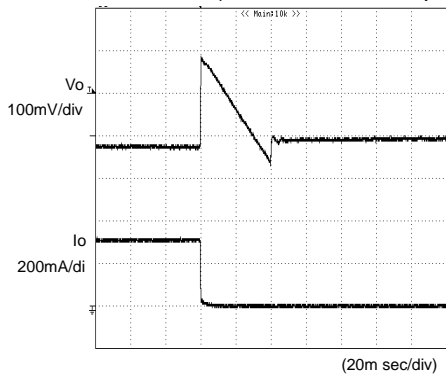

Fig.1 Transient Response
(50→0mA)
 $C_o=1\ \mu\text{F}$

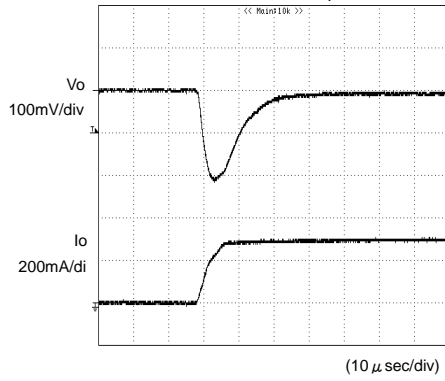

Fig.2 Transient Response
(0→50mA)
 $C_o=1\ \mu\text{F}$

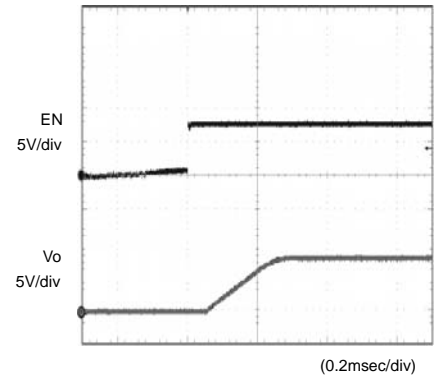

Fig.3 Waveform at output start
 $C_o=1\ \mu\text{F}$

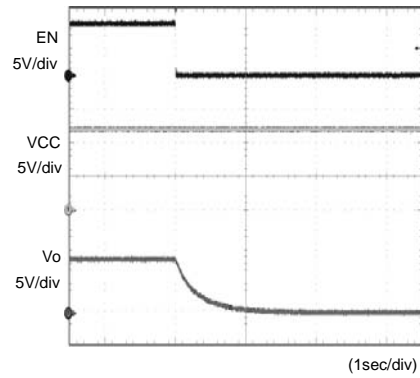

Fig.4 Waveform at output OFF
 $C_o=1\ \mu\text{F}$

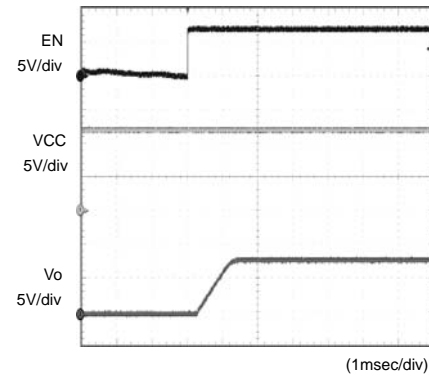

Fig.5 Input sequence 1
 $C_o=1\ \mu\text{F}$

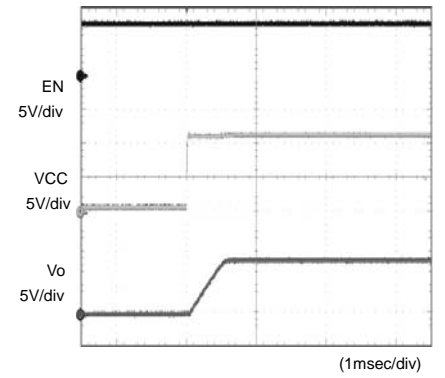

Fig.6 Input sequence 2
 $C_o=1\ \mu\text{F}$

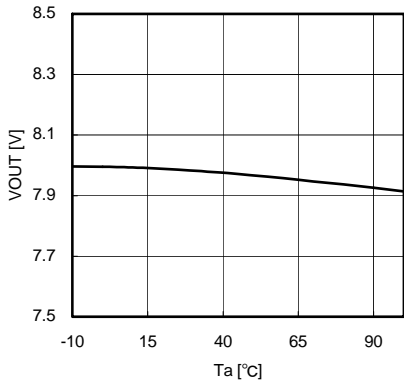

Fig.7 T_a - V_o ($I_o=0\text{mA}$)

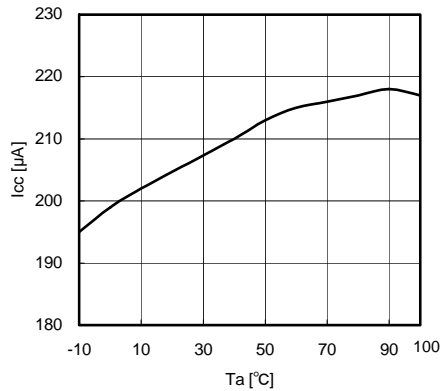

Fig.8 T_a - I_{CC}
($V_{EN}=12\text{V}$)

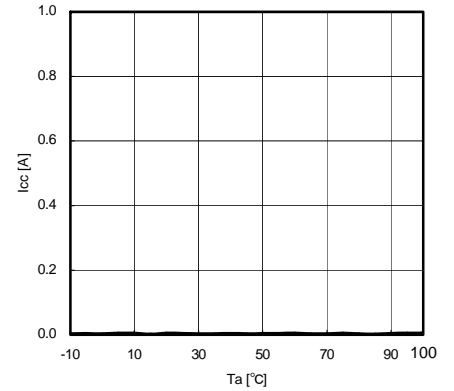

Fig.9 T_a - I_{CC}
($V_{CC}=12\text{V}$, $V_{EN}=0\text{V}$)

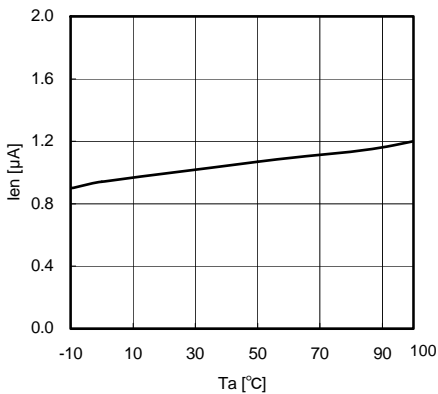

Fig.10 T_a - I_{EN}
($V_{CC}=12\text{V}$, $V_{EN}=3\text{V}$)

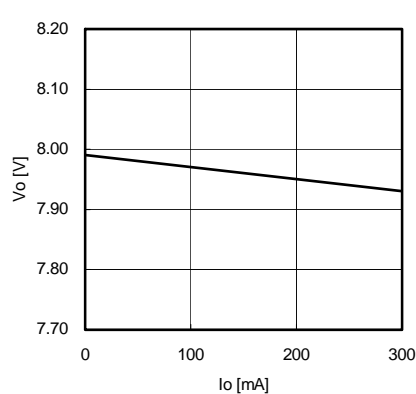

Fig.11 I_o - V_o

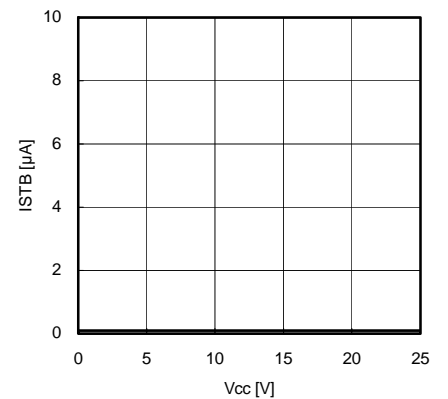

Fig.12 V_{CC} - I_{STB}
($V_{CC}=12\text{V}$, $V_{EN}=3\text{V}$)

●Reference Data

BD35618HFV (Unless otherwise specified, Ta=25°C, EN=3V, Vcc=12V)

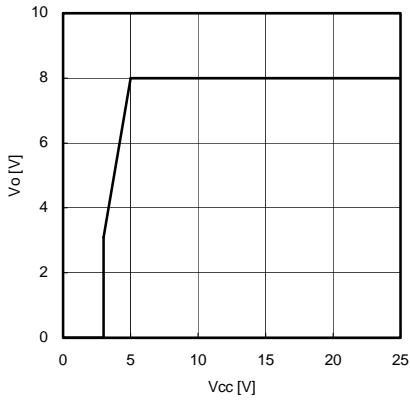
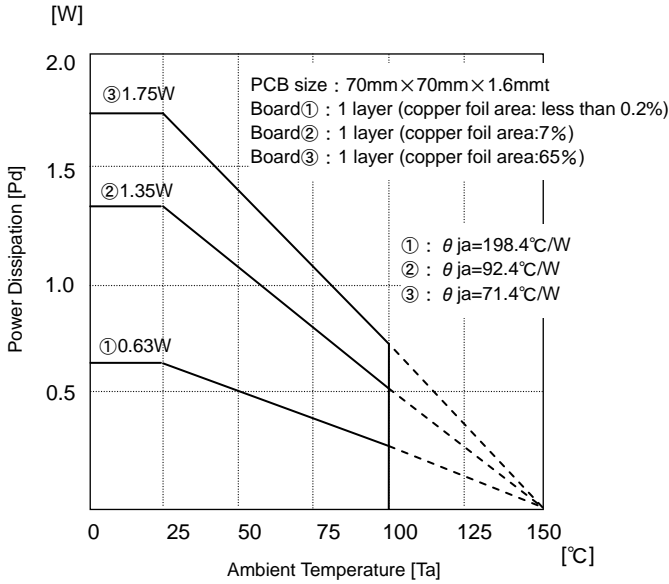

Fig.13 Vcc-Vo

●Heat Dissipation Characteristics

◎HSON8



◎HTSOP-J8

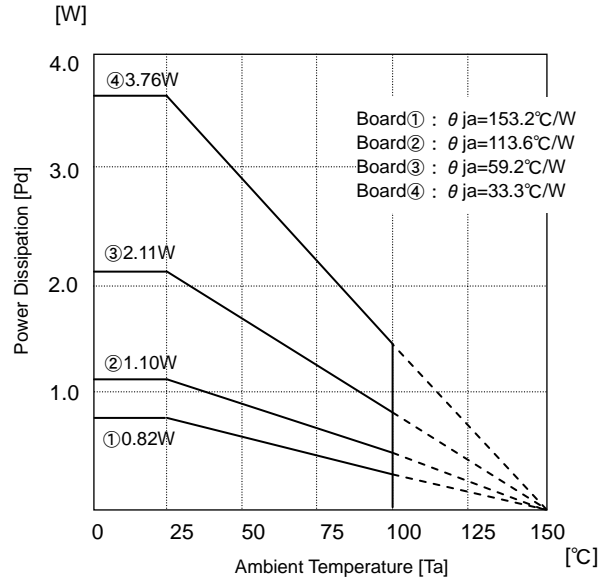

◎HVSOF6

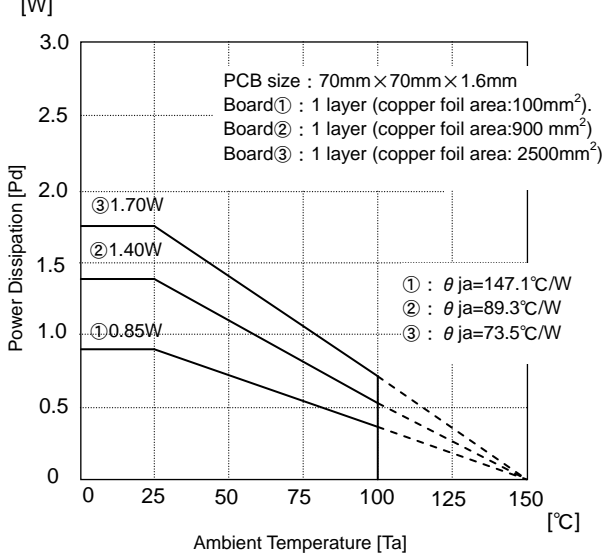

●Block Diagram

(HSON8, HTSOP-J8)

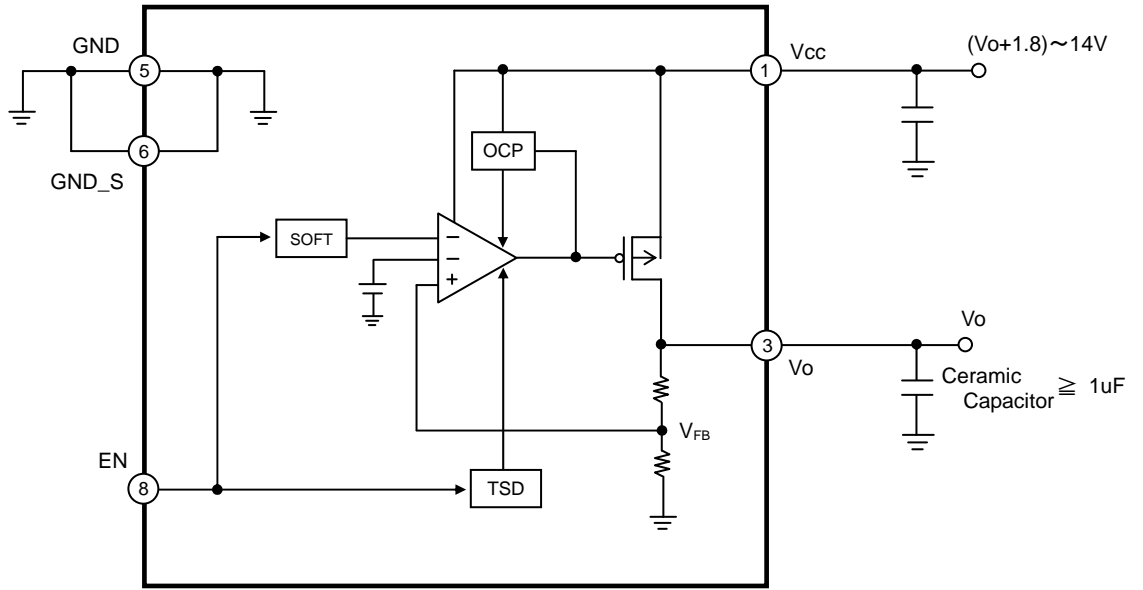

(HVSOF6)

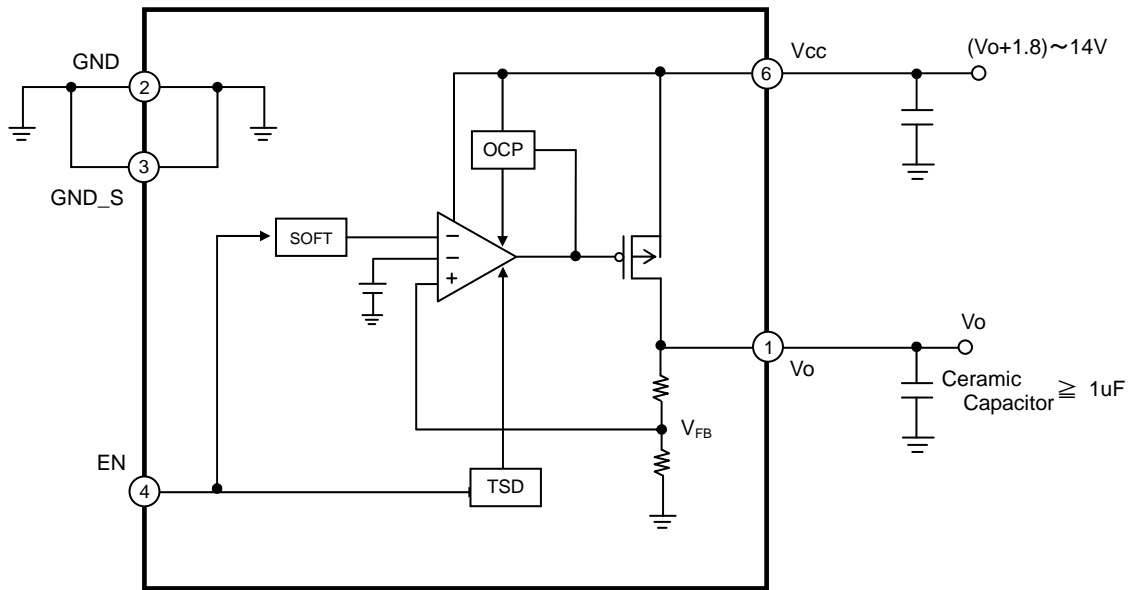

● Pin Function Table (HSON8, HTSOP-J8)

Pin No.	Pin name	Pin Function
1	Vcc	Input Voltage Pin
2	N.C.	Open
3	Vo	Output Voltage Pin
4	N.C.	Open
5	GND	GND Pin
6	GND_S	GND Sense Pin
7	N.C.	Open
8	EN	Enable Pin

(HVSOF6)

Pin No.	Pin name	Pin Function
1	Vo	Output Voltage Pin
2	GND	GND Pin
3	GND_S	GND Sense Pin
4	EN	Enable Pin
5	N.C	Open
6	Vcc	Input Voltage Pin

● Pin Layout (HSON8, HTSOP-J8)

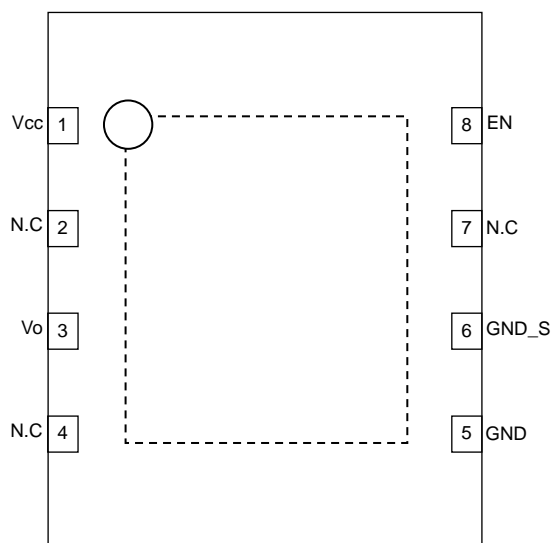

(HVSOF6)

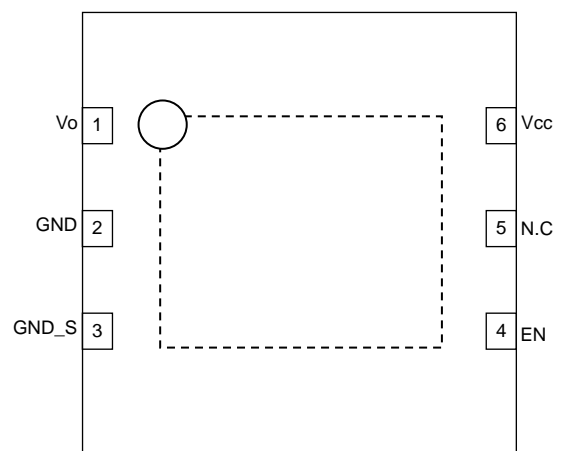

●Evaluation Board Circuit (Vo=8.0V)

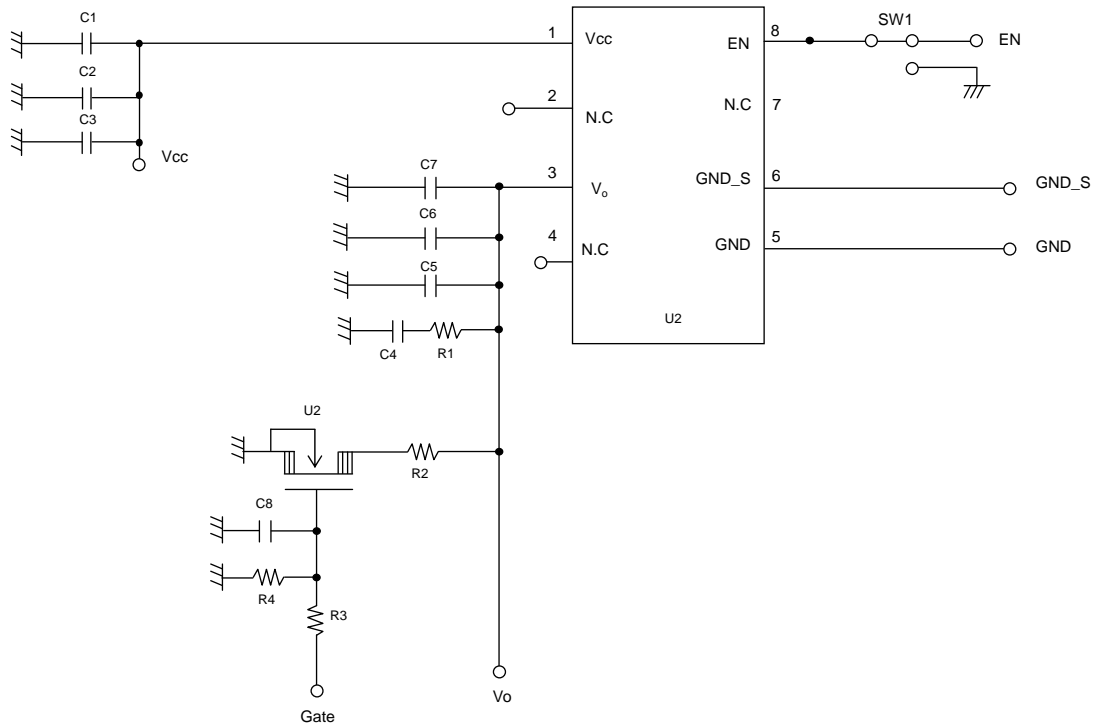

●Evaluation Board Parts List

Designation	Value	Part No.	Company
R1	-	-	-
R2	-	-	-
R3	-	-	-
R4	-	-	-
C1	-	-	-
C2	1uF	CM105B105K10A	KYOCERA
C3	-	-	-
C4	-	-	-
C5	-	-	-
C6	1uF	CM105B105K16A	KYOCERA
C7	-	-	-
C8	-	-	-
U1	-	BD3561XHFV	ROHM
U2	-	-	-

●Reference landing pattern
 ©HSON8

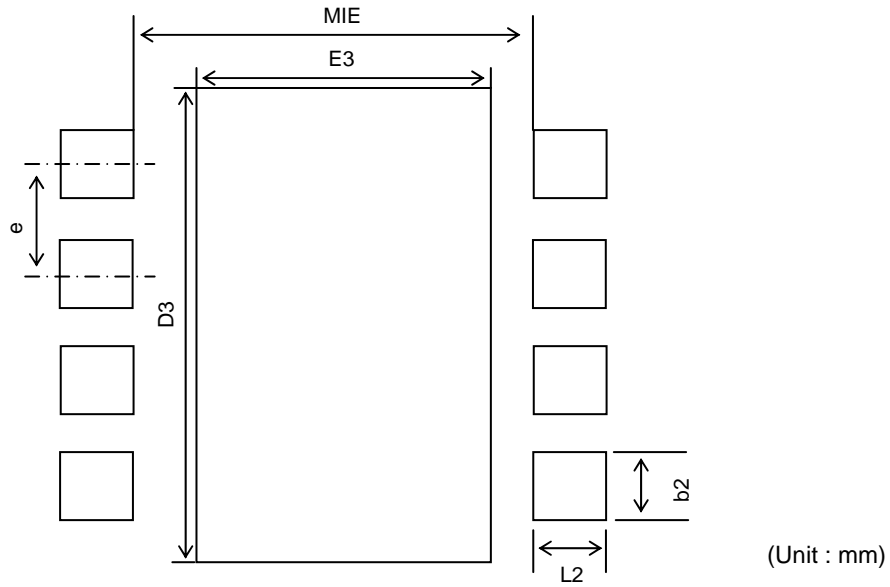

Lead pitch e	landing pitch MIE	landing length ≥l2	landing pitc b2
0.65	2.50	0.40	0.35
central pad length D3	central pad pitch E3		
2.90	1.90		

*It is recommended to design suitable for the actual application.

©HVSOF6

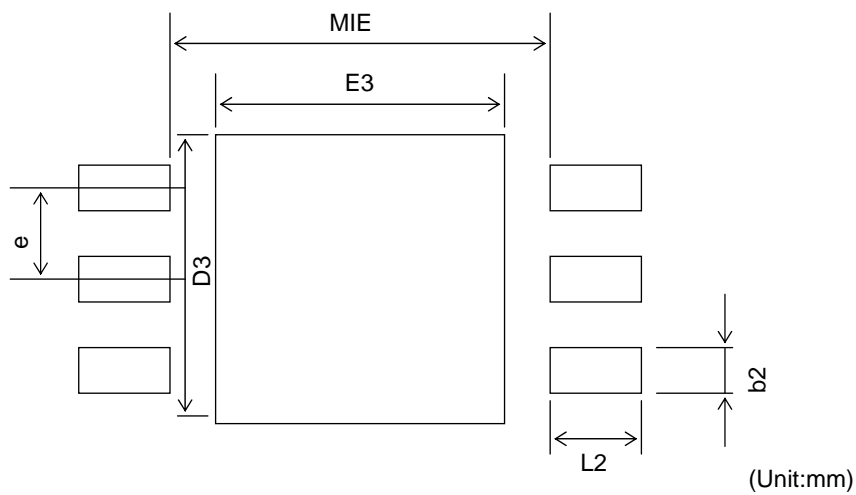

Lead pitch e	landing pitch MIE	landing length l2	landing pitch b2
0.50	3.00	0.55	0.25

central pad length D3	central pad pitch E3
1.60	2.60

*It is recommended to design suitable for the actual application.

● Operation Notes

1. Absolute maximum ratings

An excess in the absolute maximum ratings, such as supply voltage, temperature range of operating conditions, etc., can break down the devices, thus making impossible to identify breaking mode, such as a short circuit or an open circuit. If any over rated values will expect to exceed the absolute maximum ratings, consider adding circuit protection devices, such as fuses.

2. Connecting the power supply connector backward

Connecting of the power supply in reverse polarity can damage IC. Take precautions when connecting the power supply lines. An external direction diode can be added.

3. Power supply lines

Design PCB layout pattern to provide low impedance GND and supply lines. To obtain a low noise ground and supply line, separate the ground section and supply lines of the digital and analog blocks. Furthermore, for all power supply terminals to ICs, connect a capacitor between the power supply and the GND terminal. When applying electrolytic capacitors in the circuit, not that capacitance characteristic values are reduced at low temperatures.

4. GND voltage

The potential of GND pin must be minimum potential in all operating conditions.

5. Thermal design

Use a thermal design that allows for a sufficient margin in light of the power dissipation (Pd) in actual operating conditions.

6. Inter-pin shorts and mounting errors

Use caution when positioning the IC for mounting on printed circuit boards. The IC may be damaged if there is any connection error or if pins are shorted together.

7. Actions in strong electromagnetic field

Use caution when using the IC in the presence of a strong electromagnetic field as doing so may cause the IC to malfunction.

8. ASO

When using the IC, set the output transistor so that it does not exceed absolute maximum ratings or ASO.

9. Thermal shutdown circuit

The IC incorporates a built-in thermal shutdown circuit (TSD circuit). The thermal shutdown circuit (TSD circuit) is designed only to shut the IC off to prevent thermal runaway. It is not designed to protect the IC or guarantee its operation. Do not continue to use the IC after operating this circuit or use the IC in an environment where the operation of this circuit is assumed.

	TSD on temperature [°C] (typ.)	Hysteresis temperature [°C] (typ.)
BD3561XHFN/EFJ/HFV	175	15

10. Testing on application boards

When testing the IC on an application board, connecting a capacitor to a pin with low impedance subjects the IC to stress. Always discharge capacitors after each process or step. Always turn the IC's power supply off before connecting it to or removing it from a jig or fixture during the inspection process. Ground the IC during assembly steps as an antistatic measure. Use similar precaution when transporting or storing the IC.

11. Regarding input pin of the IC

This monolithic IC contains P+ isolation and P substrate layers between adjacent elements in order to keep them isolated. P-N junctions are formed at the intersection of these P layers with the N layers of other elements, creating a parasitic diode or transistor. For example, the relation between each potential is as follows:

When $GND > Pin A$ and $GND > Pin B$, the P-N junction operates as a parasitic diode.

When $GND > Pin B$, the P-N junction operates as a parasitic transistor.

Parasitic diodes can occur inevitable in the structure of the IC. The operation of parasitic diodes can result in mutual interference among circuits, operational faults, or physical damage. Accordingly, methods by which parasitic diodes operate, such as applying a voltage that is lower than the GND (P substrate) voltage to an input pin, should not be used.

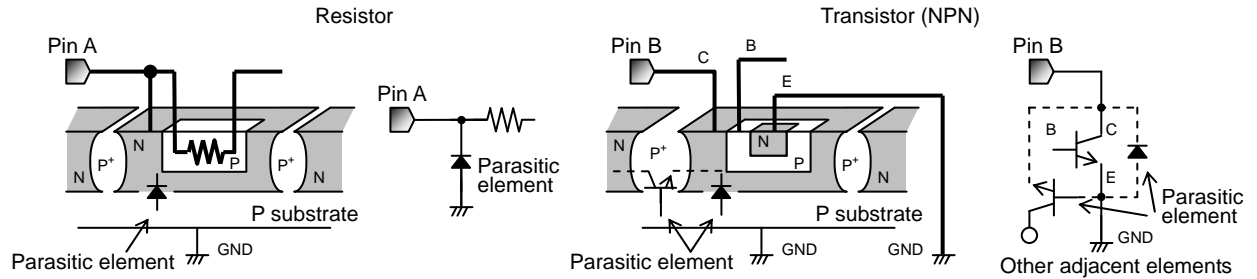

12. Ground Wiring Pattern.

When using both small signal and large current GND patterns, it is recommended to isolate the two ground patterns, placing a single ground point at the ground potential of application so that the pattern wiring resistance and voltage variations caused by large currents do not cause variations in the small signal ground voltage. Be careful not to change the GND wiring pattern of any external components, either.

●Type Designations (Ordering Information)

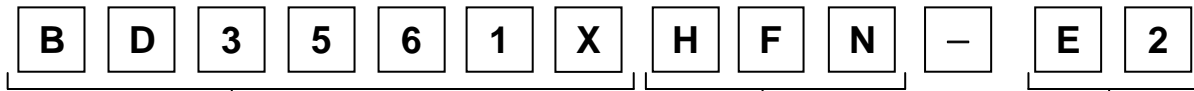

Product Name

- BD35618
- BD35615
- BD35613

Package Type

- HFN : HSON8
- EFJ : HTSOP-J8
- HFV : HVSOF6

E2 Emboss tape reel opposite draw-out side: 1 pin
TR Emboss tape reel opposite draw-out side: 1 pin

HSON8

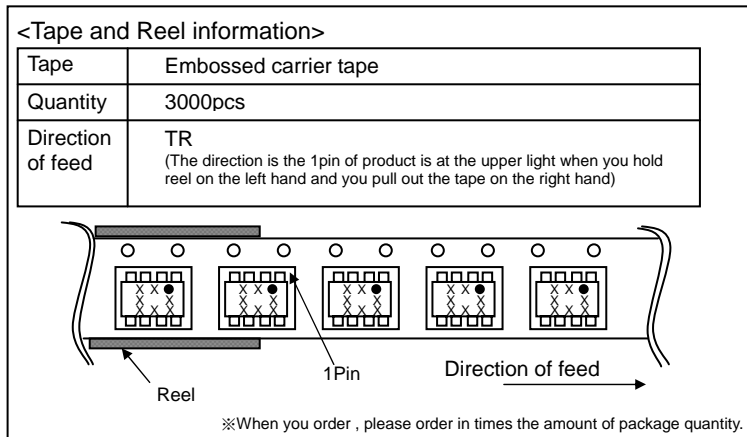
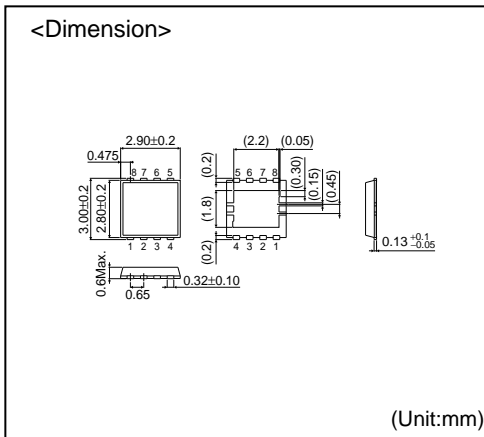

HVSOF6

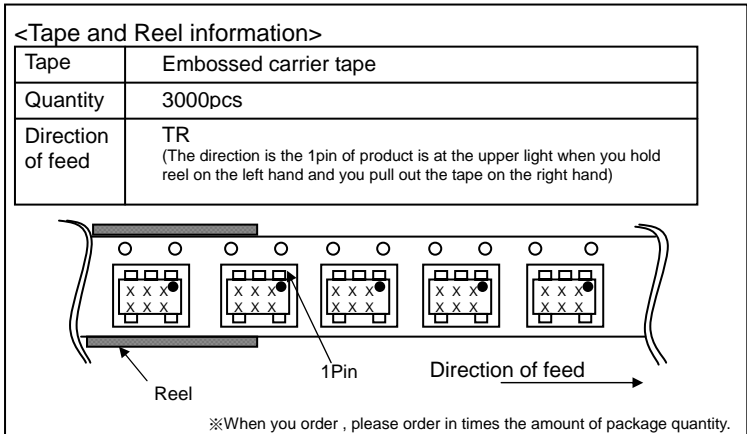
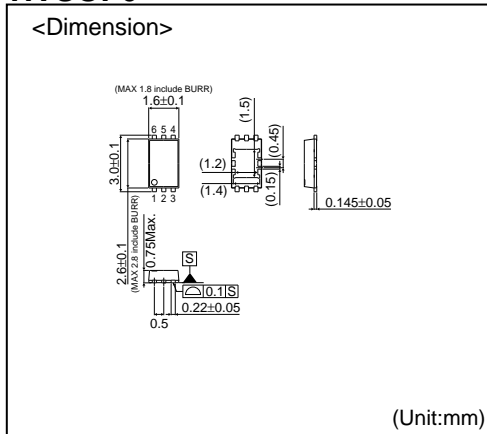

HTSOP-J8

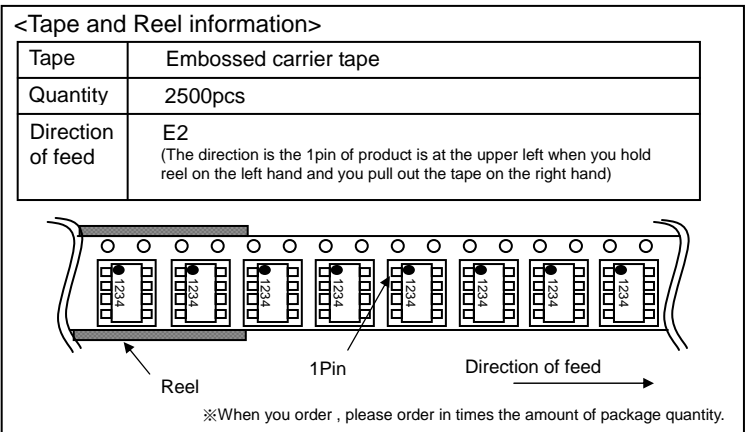
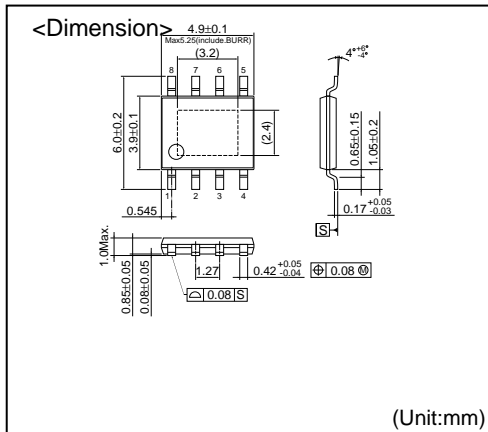

- The contents described herein are correct as of October, 2008
- The contents described herein are subject to change without notice. For updates of the latest information, please contact and confirm with ROHM CO.,LTD.
- Any part of this application note must not be duplicated or copied without our permission.
- Application circuit diagrams and circuit constants contained herein are shown as examples of standard use and operation. Please pay careful attention to the peripheral conditions when designing circuits and deciding upon circuit constants in the set.
- Any data, including, but not limited to application circuit diagrams and information, described herein are intended only as illustrations of such devices and not as the specifications for such devices. ROHM CO.,LTD. disclaims any warranty that any use of such devices shall be free from infringement of any third party's intellectual property rights or other proprietary rights, and further, assumes no liability of whatsoever nature in the event of any such infringement, or arising from or connected with or related to the use of such devices.
- Upon the sale of any such devices, other than for buyer's right to use such devices itself, resell or otherwise dispose of the same, implied right or license to practice or commercially exploit any intellectual property rights or other proprietary rights owned or controlled by ROHM CO., LTD. is granted to any such buyer.
- The products described herein utilize silicon as the main material.
- The products described herein are not designed to be X ray proof.

The products listed in this catalog are designed to be used with ordinary electronic equipment or devices (such as audio visual equipment, office-automation equipment, communications devices, electrical appliances and electronic toys). Should you intend to use these products with equipment or devices which require an extremely high level of reliability and the malfunction of which would directly endanger human life (such as medical instruments, transportation equipment, aerospace machinery, nuclear-reactor controllers, fuel controllers and other safety devices), please be sure to consult with our sales representative in advance.

Contact us for further information about the products.

San Diego	TEL: +1-858-625-3630	FAX: +1-858-625-3670	Tianjin	TEL: +86-22-23029181	FAX: +86-22-23029183
Atlanta	TEL: +1-770-754-5972	FAX: +1-770-754-0691	Shanghai	TEL: +86-21-6279-2727	FAX: +86-21-6247-2066
Boston	TEL: +1-978-371-0382	FAX: +1-928-438-7164	Hangzhou	TEL: +86-571-87658072	FAX: +86-571-87658071
Chicago	TEL: +1-847-368-1006	FAX: +1-847-368-1008	Nanjing	TEL: +86-25-8689-0015	FAX: +86-25-8689-0393
Dallas	TEL: +1-469-287-5366	FAX: +1-469-362-7973	Ningbo	TEL: +86-574-87654201	FAX: +86-574-87654208
Denver	TEL: +1-303-708-0908	FAX: +1-303-708-0858	Qingdao	TEL: +86-532-5779-312	FAX: +86-532-5779-653
Detroit	TEL: +1-248-348-9920	FAX: +1-248-348-9942	Suzhou	TEL: +86-510-82702693	FAX: +86-510-82702992
Nashville	TEL: +1-615-620-6700	FAX: +1-615-620-6702	Wuxi	TEL: +86-510-82702693	FAX: +86-510-82702992
Mexico	TEL: +52-33-3123-2001	FAX: +52-33-3123-2002	Shenzhen	TEL: +86-755-8307-3008	FAX: +86-755-8307-3003
Düsseldorf	TEL: +49-2154-9210	FAX: +49-2154-921400	Dongguan	TEL: +86-769-8393-3320	FAX: +86-769-8398-4140
Munich	TEL: +49-8999-216168	FAX: +49-8999-216176	Fuzhou	TEL: +86-591-8801-8698	FAX: +86-591-8801-8690
Stuttgart	TEL: +49-711-7272-370	FAX: +49-711-7272-3720	Guangzhou	TEL: +86-20-3878-8100	FAX: +86-20-3825-5965
France	TEL: +33-1-5697-3060	FAX: +33-1-5697-3080	Huizhou	TEL: +86-752-205-1054	FAX: +86-752-205-1059
United Kingdom	TEL: +44-1-908-306700	FAX: +44-1-908-235788	Xiamen	TEL: +86-592-238-5705	FAX: +86-592-239-8380
Denmark	TEL: +45-3694-4739	FAX: +45-3694-4789	Zhuhai	TEL: +86-756-3232-480	FAX: +86-756-3232-460
Espoo	TEL: +358-9725-54491	FAX: +358-9-7255-4499	Hong Kong	TEL: +852-2-740-6262	FAX: +852-2-375-8971
Salo	TEL: +358-2-7332234	FAX: +358-2-7332237	Taipei	TEL: +886-2-2500-6956	FAX: +886-2-2503-2869
Oulu	TEL: +358-8-5372930	FAX: +358-8-5372931	Kaohsiung	TEL: +886-7-237-0881	FAX: +886-7-238-7332
Barcelona	TEL: +34-9375-24320	FAX: +34-9375-24410	Singapore	TEL: +65-6332-2322	FAX: +65-6332-5662
Hungary	TEL: +36-1-4719338	FAX: +36-1-4719339	Philippines	TEL: +63-2-807-6872	FAX: +63-2-809-1422
Poland	TEL: +48-22-5757213	FAX: +48-22-5757001	Thailand	TEL: +66-2-254-4890	FAX: +66-2-256-6334
Russia	TEL: +7-495-739-41-74	FAX: +7-495-739-41-74	Kuala Lumpur	TEL: +60-3-7958-8355	FAX: +60-3-7958-8377
Seoul	TEL: +82-2-8182-700	FAX: +82-2-8182-715	Penang	TEL: +60-4-2286453	FAX: +60-4-2286452
Masan	TEL: +82-55-240-6234	FAX: +82-55-240-6236	Kyoto	TEL: +81-75-365-1218	FAX: +81-75-365-1228
Dalian	TEL: +86-411-8230-8549	FAX: +86-411-8230-8537	Yokohama	TEL: +81-45-476-2290	FAX: +81-45-476-2295
Beijing	TEL: +86-10-8525-2483	FAX: +86-10-8525-2489			

Excellence in Electronics

ROHM

ROHM CO., LTD.

21 Saiin Mizosaki-cho, Ukyo-ku, Kyoto
615-8585, Japan
TEL: +81-75-311-2121 FAX: +81-75-315-0172
URL: <http://www.rohm.com>

Published by
KTC LSI Development Headquarters
LSI Business Promotion Group

Компания «Океан Электроники» предлагает заключение долгосрочных отношений при поставках импортных электронных компонентов на взаимовыгодных условиях!

Наши преимущества:

- Поставка оригинальных импортных электронных компонентов напрямую с производств Америки, Европы и Азии, а так же с крупнейших складов мира;
- Широкая линейка поставок активных и пассивных импортных электронных компонентов (более 30 млн. наименований);
- Поставка сложных, дефицитных, либо снятых с производства позиций;
- Оперативные сроки поставки под заказ (от 5 рабочих дней);
- Экспресс доставка в любую точку России;
- Помощь Конструкторского Отдела и консультации квалифицированных инженеров;
- Техническая поддержка проекта, помощь в подборе аналогов, поставка прототипов;
- Поставка электронных компонентов под контролем ВП;
- Система менеджмента качества сертифицирована по Международному стандарту ISO 9001;
- При необходимости вся продукция военного и аэрокосмического назначения проходит испытания и сертификацию в лаборатории (по согласованию с заказчиком);
- Поставка специализированных компонентов военного и аэрокосмического уровня качества (Xilinx, Altera, Analog Devices, Intersil, Interpoint, Microsemi, Actel, Aeroflex, Peregrine, VPT, Syfer, Eurofarad, Texas Instruments, MS Kennedy, Miteq, Cobham, E2V, MA-COM, Hittite, Mini-Circuits, General Dynamics и др.);

Компания «Океан Электроники» является официальным дистрибьютором и эксклюзивным представителем в России одного из крупнейших производителей разъемов военного и аэрокосмического назначения «JONHON», а так же официальным дистрибьютором и эксклюзивным представителем в России производителя высокотехнологичных и надежных решений для передачи СВЧ сигналов «FORSTAR».



JONHON

«JONHON» (основан в 1970 г.)

Разъемы специального, военного и аэрокосмического назначения:

(Применяются в военной, авиационной, аэрокосмической, морской, железнодорожной, горно- и нефтедобывающей отраслях промышленности)

«FORSTAR» (основан в 1998 г.)

ВЧ соединители, коаксиальные кабели, кабельные сборки и микроволновые компоненты:

(Применяются в телекоммуникациях гражданского и специального назначения, в средствах связи, РЛС, а так же военной, авиационной и аэрокосмической отраслях промышленности).



Телефон: 8 (812) 309-75-97 (многоканальный)

Факс: 8 (812) 320-03-32

Электронная почта: ocean@oceanchips.ru

Web: <http://oceanchips.ru/>

Адрес: 198099, г. Санкт-Петербург, ул. Калинина, д. 2, корп. 4, лит. А