

FEATURES

2M x 8 MRAM Memory

- +3.3 Volt power supply
- Fast 35 ns read/write cycle
- SRAM compatible timing
- Unlimited read & write endurance
- Data always non-volatile for >20-years at temperature
- RoHS-compliant small footprint BGA and TSOP2 packages
- All products meet MSL-3 moisture sensitivity level



BENEFITS

- One memory replaces FLASH, SRAM, EEPROM and BBSRAM in systems for simpler, more efficient designs
- Improves reliability by replacing battery-backed SRAM



INTRODUCTION

The **MR4A08B** is a 16,777,216-bit magnetoresistive random access memory (MRAM) device organized as 2,097,152 words of 8 bits. The MR4A08B offers SRAM compatible 35ns read/write timing with unlimited endurance. Data is always non-volatile for greater than 20-years. Data is automatically protected on power loss by low-voltage inhibit circuitry to prevent writes with voltage out of specification. The MR4A08B is the ideal memory solution for applications that must permanently store and retrieve critical data and programs quickly.



The **MR4A08B** is available in small footprint 400-mil, 44-lead plastic small-outline TSOP type-II package or 10 mm x 10 mm, 48-pin ball grid array (BGA) package with 0.75 mm ball centers. These packages are compatible with similar low-power SRAM products and other non-volatile RAM products.

The **MR4A08B** provides highly reliable data storage over a wide range of temperatures. The product is offered with commercial (0 to +70 °C) and industrial (-40 to +85 °C) operating temperature range options.

CONTENTS

1. DEVICE PIN ASSIGNMENT.....	2
2. ELECTRICAL SPECIFICATIONS.....	4
3. TIMING SPECIFICATIONS.....	7
4. ORDERING INFORMATION.....	11
5. MECHANICAL DRAWING.....	12
6. REVISION HISTORY.....	14
How to Reach Us.....	15

1. DEVICE PIN ASSIGNMENT

Figure 1.1 Block Diagram



Table 1.1 Pin Functions

Signal Name	Function
A	Address Input
\bar{E}	Chip Enable
\bar{W}	Write Enable
\bar{G}	Output Enable
DQ	Data I/O
V_{DD}	Power Supply
V_{SS}	Ground
DC	Do Not Connect
NC	No Connection

Figure 1.2 Pin Diagrams for Available Packages (Top View)

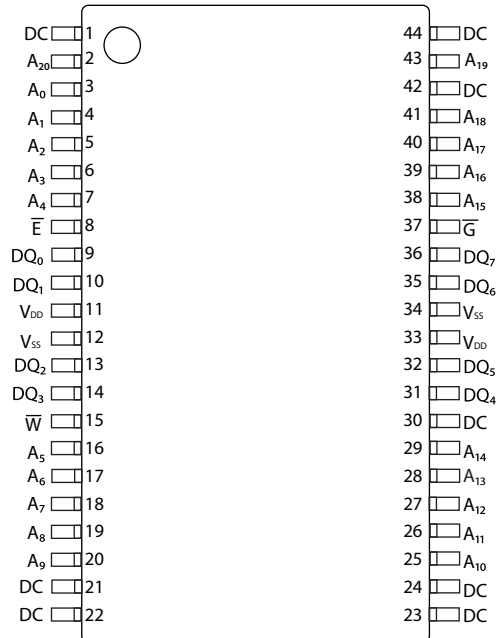

44 Pin TSOP2

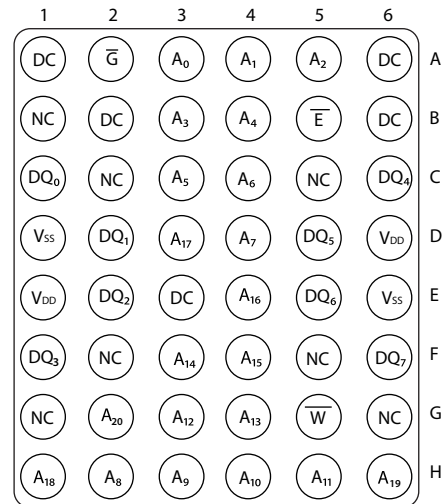

48 Pin FBGA

Table 1.2 Operating Modes

\bar{E}^1	\bar{G}^1	\bar{W}^1	Mode	V _{DD} Current	DQ[7:0] ²
H	X	X	Not selected	I _{SB1} , I _{SB2}	Hi-Z
L	H	H	Output disabled	I _{DDR}	Hi-Z
L	L	H	Byte Read	I _{DDR}	D _{Out}
L	X	L	Byte Write	I _{DDW}	D _{in}

¹ H = high, L = low, X = don't care

² Hi-Z = high impedance

2. ELECTRICAL SPECIFICATIONS

Absolute Maximum Ratings

This device contains circuitry to protect the inputs against damage caused by high static voltages or electric fields; however, it is advised that normal precautions be taken to avoid application of any voltage greater than maximum rated voltages to these high-impedance (Hi-Z) circuits.

The device also contains protection against external magnetic fields. Precautions should be taken to avoid application of any magnetic field more intense than the maximum field intensity specified in the maximum ratings.

Table 2.1 Absolute Maximum Ratings¹

Parameter	Symbol	Value	Unit
Supply voltage ²	V_{DD}	-0.5 to 4.0	V
Voltage on any pin ²	V_{IN}	-0.5 to $V_{DD} + 0.5$	V
Output current per pin	I_{OUT}	± 20	mA
Package power dissipation ³	P_D	0.600	W
Temperature under bias MR4A08B (Commercial) MR4A08BC (Industrial)	T_{BIAS}	-10 to 85 -45 to 95	°C
Storage Temperature	T_{stg}	-55 to 150	°C
Lead temperature during solder (3 minute max)	T_{Lead}	260	°C
Maximum magnetic field during write MR4A08B (All Temperatures)	H_{max_write}	8000	A/m
Maximum magnetic field during read or standby	H_{max_read}	8000	A/m

¹ Permanent device damage may occur if absolute maximum ratings are exceeded. Functional operation should be restricted to recommended operating conditions. Exposure to excessive voltages or magnetic fields could affect device reliability.

² All voltages are referenced to V_{SS} .

³ Power dissipation capability depends on package characteristics and use environment.

Table 2.2 Operating Conditions

Parameter	Symbol	Min	Typical	Max	Unit
Power supply voltage	V_{DD}	3.0 ¹	3.3	3.6	V
Write inhibit voltage	V_{WI}	2.5	2.7	3.0 ¹	V
Input high voltage	V_{IH}	2.2	-	$V_{DD} + 0.3$ ²	V
Input low voltage	V_{IL}	-0.5 ³	-	0.8	V
Temperature under bias MR4A08B (Commercial) MR4A08BC (Industrial)	T_A	0 -40		70 85	°C

1. There is a 2 ms startup time once V_{DD} exceeds $V_{DD,(\min)}$. See **Power Up and Power Down Sequencing** below.
2. $V_{IH}(\max) = V_{DD} + 0.3 V_{DC}$; $V_{IH}(\max) = V_{DD} + 2.0 V_{AC}$ (pulse width ≤ 10 ns) for $I \leq 20.0$ mA.
3. $V_{IL}(\min) = -0.5 V_{DC}$; $V_{IL}(\min) = -2.0 V_{AC}$ (pulse width ≤ 10 ns) for $I \leq 20.0$ mA.

Power Up and Power Down Sequencing

MRAM is protected from write operations whenever V_{DD} is less than V_{WI} . As soon as V_{DD} exceeds $V_{DD,(\min)}$, there is a startup time of 2 ms before read or write operations can start. This time allows memory power supplies to stabilize.

The \bar{E} and \bar{W} control signals should track V_{DD} on power up to $V_{DD} - 0.2$ V or V_{IH} (whichever is lower) and remain high for the startup time. In most systems, this means that these signals should be pulled up with a resistor so that signal remains high if the driving signal is Hi-Z during power up. Any logic that drives \bar{E} and \bar{W} should hold the signals high with a power-on reset signal for longer than the startup time.

During power loss or brownout where V_{DD} goes below V_{WI} , writes are protected and a startup time must be observed when power returns above $V_{DD,(\min)}$.

Figure 2.1 Power and Power Down Diagram



Table 2.3 DC Characteristics

Parameter	Symbol	Min	Typical	Max	Unit
Input leakage current	$I_{lkg(I)}$	-	-	± 1	μA
Output leakage current	$I_{lkg(O)}$	-	-	± 1	μA
Output low voltage ($I_{OL} = +4 \text{ mA}$) ($I_{OL} = +100 \mu\text{A}$)	V_{OL}	-	-	0.4 $V_{SS} + 0.2$	V
Output high voltage ($I_{OH} = -4 \text{ mA}$) ($I_{OH} = -100 \mu\text{A}$)	V_{OH}	2.4 $V_{DD} - 0.2$	-	-	V

Table 2.4 Power Supply Characteristics

Parameter	Symbol	Typical	Max	Unit
AC active supply current - read modes ¹ ($I_{OUT} = 0 \text{ mA}$, $V_{DD} = \text{max}$)	I_{DDR}	60	68	mA
AC active supply current - write modes ¹ ($V_{DD} = \text{max}$)	I_{DDW}	152	180	mA
AC standby current ($V_{DD} = \text{max}$, $\bar{E} = V_{IH}$) <i>no other restrictions on other inputs</i>	I_{SB1}	9	14	mA
CMOS standby current ($\bar{E} \geq V_{DD} - 0.2 \text{ V}$ and $V_{In} \leq V_{SS} + 0.2 \text{ V}$ or $\geq V_{DD} - 0.2 \text{ V}$) ($V_{DD} = \text{max}$, $f = 0 \text{ MHz}$)	I_{SB2}	5	9	mA

¹ All active current measurements are measured with one address transition per cycle and at minimum cycle time.

3. TIMING SPECIFICATIONS

Table 3.1 Capacitance¹

Parameter	Symbol	Typical	Max	Unit
Address input capacitance	C_{In}	-	6	pF
Control input capacitance	C_{In}	-	6	pF
Input/Output capacitance	$C_{I/O}$	-	8	pF

¹ $f = 1.0 \text{ MHz}$, $dV = 3.0 \text{ V}$, $T_A = 25 \text{ }^\circ\text{C}$, periodically sampled rather than 100% tested.

Table 3.2 AC Measurement Conditions

Parameter	Value	Unit
Logic input timing measurement reference level	1.5	V
Logic output timing measurement reference level	1.5	V
Logic input pulse levels	0 or 3.0	V
Input rise/fall time	2	ns
Output load for low and high impedance parameters	See Figure 3.1	
Output load for all other timing parameters	See Figure 3.2	

Figure 3.1 Output Load Test Low and High



Figure 3.2 Output Load Test All Others



Read Mode

Table 3.3 Read Cycle Timing¹

Parameter	Symbol	Min	Max	Unit
Read cycle time	t_{AVAV}	35	-	ns
Address access time	t_{AVQV}	-	35	ns
Enable access time ²	t_{ELQV}	-	35	ns
Output enable access time	t_{GLQV}	-	15	ns
Output hold from address change	t_{AXQX}	3	-	ns
Enable low to output active ³	t_{ELQX}	3	-	ns
Output enable low to output active ³	t_{GLQX}	0	-	ns
Enable high to output Hi-Z ³	t_{EHQZ}	0	15	ns
Output enable high to output Hi-Z ³	t_{GHQZ}	0	10	ns

¹ \bar{W} is high for read cycle. Power supplies must be properly grounded and decoupled, and bus contention conditions must be minimized or eliminated during read or write cycles.

² Addresses valid before or at the same time \bar{E} goes low.

³ This parameter is sampled and not 100% tested. Transition is measured ± 200 mV from the steady-state voltage.

Figure 3.3A Read Cycle 1



Note: Device is continuously selected ($\bar{E} \leq V_{IL}$, $\bar{G} \leq V_{IL}$).

Figure 3.3B Read Cycle 2



Table 3.4 Write Cycle Timing 1 (\bar{W} Controlled)¹

Parameter	Symbol	Min	Max	Unit
Write cycle time ²	t_{AVAV}	35	-	ns
Address set-up time	t_{AVWL}	0	-	ns
Address valid to end of write (\bar{G} high)	t_{AVWH}	18	-	ns
Address valid to end of write (\bar{G} low)	t_{AVWH}	20	-	ns
Write pulse width (\bar{G} high)	t_{WLWH} t_{WLEH}	15	-	ns
Write pulse width (\bar{G} low)	t_{WLWH} t_{WLEH}	15	-	ns
Data valid to end of write	t_{DVWH}	10	-	ns
Data hold time	t_{WHDX}	0	-	ns
Write low to data Hi-Z ³	t_{WLQZ}	0	12	ns
Write high to output active ³	t_{WHQX}	3	-	ns
Write recovery time	t_{WHAX}	12	-	ns

¹ All write occurs during the overlap of \bar{E} low and \bar{W} low. Power supplies must be properly grounded and decoupled and bus contention conditions must be minimized or eliminated during read and write cycles. If \bar{G} goes low at the same time or after \bar{W} goes low, the output will remain in a high impedance state. After \bar{W} , \bar{E} or \bar{UB}/\bar{LB} has been brought high, the signal must remain in steady-state high for a minimum of 2 ns. The minimum time between \bar{E} being asserted low in one cycle to \bar{E} being asserted low in a subsequent cycle is the same as the minimum cycle time allowed for the device.

² All write cycle timings are referenced from the last valid address to the first transition address.

³ This parameter is sampled and not 100% tested. Transition is measured ± 200 mV from the steady-state voltage. At any given voltage or temperature, $t_{WLQZ}(\text{max}) < t_{WHQX}(\text{min})$

Figure 3.4 Write Cycle Timing 1 (\bar{W} Controlled)

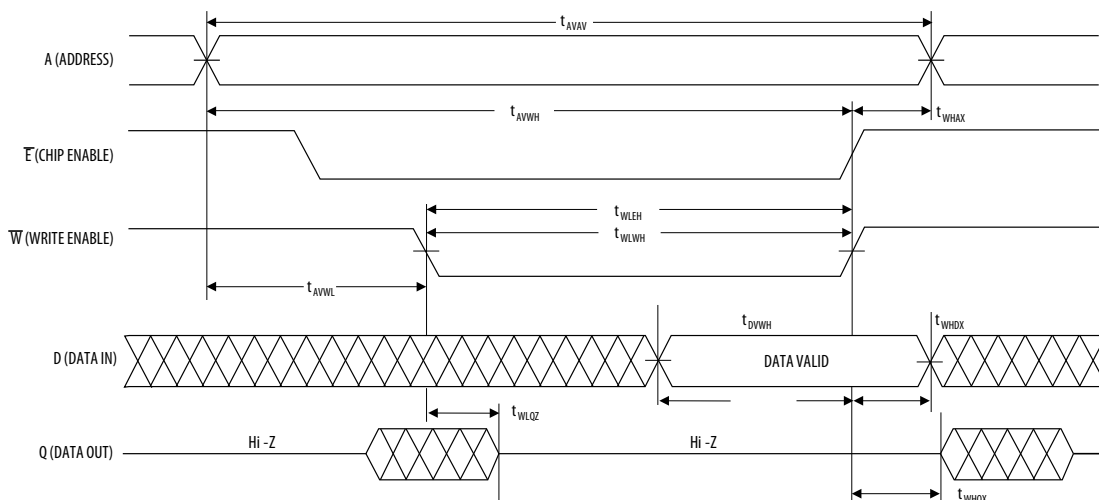

Table 3.5 Write Cycle Timing 2 (\bar{E} Controlled)¹

Parameter	Symbol	Min	Max	Unit
Write cycle time ²	t_{AVAV}	35	-	ns
Address set-up time	t_{AVEL}	0	-	ns
Address valid to end of write (\bar{G} high)	t_{AVEH}	18	-	ns
Address valid to end of write (\bar{G} low)	t_{AVEH}	20	-	ns
Enable to end of write (\bar{G} high)	t_{ELEH} t_{ELWH}	15	-	ns
Enable to end of write (\bar{G} low) ³	t_{ELEH} t_{ELWH}	15	-	ns
Data valid to end of write	t_{DVEH}	10	-	ns
Data hold time	t_{EHDX}	0	-	ns
Write recovery time	t_{EHAX}	12	-	ns

¹ All write occurs during the overlap of \bar{E} low and \bar{W} low. Power supplies must be properly grounded and decoupled and bus contention conditions must be minimized or eliminated during read and write cycles. If \bar{G} goes low at the same time or after \bar{W} goes low, the output will remain in a high impedance state. After \bar{W} , \bar{E} or \bar{UB}/\bar{LB} has been brought high, the signal must remain in steady-state high for a minimum of 2 ns. The minimum time between \bar{E} being asserted low in one cycle to \bar{E} being asserted low in a subsequent cycle is the same as the minimum cycle time allowed for the device.

² All write cycle timings are referenced from the last valid address to the first transition address.

³ If \bar{E} goes low at the same time or after \bar{W} goes low, the output will remain in a high-impedance state. If \bar{E} goes high at the same time or before \bar{W} goes high, the output will remain in a high-impedance state.

Figure 3.5 Write Cycle Timing 2 (\bar{E} Controlled)

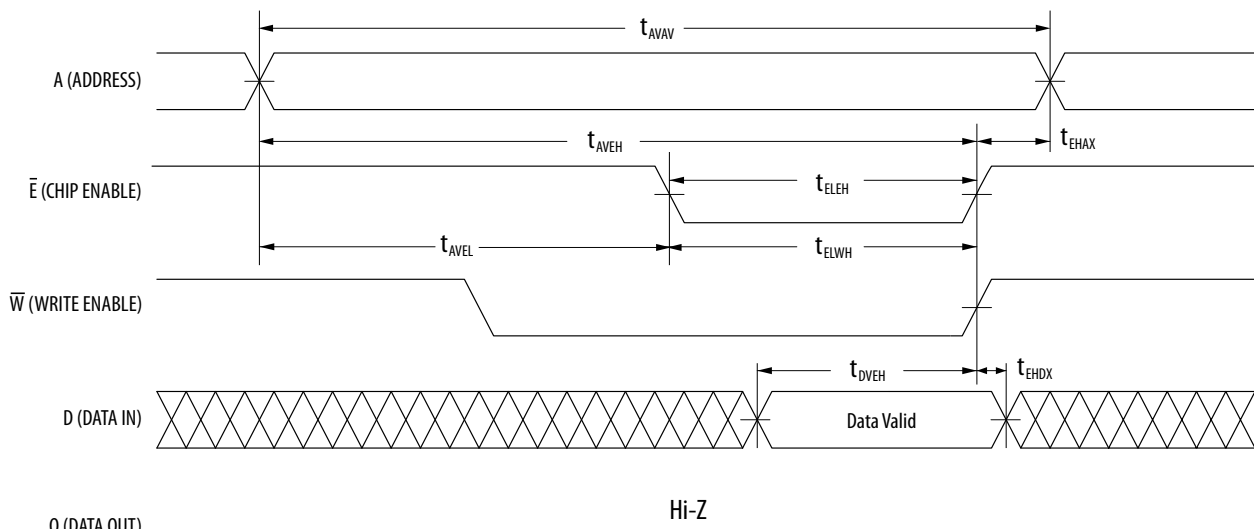

4. ORDERING INFORMATION

Figure 4.1 Part Numbering System

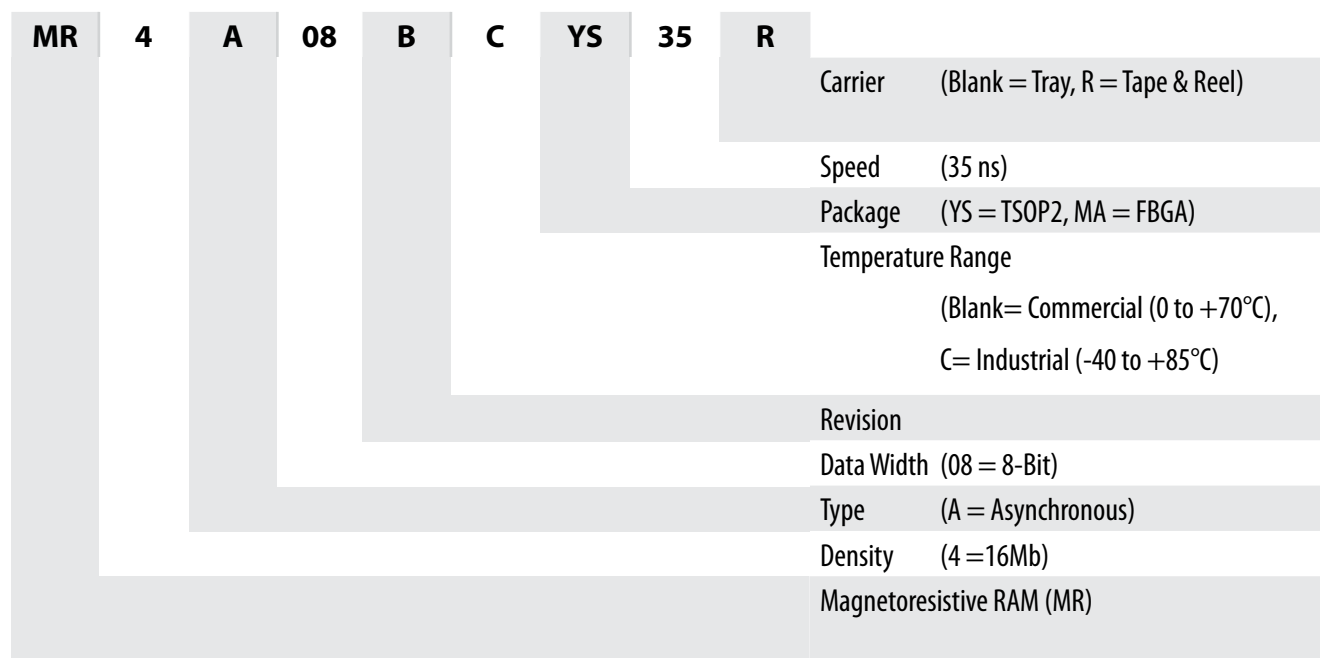

Table 4.1 Available Parts

Grade	Temp Range	Package	Shipping Container	Part Number
Commercial	0 to +70°C	44-TSOP2	Tray	MR4A08BYS35
			Tape and Reel	MR4A08BYS35R
		48-BGA	Tray	MR4A08BMA35
			Tape and Reel	MR4A08BMA35R
Industrial	-40 to +85°C	44-TSOP2	Tray	MR4A08BCYS35
			Tape and Reel	MR4A08BCYS35R
		48-BGA	Tray	MR4A08BCMA35
			Tape and Reel	MR4A08BCMA35R

Figure 5.2 FBGA



Ref	Min	Nominal	Max
A	1.19	1.27	1.35
A1	0.22	0.27	0.32
b	0.31	0.36	0.41
D	10.00 BSC		
E	10.00 BSC		
D1	5.25 BSC		
E1	3.75 BSC		
DE	0.375 BSC		
SE	0.375 BSC		
e	0.75 BSC		

Ref	Tolerance of, from and position
aaa	0.10
bbb	0.10
ddd	0.10
eee	0.15
fff	0.08

Not To Scale

1. Dimensions in Millimeters.
2. The 'e' represents the basic solder ball grid pitch.
- ③ 'b' is measurable at the maximum solder ball diameter in a plane parallel to datum C.
- ④ Dimension 'ddd' is measured parallel to primary datum C.
- ⑤ Primary datum C (seating plane) is defined by the crowns of the solder balls.
6. Package dimensions refer to JEDEC MO-205 Rev. G.

6. REVISION HISTORY

Revision	Date	Description of Change
1	May 29, 2009	Establish Speed and Power Specifications
2	July 27, 2009	Increase BGA Package to 11 mm x 11 mm
3	May 5, 2010	Changed speed marking and timing specs to 35 ns part. Changed BGA package to 10 mm x 10mm
4	Aug 10, 2011	Max. magnetic field during write ($H_{\text{max write}}$) increased to 8000 A/m.
5	March 1, 2012	Added preliminary information on AEC-Q100 Grade 1.
6	September 20, 2013	Replaced missing V_{OH} specification line in Table 2.3.
7	April 25, 2014	AEC-Q100 removed until qualified product is available.
8	September 17, 2014	48-BGA package options moisture sensitivity level upgraded to MSL-5.
8.1	May 19, 2015	Revised Everspin contact information.
8.2	June 11, 2015	Corrected Japan Sales Office telephone number.
8.3	July 29, 2015	Minor correction to the 'ddd' tolerance value for the BGA Package (Note 4.)
8.4	March 11, 2016	The BGA package moisture sensitivity level rating is changed to MSL-6 in Table 4.1.
8.5	November 22, 2016	The BGA package moisture sensitivity level rating is changed to MSL-5 in Table 4.1.
8.6	May 9, 2017	The BGA package moisture sensitivity level is upgraded to MSL-3
8.7	March 23, 2018	Updated the Contact Us table

7. HOW TO CONTACT US

How to Reach Us:

Home Page:

www.everspin.com

World Wide Information Request

WW Headquarters - Chandler, AZ

5670 W. Chandler Blvd., Suite 100

Chandler, Arizona 85226

Tel: +1-877-480-MRAM (6726)

Local Tel: +1-480-347-1111

Fax: +1-480-347-1175

support@everspin.com

orders@everspin.com

sales@everspin.com

Europe, Middle East and Africa

Everspin Europe Support

support.europe@everspin.com

Japan

Everspin Japan Support

support.japan@everspin.com

Asia Pacific

Everspin Asia Support

support.asia@everspin.com

Everspin Technologies, Inc.

Information in this document is provided solely to enable system and software implementers to use Everspin Technologies products. There are no express or implied licenses granted hereunder to design or fabricate any integrated circuit or circuits based on the information in this document. Everspin Technologies reserves the right to make changes without further notice to any products herein. Everspin makes no warranty, representation or guarantee regarding the suitability of its products for any particular purpose, nor does Everspin Technologies assume any liability arising out of the application or use of any product or circuit, and specifically disclaims any and all liability, including without limitation consequential or incidental damages. "Typical" parameters, which may be provided in Everspin Technologies data sheets and/or specifications can and do vary in different applications and actual performance may vary over time. All operating parameters including "Typicals" must be validated for each customer application by customer's technical experts. Everspin Technologies does not convey any license under its patent rights nor the rights of others. Everspin Technologies products are not designed, intended, or authorized for use as components in systems intended for surgical implant into the body, or other applications intended to support or sustain life, or for any other application in which the failure of the Everspin Technologies product could create a situation where personal injury or death may occur. Should Buyer purchase or use Everspin Technologies products for any such unintended or unauthorized application, Buyer shall indemnify and hold Everspin Technologies and its officers, employees, subsidiaries, affiliates, and distributors harmless against all claims, costs, damages, and expenses, and reasonable attorney fees arising out of, directly or indirectly, any claim of personal injury or death associated with such unintended or unauthorized use, even if such claim alleges that Everspin Technologies was negligent regarding the design or manufacture of the part. Everspin™ and the Everspin logo are trademarks of Everspin Technologies, Inc. All other product or service names are the property of their respective owners.

Copyright © 2018 Everspin Technologies, Inc.

Filename:

EST00356_MR4A08B_Datasheet_Rev8.7032318



Компания «Океан Электроники» предлагает заключение долгосрочных отношений при поставках импортных электронных компонентов на взаимовыгодных условиях!

Наши преимущества:

- Поставка оригинальных импортных электронных компонентов напрямую с производств Америки, Европы и Азии, а так же с крупнейших складов мира;
- Широкая линейка поставок активных и пассивных импортных электронных компонентов (более 30 млн. наименований);
- Поставка сложных, дефицитных, либо снятых с производства позиций;
- Оперативные сроки поставки под заказ (от 5 рабочих дней);
- Экспресс доставка в любую точку России;
- Помощь Конструкторского Отдела и консультации квалифицированных инженеров;
- Техническая поддержка проекта, помощь в подборе аналогов, поставка прототипов;
- Поставка электронных компонентов под контролем ВП;
- Система менеджмента качества сертифицирована по Международному стандарту ISO 9001;
- При необходимости вся продукция военного и аэрокосмического назначения проходит испытания и сертификацию в лаборатории (по согласованию с заказчиком);
- Поставка специализированных компонентов военного и аэрокосмического уровня качества (Xilinx, Altera, Analog Devices, Intersil, Interpoint, Microsemi, Actel, Aeroflex, Peregrine, VPT, Syfer, Eurofarad, Texas Instruments, MS Kennedy, Miteq, Cobham, E2V, MA-COM, Hittite, Mini-Circuits, General Dynamics и др.);

Компания «Океан Электроники» является официальным дистрибьютором и эксклюзивным представителем в России одного из крупнейших производителей разъемов военного и аэрокосмического назначения «JONHON», а так же официальным дистрибьютором и эксклюзивным представителем в России производителя высокотехнологичных и надежных решений для передачи СВЧ сигналов «FORSTAR».



JONHON

«JONHON» (основан в 1970 г.)

Разъемы специального, военного и аэрокосмического назначения:

(Применяются в военной, авиационной, аэрокосмической, морской, железнодорожной, горно- и нефтедобывающей отраслях промышленности)

«FORSTAR» (основан в 1998 г.)

ВЧ соединители, коаксиальные кабели, кабельные сборки и микроволновые компоненты:

(Применяются в телекоммуникациях гражданского и специального назначения, в средствах связи, РЛС, а так же военной, авиационной и аэрокосмической отраслях промышленности).



Телефон: 8 (812) 309-75-97 (многоканальный)

Факс: 8 (812) 320-03-32

Электронная почта: ocean@oceanchips.ru

Web: <http://oceanchips.ru/>

Адрес: 198099, г. Санкт-Петербург, ул. Калинина, д. 2, корп. 4, лит. А