

ADCMP551/ADCMP552/ADCMP553

FEATURES

- Single power supply
- 500 ps propagation delay input to output
- 125 ps overdrive dispersion
- Differential PECL/LVPECL compatible outputs
- Differential latch control
- Internal latch pull-up resistors
- Power supply rejection greater than 70 dB
- 700 ps minimum pulse width
- Equivalent input rise time bandwidth > 750 MHz
- Typical output rise/fall of 500 ps
- Programmable hysteresis

APPLICATIONS

- Automatic test equipment
- High speed instrumentation
- Scope and logic analyzer front ends
- Window comparators
- High speed line receivers
- Threshold detection
- Peak detection
- High speed triggers
- Patient diagnostics
- Disk drive read channel detection
- Hand-held test instruments
- Zero-crossing detectors
- Line receivers and signal restoration
- Clock drivers

FUNCTIONAL BLOCK DIAGRAM

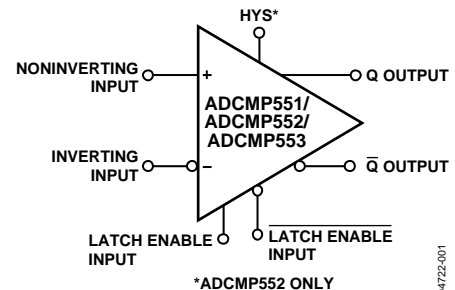

Figure 1.

GENERAL DESCRIPTION

The ADCMP551/ADCMP552/ADCMP553 are single-supply, high speed comparators fabricated on Analog Devices' proprietary XFCB process. The devices feature a 500 ps propagation delay with less than 125 ps overdrive dispersion. Overdrive dispersion, a measure of the difference in propagation delay under differing overdrive conditions, is a particularly important characteristic of high speed comparators. A separate programmable hysteresis pin is available on the ADCMP552.

A differential input stage permits consistent propagation delay with a common-mode range from -0.2 V to $V_{CCI} - 2.0\text{ V}$. Outputs are complementary digital signals and are fully compatible with PECL and 3.3V LVPECL logic families. The outputs provide sufficient drive current to directly drive transmission lines terminated in $50\ \Omega$ to $V_{CCO} - 2\text{ V}$. A latch input is included and permits tracking, track-and-hold, or sample-and-hold modes of operation. The latch input pins contain internal pull-ups that set the latch in tracking mode when left open.

The ADCMP551/ADCMP552/ADCMP553 are specified over the -40°C to $+85^{\circ}\text{C}$ industrial temperature range. The ADCMP551 is available in a 16-lead QSOP package; the ADCMP552 is available in a 20-lead QSOP package; and the ADCMP553 is available in an 8-lead MSOP package.

Rev. 0

Information furnished by Analog Devices is believed to be accurate and reliable. However, no responsibility is assumed by Analog Devices for its use, nor for any infringements of patents or other rights of third parties that may result from its use. Specifications subject to change without notice. No license is granted by implication or otherwise under any patent or patent rights of Analog Devices. Trademarks and registered trademarks are the property of their respective owners.

TABLE OF CONTENTS

| | | | |
|--|----|---|----|
| Specifications..... | 3 | Clock Timing Recovery..... | 11 |
| Absolute Maximum Ratings..... | 5 | Optimizing High Speed Performance | 11 |
| Thermal Considerations..... | 5 | Comparator Propagation Delay Dispersion | 11 |
| ESD Caution..... | 5 | Comparator Hysteresis | 12 |
| Pin Configuration and Function Descriptions..... | 6 | Minimum Input Slew Rate Requirement | 12 |
| Typical Performance Characteristics | 8 | Typical Application Circuits | 13 |
| Timing Information | 10 | Outline Dimensions | 14 |
| Application Information..... | 11 | Ordering Guide | 14 |

REVISION HISTORY

10/04—Revision 0: Initial Version

SPECIFICATIONS

$V_{CCI} = 3.3\text{ V}$, $V_{CCO} = 3.3\text{ V}$, $T_A = 25^\circ\text{C}$, unless otherwise noted.

Table 1. Electrical Characteristics

| Parameter | Symbol | Conditions | Min | Typ | Max | Unit |
|---|-------------------------|---|---------------------|-----------|---------------------|------------------------------|
| DC INPUT CHARACTERISTICS | | | | | | |
| Input Voltage Range | | | -0.2 | | $V_{CCI} - 2.0$ | V |
| Input Differential Voltage Range | | | -3 | | +3 | V |
| Input Offset Voltage | V_{OS} | $-IN = 0\text{ V}$, $+IN = 0\text{ V}$ | -10.0 | ± 2.0 | +10.0 | mV |
| Input Offset Voltage Channel Matching | | | | ± 1.0 | | mV |
| Offset Voltage Tempco | $\Delta V_{OS}/dT$ | | | 2.0 | | $\mu\text{V}/^\circ\text{C}$ |
| Input Bias Current | I_{IN} | $-IN = -0.2\text{ V}$, $+IN = +1.3\text{ V}$ | -28.0 | -6.0 | +5.0 | μA |
| Input Bias Current Tempco | | | | -5.0 | | $\text{nA}/^\circ\text{C}$ |
| Input Offset Current | | | -3.0 | ± 1.0 | +3.0 | μA |
| Input Capacitance | C_{IN} | | | 1.0 | | pF |
| Input Resistance, Differential Mode | | | | 1800 | | k Ω |
| Input Resistance, Common Mode | | | | 1000 | | k Ω |
| Active Gain | A_V | | | 60 | | dB |
| Common-Mode Rejection Ratio | CMRR | $V_{CM} = -0.2\text{ V to } +1.3\text{ V}$ | | 76 | | dB |
| Hysteresis | | $R_{HYS} = \infty$ | | ± 0.5 | | mV |
| LATCH ENABLE CHARACTERISTICS | | | | | | |
| Latch Enable Voltage Range | | | $V_{CCI} - 1.8$ | | $V_{CCI} - 0.8$ | V |
| Latch Enable Differential Voltage Range | | | 0.4 | | 1.0 | V |
| Latch Enable Input High Current | | @ $V_{CCI} - 0.8\text{ V}$ | -150 | | +150 | μA |
| Latch Enable Input Low Current | | @ $V_{CCI} - 1.8\text{ V}$ | -150 | | +150 | μA |
| LE Voltage, Open | | Latch inputs not connected | $V_{CCI} - 0.15$ | | V_{CCI} | V |
| $\overline{\text{LE}}$ Voltage, Open | | Latch inputs not connected | $V_{CCI}/2 - 0.075$ | | $V_{CCI}/2 + 0.075$ | V |
| Latch Setup Time | t_S | $V_{OD} = 250\text{ mV}$ | | 100 | | ps |
| Latch Hold Time | t_H | $V_{OD} = 250\text{ mV}$ | | 100 | | ps |
| Latch to Output Delay | t_{PLOH} , t_{PLOL} | $V_{OD} = 250\text{ mV}$ | | 450 | | ps |
| Latch Minimum Pulse Width | t_{PL} | $V_{OD} = 250\text{ mV}$ | | 700 | | ps |
| DC OUTPUT CHARACTERISTICS | | | | | | |
| Output Voltage—High Level | V_{OH} | PECL 50 Ω to $V_{DD} - 2.0\text{ V}$ | $V_{CCO} - 1.15$ | | $V_{CCO} - 0.78$ | V |
| Output Voltage—Low Level | V_{OL} | PECL 50 Ω to $V_{DD} - 2.0\text{ V}$ | $V_{CCO} - 2.00$ | | $V_{CCO} - 1.54$ | V |
| AC OUTPUT CHARACTERISTICS | | | | | | |
| Rise Time | t_R | 10% to 90% | | 510 | | ps |
| Fall Time | t_F | 10% to 90% | | 490 | | ps |
| AC OUTPUT CHARACTERISTICS (ADCMP553) | | | | | | |
| Rise Time | t_R | 10% to 90% | | 440 | | ps |
| Fall Time | t_F | 10% to 90% | | 410 | | ps |
| AC PERFORMANCE | | | | | | |
| Propagation Delay | t_{PD} | $V_{OD} = 1\text{ V}$ | | 500 | | ps |
| | | $V_{OD} = 20\text{ mV}$ | | 625 | | ps |
| Propagation Delay Tempco | $\Delta t_{PD}/dT$ | $V_{OD} = 1\text{ V}$ | | 0.25 | | $\text{ps}/^\circ\text{C}$ |
| Prop Delay Skew—Rising Transition to Falling Transition | | $V_{OD} = 1\text{ V}$ | | 35 | | ps |
| Within Device Propagation Delay Skew—Channel-to-Channel | | $V_{OD} = 1\text{ V}$ | | 35 | | ps |
| Overdrive Dispersion | | $20\text{ mV} \leq V_{OD} \leq 100\text{ mV}$ | | 75 | | ps |
| Overdrive Dispersion | | $50\text{ mV} \leq V_{OD} \leq 1.0\text{ V}$ | | 75 | | ps |
| Slew Rate Dispersion | | $0.4\text{ V/ns} \leq SR \leq 1.33\text{ V/ns}$ | | 75 | | ps |
| Pulse Width Dispersion | | $700\text{ ps} \leq PW \leq 10\text{ ns}$ | | 25 | | ps |
| Duty Cycle Dispersion | | 33 MHz, 1 V/ns, $V_{CM} = 0.5\text{ V}$ | | 10 | | ps |
| Common-Mode Voltage Dispersion | | 1 V swing, $0.3\text{ V} \leq V_{CM} \leq 0.8\text{ V}$ | | 10 | | ps |

ADCMP551/ADCMP552/ADCMP553

| Parameter | Symbol | Conditions | Min | Typ | Max | Unit |
|---|-------------------------------------|--|-------|-----|------|------|
| AC PERFORMANCE (continued) | | | | | | |
| Equivalent Input Rise Time Bandwidth ¹ | BW _{EQ} | 0 V to 1 V swing, 2 V/ns | | 750 | | MHz |
| Maximum Toggle Rate | | >50% output swing | | 800 | | MHz |
| Minimum Pulse Width | PW _{MIN} | $\Delta t_{PD} < 25$ ps | | 700 | | ps |
| RMS Random Jitter | | V _{OD} = 250 mV, 1.3 V/ns, 500 MHz, 50% duty cycle | | 1.1 | | ps |
| Unit-to-Unit Propagation Delay Skew | | | | 50 | | ps |
| POWER SUPPLY (ADCMP551/ADCMP552) | | | | | | |
| Input Supply Current | I _{VCC1} | @ 3.3 V | 8 | 12 | 17 | mA |
| Output Supply Current | I _{VCC0} | @ 3.3 V without load | 3 | 5 | 9 | mA |
| Output Supply Current | | @ 3.3 V with load | 40 | 55 | 70 | mA |
| Input Supply Voltage | V _{CC1} | Dual | 3.135 | 3.3 | 5.25 | V |
| Output Supply Voltage | V _{CC0} | Dual | 3.135 | 3.3 | 5.25 | V |
| Positive Supply Differential | V _{CC0} – V _{CC1} | | -0.2 | | +2.3 | V |
| Power Dissipation | P _D | Dual, without load | 40 | 55 | 75 | mW |
| Power Dissipation | | Dual, with load | 90 | 110 | 130 | mW |
| DC Power Supply Rejection Ratio—V _{CC1} | PSRR _{VCC1} | | | 75 | | dB |
| DC Power Supply Rejection Ratio—V _{CC0} | PSRR _{VCC0} | | | 85 | | dB |
| POWER SUPPLY (ADCMP553) | | | | | | |
| Positive Supply Current | I _{VCC} | @ 3.3 V without load | | 9 | 13 | mA |
| Positive Supply Current | | @ 3.3 V with load | | 35 | 42 | mA |
| Positive Supply Voltage | V _{CC} | Dual | 3.135 | 3.3 | 5.25 | V |
| Power Dissipation | P _D | Dual, without load | | 30 | 42 | mW |
| Power Dissipation | | Dual, with load | | 60 | 75 | mW |
| DC Power Supply Rejection Ratio—V _{CC} | PSRR _{VCC} | | | 70 | | dB |
| HYSTERESIS (ADCMP552 Only) | | | | | | |
| Programmable Hysteresis | | | 0 | | 40 | mV |

¹ Equivalent input rise time bandwidth assumes a first order input response and is calculated by the following formula: $BW_{EQ} = .22/\sqrt{(t_{r_{COMP}}^2 - t_{r_{IN}}^2)}$, where $t_{r_{IN}}$ is the 20/80 input transition time applied to the comparator and $t_{r_{COMP}}$ is the effective transition time as digitized by the comparator input.

ABSOLUTE MAXIMUM RATINGS

Table 2.

| Parameter | Rating |
|---|------------------|
| Supply Voltages | |
| Input Supply Voltage (V_{CC1} to GND) | -0.5 V to +6.0 V |
| Output Supply Voltage (V_{CC0} to GND) | -0.5 V to +6.0 V |
| Ground Voltage Differential | -0.5 V to +0.5 V |
| Input Voltages | |
| Input Common-Mode Voltage | -0.5 V to +3.5 V |
| Differential Input Voltage | -4.0 V to +4.0 V |
| Input Voltage, Latch Controls | -0.5 V to +5.5 V |
| Output | |
| Output Current | 30 mA |
| Temperature | |
| Operating Temperature, Ambient | -40°C to +85°C |
| Operating Temperature, Junction | 125°C |
| Storage Temperature Range | -65°C to +150°C |

Stresses above those listed under Absolute Maximum Ratings may cause permanent damage to the device. This is a stress rating only; functional operation of the device at these or any other conditions above those indicated in the operational sections of this specification is not implied. Exposure to absolute maximum rating conditions for extended periods may affect device reliability.

THERMAL CONSIDERATIONS

The ADCMP551 16-lead QSOP package has a θ_{JA} (junction-to-ambient thermal resistance) of 104°C/W in still air.

The ADCMP552 20-lead QSOP package has a θ_{JA} (junction-to-ambient thermal resistance) of 80°C/W in still air.

The ADCMP553 8-lead MSOP package has a θ_{JA} (junction-to-ambient thermal resistance) of 130°C/W in still air.

ESD CAUTION

ESD (electrostatic discharge) sensitive device. Electrostatic charges as high as 4000 V readily accumulate on the human body and test equipment and can discharge without detection. Although this product features proprietary ESD protection circuitry, permanent damage may occur on devices subjected to high energy electrostatic discharges. Therefore, proper ESD precautions are recommended to avoid performance degradation or loss of functionality.



ADCMP551/ADCMP552/ADCMP553

PIN CONFIGURATION AND FUNCTION DESCRIPTIONS



Figure 2. ADCMP551 16-Lead QSOP Pin Configuration

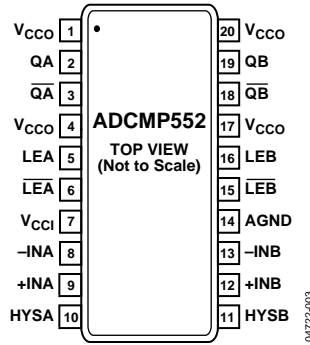

Figure 3. ADCMP552 20-Lead QSOP Pin Configuration

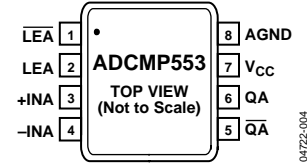

Figure 4. ADCMP553 8-Lead MSOP Pin Configuration

Table 3. Pin Function Descriptions

| Pin No. | | | Mnemonic | Function |
|----------|--------------|----------|------------------|--|
| ADCMP551 | ADCMP552 | ADCMP553 | | |
| 3, 14 | 1, 4, 17, 20 | | V _{CCO} | Logic Supply Terminal. |
| 1 | 2 | 6 | QA | One of Two Complementary Outputs for Channel A. QA is logic high if the analog voltage at the noninverting input is greater than the analog voltage at the inverting input (provided the comparator is in the compare mode). See the description of Pin LEA for more information. |
| 2 | 3 | 5 | \overline{QA} | One of Two Complementary Outputs for Channel A. \overline{QA} is logic low if the analog voltage at the noninverting input is greater than the analog voltage at the inverting input (provided the comparator is in the compare mode). See the description of Pin LEA for more information. |
| 4 | 5 | 2 | LEA | One of Two Complementary Outputs for Channel A Latch Enable. In the compare mode (logic high), the output tracks changes at the input of the comparator. In the latch mode (logic low), the output reflects the input state just prior to the comparator's being placed in the latch mode. \overline{LEA} must be driven in conjunction with LEA. |
| 5 | 6 | 1 | \overline{LEA} | One of Two Complementary Outputs for Channel A Latch Enable. In the compare mode (logic high), the output tracks changes at the input of the comparator. In the latch mode (logic low), the output reflects the input state just prior to the comparator's being placed in the latch mode. LEA must be driven in conjunction with \overline{LEA} . |
| 6 | 7 | | V _{CCI} | Input Supply Terminal. |
| 7 | 8 | 4 | -INA | Inverting Analog Input of the Differential Input Stage for Channel A. The inverting A input must be driven in conjunction with the noninverting A input. |
| 8 | 9 | 3 | +INA | Noninverting Analog Input of the Differential Input Stage for Channel A. The noninverting A input must be driven in conjunction with the inverting A input. |
| | 10 | | HYSA | Programmable Hysteresis. |
| | 11 | | HYSB | Programmable Hysteresis. |
| 9 | 12 | | +INB | Noninverting Analog Input of the Differential Input Stage for Channel B. The noninverting B input must be driven in conjunction with the inverting B input. |
| 10 | 13 | | -INB | Inverting Analog Input of the Differential Input Stage for Channel B. The inverting B input must be driven in conjunction with the noninverting B input. |
| 11 | 14 | 8 | AGND | Analog Ground. |

ADCMP551/ADCMP552/ADCMP553

| Pin No. | | | Mnemonic | Function |
|----------|----------|----------|------------------|---|
| ADCMP551 | ADCMP552 | ADCMP553 | | |
| 12 | 15 | | \overline{LEB} | One of Two Complementary Inputs for Channel B Latch Enable. In the compare mode (logic low), the output tracks changes at the input of the comparator. In the latch mode (logic high), the output reflects the input state just prior to the comparator's being placed in the latch mode. LEB must be driven in conjunction with \overline{LEB} . |
| 13 | 16 | | LEB | One of Two Complementary Inputs for Channel B Latch Enable. In the compare mode (logic low), the output tracks changes at the input of the comparator. In the latch mode (logic high), the output reflects the input state just prior to the comparator's being placed in the latch mode. LEB must be driven in conjunction with \overline{LEB} . |
| 15 | 18 | | \overline{QB} | One of Two Complementary Outputs for Channel B. \overline{QB} is logic low if the analog voltage at the noninverting input is greater than the analog voltage at the inverting input (provided the comparator is in the compare mode). See the description of Pin LEB for more information. |
| 16 | 19 | | QB | One of Two Complementary Outputs for Channel B. QB is logic high if the analog voltage at the noninverting input is greater than the analog voltage at the inverting input (provided the comparator is in the compare mode). See the description of Pin LEB for more information. |
| | | 7 | V _{CC} | Positive Supply Terminal. |

ADCMP551/ADCMP552/ADCMP553

TYPICAL PERFORMANCE CHARACTERISTICS

$V_{CC1} = 3.3\text{ V}$, $V_{CC0} = 3.3\text{ V}$, $T_A = 25^\circ\text{C}$, unless otherwise noted.



Figure 5. Input Bias Current vs. Input Voltage



Figure 8. Input Bias Current vs. Temperature



Figure 6. Input Offset Voltage vs. Temperature



Figure 9. Rise and Fall of Outputs vs. Time



Figure 7. ADCMP551/2 Rise/Fall Time vs. Temperature



Figure 10. ADCMP553 Rise/Fall Time vs. Temperature



Figure 11. Propagation Delay vs. Temperature

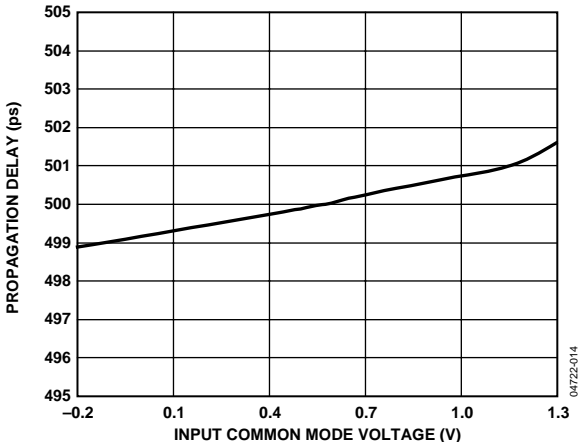

Figure 14. Propagation Delay vs. Common-Mode Voltage

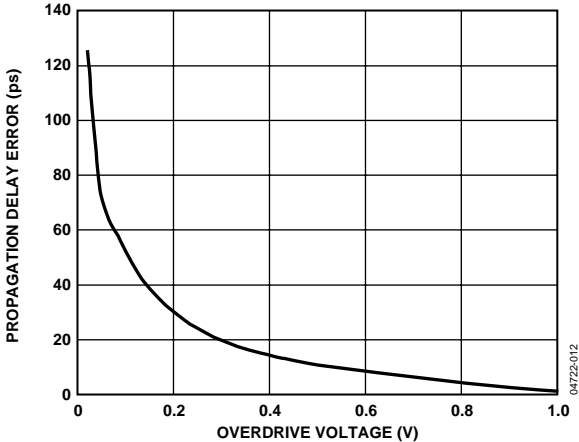

Figure 12. Propagation Delay vs. Overdrive Voltage

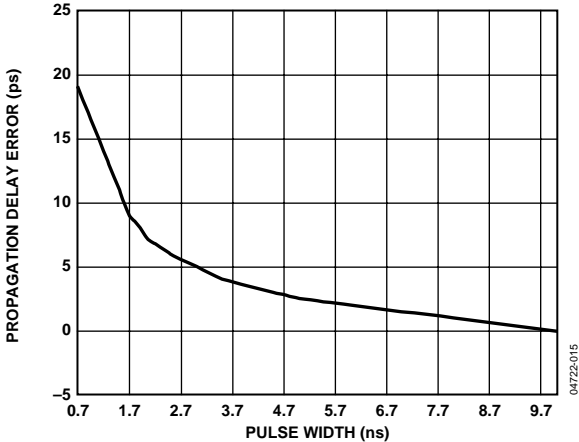

Figure 15. Propagation Delay Error vs. Pulse Width

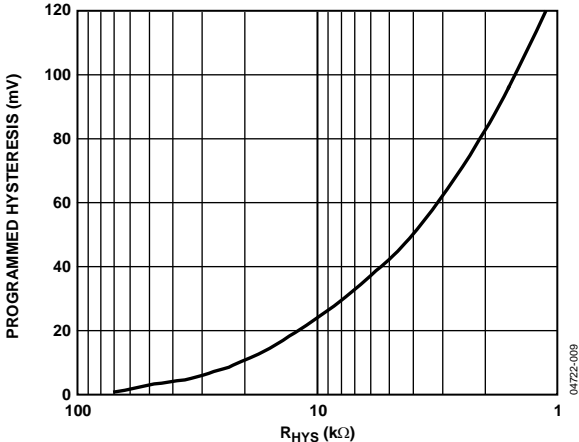

Figure 13. Comparator Hysteresis vs. R_{HYS}

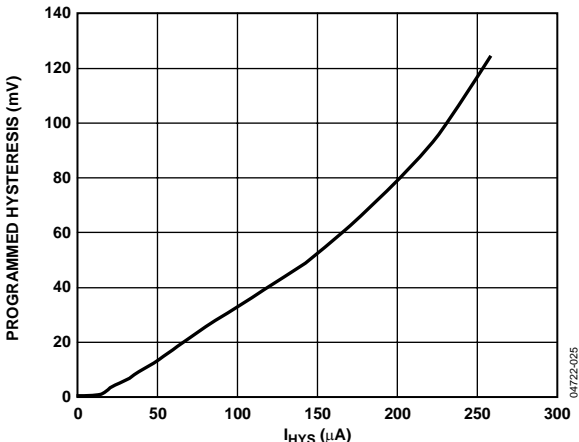

Figure 16. Comparator Hysteresis vs. I_{HYS}

TIMING INFORMATION



Figure 17. System Timing Diagram

Figure 17 shows the compare and latch features of the ADCMP55x family. Table 4 describes the terms in the diagram.

Table 4. Timing Descriptions

| Symbol | Timing | Description |
|------------|-----------------------------------|--|
| t_{PDH} | Input to Output High Delay | Propagation delay measured from the time the input signal crosses the reference (\pm the input offset voltage) to the 50% point of an output low-to-high transition |
| t_{PDL} | Input to Output Low Delay | Propagation delay measured from the time the input signal crosses the reference (\pm the input offset voltage) to the 50% point of an output high-to-low transition |
| t_{PLOH} | Latch Enable to Output High Delay | Propagation delay measured from the 50% point of the latch enable signal low-to-high transition to the 50% point of an output low-to-high transition |
| t_{PLOL} | Latch Enable to Output Low Delay | Propagation delay measured from the 50% point of the latch enable signal low-to-high transition to the 50% point of an output high-to-low transition |
| t_H | Minimum Hold Time | Minimum time after the negative transition of the latch enable signal that the input signal must remain unchanged to be acquired and held at the outputs |
| t_{PL} | Minimum Latch Enable Pulse Width | Minimum time the latch enable signal must be high to acquire an input signal change |
| t_S | Minimum Setup Time | Minimum time before the negative transition of the latch enable signal that an input signal change must be present to be acquired and held at the outputs |
| t_R | Output Rise Time | Amount of time required to transition from a low to a high output as measured at the 20% and 80% points |
| t_F | Output Fall Time | Amount of time required to transition from a high to a low output as measured at the 20% and 80% points |
| V_{OD} | Voltage Overdrive | Difference between the differential input and reference input voltages |

APPLICATION INFORMATION

The comparators in the ADCMP55x series are very high speed devices. Consequently, high speed design techniques must be employed to achieve the best performance. The most critical aspect of any ADCMP55x design is the use of a low impedance ground plane. A ground plane, as part of a multilayer board, is recommended for proper high speed performance. Using a continuous conductive plane over the surface of the circuit board can create this, allowing breaks in the plane only for necessary signal paths. The ground plane provides a low inductance ground, eliminating any potential differences at different ground points throughout the circuit board caused by ground bounce. A proper ground plane also minimizes the effects of stray capacitance on the circuit board.

It is also important to provide bypass capacitors for the power supply in a high speed application. A 1 μ F electrolytic bypass capacitor should be placed within 0.5 inches of each power supply pin to ground. These capacitors reduce any potential voltage ripples from the power supply. In addition, a 10 nF ceramic capacitor should be placed as close to the power supply pins as possible on the ADCMP55x to ground. These capacitors act as a charge reservoir for the device during high frequency switching.

The LATCH ENABLE input is active low (latched). If the latching function is not used, the LATCH ENABLE input pins may be left open. The internal pull-ups on the latch pins set the latch to transparent mode. If the latch is to be used, valid PECL voltages are required on the inputs for proper operation. The PECL voltages should be referenced to V_{CCI} .

Occasionally, one of the two comparator stages within the ADCMP551/ADCMP552 is not used. The inputs of the unused comparator should not be allowed to float. The high internal gain may cause the output to oscillate (possibly affecting the comparator that is being used) unless the output is forced into a fixed state. This is easily accomplished by ensuring that the two inputs are at least one diode drop apart, while also appropriately connecting the LATCH ENABLE and $\overline{\text{LATCH ENABLE}}$ inputs as described previously.

The best performance is achieved with the use of proper PECL terminations. The open-emitter outputs of the ADCMP55x are designed to be terminated through 50 Ω resistors to $V_{CCO} - 2.0$ V or any other equivalent PECL termination. If high speed PECL signals must be routed more than a centimeter, microstrip or stripline techniques may be required to ensure proper transition times and prevent output ringing.

CLOCK TIMING RECOVERY

Comparators are often used in digital systems to recover clock timing signals. High speed square waves transmitted over a distance, even tens of centimeters, can become distorted due to stray capacitance and inductance. Poor layout or improper termination can also cause reflections on the transmission line, further distorting the signal waveform. A high speed comparator can be used to recover the distorted waveform while maintaining a minimum of delay.

OPTIMIZING HIGH SPEED PERFORMANCE

As with any high speed comparator amplifier, proper design and layout techniques should be used to ensure optimal performance from the ADCMP55x. The performance limits of high speed circuitry can easily be a result of stray capacitance, improper ground impedance, or other layout issues.

Minimizing resistance from source to the input is an important consideration in maximizing the high speed operation of the ADCMP55x. Source resistance in combination with equivalent input capacitance can cause a lagged response at the input, thus delaying the output. The input capacitance of the ADCMP55x, in combination with stray capacitance from an input pin to ground, could result in several picofarads of equivalent capacitance. A combination of 3 k Ω source resistance and 5 pF input capacitance yields a time constant of 15 ns, which is significantly slower than the 500 ps capability of the ADCMP55x. Source impedances should be significantly less than 100 Ω for best performance.

Sockets should be avoided due to stray capacitance and inductance. If proper high speed techniques are used, the ADCMP55x should be free from oscillation when the comparator input signal passes through the switching threshold.

COMPARATOR PROPAGATION DELAY DISPERSION

The ADCMP55x has been specifically designed to reduce propagation delay dispersion over an input overdrive range of 20 mV to 1 V. Propagation delay overdrive dispersion is the change in propagation delay that results from a change in the degree of overdrive (how far the switching point is exceeded by the input). The overall result is a higher degree of timing accuracy since the ADCMP55x is far less sensitive to input variations than most comparator designs.

ADCMP551/ADCMP552/ADCMP553

Propagation delay dispersion is an important specification in critical timing applications such as ATE, bench instruments, and nuclear instrumentation. Overdrive dispersion is defined as the variation in propagation delay as the input overdrive conditions are changed (Figure 18). For the ADCMP55x, overdrive dispersion is typically 125 ps as the overdrive is changed from 20 mV to 1 V. This specification applies for both positive and negative overdrive since the ADCMP55x has equal delays for positive- and negative-going inputs.

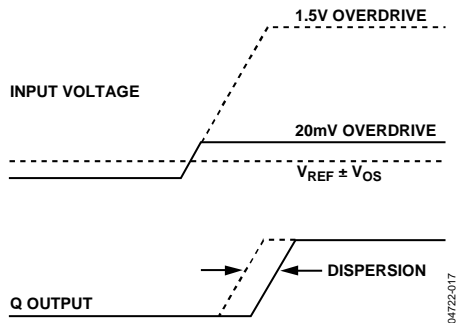

Figure 18. Propagation Delay Dispersion

COMPARATOR HYSTERESIS

The addition of hysteresis to a comparator is often useful in a noisy environment or where it is not desirable for the comparator to toggle between states when the input signal is at the switching threshold. The transfer function for a comparator with hysteresis is shown in Figure 19. If the input voltage approaches the threshold from the negative direction, the comparator switches from a 0 to a 1 when the input crosses $+V_H/2$. The new switching threshold becomes $-V_H/2$. The comparator remains in a 1 state until the $-V_H/2$ threshold is crossed coming from the positive direction. In this manner, noise centered on 0 V input does not cause the comparator to switch states unless it exceeds the region bounded by $\pm V_H/2$.

Positive feedback from the output to the input is often used to produce hysteresis in a comparator (Figure 23). The major problem with this approach is that the amount of hysteresis varies with the output logic levels, resulting in a hysteresis that is not symmetrical around zero.

In the ADCMP552, hysteresis is generated through the programmable hysteresis pin. A resistor from the HYS pin to V_{CCI} creates a current into the part that is used to generate hysteresis. Hysteresis generated in this manner is independent of output swing and is symmetrical around the trip point. The hysteresis versus resistance curve is shown in Figure 20.

A current source can also be used with the HYS pin. The relationship between the current applied to the HYS pin and the resulting hysteresis is shown in Figure 16.

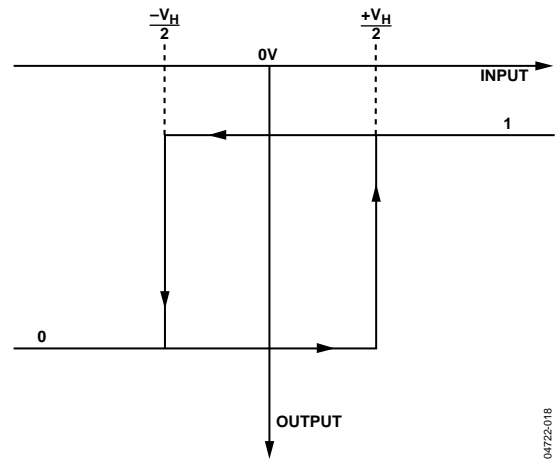

Figure 19. Comparator Hysteresis Transfer Function

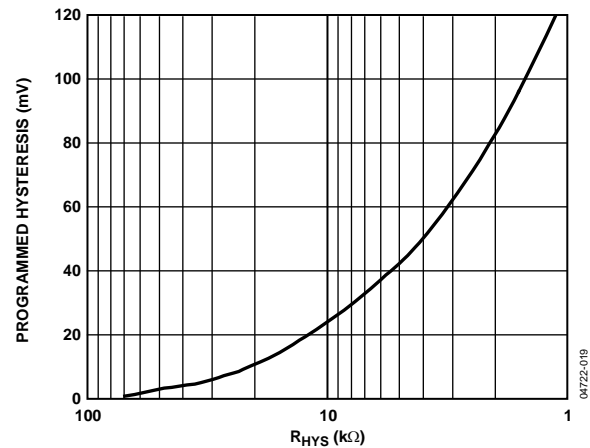

Figure 20. Comparator Hysteresis Transfer Function

MINIMUM INPUT SLEW RATE REQUIREMENT

As for all high speed comparators, a minimum slew rate must be met to ensure that the device does not oscillate when the input crosses the threshold. This oscillation is due in part to the high input bandwidth of the comparator and the parasitics of the package. Analog Devices recommends a slew rate of $1 \text{ V}/\mu\text{s}$ or faster to ensure a clean output transition. If slew rates less than $1 \text{ V}/\mu\text{s}$ are used, hysteresis should be added to reduce the oscillation.

TYPICAL APPLICATION CIRCUITS

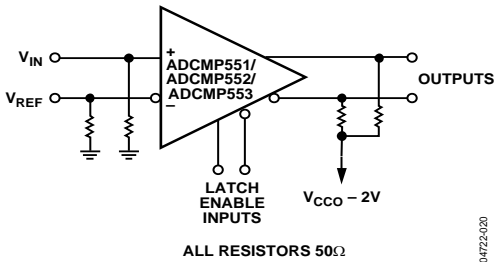

Figure 21. High Speed Sampling Circuits

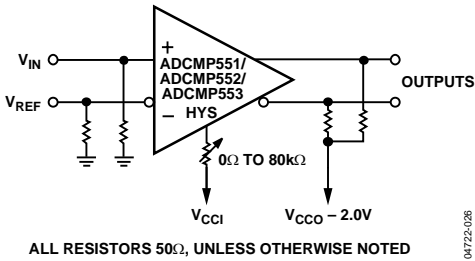

Figure 23. Adding Hysteresis Using the HYS Control Pin

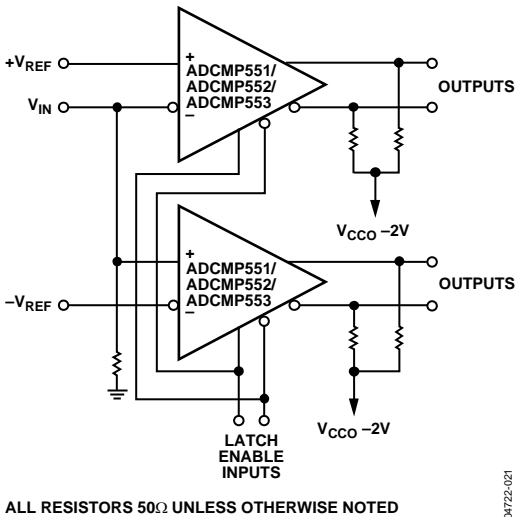

Figure 22. High Speed Window Comparator

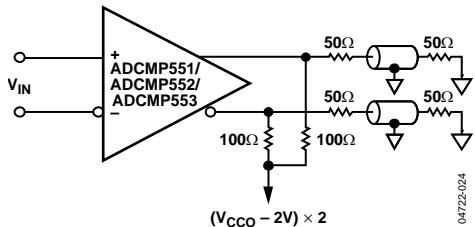

Figure 24. How to Interface a PECL Output to an Instrument with a 50Ω to Ground Input

ADCMP551/ADCMP552/ADCMP553

OUTLINE DIMENSIONS

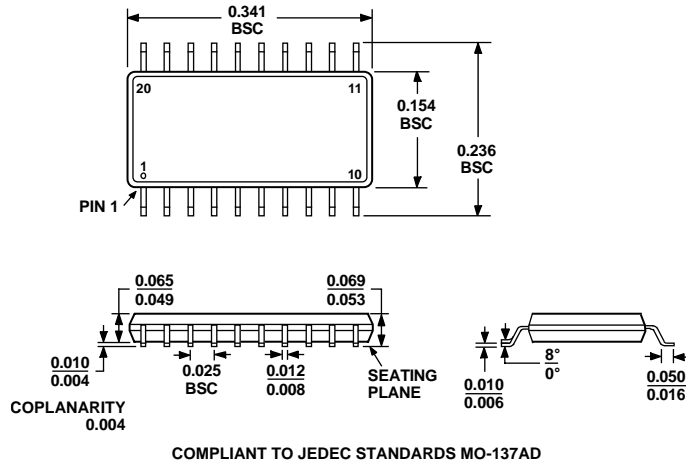

Figure 25. 20-Lead Shrink Small Outline Package [QSOP] (RQ-20)
Dimensions shown in inches

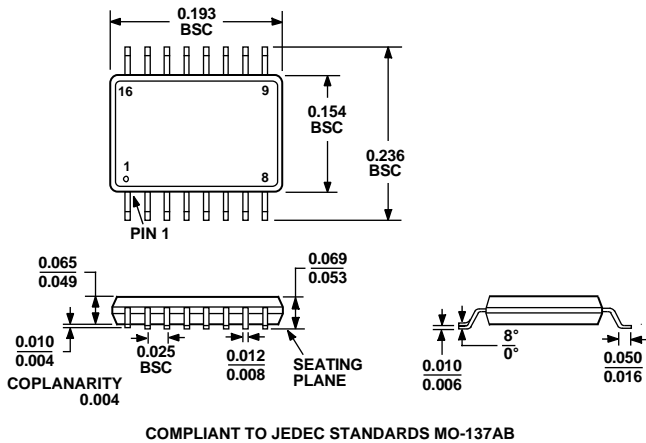

Figure 26. 16-Lead Shrink Small Outline Package [QSOP] (RQ-16)
Dimensions shown in inches

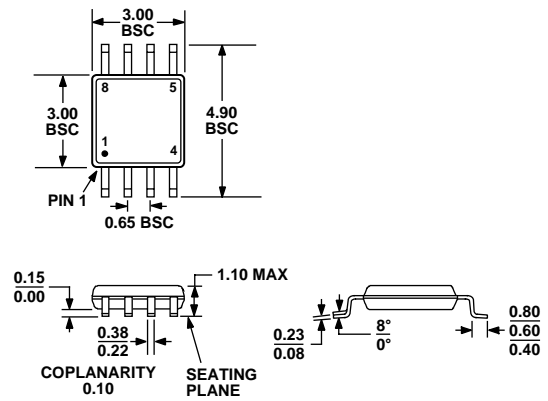

Figure 27. 8-Lead Mini Small Outline Package [MSOP] (RM-8)
Dimensions shown in millimeters

ORDERING GUIDE

| Model | Temperature Range | Package Description | Package Option | Branding |
|------------------|-------------------|---------------------|----------------|----------|
| ADCMP551BRQ | -40°C to +85°C | 16-Lead QSOP | RQ-16 | B53 |
| ADCMP552BRQ | -40°C to +85°C | 20-Lead QSOP | RQ-20 | |
| ADCMP553BRM | -40°C to +85°C | 8-Lead MSOP | RM-8 | |
| EVAL-ADCMP551BRQ | | EVALUATION BOARD | | |
| EVAL-ADCMP552BRQ | | EVALUATION BOARD | | |

NOTES

NOTES

Компания «Океан Электроники» предлагает заключение долгосрочных отношений при поставках импортных электронных компонентов на взаимовыгодных условиях!

Наши преимущества:

- Поставка оригинальных импортных электронных компонентов напрямую с производств Америки, Европы и Азии, а так же с крупнейших складов мира;
- Широкая линейка поставок активных и пассивных импортных электронных компонентов (более 30 млн. наименований);
- Поставка сложных, дефицитных, либо снятых с производства позиций;
- Оперативные сроки поставки под заказ (от 5 рабочих дней);
- Экспресс доставка в любую точку России;
- Помощь Конструкторского Отдела и консультации квалифицированных инженеров;
- Техническая поддержка проекта, помощь в подборе аналогов, поставка прототипов;
- Поставка электронных компонентов под контролем ВП;
- Система менеджмента качества сертифицирована по Международному стандарту ISO 9001;
- При необходимости вся продукция военного и аэрокосмического назначения проходит испытания и сертификацию в лаборатории (по согласованию с заказчиком);
- Поставка специализированных компонентов военного и аэрокосмического уровня качества (Xilinx, Altera, Analog Devices, Intersil, Interpoint, Microsemi, Actel, Aeroflex, Peregrine, VPT, Syfer, Eurofarad, Texas Instruments, MS Kennedy, Miteq, Cobham, E2V, MA-COM, Hittite, Mini-Circuits, General Dynamics и др.);

Компания «Океан Электроники» является официальным дистрибьютором и эксклюзивным представителем в России одного из крупнейших производителей разъемов военного и аэрокосмического назначения «JONHON», а так же официальным дистрибьютором и эксклюзивным представителем в России производителя высокотехнологичных и надежных решений для передачи СВЧ сигналов «FORSTAR».



JONHON

«JONHON» (основан в 1970 г.)

Разъемы специального, военного и аэрокосмического назначения:

(Применяются в военной, авиационной, аэрокосмической, морской, железнодорожной, горно- и нефтедобывающей отраслях промышленности)

«FORSTAR» (основан в 1998 г.)

ВЧ соединители, коаксиальные кабели,
кабельные сборки и микроволновые компоненты:

(Применяются в телекоммуникациях гражданского и специального назначения, в средствах связи, РЛС, а так же военной, авиационной и аэрокосмической отраслях промышленности).



Телефон: 8 (812) 309-75-97 (многоканальный)

Факс: 8 (812) 320-03-32

Электронная почта: ocean@oceanchips.ru

Web: <http://oceanchips.ru/>

Адрес: 198099, г. Санкт-Петербург, ул. Калинина, д. 2, корп. 4, лит. А