

# LPI series

## Tactile pushbutton switches with large actuator

*Distinctive features and applications*



### ❑ Common features

- Large ergonomic actuator (Ø 35 mm)
- Tactile feedback
- Low behind-panel depth (21 mm max.)
- Stylish design
- Long life

This series has been developed on a modular base in order to fit the exact needs of technicians and end-users.



### ❑ Installation options

The LPI series has a number of features to ensure easy installation:

- **Front or rear mounting**
- With or without sealing
- 2 separate circuits for NO/NC 5A version
- Terminal block connector for 0,1A NO version
- 3 different LED voltages: 6V, 12V, 24V
- Integrated LED resistor



### ❑ Aesthetic options

- **Ring or dot illumination**
- Wide range of LED colours
- Wide range of bezel colours
- Many different actuator types and colours

### ❑ Designed to meet the requirements of EN81-70

This product meets the requirements of EN81-70 and is ideal for use in all types of indoor lifts.



### ❑ Flexibility of marking





# LPI series

## Tactile pushbutton switches with large actuator

Overview

### SWITCH BLOCK

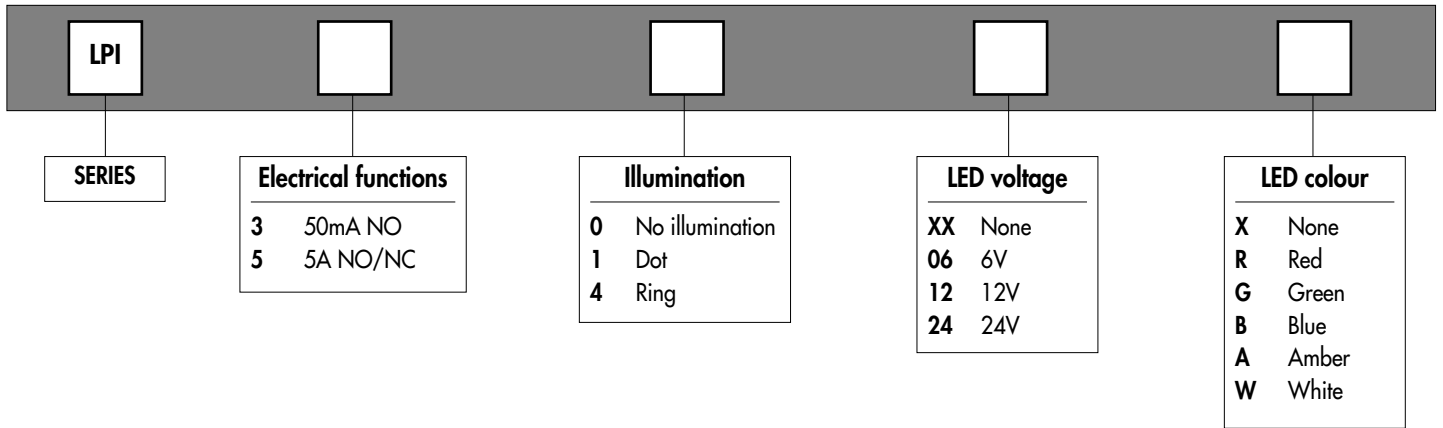

### OPERATOR

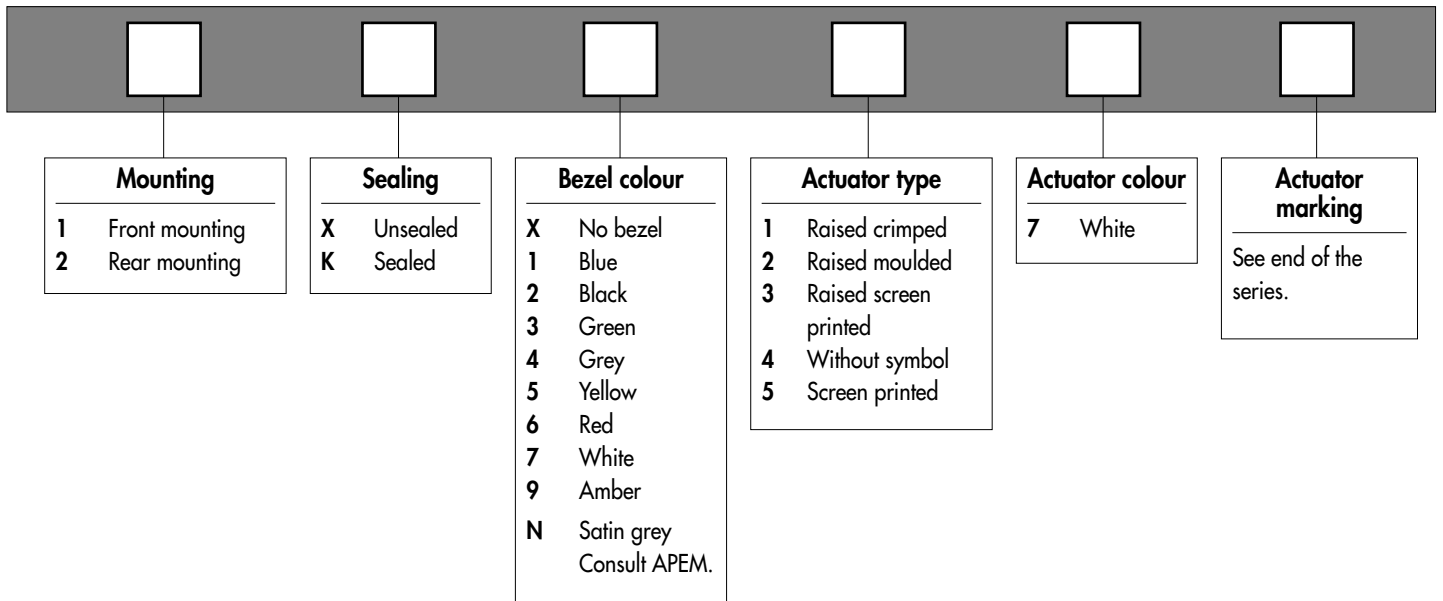

#### ABOUT THIS SERIES

On the following pages, you will find successively switch block order numbers and operator order numbers.

**Dimensions** : first dimensions are in m while inches are shown as bracketed numbers.



**NOTICE** : please note that not all combinations of above numbers are available. Refer to the following pages for further information.



**Packaging unit** : 15 pieces for front mounting versions - 20 pieces for rear mounting versions.



**Sealing boot** available to increase the sealing of LPI switches. See section H.

# LPI series

Tactile pushbutton switches with large actuator

Switch block

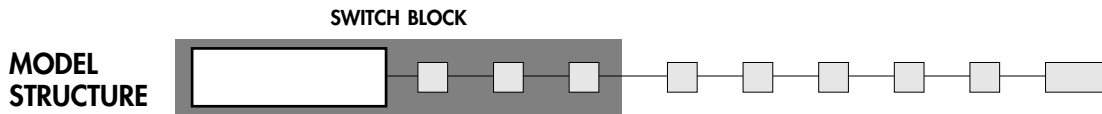

## 5A momentary NC/NO combined



LPI5

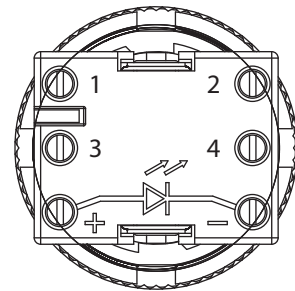
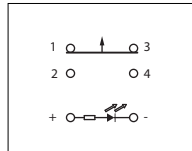

### Terminal block

Wire size : AWG20-15 - 0,5 to 1,5 mm<sup>2</sup>  
Rated torque : 0,5 Nm  
Screw size : M3

## 50mA momentary NO



LPI3

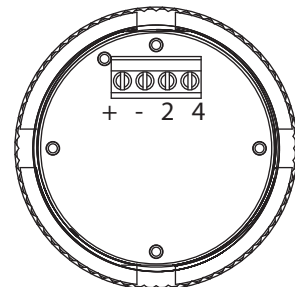
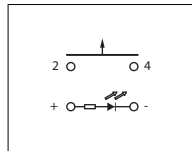

### Terminal block

Wire size : AWG28-16 - 0,5 to 1 mm<sup>2</sup>  
Rated torque : 0,4 Nm  
Screw size : M2

B2

# LPI series

## Tactile pushbutton switches with large actuator

### Switch block

#### ILLUMINATION

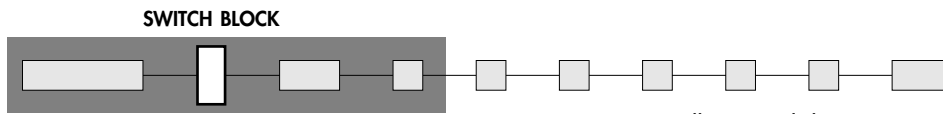

- 0 Non-illuminated
- 1 Illuminated dot (1 LED)
- 4 Illuminated ring (4 LEDs)

Option 4 available only in the case of screen-printed symbol

Illuminated dot



Option 1

Illuminated ring



Option 4

#### LED VOLTAGE

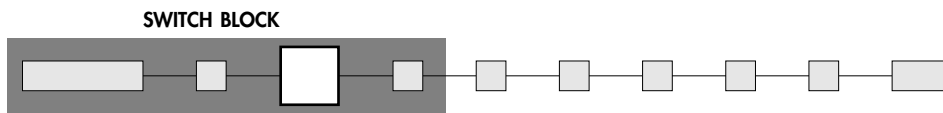

- XX Non-illuminated
- 06 6V
- 12 12V
- 24 24V



Combination with other options : see table below.

- Integrated resistors
- LED current : 20mA typical for dot or ring (30mA max.)
- LEDs protected from reverse polarity
- Stand-by consumption for illuminated product : 0,5VA max.

#### LED COLOUR

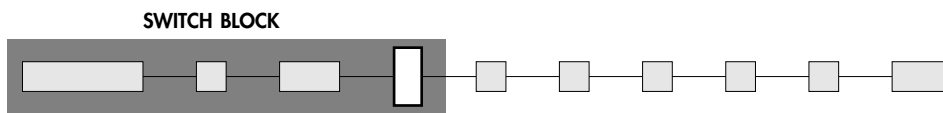

- X Non-illuminated
- R Red
- G Green
- A Amber
- B Blue
- W White

For illuminated ring, see table opposite.

#### Colours available with illuminated ring (option 4)

	Red	Green	Amber	Blue	White
LED voltage	<b>Version 5A</b>				
6V	No	No	No	No	No
12V	Yes	Yes	No	No	No
24V	Yes	Yes	Yes	Yes	Yes
LED voltage	<b>Version 50mA</b>				
6V	No	No	No	No	No
12V	Yes	No	Yes	No	No
24V	Yes	Yes	Yes	Yes	Yes@

# LPI series

Tactile pushbutton switches with large actuator

Operator

## MOUNTING

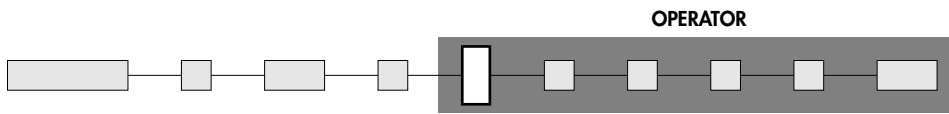

- 1 Front mounting
- 2 Rear mounting

### FRONT MOUNTING - 50mA version

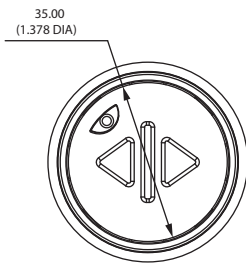
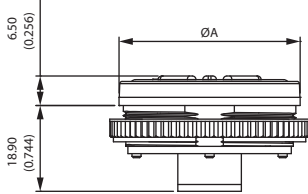

### FRONT MOUNTING - 5A version

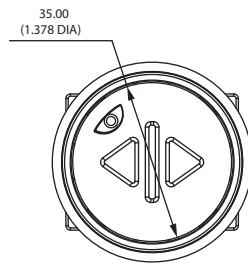
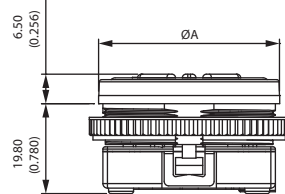

### REAR MOUNTING - all versions

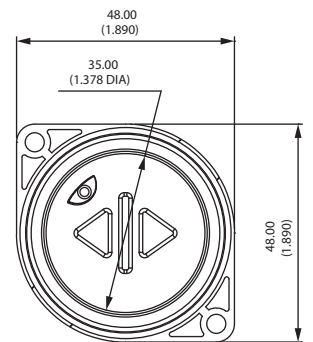
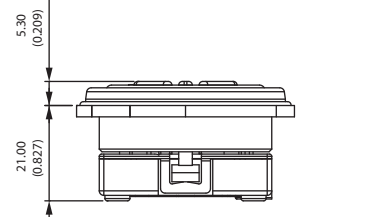

### MATRIX MOUNTING

All versions

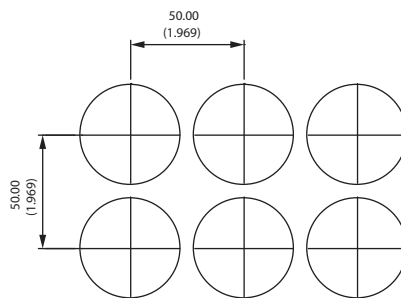

### Dimension A

Sealed models : 44 mm (1.732)

Unsealed models : 39,9 mm (1.570)

## SEALING

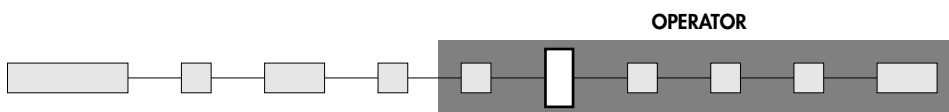

- X Unsealed
- K Sealed

Note : bezel compulsory on sealed versions.

# LPI series

## Tactile pushbutton switches with large actuator

Operator

### BEZEL COLOUR

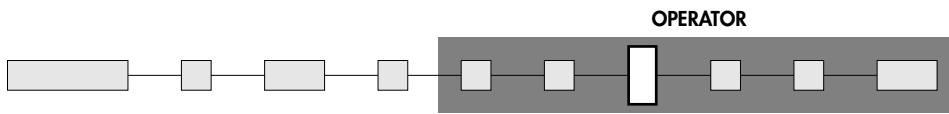

- X No bezel
- 1 Blue
- 2 Black
- 3 Green
- 4 Grey
- 5 Yellow
- 6 Red
- 7/1 White
- 9 Orange



Satin grey (option N) : consult APEM.

For sealed versions, the bezel is compulsory.

### ACTUATOR TYPE

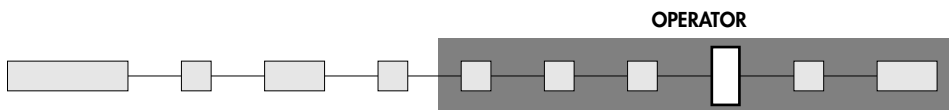

- 1 Stainless steel raised crimped symbol
- 2 Raised moulded symbol (star and bell)
- 3 Raised screen printed symbol
- 4 Without symbol
- 5 Screen printed symbol

Ring illumination available with options 3, 4 and 5 only.

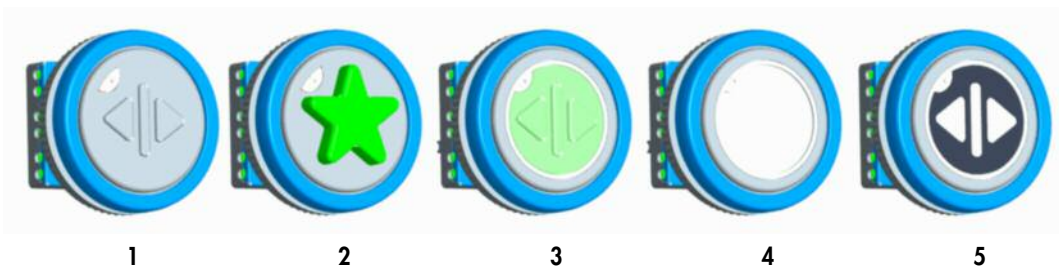

### ACTUATOR COLOR

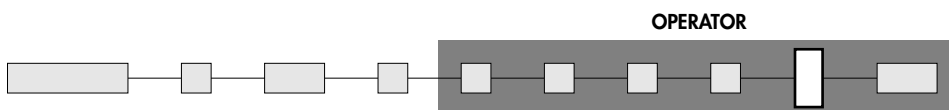

- 7 White



# LPI series

## Tactile pushbutton switches with large actuator

Operator

### ACTUATOR MARKING

#### OPERATOR

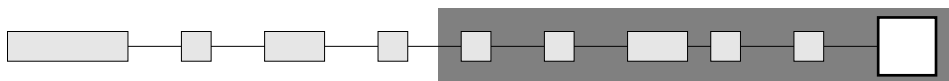

CODE	SYMBOL	DESCRIPTION
XX	/	No symbol
00	0	
01	1	
02	2	
03	3	
04	4	
05	5•	With single tactile point
06	6	
07	7	
08	8	
09	9	
11	-1	
12	-2	
13	-3	

CODE	SYMBOL	DESCRIPTION
14	◀▶	Open
15	▶◀	Close
16	△	Up
17	▽	Down
18	◁	Left
19	▷	Right
20	☼	Ventilation
21	🔔	Alarm (moulded, yellow)
22	★	Exit level (moulded, green)
23	☎	Phone

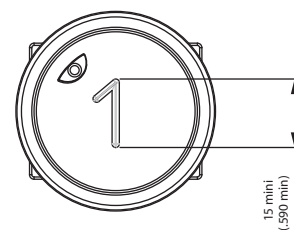
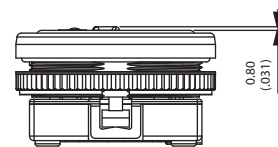

Actuator type 1

	Symbol height		
	Symbol 21	Symbol 22	Other symbol
Actuator type 1	x	x	0,8 mm
Actuator type 2	0,8 mm	5 mm	x
Actuator type 3	x	x	0,8 mm
Actuator type 4	x	x	x
Actuator type 5	x	x	0 mm

x = non available



Компания «Океан Электроники» предлагает заключение долгосрочных отношений при поставках импортных электронных компонентов на взаимовыгодных условиях!

Наши преимущества:

- Поставка оригинальных импортных электронных компонентов напрямую с производств Америки, Европы и Азии, а так же с крупнейших складов мира;
- Широкая линейка поставок активных и пассивных импортных электронных компонентов (более 30 млн. наименований);
- Поставка сложных, дефицитных, либо снятых с производства позиций;
- Оперативные сроки поставки под заказ (от 5 рабочих дней);
- Экспресс доставка в любую точку России;
- Помощь Конструкторского Отдела и консультации квалифицированных инженеров;
- Техническая поддержка проекта, помощь в подборе аналогов, поставка прототипов;
- Поставка электронных компонентов под контролем ВП;
- Система менеджмента качества сертифицирована по Международному стандарту ISO 9001;
- При необходимости вся продукция военного и аэрокосмического назначения проходит испытания и сертификацию в лаборатории (по согласованию с заказчиком);
- Поставка специализированных компонентов военного и аэрокосмического уровня качества (Xilinx, Altera, Analog Devices, Intersil, Interpoint, Microsemi, Actel, Aeroflex, Peregrine, VPT, Syfer, Eurofarad, Texas Instruments, MS Kennedy, Miteq, Cobham, E2V, MA-COM, Hittite, Mini-Circuits, General Dynamics и др.);

Компания «Океан Электроники» является официальным дистрибьютором и эксклюзивным представителем в России одного из крупнейших производителей разъемов военного и аэрокосмического назначения «JONHON», а так же официальным дистрибьютором и эксклюзивным представителем в России производителя высокотехнологичных и надежных решений для передачи СВЧ сигналов «FORSTAR».



## JONHON

«JONHON» (основан в 1970 г.)

Разъемы специального, военного и аэрокосмического назначения:

(Применяются в военной, авиационной, аэрокосмической, морской, железнодорожной, горно- и нефтедобывающей отраслях промышленности)

«FORSTAR» (основан в 1998 г.)

ВЧ соединители, коаксиальные кабели, кабельные сборки и микроволновые компоненты:

(Применяются в телекоммуникациях гражданского и специального назначения, в средствах связи, РЛС, а так же военной, авиационной и аэрокосмической отраслях промышленности).



Телефон: 8 (812) 309-75-97 (многоканальный)

Факс: 8 (812) 320-03-32

Электронная почта: [ocean@oceanchips.ru](mailto:ocean@oceanchips.ru)

Web: <http://oceanchips.ru/>

Адрес: 198099, г. Санкт-Петербург, ул. Калинина, д. 2, корп. 4, лит. А