



Cable to Board (Standard Footprint)

.050"

9 thru 100 Contacts

Rugged Cable

MM, MN

Rugged Board Mount

MK, ML

MM-312-051-161-45WP
(METAL)

MN-311-051-161-45WP
(PLASTIC)

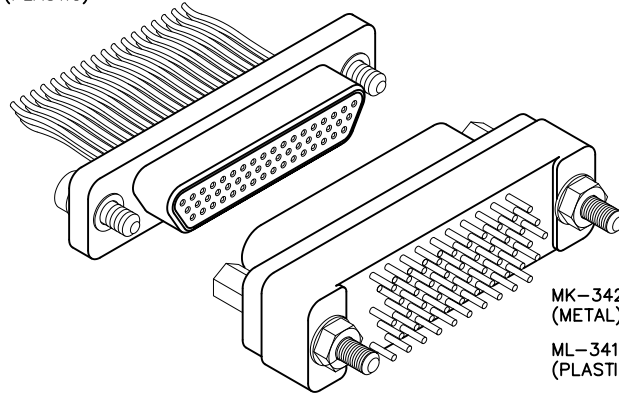

MK-342-051-225-2200
(METAL)

ML-341-051-225-2200
(PLASTIC)

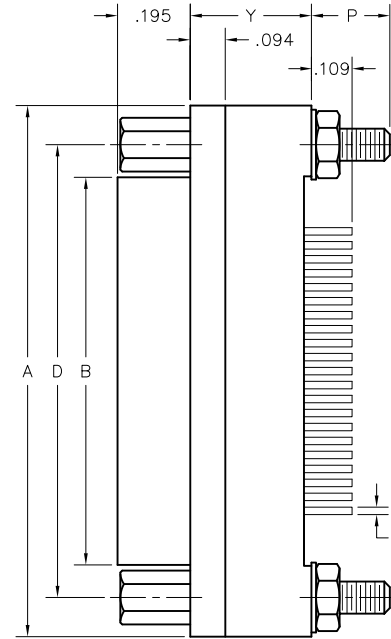
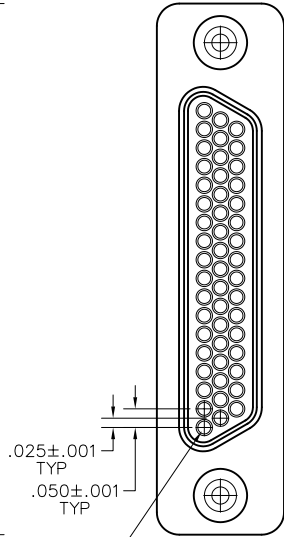
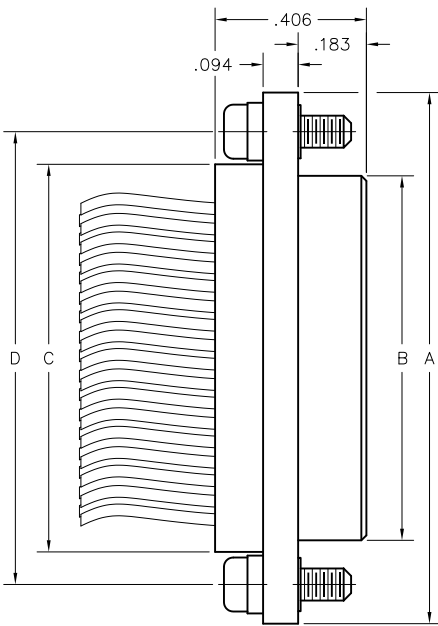

.020±.001
DIA TYP

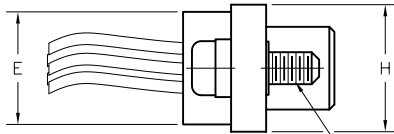

#2-56 CAPTIVE
JACKSCREW (2 PLCS)
SEE PAGE MA-5

PLUG

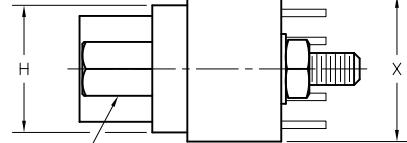

#2-56 JACKPOST
(2 PLCS)
SEE PAGE MA-5

RECEPTACLE

SIZE	CONTACT ROWS	DIMENSIONS										HARDWARE	
		A	B		C	D	E		H	P	X		Y
		PLUG MAX	RCPT MAX			POTTING WELL MAX							
9	2	.775	.334	.400	.390	.565	.270	.298	.210	.298	.280	.390	#2-56 UNC THD (#2-56 CLEARANCE OR #2-56 UNC THREADED INSERT)
15		.925	.484	.550	.540	.715						.540	
21		1.075	.634	.700	.690	.865						.690	
25		1.175	.734	.800	.790	.965						.780	
31		1.325	.884	.950	.940	1.115						.930	
37	1.475	1.034	1.100	1.090	1.265	.330**	1.080						
51	3	1.425	.984	1.050	1.040	1.215	.310	.341	.219	.390	.325	1.046	#4-40 UNC THD (#4-40 CLEARANCE OR #4-40 UNC THREADED INSERT)
69		1.725	1.284	1.350	1.340	1.515						1.346	
100		2.160	1.384	1.508	1.432	1.800						.360	

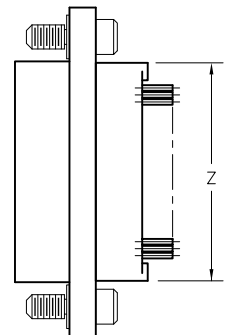

* = 69 POSITION CONNECTORS ARE AVAILABLE IN METAL ONLY.
 ** = 37 POSITION WITH TURNING HARDWARE "Y" DIMENSION IS .280.
 *** = "Z" DIMENSION FOR TURNING JACKSCREW ONLY

Call (972) 931-3200 Fax (972) 931-9305 www.AirBorn.com

PLUG: MM-312-051-161-45WP
RECEPTACLE: MK-342-051-225-2200
PLUG: MN-311-051-161-45WP
RECEPTACLE: ML-341-051-225-2200
 XX-XXX-XXX-XXX-XXXX-XXX

PLUG

RECEPTACLE

SERIES

MM .050" Rugged Metal I/O Connector MN .050" Rugged Plastic I/O Connector (MM & MN mate with MK, ML, MM, MN receptacles)	MK .050" Rugged Metal PC Board Mount Connector ML .050" Rugged Plastic PC Board Mount Connector (MK & ML mate with MK, ML, MM, MN plugs)
--	--

BODY

2 2-Row (Sizes 9 thru 37) 3 3-Row (Size 51 & 69***) 4 4-Row (Size 100)	2 2-Row (Sizes 9 thru 37) 3 3-Row (Size 51 & 69***) 4 4-Row (Size 100)
--	--

BODY STYLE: 1 Plug, straight, with ears	BODY STYLE: 4 Receptacle, straight, standard footprint
---	--

BODY MATERIAL: 1 Polyphenylene Sulfide (MN only) 2 Polyphenylene Sulfide with electroless nickel shell 3 Polyphenylene Sulfide with electrodeposited cadmium shell <input checked="" type="checkbox"/> 4 Polyphenylene Sulfide with hard anodized black shell 5 Polyphenylene Sulfide with stainless steel shell	BODY MATERIAL: 1 Polyphenylene Sulfide (ML only) 2 Polyphenylene Sulfide with electroless nickel shell 3 Polyphenylene Sulfide with electrodeposited cadmium shell <input checked="" type="checkbox"/> 4 Polyphenylene Sulfide with hard anodized black shell 5 Polyphenylene Sulfide with stainless steel shell
--	--

SIZE

XXX 009, 015, 021, 025, 031, 037, 051, 069***, 100	XXX 009, 015, 021, 025, 031, 037, 051, 069***, 100
--	--

CONTACTS

TYPE CONTACTS/TERMINATIONS: 11 Pin, straight, solder cup 14 Pin, straight, .500" pigtails (.018 dia) 15 Pin, straight, 1.000" pigtails (.018 dia) 16 Pin, straight, crimped wire	TYPE CONTACTS/TERMINATIONS: 22 Socket, straight, PCB leads, .109" 23 Socket, straight, PCB leads, .140" 24 Socket, straight, PCB leads, .172"
---	---

PLATING OPTIONS: 1 50 μ" Au contacts (crimp wire) 3 50 μ" Au contacts; 10 μ" Au terminations (solder cup, pigtail) 5 50 μ" Au contacts; Sn/Pb alloy terminations (pigtail) <input checked="" type="checkbox"/> 7 50 μ" Au contacts; SAC305 terminations (pigtail)	PLATING OPTIONS: 3 50 μ" Au contacts; 10 μ" Au terminations 5 50 μ" Au contacts; Sn/Pb alloy terminations <input checked="" type="checkbox"/> 7 50 μ" Au contacts; SAC305 terminations
--	--

HARDWARE

STYLE OF HARDWARE: 00 None 22 Two fixed jacknut assemblies (62*) 41 Two turning jackscrews, allen head, retaining ring (81*) 42 Two long turning jackscrews, allen head, retaining ring (82*) 43 Two turning jackscrews, slot head, retaining ring (83*) 44 Two long turning jackscrews, slot head, retaining ring (84*) 45 Two turning jackscrews, allen head, captivated** (85*) 99 Keying hardware, see options below (Body material 2, 3 and 4 only)	STYLE OF HARDWARE: 00 None 22 Two fixed jacknut assemblies (62*) 41 Two turning jackscrews, allen head, retaining ring**** (81*) 99 Keying hardware, see options below (Body material 2, 3 and 4 only)
---	---

POLARIZATION / WIRING: 00 None XX For wiring codes, see page MA-3 & MA-4	POLARIZATION / WIRING 00 None
---	---

OPTIONS

KSXX Two turning jackscrews. See page MA-6 for keying options (KJ*)	KPXX Two fixed jacknuts and interfacial sealing gasket. See page MA-6 for keying options (KN*) 900 Interfacial sealing gasket 0B7 Threaded inserts and interfacial sealing gasket
---	---

* = Use numbers or letters in parenthesis when ordering size 100. *** = 69 position connectors are available in metal only.
 ** = Captive hardware is factory installed and non-removable. **** = Connector body has no mounting holes.
 = Option not RoHS compliant

Компания «Океан Электроники» предлагает заключение долгосрочных отношений при поставках импортных электронных компонентов на взаимовыгодных условиях!

Наши преимущества:

- Поставка оригинальных импортных электронных компонентов напрямую с производств Америки, Европы и Азии, а так же с крупнейших складов мира;
- Широкая линейка поставок активных и пассивных импортных электронных компонентов (более 30 млн. наименований);
- Поставка сложных, дефицитных, либо снятых с производства позиций;
- Оперативные сроки поставки под заказ (от 5 рабочих дней);
- Экспресс доставка в любую точку России;
- Помощь Конструкторского Отдела и консультации квалифицированных инженеров;
- Техническая поддержка проекта, помощь в подборе аналогов, поставка прототипов;
- Поставка электронных компонентов под контролем ВП;
- Система менеджмента качества сертифицирована по Международному стандарту ISO 9001;
- При необходимости вся продукция военного и аэрокосмического назначения проходит испытания и сертификацию в лаборатории (по согласованию с заказчиком);
- Поставка специализированных компонентов военного и аэрокосмического уровня качества (Xilinx, Altera, Analog Devices, Intersil, Interpoint, Microsemi, Actel, Aeroflex, Peregrine, VPT, Syfer, Eurofarad, Texas Instruments, MS Kennedy, Miteq, Cobham, E2V, MA-COM, Hittite, Mini-Circuits, General Dynamics и др.);

Компания «Океан Электроники» является официальным дистрибьютором и эксклюзивным представителем в России одного из крупнейших производителей разъемов военного и аэрокосмического назначения «**JONHON**», а так же официальным дистрибьютором и эксклюзивным представителем в России производителя высокотехнологичных и надежных решений для передачи СВЧ сигналов «**FORSTAR**».



JONHON

«**JONHON**» (основан в 1970 г.)

Разъемы специального, военного и аэрокосмического назначения:

(Применяются в военной, авиационной, аэрокосмической, морской, железнодорожной, горно- и нефтедобывающей отраслях промышленности)

«**FORSTAR**» (основан в 1998 г.)

ВЧ соединители, коаксиальные кабели, кабельные сборки и микроволновые компоненты:

(Применяются в телекоммуникациях гражданского и специального назначения, в средствах связи, РЛС, а так же военной, авиационной и аэрокосмической отраслях промышленности).



Телефон: 8 (812) 309-75-97 (многоканальный)

Факс: 8 (812) 320-03-32

Электронная почта: ocean@oceanchips.ru

Web: <http://oceanchips.ru/>

Адрес: 198099, г. Санкт-Петербург, ул. Калинина, д. 2, корп. 4, лит. А