



Hermetically sealed cell

83151



HERMETICALLY SEALED MICROSWITCHES SINGLE POLE, CHANGEOVER TYPES 83 151 (150°C) AND DERIVATIVES

PRESENTATION

This is the basic component for our whole range of standard 1-pole and 2-poles hermetically-sealed limit switches plus the 3-poles version (special Umit Switches).

The CROUZET hermetic microswitch combines a snap-action switching system with high resistance to shock and vibration in an hermetically sealed miniature case which encloses an atmosphere of inert gas around its contacts, ideal for switching very low level circuits and higher currents also.

The meticulous care taken in the manufacture of this hermetically sealed cell in terms of assembly processes, cleanliness of components as well as inspection procedures, result in a product which is ideal for operation in severe environments where a high level of reliability is essential.

The CROUZET hermetically sealed cell is particularly well suited to sectors such as Aerospace, Armaments, Marine, Nuclear, etc.

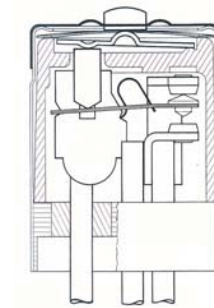
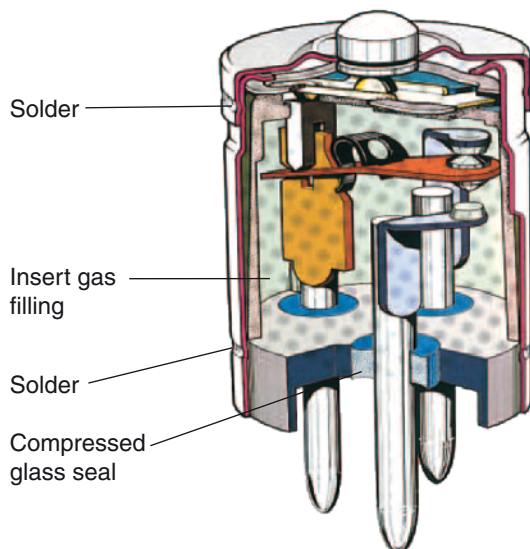
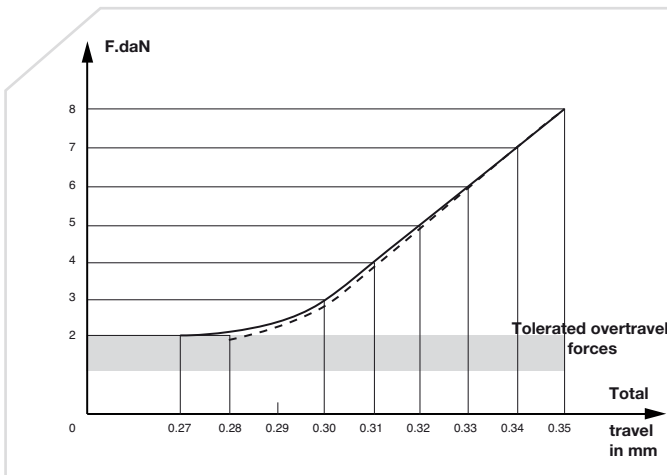

Diagram of snap-action device

ESSENTIAL CHARACTERISTICS

- Switching power from 1 mA to 7 A.
- Operating temperature: -55°C to 150°C : Type 83 151
-55 °C to 250°C : Type 83 1512
- Operating pressure : 1 bar : Type 83 151
From 2 to 6 bars : Type 83 1515
- Vibration resistant up to 80 g.
- Shock resistant up to 200 g.
- High level of hermetic sealing: Leakage <math> < 1 \times 10^{-6} \text{ cm}^3 \text{ He/S}</math>
- Long life: 200,000 cycles.
- Small size: \varnothing 11 x 16.
- Numerous single pole and multipoles operating and fixing options.

DISTINCTIVE CHARACTERISTICS



Mechanical strength

No abrupt increase in the total travel of the device is noted under rising overtravel forces of up to 80 N. On return to a normal overtravel force of 20 N after these measurements have been carried out on one and the same device, the total travel will be observed to have varied only very little (low permanent set).

The device can be damaged if the overtravel force is pushed up to 150 N.

Hermetic sealing

- The microswitch is filled with inert gas (nitrogen-hydrogen mixture), the internal pressure being 1 bar.
- The hermetic sealing (membrane-cap - cap-base) is achieved with a continuous seam welding bead.
- 1×10^{-8} atm cm^3/s

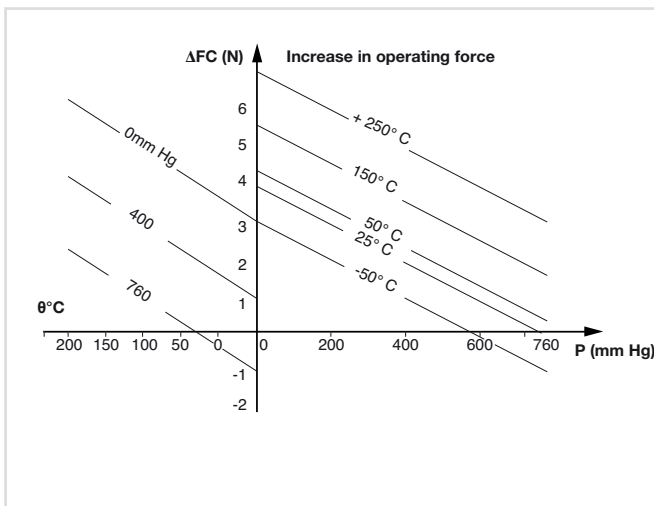

Change in operating force as a function of ambient temperature and pressure.

The force values of our hermetically sealed microswitches are influenced by ambient pressure and temperature; we give the value, for the base cell, for the increase in operating force (Δ OF) as a function of these two parameters.

The characteristics are stated for normal temperature (23°C) and atmospheric pressure at sea level (760 mm Hg).

Our hermetically sealed microswitches can be used from atmospheric pressure to absolute vacuum; some variants allow use at higher pressures.

Reliability of characteristics

Below are two test extracts showing the stability of the essential characteristics over time and as a function of temperature.

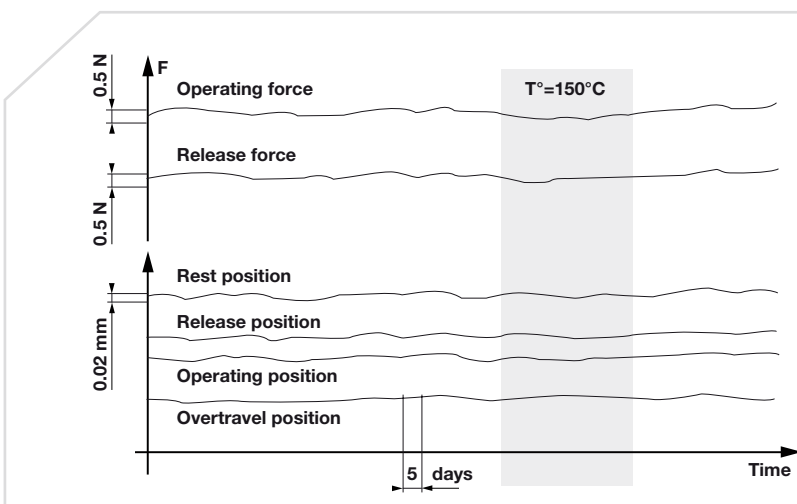

Travels and forces

Change in the characteristics concerned under a constant load of 25 Newtons applied to the operating device.

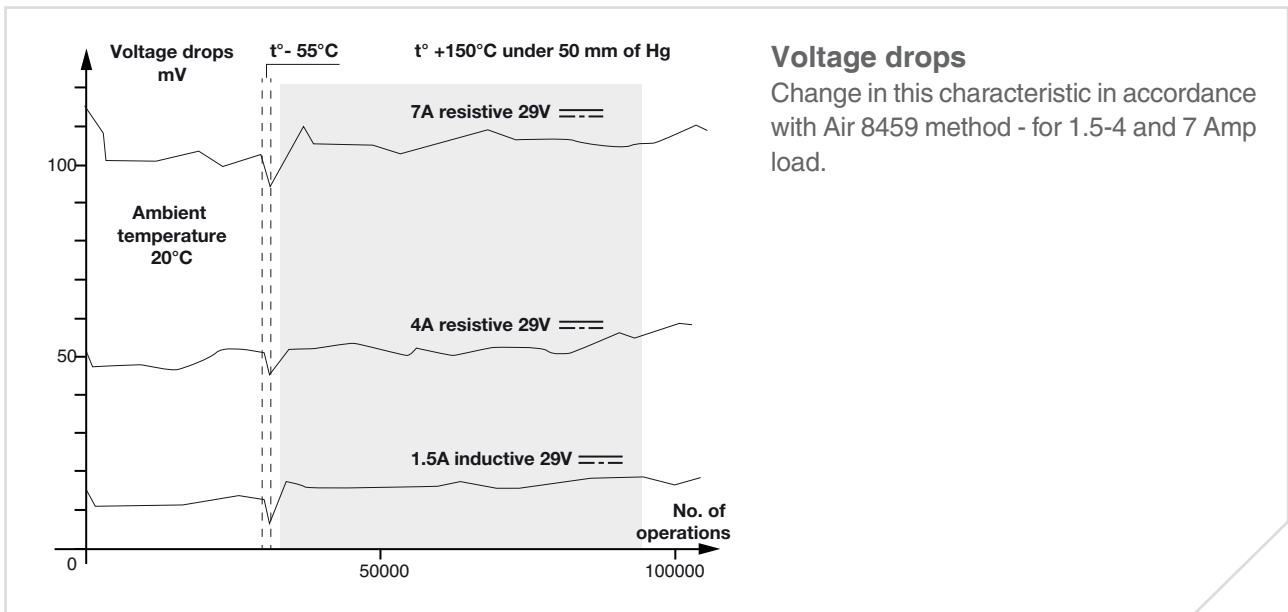

CONNECTIONS

Electrical connections are made through the base, by three ferronickel terminals, with copper core, sealed by compressed glass.

Welded

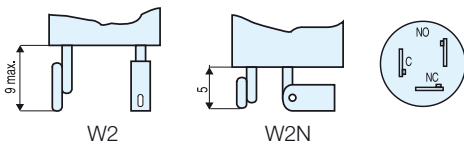

Wired

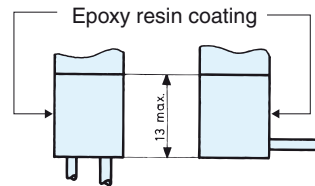

parallel to axis (//) perpendicular to axis (⊥)

Electrical diagram (actuator at rest position)



Wires: 0.38 mm² Air 4524 - length 0.50 m.
Category 140° 170°C.

Dimensions

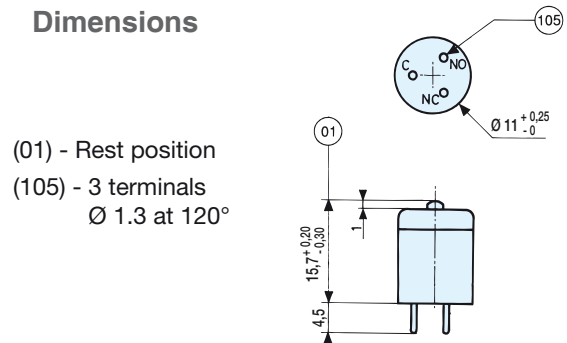

PERFORMANCE DATA

Product characteristics	Value	Unit	Under
Min. current	1	mA	5 V DC
Nominal current			
Resistive	3	A	48 V DC ⁽¹⁾
Lamp	1	A	115 V - 400 Hz
Lamp	2	A	30 V DC ⁽¹⁾
Resistive	3	A	30 V DC ⁽¹⁾
Inductive L/R = 0.005 s	1.5	A	30 V DC ⁽¹⁾
Resistive	1	A	220 V AC
Inductive - cos φ 0.8	0.4	A	220 V AC
Service life at nominal current ⁽³⁾ - cycles	200 000		
Dielectric rigidity between connections and earth	1200	V	
Rigidity between connections	1000	V	
Insulation resistance (at 500 V DC)	100	MΩ	
Voltage drop at 1 A ⁽²⁾	0.02	V	
Operating temperature	-55 +150	°C	
Shock resistance ⁽³⁾	200/11	g/ms	
Vibration resistance	80/20 → 2000	g/Hz	

(1) For a service life of 100,000 cycles - Permitted current 4 A inductive 7 A resistive in contactor or breaker.
(2) Over welded connections - for wired connections add 0.1 V per metre.
(3) Value for microswitch without auxiliary actuator

HERMETICALLY SEALED MICROSWITCHES

WITH ACCESSORIES (BASIC CELL -55° +150°C 83 151 001)

Part numbers

Soldered connections	W2	83 151 012	83 151 014	83 151 013
	W2 N	83 151 042	83 151 044	83 151 043
Wire 0.38 mm ² 0.5 m long	with parallel wires	83 151 022	83 151 024	83 151 023
	with perpendicular wires	83 151 032	83 151 034	83 151 033
Mounting	by flange	•	•	
	by threaded barrel			•
	reinforced			
Control	via simple actuator			
	via roller actuator			

Characteristics

Max. operating force	N	10	10	10
Min. release force	N	1.5	1.5	1.5
Permitted overtravel force	N	20	20	20
Positive overtravel stop				
Service life (operations - min)		200 000	200 000	200 000
Max. pre-travel	mm	0.25	0.25	0.25
Max. differential travel	mm	0.05	0.05	0.05
Min. overtravel	mm	0.08	0.08	0.08
Weight (without wires)	g	5	5	13

Dimensions

Add the dimensions of the various connections to find the total dimensions

► indicates the wire direction

01 - Tripping point

111 - Nut h 2.5 x 17/flat

Panel cut-out

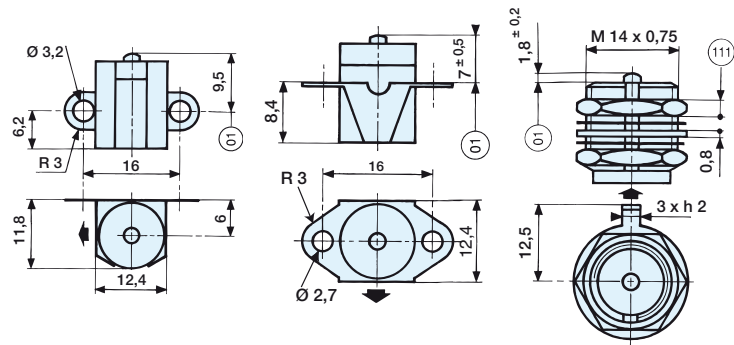
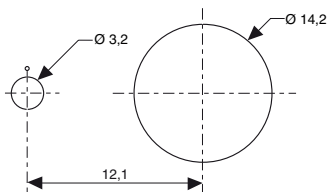

HERMETICALLY SEALED MICROSWITCHES HIGH PRESSURE FROM 2 TO 6 BARS

These variants of the basic type 83 151 feature a compensating system which allow them to be used at pressures above atmospheric.

(for other characteristics please refer to basic model type 83 151 0)

Characteristics			
Permitted pressure	Bar	2	6
Operating force max.	N	25	47
Overtravel max. - force *	N	45	80
Release force min. *	N	11	22
Weight (without leads) *	g	8,5	8,5

* Figures at atmospheric pressure at ground level

Dimensions

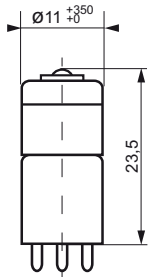

Connections

W2 Ref. 83151504
W2N Ref. 83 151 503

HERMETICALLY SEALED MICROSWITCHES SINGLE POLE, CHANGEOVER TYPES 83 151 (250°) AND DERIVATIVES

WITHOUT ACCESSORIES (BASIC CELL -55° +250°C 83 151 201)

This basic component is the same design as the 83 151 001 standard cell but is adapted for operation in high temperatures up to 250 °C.

Characteristics	Unit	Value
Nominal current at 30 VDC		
Resistive	A	1
Inductive L/R = 5 ms	A	1
Service life at nominal current (min. operations)	Min. operations	20 000 / 100 000
Voltage drop at 1 A ⁽¹⁾	V	0.06
Max. operating force ⁽²⁾	N	14
Min. release force	N	1.5
Max. permitted overtravel force	N	20
Max. pre-travel	mm	0.25
Max. differential travel	mm	0.05
Min. overtravel	mm	0.08
Weight (without wires)	g	13

(1) On soldered connections. For wired connections add 0.18 V per metre. Category 250°, 280°.

(2) Characteristics at : $\theta = 250^{\circ}\text{C}$ atmospheric pressure at ground level.

Connections

With wires : 500 mm of length or soldered terminals

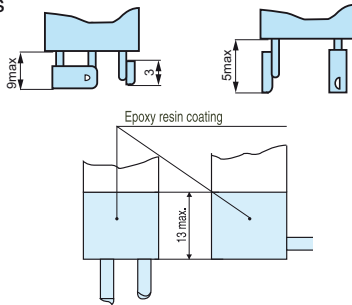

Dimensions

01 - Rest position
105 - 3 terminals $\varnothing 1.3$ at 120°

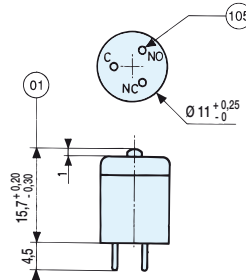

Electrical diagram

114 - C
115 - NC
116 - NO

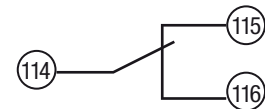

WITH ACCESSORIES (BASIC CELL -55° +250°C 83 151 201)

Control accessories equipped with type 83 151 201 sensitive changeover

Part numbers

	SINGLE-POLE	SINGLE-POLE
W2 terminals output	83 151 212	83 151 213
// wires output	83 151 222	83 151 223
⊥ wires output	83 151 232	83 151 233
W 2 N terminals output	83 151 242	83 151 243
Weight without wires	6 g	13 g

Add the dimensions of the various connections for the total dimensions. The mechanical characteristics are those of the 83 151 201 changeover.

► indicates the direction of the wires.

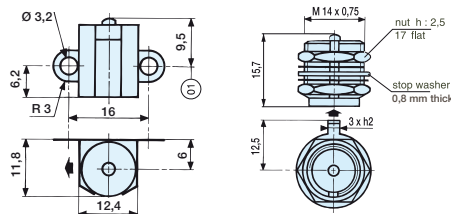

Panel cut-out

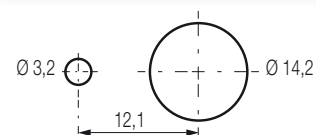

LIMIT SWITCHES BASED ON HERMETICALLY SEALED MICROSWITCHES (250°)

WITHOUT ACCESSORIES (BASIC CELL -55° +250°C 83 151 201)

Part numbers

	SINGLE-POLE
W2 terminals output	83 770 211
// wires output	83 770 221
⊥ wires output	83 770 231
W 2 N terminals output	83 770 241

Add the dimensions of the various connections to find the total dimensions

Mechanical characteristics :

- Max. operating force 22 N
- Min. release force 1.5 N
- Max. permitted overtravel force 50 N positive overtravel stop
- Pre-travel 0.1 to 0.3 mm
- Max. differential travel 0.05 mm
- Min. overtravel 3 mm
- Weight without wires 20 g

► indicates the direction of the wires

Panel cut-out

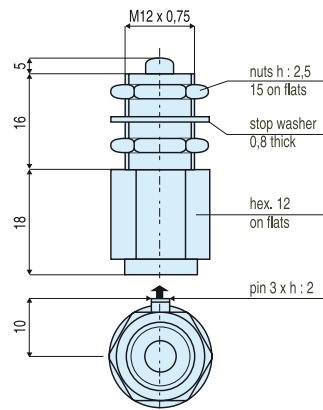
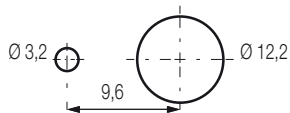

LIMIT SWITCHES BASED ON HERMETICALLY SEALED MICROSWITCHES (150°)

MECHANICAL CAPACITY

We adapt the telescopic sub-assemblies for our hermetically sealed limit switches according to pressure and operating temperature requirements. Our products can therefore be used at atmospheric pressure or in an absolute vacuum and at a temperature of -50° to +250°C (depending on the type of hermetically sealed basic cell).

BASIC CELL -55° +150°C 83 151 001

Part numbers			
Soldered connections	W2		83 770 012
	W2 N		83 770 042
Wire 0.38 mm ² 0.50 m long	with parallel wires		83 770 022
	with perpendicular wires		83 770 032
Control simple plunger	single-pole		•
	two-poles		
With single-pole ball plunger			
With single-pole roller plunger			

Characteristics	Unit	Value
Max operating force	N	12
Min. release force	N	1.5
Permitted overtravel force	N	20
Positive overtravel stop		
Max. pre-travel	mm	0.3
Max. differential travel	mm	0.05
Min. overtravel	mm	1
Resistance to shocks	g/ms	100/11
Resistance to vibrations	g/Hz	50/800 → 2000
Weight (without wires)	g	21
Service life (operations - min)		100 000

Panel cut-out

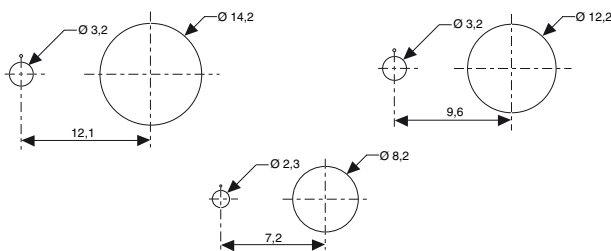

Dimensions

Add the dimensions of the various connections for the total dimensions
 ► indicates the direction of the wires

- 30 - Ball bearing Ø 3
- 106 - Nut h 2 - 11 / flat
- 107 - Stop washer - 0.8 thick
- 112 - Locating pin- h.2
- 120 - Nut h 2.5 - 15 / flat
- 111 - Nut h 2.5 - 17 / flat

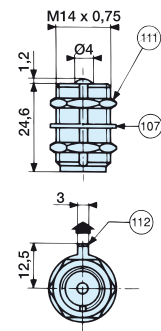

Connections

Welded

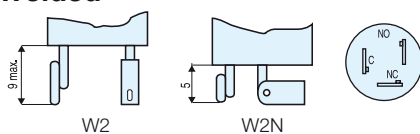

Wired

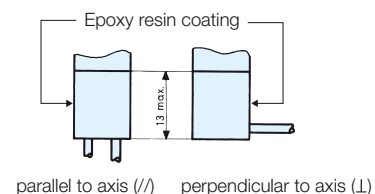

83 770 011	83 770 014	83 770 015	83 771 011
83 770 041	83 770 044	83 770 045	83 771 041
83 770 021	83 770 024	83 770 025	83 771 021
83 770 031	83 770 034	83 770 035	83 771 031
•			•
	•		
		•	

12	12	12	30
1.5	1.5	1.5	3
50	50	50	80
•	•	•	•
0.3	0.3	0.3	0.5
0.05	0.05	0.05	0.15
3	3	3	5
100/11	100/11	100/11	100/11
50/800 → 2000	50/800 → 2000	50/800 → 2000	50/800 → 2000
15	15.5	20	47.5
100 000	100 000	100 000	100 000

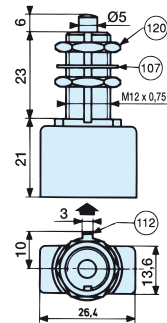
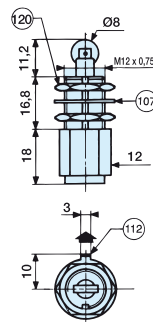
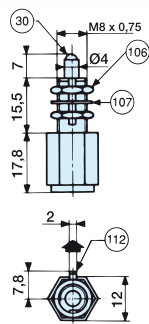
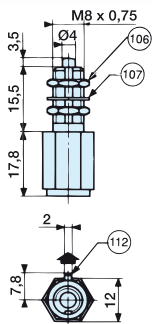

Electrical diagram (actuator at rest)

green wire C



NC black wire

NO red wire

Wires: 0.38 mm² - length 0.50 m.

Category 140° 170°C.

In dimension diagrams ► indicates the orientation of the wires.

Investigation tests

K1 EDF HM63/10466-PF/ET

 To view the original document, see page 124.

**ELECTRICITE DE FRANCE
RESEARCH & DESIGN DEPARTMENT**

Electrical Equipment Department

Les Renardières, route de Sens
ECUELLES
BP No. 1 – 77520 MORET-SUR-LOING
Tel: (6) 070-68-20

CROUZET
Division Composants d'Automatisme
25 rue Jules Védrines
26027 VALENCE CEDEX

**Project led by Mr FREMONT
Tel: 070.65.87**

For the attention of MR FRACHISSE

Yr Ref:

Our Ref: HM63/10466-PF/ET

Re: K1 investigation tests
SP 48-16 sensitive switches

LES RENARDIERES 8 JUL 1983

Dear Sirs

Please find enclosed two copies of the reports on the tests to which we have subjected your SP 48-16 sensitive switches.

These tests demonstrated that the hermetically sealed cell 83 151 506 (6 bar) satisfied the operating and environmental conditions (especially in accidents) required for K1 safety equipment.

However, they have led to modifications being made to the connection method and control system:

- single-wire connection with STYCAST 2651 resin filler/Catalyst 9
- stiffener on the operating lever to reduce the sensitivity to vibrations with extension of this lever to reduce the actuating force

Yours faithfully

Ph. ROUSSARIE

Head of the "DC, Insulated Cables, Materials for Electrical Engineering, Automation Equipment" Department

Enc. 2 copies of note HM63/8057
2 copies of note HM63/8064
2 copies of note HM63/8065

1 copy sent to M.Petit PARIS

R.C. PARIS B 552 081 317

CEN SACLAY

radiation hardness test report



To view the original document, see page 124.

TECHNICATOME

MAN/73/014

C.E.N. SACLAY

REACTOR CONSTRUCTION DIVISION

DEPARTMENT: D.E.F.

SECTION: HANDLING

WITHSTAND TO GAMMA RAYS OF ELECTRICAL COMPONENTS SUCH AS MICROSWITCHES FOR USE IN HOT CELLS

CONTENTS

- 1 – SUBJECT
- 2 – CHARACTERISTICS OF HERMETICALLY SEALED CELLS BEFORE IRRADIATION
- 3 – OPERATING CONDITIONS OF HERMETICALLY SEALED CELLS
- 4 – IRRADIATION (test conditions)
- 5 – CHARACTERISTICS OF HERMETICALLY SEALED CELLS AFTER IRRADIATION
- 6 – CONCLUSION

DIAGRAMS

- 1 – IRRADIATOR
- 2 – SOURCE
- 3 – PAGURE CELL (C.A.P.R.I.)
- 4 – HERMETICALLY SEALED CELL REF: 83-151-001 (CROUZET)

1 – SUBJECT

Tests were conducted to determine the withstand to GAMMA rays (integral dose of 10 rads) of CROUZET microswitch type electrical components (hermetically sealed cells) that might be suitable for installing in the irradiated component cell of the PHENIX reactor, a 100 kilocurie $\alpha - \beta - \gamma$ type cell.

2 – CHARACTERISTICS OF HERMETICALLY SEALED CELLS BEFORE IRRADIATION

These hermetically sealed cells are fully sealed microswitches, filled with inert gas (hydrogenated nitrogen) at a pressure of 1 bar.

Part number: 83-151-001

Materials used (see diagram IV)

1) Cover:	Z 5 CN 18-08 (annealed)
2) Membrane:	Stainless steel 18-08 Arc 2702 S
3) Plunger:	Stainless steel 18-08 with sulphur
4) Plunger washer:	Z CR 177 (annealed)
- Terminals:	5) 48% Ferronickel baseplate
	6) Fritted glass pearls
	7) Ferronickel terminals with copper core and 5 micron electroless nickel plating
8) Common terminal:	UZ 22 N 18 3/4 cold-rolled nickel silver, gold-plated with 3 to 4 microns
9)Top terminal}	1/2 hard nickel silver
10)Bottom terminal}	
11)Contact:	Ag graphite 5/1000
12)Bell insulator:	Micaver
13)Plunger:	Micaver
14)Lever:	Z 12 CN 18/10 – 3/4 hard
15:Spring washer:	ZCR 177 cold-rolled 150 kg/mm ²
16:Wire bundle:	Epoxy resin – Stycast 2651
17:Wires:	Filotex 1800

3 – OPERATING CONDITIONS OF HERMETICALLY SEALED CELLS

In the irradiated component cell of the PHENIX reactor:

- Atmosphere:	Nitrogen with 2% max. oxygen content
- Pressure:	2 mbar
- Temperature:	50°C approx.
- Relative humidity:	2% max.
- Maximum dose rate:	≤ 5.105 R/hr

4 – IRRADIATION (test conditions)

- Date:	from 15/03/1972 to 10/04/10972
- Place:	PAGURE cell (CAPRI) at C.E.N./SACLAY
- Source:	20,000 curies of cobalt 60 – consisting of 10 bars of 2000 Ci
- Atmosphere:	Air
- Pressure:	Atmospheric
- Temperature:	20°C approx.
- Relative humidity:	60% approx.
- Exposure dose:	1.078 109 rads
- Dose rate:	2.2 106 R/hr
- Duration:	490 hrs
- Distance:	in basket no. 2 (at the heart of the source)
- Integral dose:	almost equivalent to the exposure dose, ie. 1.078 109 rads.

NB: During its irradiation with γ rays, no endurance tests were conducted.

5 – CHARACTERISTICS OF HERMETICALLY SEALED CELLS AFTER IRRADIATION

Comparison of tests and results BEFORE and AFTER irradiation

TESTS	Cell no. 7344		Cell no. 7338	
	Before	After	Before	After
Differential travel	0.025	0.025	0.035	0.035
Overtravel	0.13	0.13	0.13	0.13
Overtravel after release	0.13	0.13	0.10	0.10
Total travel	0.28	0.28	0.27	0.27
Actuating force	540	550	540	520
Release force	360	360	340	320
Equilibrium point	NONE	NONE	NONE	NONE
Off/on burn-out	1450 - 1200	1450 - 1300	1450 - 1250	1400 - 1300
Voltage drop:				
- NC	10	8	10	7
- NO	9	7	9	6

6 – CONCLUSION

The test results highlight that the characteristics of the hermetically sealed cells have not undergone any significant change and that they are suitable for the operating conditions of the irradiated component cell in the PHENIX reactor.

However, it should be noted that no endurance tests were conducted with γ ray flux.

Компания «Океан Электроники» предлагает заключение долгосрочных отношений при поставках импортных электронных компонентов на взаимовыгодных условиях!

Наши преимущества:

- Поставка оригинальных импортных электронных компонентов напрямую с производств Америки, Европы и Азии, а так же с крупнейших складов мира;
- Широкая линейка поставок активных и пассивных импортных электронных компонентов (более 30 млн. наименований);
- Поставка сложных, дефицитных, либо снятых с производства позиций;
- Оперативные сроки поставки под заказ (от 5 рабочих дней);
- Экспресс доставка в любую точку России;
- Помощь Конструкторского Отдела и консультации квалифицированных инженеров;
- Техническая поддержка проекта, помощь в подборе аналогов, поставка прототипов;
- Поставка электронных компонентов под контролем ВП;
- Система менеджмента качества сертифицирована по Международному стандарту ISO 9001;
- При необходимости вся продукция военного и аэрокосмического назначения проходит испытания и сертификацию в лаборатории (по согласованию с заказчиком);
- Поставка специализированных компонентов военного и аэрокосмического уровня качества (Xilinx, Altera, Analog Devices, Intersil, Interpoint, Microsemi, Actel, Aeroflex, Peregrine, VPT, Syfer, Eurofarad, Texas Instruments, MS Kennedy, Miteq, Cobham, E2V, MA-COM, Hittite, Mini-Circuits, General Dynamics и др.);

Компания «Океан Электроники» является официальным дистрибьютором и эксклюзивным представителем в России одного из крупнейших производителей разъемов военного и аэрокосмического назначения «**JONHON**», а так же официальным дистрибьютором и эксклюзивным представителем в России производителя высокотехнологичных и надежных решений для передачи СВЧ сигналов «**FORSTAR**».



JONHON

«**JONHON**» (основан в 1970 г.)

Разъемы специального, военного и аэрокосмического назначения:

(Применяются в военной, авиационной, аэрокосмической, морской, железнодорожной, горно- и нефтедобывающей отраслях промышленности)

«**FORSTAR**» (основан в 1998 г.)

ВЧ соединители, коаксиальные кабели,
кабельные сборки и микроволновые компоненты:

(Применяются в телекоммуникациях гражданского и специального назначения, в средствах связи, РЛС, а так же военной, авиационной и аэрокосмической отраслях промышленности).



Телефон: 8 (812) 309-75-97 (многоканальный)

Факс: 8 (812) 320-03-32

Электронная почта: ocean@oceanchips.ru

Web: <http://oceanchips.ru/>

Адрес: 198099, г. Санкт-Петербург, ул. Калинина, д. 2, корп. 4, лит. А